

CHST48-7-MAPLE

FRONT VIEW

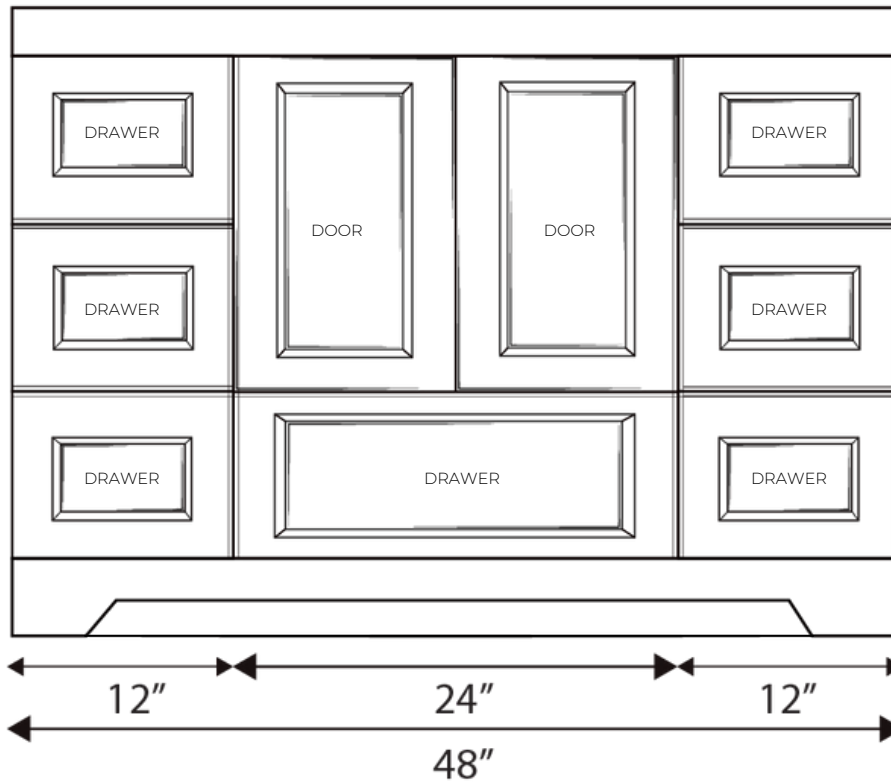

SIDE VIEW

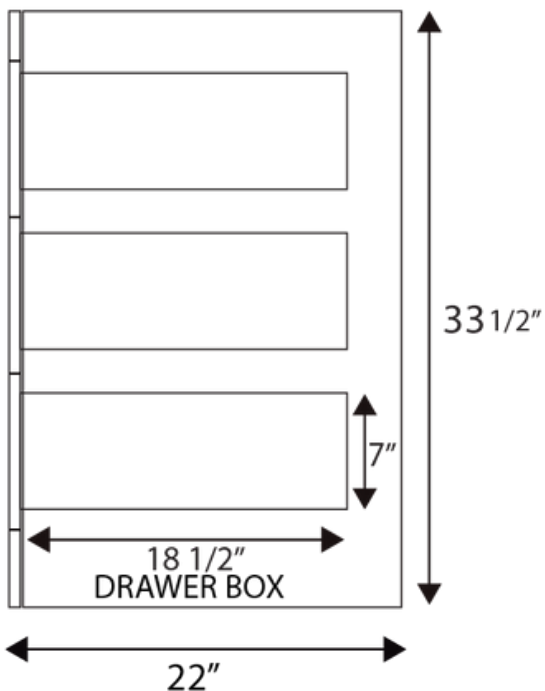

DIMENSIONS

CABINET

WIDTH	48"	1219 mm
HEIGHT	33.5"	851 mm
DEPTH	22"	558 mm

COUNTERTOP

LENGTH	49"	1245 mm
WIDTH	22.5"	571 mm

SINK (INNER)

LENGTH	12.4"	315 mm
WIDTH	18.75"	475 mm
DEPTH	7"	178 mm

COUNTERTOP

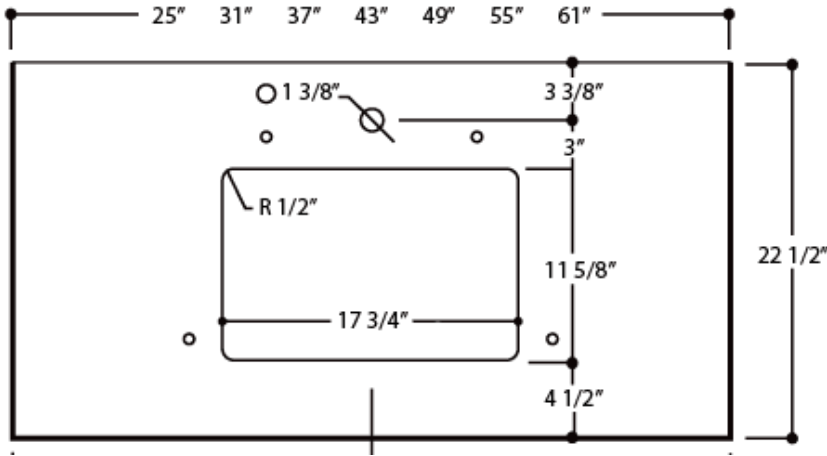

SINK

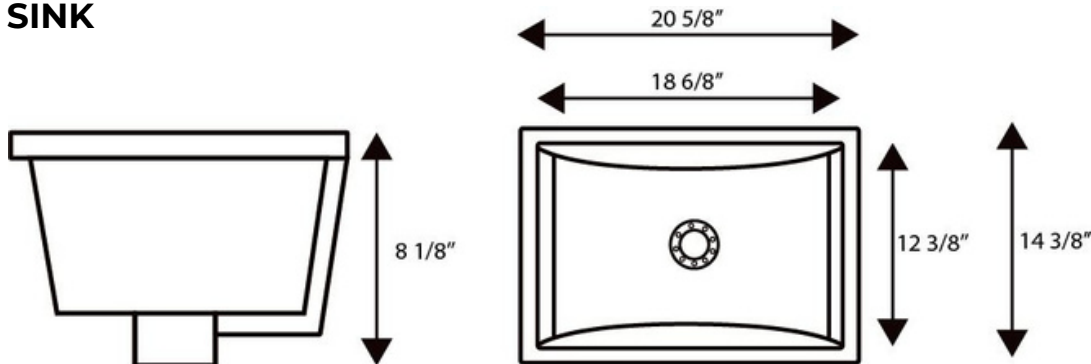

FEATURES

- Solid-wood drawers and doors
- Compressed wood cabinet box
- 7 operational drawers and 2 doors
- 2cm premium quartz countertop
- cUPC approved ceramic sink
- Matching quartz backsplash included
- Universal side-splash included
- 1/2" cabinet filler strip included
- Wood sealed for protection
- Requires minimal assembly