

TreoTM
Product Guide



Treo

is a contemporary and economical workspace solution for the open plan and private office. A core collection of products provide a multitude of solutions available in 22 different laminate finishes.



Treo Dual Workstation office consisting of an L-desk with return, hutch with doors, box/box/file pedestal, multi-storage open shelf wardrobe tower, and round meeting table with disc base.

Finishes—Nova White (NW) base and storage fronts, Ginger (GT) worksurfaces and storage cases, fabric tackboard, Box handle.



Treo Managerial Suite consisting of a Bow Top Desk with pedestals combined with a rear storage wall with hutch, file bookshelf towers, file/file pedestals
Finishes—Cocoa Bean (CB) base, worksurface and storage fronts, Nova White (NW) front modesty and hutch doors, frosted tower doors with anodized aluminum mitred frames, fabric tackboard, Box handle.



Contents

The trēo® System	1-2
How to Specify Finishes in trēo®	1-3
Layout Guides	
Layout Guides	1-4
Tops	
Regular and Bow Top Desks	1-10
Open and Executive Returns	1-12
Bridging and Linking Tops	1-13
Credenzas – Full Modesty	1-14
Credenzas – Partial Modesty	1-15
D Islands	1-16
P and K Islands	1-17
Rectangular Shells	1-18
Curved Shells – Left	1-20
Curved Shells – Right	1-21
Corner Tops	1-22
Extended Corner Tops – Left	1-23
Extended Corner Tops – Right	1-24
Extended Corner Tops / Islands with Keyboard	1-25
Extended Corner “D” – Left	1-26
Extended Corner “D” – Right	1-27
Storage	
Pedestals	1-28
Lateral File / Storage Units	1-29
Tall Lateral / Storage Units	1-30
Tall Multi-Storage Units	1-31
Storage Units	1-32
Tall Storage / Bookcases	1-33
Storage with Framed Translucent Doors	1-34
Hutches / Wall Bins	1-35
Hutches	1-36
Flipper Door Hutches / Tack Boards	1-37
Double Tier Hutches / Paper Management	1-38
Hutches with Framed Translucent Doors / Tack Boards	1-39
Specialty Items	
Specialty Storage	1-40
Meeting Room Accessories	1-41
Gallery / Reception Desks	1-43
Education Specialties	
Single / Linking Study Carrels	1-46
Double / Linking Study Carrels	1-47
Adding Power to Study Carrels	1-48
Mailroom Furniture	1-49

THE tréo® SYSTEM

INLINE
tréo

OVERVIEW

INLINE tréo® offers:

- A very extensive range of components and sizes, including tops from 24" to 84" wide in various depths.
- A multitude of tall and low storage options and accessories.
- Flexibility in laminate selection and mixing of finishes, colors and edging.
- Superior structural strength using metal-to-metal (Mod-eez®) fasteners.

CONSTRUCTION DETAILS

General

- Tops, end panels and weight-bearing shelves are 1" thick with 3mm PVC edging.
- No charge option to have HPL tops made 1¹/₁₆" thick; subject to minimum volume requirements.
- Doors, drawer fronts and modesty panels are 3/4" thick.
- Doors and drawer fronts are edged on all sides with 3mm PVC edging.
- Non-PVC edging available for special applications; subject to minimum volume requirements.
- All core material is 45 lb commercial grade particle board.

Worksurfaces

- All worksurfaces are 28.5" high unless otherwise stated.
- Glides provide over 1" height adjustability (stem is 1¹/₂" long).
- All end panels, both full and partial, are non-handed.
- Modesty panels are 3/4" thick and are reversible.
- Full modesty panels are same height as end panel.
- Partial modesty panel is 16" off floor for normal power/data access.
- Wall access modesty panels provide 20" clear access which is the new building code standard for new construction.
- End panels are flush to ends of top and modesty is flush to back, unless otherwise noted.
- Width and depth dimensions for tops are actual.
- Worksurfaces come with one grommet unless otherwise stated.
- Islands (D, P, Q and K) not intended to be used as freestanding units.



Drawers

- All drawers, including box drawers, have full extension, tempered steel, ball-bearing slides.
- All drawers on pedestals and lateral files gang-lock.
- Box and file drawers have load capacity of 100 lbs.
- Lateral file drawers have load capacity of 150 lbs.
- All lateral file drawers have steel reinforced bottoms.
- Top box drawers include a pencil tray, except in multifiles, where the box drawers are slightly narrower.
- Drawer interiors are black textured, mar-resistant finish for easy cleaning
- Floor pedestals have 1" leveling capability.

Miscellaneous

- Modesty panels use structurally superior, hidden, Mod-eez® fasteners. Most other connections use conventional cam & pin fittings.
- All locking units are keyed randomly unless specified "keyed-alike" at time of order (no up-charge).
- All units, except those with drawers, are shipped RTA (ready to assemble).
- Translucent doors on tall storage units and hutches have anodized aluminium frames with mitred joints.

FINISHES

- One, two or three tone finishes available. Tops, faces and chassis can be same finish or mixed in any combination (see How to Specify Finishes in INLINE tréo® page 1-3).
- 16 standard Thermally Fused Laminates (TFL).
- 22 standard High Pressure Laminates (HPL) - available for worksurfaces, drawer faces and door fronts.
- INLINE thermally fused laminates meet all the performance requirements of high pressure laminate required for sales as worksurfaces under National Master Standing Offer and Supply Arrangement contracts.
- All solid and woodgrain TFL finishes come with matching edging as standard.
- All solid and woodgrain HPL finishes come with matching edging except for Ginger Root Maple.
- User has option to specify contrasting edging (eg. black edging on cherry laminate).

- Custom HP Laminates can be used for a nominal upcharge.
- Standard Finishes shown on page 8-2.



Standard Laminates

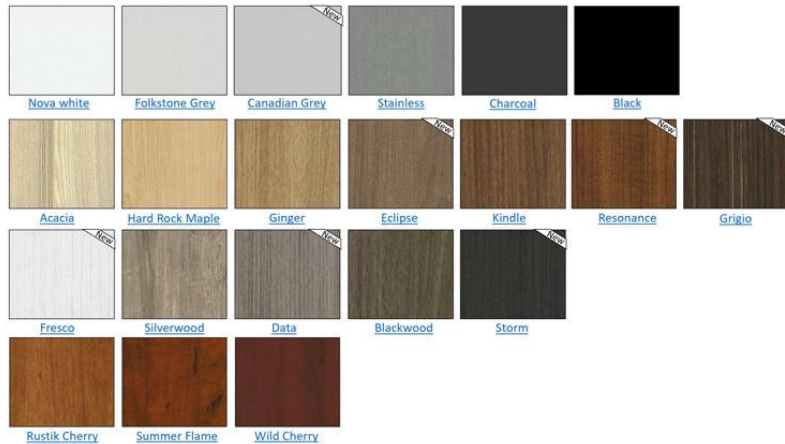

Handles



Inline and Qi are brands of fluidconcept & design inc. All rights, industrial designs and copyrights reserved.

HOW TO SPECIFY INLINE tréo® FINISHES

TOPS, RECTANGULAR, CURVED, CORNER, EXTENDED CORNER, BRIDGING

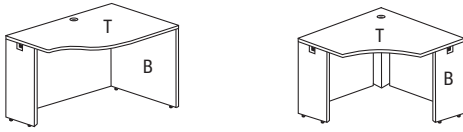

T = Top finish (worksurface), can be specified in either TFL or HPL
TT = Top Trim selection
B = Base finish (support and modesty panels), can be specified in TFL only
BT = Base Trim selection

TOPS – D, P, Q, K

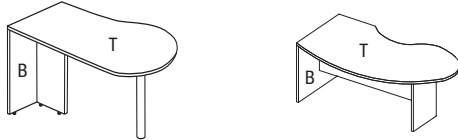

T = Top finish (worksurface), can be specified in either TFL or HPL
TT = Top Trim selection
B = Base finish (support and modesty panels), can be specified in TFL only
BT = Base Trim selection
 Post leg units come standard with black post leg
 Nickel post leg available, add "N" to end of product code and add \$105 List

DESKS – REGULAR, BOW, TOP, EXECUTIVE RETURNS

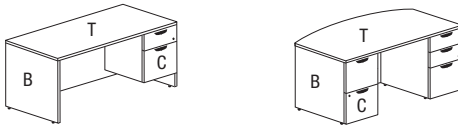

T = Top finish (worksurface), can be specified in either TFL or HPL
TT = Top Trim selection
C = Contrast finish (drawer fronts), can be specified in either TFL or HPL
CT = Contrast Trim selection
B = Base finish (support and modesty panels), can be specified in TFL only
BT = Base Trim selection
 (-) = Handle selection, choose from 4 styles of handle for pedestals

HUTCHES – OPEN, TRANSACTION, FLIPPER DOOR, CUPBOARD DOOR, TALL STORAGE UNITS

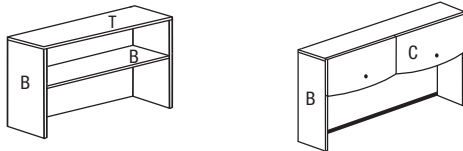

T = Top finish (top panel), can be specified in TFL only (except transaction hutches can be HPL, for flipper door hutches top matches base finish)
TT = Top Trim selection
C = Contrast finish (drawer/door fronts), can be specified in either TFL or HPL
CT = Contrast Trim selection
B = Base finish (support and back panels, shelves on open hutches), can be specified in TFL only
BT = Base Trim selection
 (-) = Handle selection, choose from 4 styles of handle for Tall Storage Units

PEDESTALS – MOBILE, FLOOR, HANGING



T = Top finish (mobiles), can be specified in either TFL or HPL (extra)
TT = Top Trim selection
C = Contrast finish (drawer/door fronts), can be specified in either TFL or HPL
CT = Contrast Trim selection
B = Base finish (pedestal body), can be specified in TFL only
BT = Base Trim selection
 (-) = Handle selection, choose from 4 styles of handle for pedestals

LOW STORAGE – LATERAL FILES, MULTIFILES, CREDENZAS

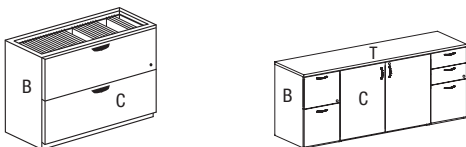

T = Top finish (freestanding only), can be specified in either TFL or HPL
TT = Top Trim selection
C = Contrast finish (drawer/door fronts), can be specified in either TFL or HPL
CT = Contrast Trim selection
B = Base finish (support and back panels), can be specified in TFL only,
BT = Base Trim selection
 (-) = Handle selection, choose from 4 styles of handle for doors and drawers

ACCESSORIES – BOOKCASES, KEYBOARDS, ETC.

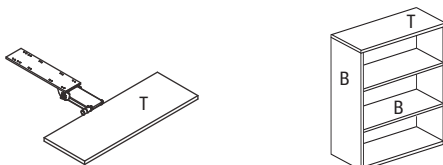

T = Top finish (keyboard tray), can be specified in either TFL or HPL,
TT = Top Trim selection
B = Bookcase shelves / gables
BT = Base Trim selection
Mechanisms such as keyboard trays come in Black only
Bookcases are available in TFL only, also need to specify your choice of edging

Treo

Typical Examples



TR-1
Desk & Credenza (72"x72")



TR-2
Desk with Post, BBF Lateral, Desk Tower and Shelf, modesty (72"x72")



TR-3
Desk, Credenza and Mounted Tower with Frosted screen and modesty (72"x72")



TR-4
4 Pack Bench with Credenza and center frosted screens (72"x72")



TR-5
4 Offset Workstation with Credenza, Cubby Upper Screens and Modesty (72"x72")



TR-6
Private Office Workstation—Desk, Return, Credenza and Mounted Tower (90"x72")



TR-7
2 Pack Bench with Credenza, tower and wall mounted overhangs (72"x72")



TR-8
L-Dual Workstation with center offset hutch, BBF (72"x72")



TR-9
L-4 Pack Workstation with center offset hutch, BBF and Mobile BF (72"x72")



TR-7
2 Pack Bench with Credenza, tower and wall mounted overhangs (72"x72")



TR-8
L-Dual Workstation with center offset hutch, BBF (72"x72")



TR-9
L-4 Pack Workstation with center offset hutch, BBF and Mobile BF (72"x72")



TR-7
2 Pack Bench with Credenza, tower and wall mounted overhangs (72"x72")



TR-8
L-Dual Workstation with center offset hutch, BBF (72"x72")



TR-9
L-4 Pack Workstation with center offset hutch, BBF and Mobile BF (72"x72")

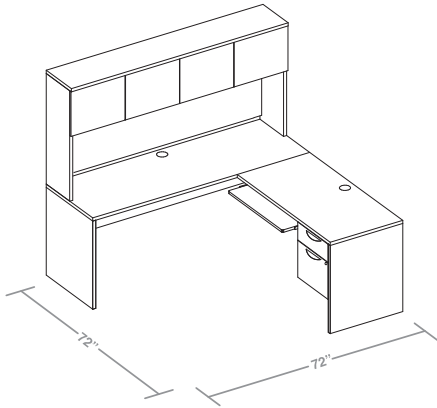

L-GROUP: SUITE #TR001

Item	Model
Rectangular Shell	3 TP 7224 - X
Executive Return	3 ER H 4824 R
Cupboard Door Hutch	3 HD 7236
Keyboard	3 KS 2611

Options: Door Locks, Tackboard, Task Light, Wire Management, CPU Trolley

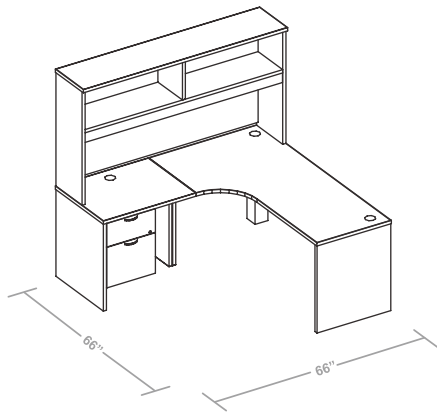

L-GROUP: SUITE #TR002

Item	Model
Extended Corner	3 CEP 3624 R66 - Y
Rectangular Shell	3 TP 3024 - Y
Hanging Ped	3 SHW 20
Open Hutch	3 HH T 6636

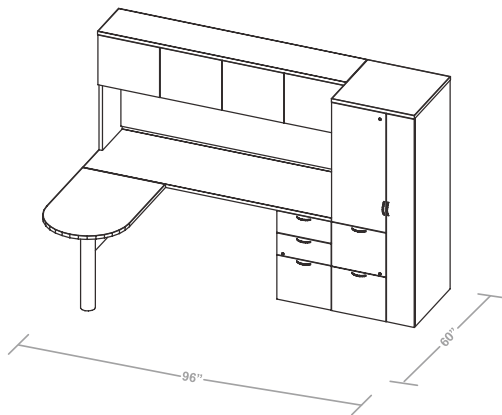

L-GROUP: SUITE #TR003

Item	Model
Credenza	3 SCP 7224 BXX
D-Island	3 DN 3624
Cupboard Door Hutch	3 HD 7236
Tall Multistorage	3 SIMD 2465 R

Hutch Lock Option: HDLK4

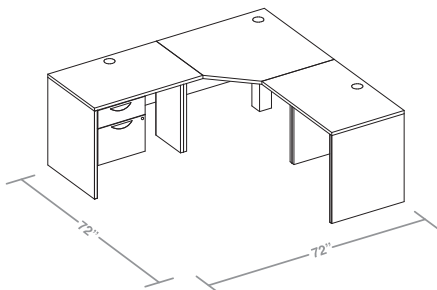

L-GROUP: SUITE #TR004

Item	Model
Corner Unit	3 CP 3624 S
Rectangular Shell	3 TP 3624 - Y
Rectangular Shell	3 TP 3624 - Y
Hanging Ped	3 SHW 20

All stations shown can be electrified. See Accessories Section 7 or contact customer service to discuss your needs.



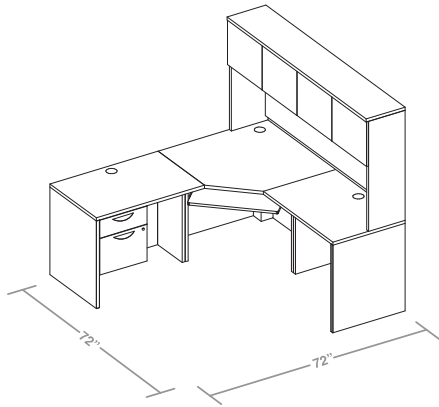

L-GROUP: SUITE #TR005

Item	Model
Corner Unit	3 CF 3624 S
Rectangular Shell	3 TF 3624 - Y
Rectangular Shell	3 TF 3624 - Y
Hanging Ped	3 SHW 20
Keyboard	3 KS 2611
Cupboard Door Hutch	3 HD 7236

Options: Door Locks, Tackboard, Task Light, Wire Management, CPU Trolley

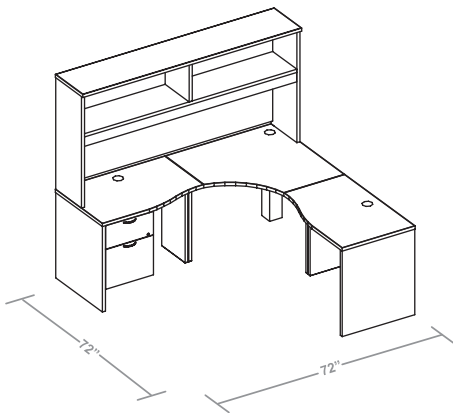

L-GROUP: SUITE #TR006

Item	Model
Corner Unit	3 CP 3620 C
Curved Shell	3 TP 3624 R20 C - Y
Curved Shell	3 TP 3624 L20 C - Y
Hanging Ped	3 SHW 20
Open Hutch	3 HH T 7236

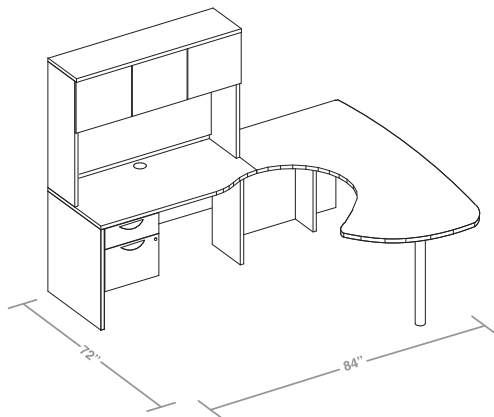

L-GROUP: SUITE #TR007

Item	Model
K-Island	3 PKTS 7236 R
Curved Shell	3 TP 4824 R20 C - Y
Hanging Ped	3 SHW 20
Open Hutch	3 HD 4836

Hutch Lock Option: HDLK3

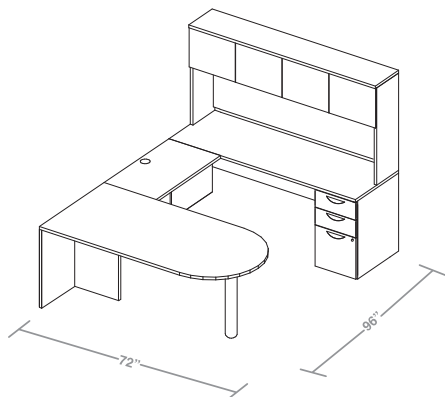

U-GROUP: SUITE #TR008

Item	Model
Credenza	3 SCP 7224 BXX
Linking Top	3 BN 3620 S
D-Island	3 DT 7236
Cupboard Door Hutch	3 HD 7236

Hutch Lock Option: HDLK4

All stations shown can be electrified. See Accessories Section 7 or contact customer service to discuss your needs.

NOTE: All prices above are TFL

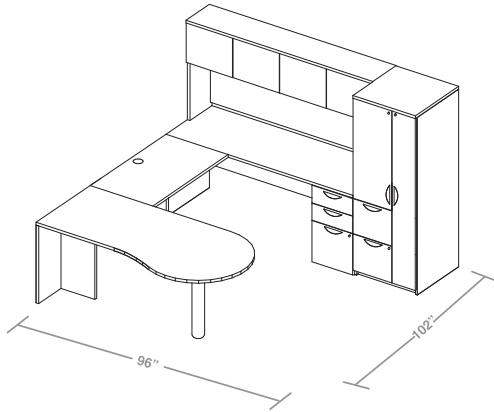

U-GROUP: SUITE #TR009

Item	Model
Credenza	3 SCP 7224 BXX
Linking Top	3 BN 4224 S
P-Island	3 PT 7230 R
Cupboard Door Hutch	3 HD 7236
Tall Multistorage	3 SIMD 2465 R

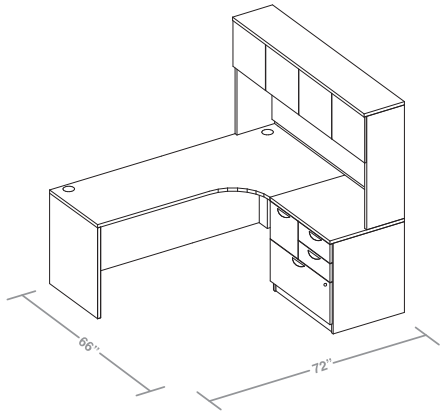

L-GROUP: SUITE #TR010

Item	Model
Extended Corner	3 CEF 3624 L72 - Y
Freestanding Multifile	3 SMF 3024
Cupboard Door Hutch	3 HD 6636

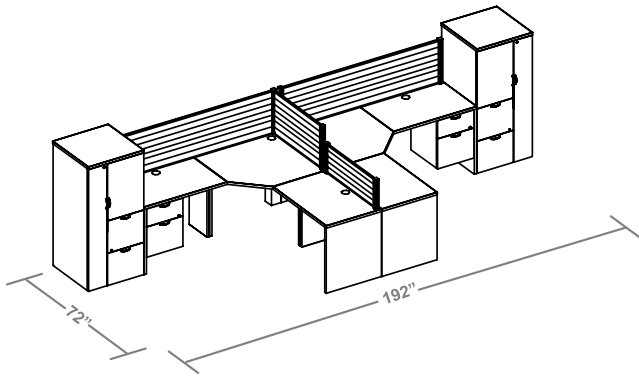

DUAL L-GROUP WITH SCREENS: SUITE #TR027

Item	Model
Corner Unit	3 CP 3624 S (x2)
Rectangular Shell	3 TP 3624-Y (x2)
Rectangular Shell	3 TF 3624-Y (x2)
Tall Storage (left)	3 SIMD 2454 L
Tall Storage (right)	3 SIMD 2454 R
Hanging Ped	3 SHW 20 (x2)
Screen Post	FSPST 12 (x2)
Screen Post	FSPST 18 (x5)
Smoked Acrylic Screen	FSPST 3612
Smoked Acrylic Screen	FSPST 3618
Smoked Acrylic Screen	FSPST 7218 (x2)
Fabric Gap Filler (12")	FGF 12 BL
Fabric Gap Filler (18")	FGF 18 BL

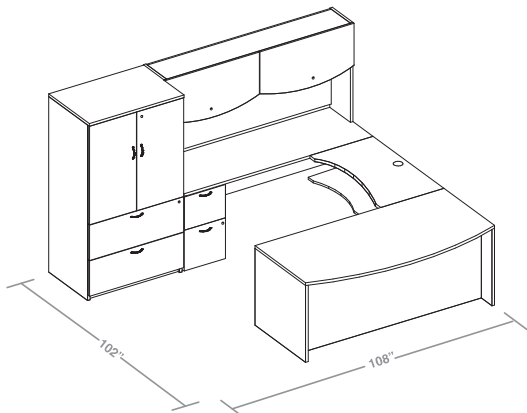

U-GROUP: SUITE #TR012

Item	Model
Credenza	3 SCP 7224 FXX
Bow Front Desk (B/B/F)	3 RFB 7236 XB
Bridging Top	3 BF 4224 C
Curved Flipper Door Hutch	3 HF C 7236
Tall Storage	3 SPF 362465
Keyboard	3 KS 3215

All stations shown can be electrified. See Accessories Section 7 or contact customer service to discuss your needs.

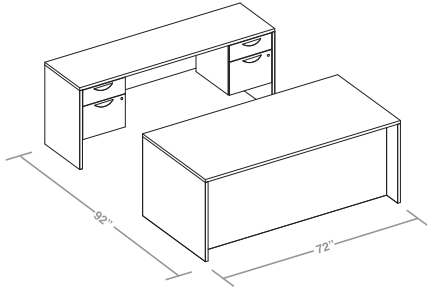

U-GROUP: SUITE #TR013

Item	Model
Credenza	3 SCP 7220 HXH
Desk (B/F; B/F)	3 RF 7236 HH

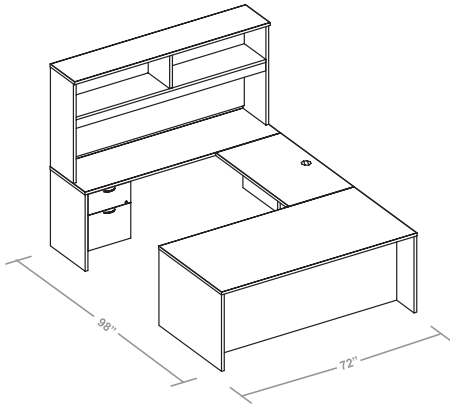

U-GROUP: SUITE #TR014

Item	Model
Credenza	3 SCP 7220 HXX
Desk (B/F)	3 RF 7236 HX
Linking Top	3 BN 4224 S
Open Hutch	3 HH T 7236

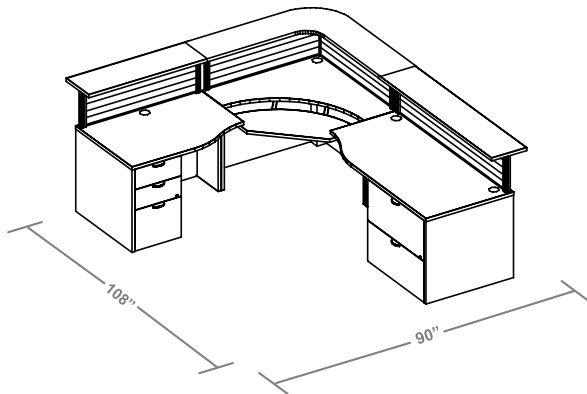

RECEPTION DESK WITH SCREENS: SUITE #TR025

Item	Model
Corner w/ KB	3 CFK 4224 S
Curved Shell	3 TF 4230 R24 C-Y
Curved Shell	3 TF 6030 L24 C-Y
Lateral File	3 SLU 3024
Floor Ped (B/B/F)	3 SJX 24
Screen Post	FSPST 12 (x7)
Smoked Acrylic Screen	FSPS 4212 (x3)
Smoked Acrylic Screen	FSPS 6012
Transaction Top (42")	3 FSC 4212 S
Transaction Top (60")	3 FSC 6012 S
Corner Trans. Top	3 FSCS 4242
Fabric Gap Filler (2)	FGF 12 BL

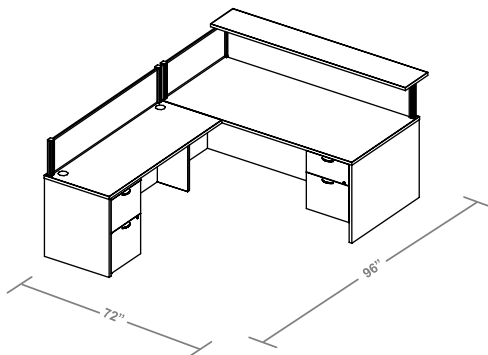

RECEPTION DESK WITH SCREENS: SUITE #TR026

Item	Model
Desk w / Hanging Ped	3 RF 7236 HX
Rectangular Shell	3 TF 6024-Y
Mobile Ped (F/F)	3 SMY 20
Screen Posts (12")	FSPST 12 (x5)
Fabric Screen (72")	FSPF 7212
Fabric Screen (36")	FSPF 3612
Fabric Screen (60")	FSPF 6012
Transaction Top	3 FSC 7212 S
Fabric Gap Filler	FGF 12 BL

N/C

All stations shown can be electrified. See Accessories Section 7 or contact customer service to discuss your needs.

NOTE: All prices above are TFL

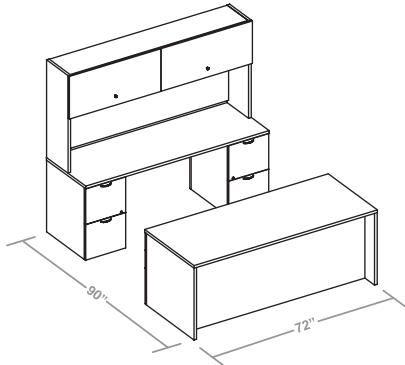

EXECUTIVE DESK: SUITE #TR017

Item	Model
Credenza	3 SCP 7224 FXF
Desk (F/F, B/B/F)	3 RF 7230 FB
Hutch	3 HF S 7236

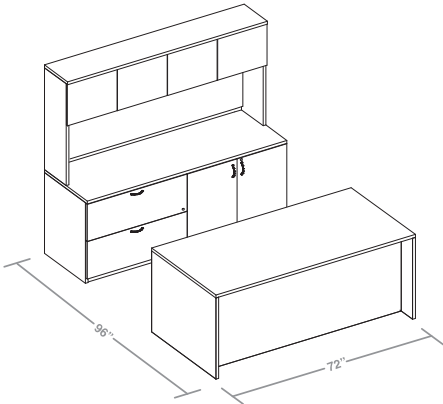

EXECUTIVE DESK: SUITE #TR018

Item	Model
Credenza	3 SCF 7224 LS
Desk (B/F; B/F)	3 RF 7236 HH
Cupboard Door Hutch	3 HD 7236

Hutch Lock Option: HDLK4

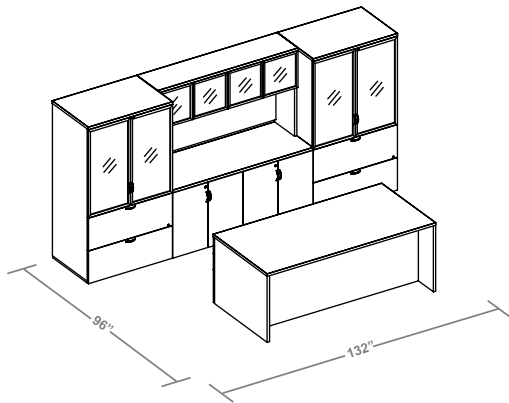

EXECUTIVE DESK: SUITE #TR028

Item	Model
Desk (F/F; B/B/F)	3 RF 7236 FB\
Credenza	3 SCF 6024 SS
Hutch	3 HD G 6036\
Tall Storage	3 SPFG 362465 (x2)

Hutch Lock Option: HDLK4

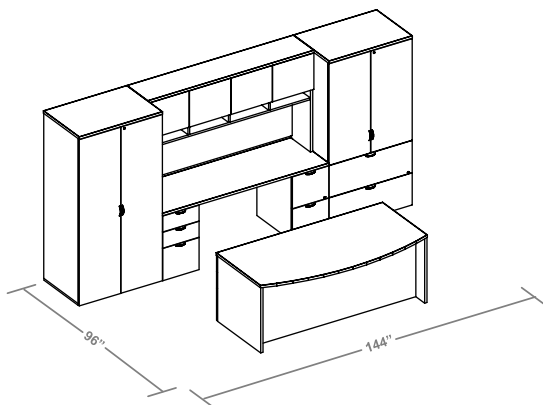

EXECUTIVE DESK: SUITE #TR029

Item	Model
Desk (F/F; B/B/F)	3 RFB 7236 FB
Credenza	3 SCP 7224 FXB
Cupboard Door Hutch	3 HD 7243
Tall Storage (left)	3 SPB 362472
Tall Storage (right)	3 SPF 362472
Paper Management	3 SHP 70

Options: Door Locks, Tackboard, Task Light, Wire Management, CPU Trolley

All stations shown can be electrified. See Accessories Section 7 or contact customer service to discuss your needs.





NOTES

A large grid area for taking notes, consisting of many small squares. The grid is composed of 20 columns and 30 rows of small squares, providing a structured space for writing or drawing.

REGULAR & BOW TOP DESKS

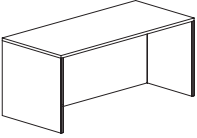
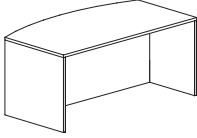
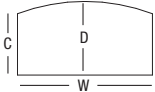
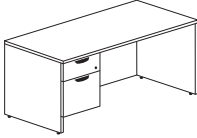
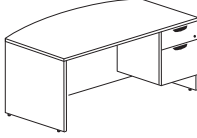
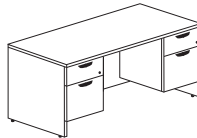
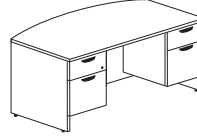
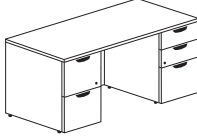

tréo®

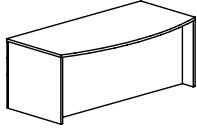
DESK SHELLS		Model #	W	D	C	Wt	V	TFL \$	HPL \$	Remarks		
   SIN 711-2	Regular Desk Shell	3 RF 4824	48	24	24	88	5.8			<ul style="list-style-type: none"> Using Desk Shells and Mobile or Floor Peds provides non-handed configurations <p>Regular Shells</p> <ul style="list-style-type: none"> Full height modesty recessed 6" on 30"D and 10" on 36"D <p>Bow Top Shells</p> <ul style="list-style-type: none"> Full height modesty recessed at end panels, 6" on 36"D and 10" on 42"D 		
		3 RF 4830	48	30	30	96	5.8					
		3 RF 6030	60	30	30	118	4.5					
		3 RF 6630	66	30	30	126	4.8					
		3 RF 7230	72	30	30	133	5.0					
		3 RF 6036	60	36	36	134	4.9					
		3 RF 6636	66	36	36	144	5.2					
		3 RF 7236	72	36	36	153	5.6					
		3 RF 8436	84	36	36	170	6.2					
		Bow Top Desk Shell	3 RFB 6636	66	36	30	136	5.0				
		3 RFB 7236	72	36	30	145	5.4					
		3 RFB 7242	72	42	36	164	6.2					
		3 RFB 8442	84	42	36	183	7.0					
SINGLE PEDESTAL DESKS – HANGING PED												
  SIN 711-2	Single Pedestal Desk (Non-Handed)	3 RF 4824 HX (-)	48	24	24	150	9.8			<p>Single Pedestal Desk – Hanging Ped</p> <ul style="list-style-type: none"> 1 locking B/F Hanging Pedestal on left or right Pencil tray in box drawer Full height modesty recessed 6" on 30"D and 10" on 36"D <p>Single Pedestal Bow Top Desk – Hanging Ped</p> <ul style="list-style-type: none"> 1 locking B/F Hanging Pedestal on left or right Pencil tray in box drawer Bow Top worksurface Full height modesty recessed at end panels, 6" on 36"D and 10" on 42"D <p>Non-Handed Desks</p> <ul style="list-style-type: none"> Single hanging pedestal desks are non-handed, allowing ped to be installed left or right on these units <p>Double Pedestal Desk – Hanging Peds</p> <ul style="list-style-type: none"> 2 locking B/F Hanging Pedestals Pencil tray Full height modesty recessed 6" on 30"D and 10" on 36"D <p>Double Pedestal Bow Top Desk – Hanging Peds</p> <ul style="list-style-type: none"> 2 locking B/F Hanging Pedestals Pencil tray Bow Top worksurface Full height modesty recessed at end panels, 6" on 36"D and 10" on 42"D <p>Double Pedestal Desk – Floor Peds</p> <ul style="list-style-type: none"> 1 locking B/B/F Pedestal on right 1 locking F/F Pedestal on left Pencil tray Full height modesty recessed 6" on 30"D and 10" on 36"D <p>Double Pedestal Bow Top Desk – Floor Peds</p> <ul style="list-style-type: none"> 1 locking B/B/F Pedestal on right 1 locking F/F Pedestal on left Pencil tray Bow Top worksurface Full height modesty recessed at end panels, 6" on 36"D and 10" on 42"D <div style="border: 1px solid black; padding: 5px; margin-top: 10px;"> Can specify up to 3 finishes (Contrast – drawer faces, Base-body, Top-top) – drawer faces or top or both can be HP laminate </div>		
		3 RF 4830 HX (-)	48	30	30	165	9.8					
		3 RF 6030 HX (-)	60	30	30	180	8.5					
		3 RF 6630 HX (-)	66	30	30	188	8.8					
		3 RF 7230 HX (-)	72	30	30	196	9.0					
		3 RF 7236 HX (-)	72	36	36	208	9.6					
		Single Pedestal Bow Top Desk (Non-Handed)	3 RFB 7236 HX (-)	72	36	30	208	9.4				
			3 RFB 7242 HX (-)	72	42	36	221	10.2				
	DOUBLE PEDESTAL DESKS – HANGING PED											
	  SIN 711-2	Double Pedestal Desk	3 RF 6030 HH (-)	60	30	30	240	12.5				
		3 RF 6630 HH (-)	66	30	30	248	12.7					
		3 RF 7230 HH (-)	72	30	30	256	13.1					
		3 RF 7236 HH (-)	72	36	36	268	13.6					
		Double Pedestal Bow Top Desk	3 RFB 7236 HH (-)	72	36	30	268	13.4				
			3 RFB 7242 HH (-)	72	42	36	281	14.2				
DOUBLE PEDESTAL DESKS – FLOOR PED												
   SIN 711-2		Double Pedestal Desk	3 RF 6030 FB (-)	60	30	30	272	16.8				
			3 RF 6630 FB (-)	66	30	30	280	17.6				
			3 RF 7230 FB (-)	72	30	30	288	18.0				
		3 RF 7236 FB (-)	72	36	36	300	19.0					
		Double Pedestal Desk with Bow Top	3 RFB 7236 FB (-)	72	36	30	300	19.0				
			3 RFB 7242 FB (-)	72	42	36	313	20.0				
	↑ Enter Handle Selection to complete code											

LEGEND: W=width; D=mid-depth; C=side-depth (inches); Wt=shipping weight (lbs); V=volume (cubic feet); TFL \$=thermally fused laminate \$; HPL \$= high pressure laminate \$

REGULAR & BOW TOP DESKS



SINGLE PEDESTAL DESKS – FLOOR PED		Model #	W	D	C	Wt	V	TFL \$	HPL \$	Remarks
	Regular Desk	3 RF 6030 BX (-)	60	30	30	202	11.8			<ul style="list-style-type: none"> All desks on this page are handed. Peds cannot be switched. <p>Left Single Pedestal Desk</p> <ul style="list-style-type: none"> 1 locking B/B/F Pedestal on left Pencil tray Full height modesty recessed 6" on 30"D and 10" on 36"D <p>Left Single Pedestal Bow Top Desk</p> <ul style="list-style-type: none"> 1 locking B/B/F Pedestal on left Pencil tray Bow Top worksurface Full height modesty recessed at end panels, 6" on 36"D and 10" on 42"D <p>Right Single Pedestal Desks</p> <ul style="list-style-type: none"> 1 locking B/B/F Pedestal on right Pencil tray Full height modesty recessed 6" on 30"D and 10" on 36"D <p>Right Single Pedestal Bow Top Desk</p> <ul style="list-style-type: none"> 1 locking B/B/F Pedestal on right Pencil tray Bow Top worksurface Full height modesty recessed at end panels, 6" on 36"D and 10" on 42"D
	Left Pedestal (Handed)	3 RF 6630 BX (-)	66	30	30	210	12.6			
		3 RF 7230 BX (-)	72	30	30	218	13.0			
		3 RF 7236 BX (-)	72	36	36	230	14.0			
		3 RF 8436 BX (-)	84	36	36	245	14.6			
	Bow Top Desk	3 RFB 7236 BX (-)	72	36	30	230	14.0			
	Left Pedestal (Handed)	3 RFB 7242 BX (-)	72	42	36	243	15.0			
	Regular Desk	3 RF 6030 XB (-)	60	30	30	202	11.8			
	Right Pedestal (Handed)	3 RF 6630 XB (-)	66	30	30	210	12.6			
		3 RF 7230 XB (-)	72	30	30	218	13.0			
		3 RF 7236 XB (-)	72	36	36	230	14.0			
	Bow Top Desk	3 RFB 7236 XB (-)	72	36	30	230	14.0			
	Right Pedestal (Handed)	3 RFB 7242 XB (-)	72	42	36	243	15.0			

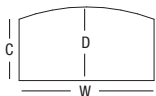

SIN 711-2

EXTENDED CORNER DESKS – FLOOR PED		Model #	A	B	C	D	Wt	V	TFL \$	HPL \$	Remarks	
	Left Pedestal (Handed)	3 RFBC 7248 BX (-)	72	48	24	30	243	15.0			<p>GC6000 (3") grommets available in standard worksurface locations for all Regular and Bow Top Desks. Add \$35 List per Grommet</p> <p>Order as:</p> <p>GL (Grommet Left)</p> <ul style="list-style-type: none"> Grommet positioned with center 4" in from left edge of worksurface, straddling modesty panel <p>GC (Grommet Center)</p> <ul style="list-style-type: none"> Grommet centered width wise on worksurface, straddling modesty panel <p>GR (Grommet Right)</p> <ul style="list-style-type: none"> Grommet positioned with center 4" in from right edge of worksurface, straddling modesty panel 	
	Right Pedestal (Handed)	3 RFBC 7248 XB (-)	72	48	24	30	243	15.0				
		<p>↑</p> <p>Enter Handle Selection to complete code</p>										
		<p>Can specify up to 3 finishes (Contrast – drawer faces, Base-body, Top-top) – drawer faces or top or both can be HP laminate</p>										

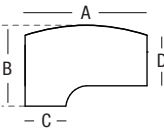

SIN 711-2

LEGEND: W=width; D=mid-depth; C=side-depth (inches); Wt=shipping weight (lbs); V=volume (cubic feet); TFL \$=thermally fused laminate \$; HPL \$= high pressure laminate \$

OPEN & EXECUTIVE RETURNS





tree®

OPEN RETURNS		Model #	W	D	Wt	V	TFL \$	HPL \$	Remarks	
<p>SIN 711-2</p>	Left – 20" Deep	3 ER N 3620 L	36	20	58	2.0			<ul style="list-style-type: none"> Includes top, full height modesty panel, end panel and hardware Modesty panel is 1" thick plus has glide at both ends Connects to desk with flat brackets Cross-grain on top to match abutting desk. Returns are handed and cannot be switched. 	
		3 ER N 4220 L	42	20	65	2.3				
		3 ER N 4820 L	48	20	72	2.5				
	Left – 24" Deep	3 ER N 3624 L	36	24	65	2.0				
		3 ER N 4224 L	42	24	73	2.3				
		3 ER N 4824 L	48	24	80	2.5				
	Right – 20" Deep	3 ER N 3620 R	36	20	58	2.0				
		3 ER N 4220 R	42	20	65	2.3				
		3 ER N 4820 R	48	20	72	2.5				
	Right – 24" Deep	3 ER N 3624 R	36	24	65	2.0				
		3 ER N 4224 R	42	24	73	2.3				
		3 ER N 4824 R	48	24	80	2.5				
EXECUTIVE RETURNS – LEFT										
<p>SIN 711-2</p>	BOX / FILE PEDESTAL 20" Deep	3 ER H 3020 L (-)	30	20	104	5.9			<ul style="list-style-type: none"> Includes top, full height modesty panel, end panel and hardware Can specify up to 3 finishes (Contrast – drawer faces, Base - body, Top - top) – drawer faces or top or both can be HP Laminate Need to select handle style and finish Gang lock secures all pedestal drawers Drawers mounted on full extension, ball bearing slides Includes suspension bars Accepts legal & letter files Box / File and Box / Box / File peds include one pencil tray Modesty panel is 1" thick plus has glide at both ends Connects to desk with flat brackets Cross-grain on top to match abutting desk. Returns are handed and cannot be switched. 	
		3 ER H 3620 L (-)	36	20	111	6.1				
		3 ER H 4220 L (-)	42	20	118	6.3				
		3 ER H 4820 L (-)	48	20	125	6.5				
	24" Deep	3 ER H 4224 L (-)	42	24	124	6.3				
		3 ER H 4824 L (-)	48	24	131	6.5				
	BOX / BOX / FILE 20" Deep	3 ER B 4220 L (-)	42	20	136	8.3				
		3 ER B 4820 L (-)	48	20	143	8.5				
		24" Deep	3 ER B 4224 L (-)	42	24	141	8.3			
			3 ER B 4824 L (-)	48	24	148	8.5			
	FILE / FILE PEDESTAL 20" Deep	3 ER F 4220 L (-)	42	20	136	8.3				
		3 ER F 4820 L (-)	48	20	143	8.5				
24" Deep		3 ER F 4224 L (-)	42	24	141	8.3				
		3 ER F 4824 L (-)	48	24	148	8.5				
		↑		Enter Handle Selection to complete code						
EXECUTIVE RETURNS – RIGHT										
<p>SIN 711-2</p>	BOX / FILE PEDESTAL 20" Deep	3 ER H 3020 R (-)	30	20	104	5.9			<ul style="list-style-type: none"> Connects to desk with flat brackets Cross-grain on top to match abutting desk. Returns are handed and cannot be switched. 	
		3 ER H 3620 R (-)	36	20	111	6.1				
		3 ER H 4220 R (-)	42	20	118	6.3				
		3 ER H 4820 R (-)	48	20	125	6.5				
	24" Deep	3 ER H 4224 R (-)	42	24	124	6.3				
		3 ER H 4824 R (-)	48	24	131	6.5				
	BOX / BOX / FILE 20" Deep	3 ER B 4220 R (-)	42	20	136	8.3				
		3 ER B 4820 R (-)	48	20	143	8.5				
		24" Deep	3 ER B 4224 R (-)	42	24	141	8.3			
			3 ER B 4824 R (-)	48	24	148	8.5			
	FILE / FILE PEDESTAL 20" Deep	3 ER F 4220 R (-)	42	20	136	8.3				
		3 ER F 4820 R (-)	48	20	143	8.5				
24" Deep		3 ER F 4224 R (-)	42	24	141	8.3				
		3 ER F 4824 R (-)	48	24	148	8.5				
		↑		Enter Handle Selection to complete code						
						4 Handles to choose from: K1 Black, Tear Drop K2 Black, Wire N1 Nickel, Tear Drop N2 Nickel, Wire				

LEGEND: W=width; D=depth; H=height (inches); Wt=shipping weight (lbs); V=volume (cubic feet); TFL \$=thermally fused laminate \$; HPL \$= high pressure laminate \$

BRIDGING & LINKING TOPS

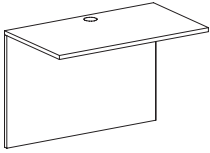
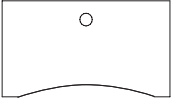
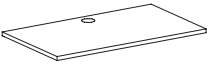
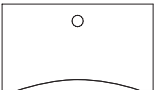
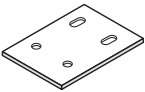

BRIDGING TOPS (WITH MODESTY)		Model #	W	D	Wt	V	TFL \$	HPL \$	Remarks
 Straight SIN 711-2	20" Deep	3 BF 3020 S	30	20	35	2.5			<ul style="list-style-type: none"> Cross-grain on top to match abutting desk Bridging Tops <ul style="list-style-type: none"> Includes top, full height modesty panel and hardware Modesty panels are 1" thick, flush to back Includes 4 flat brackets and 2 glides One grommet – centered Choosing a Pedestal <ul style="list-style-type: none"> 24"D BF's will accommodate 20"D floor or mobile pedestals only 20"D BF's do not accommodate pedestals. Use 20"D BN model Curved BF's do not accommodate pedestals
		3 BF 3620 S	36	20	44	2.5			
	3 BF 4220 S	42	20	56	3.0				
	3 BF 4820 S	48	20	67	3.0				
24" Deep	3 BF 3024 S	30	24	42	2.0				
	3 BF 3624 S	36	24	53	2.3				
	3 BF 4224 S	42	24	64	2.6				
	3 BF 4824 S	48	24	72	3.0				
 Curved SIN 711-2	24" Deep Curved	3 BF 3024 C	30	24	42	2.0			
		3 BF 3624 C	36	24	53	2.3			
		3 BF 4224 C	42	24	64	2.6			
		3 BF 4824 C	48	24	72	3.0			
LINKING TOPS (NO MODESTY)									
 Straight SIN 711-2	20" Deep	3 BN 3020 S	30	20	16	1.3			<ul style="list-style-type: none"> Cross-grain on top to match abutting desk Linking Tops <ul style="list-style-type: none"> Includes top and 4 flat brackets One grommet – centered Choosing a Pedestal <ul style="list-style-type: none"> 20"D pedestals go with 20"D BN's 24"D pedestals go with 24"D straight BN's Curved BN's do not accommodate pedestals
		3 BN 3620 S	36	20	19	1.6			
	3 BN 4220 S	42	20	22	1.8				
	3 BN 4820 S	48	20	25	2.0				
	3 BN 6020 S	60	20	31	2.5				
	3 BN 7220 S	72	20	38	3.0				
24" Deep	3 BN 3024 S	30	24	19	1.5				
	3 BN 3624 S	36	24	23	1.8				
	3 BN 4224 S	42	24	26	2.1				
	3 BN 4824 S	48	24	30	2.4				
	3 BN 6024 S	60	24	38	3.0				
	3 BN 7224 S	72	24	45	3.5				
 Curved SIN 711-2	24" Deep Curved	3 BN 3024 C	30	24	22	2.5			
		3 BN 3624 C	36	24	25	2.5			
		3 BN 4224 C	42	24	30	3.0			
		3 BN 4824 C	48	24	32	3.0			
FLAT BRACKET (PAIR)									
 SIN 711-2		3 BRPK2	2	3					<ul style="list-style-type: none"> Extra brackets sold in pairs
COMMON TOPS FOR FILES									
	20" Deep	3 BN 3020	30	20	18	2.5			<ul style="list-style-type: none"> Grain runs full width Special tops can be ordered to span files which are back to back Can be used to convert underdesk files to freestanding files Adding tops to single or double lateral files may require slightly different sizes, depending on age of file Measure exactly before ordering. <ul style="list-style-type: none"> Call factory for quote on custom sizes
		3 BN 3620	36	20	22	2.5			
		3 BN 4820	48	20	26	3.0			
		3 BN 6020	60	20	40	4.0			
		3 BN 6620	66	20	58	4.8			
		3 BN 7220	72	20	65	5.0			
		3 BN 7820	78	20	72	5.5			
	3 BN 8420	84	20	78	6.0				
	24" Deep	3 BN 3024	30	24	28	2.5			
		3 BN 3624	36	24	32	2.5			
		3 BN 4824	48	24	36	3.0			
		3 BN 5424	54	24	43	3.5			
		3 BN 6024	60	24	50	4.0			
		3 BN 6624	66	24	65	4.7			
3 BN 7224		72	24	75	5.0				
3 BN 7824	78	24	82	5.5					
	3 BN 8424	84	24	88	6.0				

LEGEND: W=width; D=depth (inches); Wt=shipping weight (lbs); V=volume (cubic feet); TFL \$=thermally fused laminate \$; HPL \$= high pressure laminate \$

CREDENZAS – FULL MODESTY



tree®

CREDENZAS		Model #	W	D	Wt	V	TFL \$	HPL \$ TOP ONLY	HPL \$ TOP & FRONT	Remarks	
<p>SIN 711-2</p>	2 Laterals 	3 SCF 6020 LL (-) 3 SCF 7220 LL (-) 3 SCF 6024 LL (-) 3 SCF 7224 LL (-)	60	20	255	23.1				Credenzas <ul style="list-style-type: none"> All lateral files and peds gang-lock and have full suspension drawers Cabinets are non-handed Cabinets can be installed facing opposite directions at user's option <ul style="list-style-type: none"> Files accept legal side-to-side as standard For either letter side-to-side or front-to-back configurations, see notes and accessories on page 1-29 	
	Lateral, Storage, 	3 SCF 6020 LS (-) 3 SCF 7220 LS (-) 3 SCF 6024 LS (-) 3 SCF 7224 LS (-)	60	20	235	23.1					
	2 Storage 	3 SCF 6020 SS (-) 3 SCF 7220 SS (-) 3 SCF 6024 SS (-) 3 SCF 7224 SS (-)	60	20	215	23.1					
	Combination 	3 SCF 6020 FSB (-) 3 SCF 6620 FSB (-) 3 SCF 7220 FSB (-)	60	20	257	22.0					
		3 SCF 6024 FSB (-) 3 SCF 6624 FSB (-) 3 SCF 7224 FSB (-)	60	24	277	26.3					
		3 SCF 6624 FSB (-) 3 SCF 7224 FSB (-)	66	24	277	26.5					
		3 SCF 7224 FSB (-)	72	24	295	28.3					
	<p>SIN 711-2</p>	Knee Space Lateral 	3 SCF 7220 LX (-) 3 SCF 8420 LX (-)	72	20	179	14.2				Knee Space Lateral Credenzas <ul style="list-style-type: none"> Lateral file can mount left or right Lateral files are 30" wide
		3 SCF 7224 LX (-) 3 SCF 8424 LX (-)	72	24	202	15.9					
	<p>SIN 711-2</p>	Knee Space Multifile 	3 SCF 7220 MX (-) 3 SCF 8420 MX (-)	72	20	179	14.2				Knee Space Multifile Credenzas <ul style="list-style-type: none"> Multifiles can mount left or right Multifiles are 30" wide Lateral and box drawers gang-lock Lock kit available for file drawer; order MFLK \$58 List (installed)
		3 SCF 7224 MX (-) 3 SCF 8424 MX (-)	72	24	202	15.9					
	<p>SIN 711-2</p>	Knee Space Storage 	3 SCF 7220 SX (-) 3 SCF 8420 SX (-)	72	20	171	14.2				Knee Space Storage Credenzas <ul style="list-style-type: none"> Storage unit can mount left or right Storage units are 30" wide Unit has one adjustable shelf behind doors
		3 SCF 7224 SX (-) 3 SCF 8424 SX (-)	72	24	194	15.9					
	<p>SIN 711-2</p>	Knee Space (Double Floor Pedestals) 	3 SCF 7220 FXB (-) 3 SCF 6024 FXB (-) 3 SCF 6624 FXB (-) 3 SCF 7224 FXB (-)	72	20	220	13.9				Knee Space Floor Pedestal Credenzas <ul style="list-style-type: none"> Units are non-handed Peds can install left or right For 2 F/F peds, change suffix to FXF (see pg 1-15)
			3 SCF 6024 FXB (-) 3 SCF 6624 FXB (-) 3 SCF 7224 FXB (-)	60	24	231	13.3				
<p>SIN 711-2</p>	Knee Space B/B/F 	3 SCF 7220 BXX (-) 3 SCF 6024 BXX (-) 3 SCF 6624 BXX (-) 3 SCF 7224 BXX (-)	72	20	163	8.9			<ul style="list-style-type: none"> Peds can install left or right Box drawer models have one pencil tray <div style="border: 1px solid black; padding: 5px;"> <ul style="list-style-type: none"> For all Credenzas, can specify up to 3 finishes (Contrast – doors and drawers, Base – body, Top – top). Doors/drawers, top or both can be HPL, price depends on HPL option chosen. </div> <ul style="list-style-type: none"> Grommets available—see pg 7-5 Must be custom installed 		
		3 SCF 6024 BXX (-) 3 SCF 6624 BXX (-) 3 SCF 7224 BXX (-)	60	24	167	8.3					
<p>SIN 711-2</p>	Knee Space F/F 	3 SCF 7220 FXX (-) 3 SCF 6024 FXX (-) 3 SCF 6624 FXX (-) 3 SCF 7224 FXX (-)	72	20	163	8.9					
		3 SCF 6024 FXX (-) 3 SCF 6624 FXX (-) 3 SCF 7224 FXX (-)	60	24	167	8.3					
<p>SIN 711-2</p>	Knee Space B/F 	3 SCF 6020 HXX (-) 3 SCF 7220 HXX (-)	60	20	155	7.3			Knee Space Hanging Pedestal Credenzas <ul style="list-style-type: none"> Units are non-handed Peds can install left or right <div style="border: 1px solid black; padding: 5px;"> <p>4 Handles to choose from:</p> <p>K1 Black, Tear Drop K2 Black, Wire N1 Nickel, Tear Drop N2 Nickel, Wire</p> <p>Enter Handle Selection in (-) to complete code</p> </div>		
		3 SCF 6024 HXX (-) 3 SCF 7224 HXX (-)	60	24	167	7.3					
<p>SIN 711-2</p>	Knee Space B/Fx2 	3 SCF 6020 HXH (-) 3 SCF 7220 HXH (-)	60	20	222	11.3					
		3 SCF 6024 HXH (-) 3 SCF 7224 HXH (-)	60	24	234	11.9					

LEGEND: W=width; D=depth; H=height (inches); Wt=shipping weight (lbs); V=volume (cubic feet); TFL \$=thermally fused laminate \$; HPL \$= high pressure laminate \$

CREDENZAS – PARTIAL MODESTY

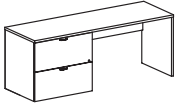
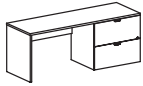
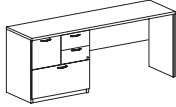
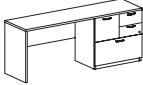
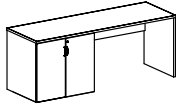
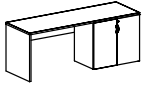
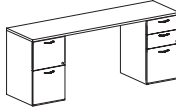
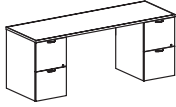
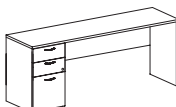
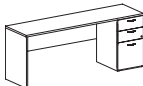
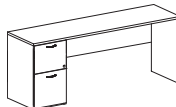
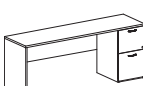
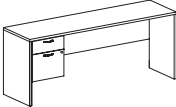
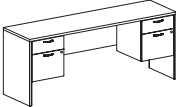
CREDENZAS		Model #	W	D	Wt	V	TFL \$	HPL \$ TOP ONLY	HPL \$ TOP & FRONT	Remarks
 SIN 711-2	Knee Space Lateral 	3 SCP 6620 LX (-)	66	20	165	13.1			Knee Space Lateral Credenzas <ul style="list-style-type: none"> All files/peds shipped assembled Lateral file can mount left or right Lateral files are 30" wide Legal files side-to-side, standard See pg. 1-29 for other options 	
		3 SCP 7220 LX (-)	72	20	169	13.3				
		3 SCP 8420 LX (-)	84	20	178	13.8				
		3 SCP 6624 LX (-)	66	24	177	15.2				
		3 SCP 7224 LX (-)	72	24	182	15.5				
3 SCP 8424 LX (-)	84	24	192	16.1						
 SIN 711-2	Knee Space Multifile 	3 SCP 6620 MX (-)	66	20	165	13.1			Knee Space Multifile Credenzas <ul style="list-style-type: none"> Multifiles can mount left or right Multifiles are 30" wide Lateral and box drawers gang-lock Lock kit available for file drawer; order MFLK \$58 List (installed) 	
		3 SCP 7220 MX (-)	72	20	169	13.3				
		3 SCP 8420 MX (-)	84	20	178	13.8				
		3 SCP 6624 MX (-)	66	24	177	15.2				
		3 SCP 7224 MX (-)	72	24	182	15.5				
3 SCP 8424 MX (-)	84	24	192	16.1						
 SIN 711-2	Knee Space Storage 	3 SCP 7220 SX (-)	72	20	161	13.3			Knee Space Storage Credenzas <ul style="list-style-type: none"> Storage unit can mount left or right Storage units are 30" wide Unit has one adjustable shelf behind doors 	
		3 SCP 8420 SX (-)	84	20	170	13.8				
		3 SCP 7224 SX (-)	72	24	174	15.5				
3 SCP 8424 SX (-)	84	24	184	16.1						
 SIN 711-2	Knee Space (Double Floor Pedestals)	3 SCP 7220 FXB (-)	72	20	210	13.0			Knee Space Floor Pedestal Credenzas <ul style="list-style-type: none"> Units are non-handed Peds can install left or right No modesty on SCP double ped credenzas 	
		3 SCP 6624 FXB (-)	66	24	220	13.2				
		3 SCP 7224 FXB (-)	72	24	225	13.5				
 SIN 711-2	Knee Space (Double Floor Pedestals)	3 SCP 7220 FXF (-)	72	20	210	13.0			<ul style="list-style-type: none"> For all Credenzas, can specify up to 3 finishes (Contrast – doors and drawers, Base - body, Top - top). Doors/drawers, top or both can be HPL, price depends on HPL option chosen. 	
		3 SCP 6624 FXF (-)	66	24	220	13.2				
		3 SCP 7224 FXF (-)	72	24	225	13.5				
 SIN 711-2	Knee Space B/B/F 	3 SCP 6020 BXX (-)	60	20	139	7.5			<ul style="list-style-type: none"> Peds can install left or right Box drawer models have one pencil tray 	
		3 SCP 6620 BXX (-)	66	20	143	7.8				
		3 SCP 7220 BXX (-)	72	20	148	8.0				
		3 SCP 6624 BXX (-)	66	24	156	8.2				
		3 SCP 7224 BXX (-)	72	24	161	8.5				
 SIN 711-2	Knee Space F/F 	3 SCP 6020 FXX (-)	60	20	151	8.3			<ul style="list-style-type: none"> For 20"H Wall Access Modesty panel, change code of any model on this page to 3 SCPQ and use Full Modesty version price (see page 1-14) 	
		3 SCP 6620 FXX (-)	66	20	157	8.6				
		3 SCP 7220 FXX (-)	72	20	163	8.9				
		3 SCP 6624 FXX (-)	66	24	174	8.6				
		3 SCP 7224 FXX (-)	72	24	181	8.9				
 SIN 711-2	Knee Space B/F	3 SCP 6020 HXX (-)	60	20	139	6.5			Knee Space Hanging Pedestal Credenzas <ul style="list-style-type: none"> Units are non-handed Peds can install left or right Box drawer models have one pencil tray 	
		3 SCP 7220 HXX (-)	72	20	148	7.0				
		3 SCP 6024 HXX (-)	60	24	151	7.0				
		3 SCP 7224 HXX (-)	72	24	161	7.5				
 SIN 711-2	Knee Space B/Fx2	3 SCP 6020 HXH (-)	60	20	206	10.5			<ul style="list-style-type: none"> Grommets available – see pg 7-5 Must be custom installed 	
		3 SCP 7220 HXH (-)	72	20	215	11.0				
		3 SCP 6024 HXH (-)	60	24	218	11.0				
		3 SCP 7224 HXH (-)	72	24	228	11.5				

Enter Handle Selection to complete code
4 Handles to choose from:
 K1 Black, Tear Drop
 K2 Black, Wire
 N1 Nickel, Tear Drop
 N2 Nickel, Wire

LEGEND: W=width; D=depth; H=height (inches); Wt=shipping weight (lbs); V=volume (cubic feet); TFL \$=thermally fused laminate \$; HPL \$= high pressure laminate \$

"D" ISLANDS

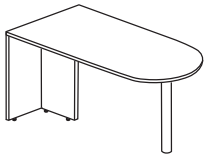
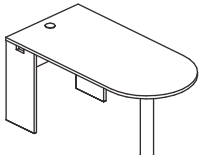
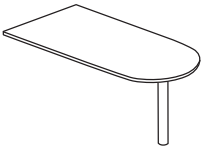
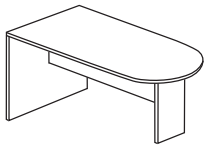
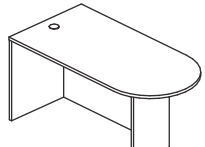
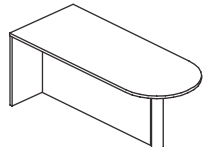
D ISLAND – T LEG		Model #	W	D	Wt	V	TFL \$	HPL \$	Remarks			
 SIN 711-2	24" Deep	3 DT 4824	48	24	65	5.0			D Island – T Modesty <ul style="list-style-type: none"> Includes top, end panel, support panel, post leg and hardware Post leg comes in Black To order Nickel leg add "N" to end of code (add \$105 List) 			
		3 DT 6024	60	24	79	5.5						
		3 DT 7224	72	24	94	5.5						
	30" Deep	3 DT 6030	60	30	90	5.5						
		3 DT 6630	66	30	96	6.0						
		3 DT 7230	72	30	103	6.0						
	36" Deep	3 DT 7830	78	30	110	6.5						
		3 DT 6036	60	36	103	6.0						
		3 DT 6636	66	36	107	6.3						
3 DT 7236	72	36	110	6.5								
D ISLAND – PARTIAL / WALL ACCESS MODESTY												
 SIN 711-2	Partial Modesty	24" Deep	3 DP 4824	48	24	60	5.0		D Island – Partial/Wall Access Modesty <ul style="list-style-type: none"> Includes top, end panel, support panels, post leg, hardware and grommet Partial (DP) modesty gives 16" floor clearance Wall access (DPQ) modesty gives 20" floor clearance Post leg comes in Black To order Nickel leg add "N" to end of code (add \$105 List) Cover hides wire access hole when one side of unit is exposed Partial user modesty can be added to 72" models. Order 3 DMP 7212 @ \$ 152 list. 			
			3 DP 6024	60	24	74	5.5					
			3 DP 7224	72	24	89	5.5					
	30" Deep	3 DP 6030	60	30	85	5.5						
		3 DP 7230	72	30	98	6.0						
	Wall Access Modesty	24" Deep	3 DPQ 4824	48	24	60	5.0					
			3 DPQ 6024	60	24	74	5.5					
	30" Deep	3 DPQ 6030	60	30	85	5.5						
		3 DPQ 6630	66	30	91	6.0						
3 DPQ 7230		72	30	98	6.0							
D TOP – NO MODESTY												
 SIN 711-2	24" Deep	3 DN 3624	36	24	32	4.0			D Top - No Modesty <ul style="list-style-type: none"> Includes top, post leg and hardware Post leg comes in Black To order Nickel leg add "N" to end of code (add \$105 List) 			
		3 DN 4224	42	24	38	4.3						
		3 DN 4824	48	24	44	4.5						
	30" Deep	3 DN 4830	48	30	53	4.5						
		3 DN 6030	60	30	60	5.0						
		3 DN 6630	66	30	66	5.0						
D ISLAND – PARTIAL MODESTY												
 SIN 711-2	30" Deep	3 DM 6030	60	30	96	5.5			Partial Modesty <ul style="list-style-type: none"> Includes top, 11" D modesty, end panel, leg panel and hardware Modesty is non-handed to mount inboard, outboard or centered 			
		3 DM 6630	66	30	104	6.0						
		3 DM 7230	72	30	111	6.5						
	36" Deep	3 DM 6036	60	36	108	7.2						
		3 DM 6636	66	36	116	7.6						
		3 DM 7236	72	36	123	8.0						
D ISLAND – FULL MODESTY												
 SIN 711-2	30" Deep	3 DMF 6030	60	30	101	5.5			Full Modesty <ul style="list-style-type: none"> Includes top, full height modesty, end panel, leg panel, hardware and grommet Modesty is non-handed to mount inboard, outboard or centered 			
		3 DMF 6630	66	30	109	6.0						
		3 DMF 7230	72	30	116	6.5						
	36" Deep	3 DMF 7236	72	36	128	8.0						
		D ISLAND – FULL LEG MODESTY										
		 SIN 711-2	30" Deep	3 DMFP 6030	60	30	100	5.5				Full Post-Leg Modesty <ul style="list-style-type: none"> Includes top, full height modesty, end panel, post leg and hardware
3 DMFP 6630	66			30	108	6.0						
3 DMFP 7230	72			30	116	6.5						
36" Deep	3 DMFP 7236		72	36	128	8.0						

LEGEND: W=width; D=depth (inches); Wt=shipping weight (lbs); V=volume (cubic feet); TFL \$=thermally fused laminate \$; HPL \$= high pressure laminate \$

"P" & "K" ISLANDS







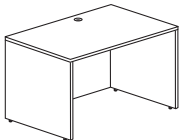

P ISLAND LEFT – T LEG		Model #	W	A	B	Wt	V	TFL \$	HPL \$	Remarks	
		3 PT 6030 L	60	36	30	99	5.6			<p>P Islands</p> <ul style="list-style-type: none"> Includes top, end panel, support panel, post leg and hardware Post leg comes in Black To order Nickel leg add "N" to end of code (add \$105 List) <p>Extended Modesty</p> <ul style="list-style-type: none"> Includes top, 12" D modesty, end panel, leg panel and hardware Modesty is non-handed to mount outboard or centered <p>Full Modesty</p> <ul style="list-style-type: none"> Includes top, full height modesty, end panel, leg panel and hardware <p>K Islands</p> <ul style="list-style-type: none"> Includes top, end panel, support panel, post leg and hardware Post leg comes in Black To order Nickel leg add "N" to end of code (add \$105 List) Curved corner work area Uses 3 KM 2813CL keyboard (see page 7-2) 	
		3 PT 6630 L	66	36	30	103	6.0				
		3 PT 7230 L	72	36	30	108	6.5				
		3 PT 7236 L	72	42	36	119	7.0				
		P ISLAND LEFT – PARTIAL MODESTY									
				3 PM 6030 L	60	36	30	106	5.6		
3 PM 6630 L	66			36	30	114	6.0				
3 PM 7230 L	72			36	30	121	6.5				
		3 PM 7236 L	72	42	36	133	8.0				
		3 PM 8436 L	84	42	36	155	8.5				
		P ISLAND LEFT – FULL MODESTY									
		3 PMF 6630 L	66	36	30	119	6.0				
		3 PMF 7230 L	72	36	30	126	6.5				
		3 PMF 7236 L	72	42	36	138	8.0				
K ISLAND LEFT – T LEG											
		20" Connect	72	36	20	136	7.5				
		24" Connect	72	36	24	136	7.5				
P ISLAND RIGHT – T LEG											
		3 PT 6030 R	60	36	30	99	5.6				
		3 PT 6630 R	66	36	30	103	6.0				
		3 PT 7230 R	72	36	30	108	6.5				
		3 PT 7236 R	72	42	36	119	7.0				
		P ISLAND RIGHT – PARTIAL MODESTY									
				3 PM 6030 R	60	36	30	106	5.6		
3 PM 6630 R	66			36	30	114	6.0				
3 PM 7230 R	72			36	30	121	6.5				
		3 PM 7236 R	72	42	36	133	8.0				
		3 PM 8436 R	84	42	36	155	8.5				
		P ISLAND RIGHT – FULL MODESTY									
		3 PMF 6630 R	66	36	30	119	6.0				
		3 PMF 7230 R	72	36	30	126	6.5				
		3 PMF 7236 R	72	42	36	138	8.0				
K ISLAND RIGHT – T LEG											
		20" Connect	72	36	20	136	7.5				
		24" Connect	72	36	24	136	7.5				

LEGEND: W=width; A=P depth; B=connection depth (inches); Wt=shipping weight (lbs); V=volume (cubic feet); TFL \$=thermally fused laminate \$; HPL \$= high pressure laminate \$

RECTANGULAR SHELLS

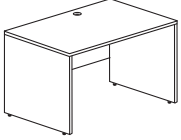
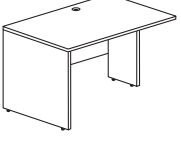

tree®

RECTANGULAR SHELLS – FULL MODESTY		Model #	W	D	Wt	V	TFL \$	HPL \$	Remarks	
 (X) 2 Full-Width Legs	20" Deep	3 TF 4220 (-)	42	20	65	5.1			Rectangular Shells <ul style="list-style-type: none"> Includes work surface, modesty panel, and two end panels (choose option X, Y or Z) Modesty panels are flush to the back Specify with Full Modesty (TF); Partial Modesty (TP); Wall Access Modesty (TPQ) Full Modesty (TF) same height as end panels Recessed end panels are 11"D Add either X, Y or Z for end panels End panels are non-handed Shells up to 48"W have one grommet – centred Shells 54"W and larger have 2 grommets – located in corners (see below) <div style="border: 1px solid black; width: 100px; height: 50px; margin: 10px auto; display: flex; justify-content: space-between; align-items: center;"> ○ ○ </div> <ul style="list-style-type: none"> 78" and longer Shells should have center support – see below Partial Modesty panels are 16" off the floor Shells ordered with Z (2 recessed) gables ship with 2 flat brackets only. If these tops are to be configured up against tops with no recessed gables, it is recommended to order a 3 BRPK 2 bracket pack (see pg. 1-13) Choosing a Pedestal <ul style="list-style-type: none"> Only 3 SHW 20 hanging peds fit 20"D shells 20"D pedestals go with 24"D TF's and TP's 24"D and 29"D pedestals go with 30"D TF's and TP's Optional Center Supports for Longer Tops <div style="display: flex; align-items: center; margin: 5px 0;"> <div style="margin-right: 10px;">24" D Tops</div> <div style="margin-right: 10px;">3 LGV 2808</div> <div style="margin-right: 10px;">\$91</div>  </div> <div style="display: flex; align-items: center; margin: 5px 0;"> <div style="margin-right: 10px;">30" D Tops</div> <div style="margin-right: 10px;">3 LGV 2812</div> <div style="margin-right: 10px;">\$116</div> </div> <ul style="list-style-type: none"> Recommended for 78" and 84" shells unless floor filing or storage used Attached using Mod-eez® clips and angle bracket 	
		3 TF 4820 (-)	48	20	71	5.8				
		3 TF 6020 (-)	60	20	99	4.5				
		3 TF 6620 (-)	66	20	108	4.8				
		3 TF 7220 (-)	72	20	118	5.1				
 (Y) 1 Full, 1 Recessed	24" Deep	3 TF 2424 (-)	24	24	58	3.1				
		3 TF 3024 (-)	30	24	64	3.8				
		3 TF 3624 (-)	36	24	72	4.5				
		3 TF 4224 (-)	42	24	82	5.1				
		3 TF 4824 (-)	48	24	88	5.8				
		3 TF 5424 (-)	54	24	97	4.2				
		3 TF 6024 (-)	60	24	106	4.5				
		3 TF 6624 (-)	66	24	115	4.8				
		3 TF 7224 (-)	72	24	125	5.1				
		3 TF 7824 (-)	78	24	134	5.4				
 (Y) 1 Recessed, 1 Full	30" Deep	3 TF 2430 (-)	24	30	66	3.1				
		3 TF 3030 (-)	30	30	73	3.8				
		3 TF 3630 (-)	36	30	80	4.5				
		3 TF 4230 (-)	42	30	89	5.1				
		3 TF 4830 (-)	48	30	96	5.8				
		3 TF 5430 (-)	54	30	106	4.2				
		3 TF 6030 (-)	60	30	113	4.5				
		3 TF 6630 (-)	66	30	121	4.8				
		3 TF 7230 (-)	72	30	132	5.1				
		3 TF 7830 (-)	78	30	143	5.4				
 (Z) 2 Recessed Legs		3 TF 8430 (-)	84	24	144	5.8				
		3 TF 2430 (-)	24	30	66	3.1				
		3 TF 3030 (-)	30	30	73	3.8				
		3 TF 3630 (-)	36	30	80	4.5				
		3 TF 4230 (-)	42	30	89	5.1				
 (Y) 1 Recessed, 1 Full		3 TF 4830 (-)	48	30	96	5.8				
		3 TF 5430 (-)	54	30	106	4.2				
		3 TF 6030 (-)	60	30	113	4.5				
		3 TF 6630 (-)	66	30	121	4.8				
		3 TF 7230 (-)	72	30	132	5.1				
		3 TF 7830 (-)	78	30	143	5.4				
		3 TF 8430 (-)	84	30	153	5.8				
		 (X) 2 Full-Width Legs	20" Deep	3 TP 4220 (-)	42	20	53	5.1		
				3 TP 4820 (-)	48	20	57	5.8		
				3 TP 6020 (-)	60	20	85	4.5		
3 TP 6620 (-)	66			20	94	4.8				
3 TP 7220 (-)	72			20	102	5.1				
 (Y) 1 Full, 1 Recessed	24" Deep	3 TP 2424 (-)	24	24	51	3.1				
		3 TP 3024 (-)	30	24	57	3.8				
		3 TP 3624 (-)	36	24	65	4.5				
		3 TP 4224 (-)	42	24	73	5.1				
		3 TP 4824 (-)	48	24	79	5.8				
		3 TP 5424 (-)	54	24	87	4.2				
		3 TP 6024 (-)	60	24	95	4.5				
		3 TP 6624 (-)	66	24	101	4.8				
		3 TP 7224 (-)	72	24	110	5.1				
		3 TP 7824 (-)	78	24	121	5.4				
 (Y) 1 Recessed, 1 Full	30" Deep	3 TP 8424 (-)	84	24	132	5.8				
		3 TP 2430 (-)	24	30	63	3.1				
		3 TP 3030 (-)	30	30	70	3.8				
		3 TP 3630 (-)	36	30	77	4.5				
		3 TP 4230 (-)	42	30	85	5.1				
		3 TP 4830 (-)	48	30	92	5.8				
		3 TP 5430 (-)	54	30	102	4.2				
		3 TP 6030 (-)	60	30	105	4.5				
		3 TP 6630 (-)	66	30	110	4.8				
		3 TP 7230 (-)	72	30	115	5.1				
 (Z) 2 Recessed Legs		3 TP 7830 (-)	78	30	130	5.4				
		3 TP 8430 (-)	84	30	144	5.8				

Must enter X, Y or Z to define legs

Must enter X, Y or Z to define legs

LEGEND: W=width; D=depth (inches); Wt=shipping weight (lbs); V=volume (cubic feet); TFL \$=thermally fused laminate \$; HPL \$= high pressure laminate \$

RECTANGULAR SHELLS

RECTANGULAR SHELLS—WALL ACCESS MODESTY

Model #	W	D	Wt	V	TFL \$	HPL \$
---------	---	---	----	---	--------	--------

Remarks

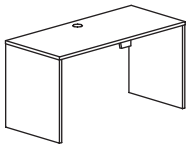

(X) 2 Full-Width Legs

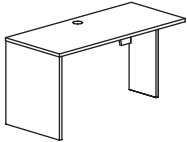

(Y) 1 Full, 1 Recessed

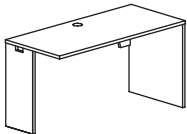

(Y) 1 Recessed, 1 Full

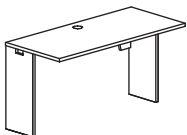

(Z) 2 Recessed Legs

SIN 711-2

20" Deep	3 TPQ 6020 (-)	60	20	85	4.5	
	3 TPQ 6620 (-)	66	20	94	4.8	
	3 TPQ 7220 (-)	72	20	102	5.1	
24" Deep	3 TPQ 2424 (-)	24	24	51	3.1	
	3 TPQ 3024 (-)	30	24	57	3.8	
	3 TPQ 3624 (-)	36	24	65	4.5	
	3 TPQ 4224 (-)	42	24	73	5.1	
	3 TPQ 4824 (-)	48	24	79	5.8	
	3 TPQ 5424 (-)	54	24	87	4.2	
	3 TPQ 6024 (-)	60	24	95	4.5	
	3 TPQ 6624 (-)	66	24	101	4.8	
	3 TPQ 7224 (-)	72	24	110	5.1	
30" Deep	3 TPQ 7824 (-)	78	24	121	5.4	
	3 TPQ 8424 (-)	84	24	132	5.8	
	3 TPQ 2430 (-)	24	30	63	3.1	
	3 TPQ 3030 (-)	30	30	70	3.8	
	3 TPQ 3630 (-)	36	30	77	4.5	
	3 TPQ 4230 (-)	42	30	85	5.1	
	3 TPQ 4830 (-)	48	30	92	5.8	
	3 TPQ 5430 (-)	54	30	102	4.2	
	3 TPQ 6030 (-)	60	30	105	4.5	
	3 TPQ 6630 (-)	66	30	110	4.8	
	3 TPQ 7230 (-)	72	30	115	5.1	
3 TPQ 7830 (-)	78	30	130	5.4		
3 TPQ 8430 (-)	84	30	144	5.8		

MODESTY OPTIONS

Must enter X, Y or Z to define legs

TF Modesty
(Full to the floor)



TP Modesty
(16" off floor)

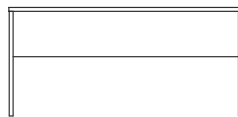

TPQ Modesty
(20" off floor)

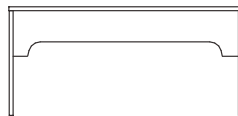

Rectangular Shells

- Includes work surface, modesty panel, and two end panels (choose option X, Y or Z)
- Modesty panels are flush to the back
- TPQ modesty gives 20" clearance above floor
- Recessed end panels are 11"D
- Add either X, Y or Z for end panels
- End panels are non-handed
- Shells up to 48"W have one grommet – centred
- Shells 54"W and larger have 2 grommets – located in corners (see below)



- Shells ordered with Z (2 recessed) gables ship with 2 flat brackets only. If these tops are to be configured up against tops with no recessed gables, it is recommended to order a 3 BRPK 2 bracket pack (see pg. 1-13)

Choosing a Pedestal

- Only 3 SHW 20 hanging peds fit 20"D shells
- 20"D pedestals go with 24"D TF's and TP's
- 24"D and 29"D pedestals go with 30"D TF's and TP's

SPARE END PANELS

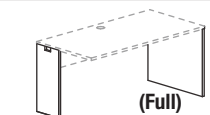

(Recessed)

SIN 711-2

Recessed	3 LGW 12	11	27	8	0.5
Full – 24"D	3 LGW 24	24	27	17	0.9
Full – 30"D	3 LGW 30	30	27	21	1.1

END PANELS: WHEELCHAIR ACCESSIBLE

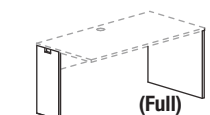

(Recessed)

SIN 711-2

Recessed	3 LGW 1232	11	31	9	0.5
Full – 24"D	3 LGW 2432	24	31	19	0.9
Full – 30"D	3 LGW 3032	30	31	23	1.1
Corner Post	3 LCP 32	4	31	18	0.7

- For use in converting shells between X, Y and Z configurations

- Including glides, end panels are 27¹/₂"

- Use to retrofit standard height corners and desk shells to wheelchair height
- Standard modesty panels fit, but rise additional 4" from floor
- Keep standard end panels should desk need to be lowered back to standard height
- Finished desk height = 32¹/₂"

LEGEND: W=width; D=depth (inches); Wt=shipping weight (lbs); V=volume (cubic feet); TFL \$=thermally fused laminate \$; HPL \$= high pressure laminate \$

CURVED SHELLS – LEFT



tree®

CURVED SHELLS (LEFT) – FULL MODESTY

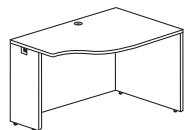

(Y) 1 Recessed, 1 Full

24" Deep, 20" Join



Model #	W	D	C	Wt	V	TFL \$	HPL \$
3 TF 2424 L20 C (-)	24	24	20	58	3.1		
3 TF 3024 L20 C (-)	30	24	20	61	3.8		
3 TF 3624 L20 C (-)	36	24	20	64	4.5		
3 TF 4224 L20 C (-)	42	24	20	72	5.1		
3 TF 4824 L20 C (-)	48	24	20	82	5.8		
3 TF 5424 L20 C (-)	54	24	20	88	4.2		
3 TF 6024 L20 C (-)	60	24	20	97	4.5		
3 TF 6624 L20 C (-)	66	24	20	106	4.8		
3 TF 7224 L20 C (-)	72	24	20	115	5.1		

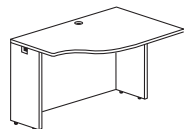

(Z) 2 Recessed Legs

SIN 711-2

30" Deep, 24" Join



3 TF 2430 L24 C (-)	24	30	24	66	3.1		
3 TF 3030 L24 C (-)	30	30	24	73	3.8		
3 TF 3630 L24 C (-)	36	30	24	80	4.5		
3 TF 4230 L24 C (-)	42	30	24	89	5.1		
3 TF 4830 L24 C (-)	48	30	24	96	5.8		
3 TF 5430 L24 C (-)	54	30	24	106	4.2		
3 TF 6030 L24 C (-)	60	30	24	113	4.5		
3 TF 6630 L24 C (-)	66	30	24	121	4.8		
3 TF 7230 L24 C (-)	72	30	24	132	5.1		

CURVED SHELLS (LEFT) – WALL ACCESS MODESTY

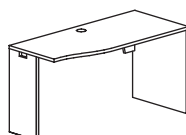

(Y) 1 Recessed, 1 Full

24" Deep, 20" Join



3 TPQ 2424 L20 C (-)	24	24	20	51	3.1		
3 TPQ 3024 L20 C (-)	30	24	20	57	3.8		
3 TPQ 3624 L20 C (-)	36	24	20	65	4.5		
3 TPQ 4224 L20 C (-)	42	24	20	73	5.1		
3 TPQ 4824 L20 C (-)	48	24	20	79	5.8		
3 TPQ 5424 L20 C (-)	54	24	20	87	4.2		
3 TPQ 6024 L20 C (-)	60	24	20	95	4.5		
3 TPQ 6624 L20 C (-)	66	24	20	101	4.8		
3 TPQ 7224 L20 C (-)	72	24	20	110	5.1		

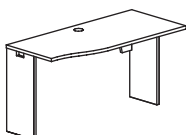

(Z) 2 Recessed Legs

SIN 711-2

30" Deep, 24" Join



3 TPQ 2430 L24 C (-)	24	30	24	63	3.1		
3 TPQ 3030 L24 C (-)	30	30	24	70	3.8		
3 TPQ 3630 L24 C (-)	36	30	24	77	4.5		
3 TPQ 4230 L24 C (-)	42	30	24	85	5.1		
3 TPQ 4830 L24 C (-)	48	30	24	92	5.8		
3 TPQ 5430 L24 C (-)	54	30	24	102	4.2		
3 TPQ 6030 L24 C (-)	60	30	24	105	4.5		
3 TPQ 6630 L24 C (-)	66	30	24	110	4.8		
3 TPQ 7230 L24 C (-)	72	30	24	115	5.1		

CURVED SHELLS (LEFT) – PARTIAL MODESTY

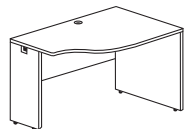

(Y) 1 Recessed, 1 Full

24" Deep, 20" Join



3 TP 2424 L20 C (-)	24	24	20	51	3.1		
3 TP 3024 L20 C (-)	30	24	20	57	3.8		
3 TP 3624 L20 C (-)	36	24	20	65	4.5		
3 TP 4224 L20 C (-)	42	24	20	73	5.1		
3 TP 4824 L20 C (-)	48	24	20	79	5.8		
3 TP 5424 L20 C (-)	54	24	20	87	4.2		
3 TP 6024 L20 C (-)	60	24	20	95	4.5		
3 TP 6624 L20 C (-)	66	24	20	101	4.8		
3 TP 7224 L20 C (-)	72	24	20	110	5.1		

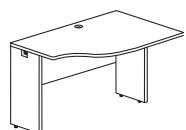

(Z) 2 Recessed Legs

SIN 711-2

30" Deep, 24" Join



3 TP 2430 L24 C (-)	24	30	24	63	3.1		
3 TP 3030 L24 C (-)	30	30	24	70	3.8		
3 TP 3630 L24 C (-)	36	30	24	77	4.5		
3 TP 4230 L24 C (-)	42	30	24	85	5.1		
3 TP 4830 L24 C (-)	48	30	24	92	5.8		
3 TP 5430 L24 C (-)	54	30	24	102	4.2		
3 TP 6030 L24 C (-)	60	30	24	105	4.5		
3 TP 6630 L24 C (-)	66	30	24	110	4.8		
3 TP 7230 L24 C (-)	72	30	24	115	5.1		

↑
Must enter either Y or Z to define legs.

Curved Shells

- Fits Corners with matching connection depth
- Includes worksurface, modesty panel, and two end panels
- Must add Y or Z for end panel combination
- End panels are non-handed
- Recessed end panels are 11"D
- Modesty panels are flush to the back
- Shells up to 48"W have one grommet – centred
- Shells 54"W and larger have 2 grommets – located in corners

Curves

- Length of curve in Curved Shells:
 - 24" deep, 20" join → 20.5"
 - 30" deep, 24" join → 20.5"
 - 30" deep, 20" join → 27"
 - ie. for 30" deep Shell (24" Join) would need a 54" Shell to fit a 30" Lateral File → 30" (lateral) + 20.5" (curve) + 1" (panel) = 51.5", closest size is 54"
- Minimum length of Curved Shells to allow for a pedestal:
 - 3 TF 3624 L20 C Z
 - 3 TF 3630 L24 C Z
 - 3 TF 4230 L20 C Z
- Minimum length Curved Shells allowing for a 30" Lateral File
 - 3 TF 5424 L20 C Z
 - 3 TF 5430 L24 C Z
 - 3 TF 6030 L20 C Z
- Minimum length Curved Shell allowing for a 36" Lateral File
 - 3 TF 6024 L20 C Z
 - 3 TF 6030 L24 C Z
 - 3 TF 6630 L20 C Z

Choosing a Pedestal

- 20"D pedestals go with 24"D TF's and TP's
- 24"D and 29"D pedestals go with 30"D TF's and TP's

NOTE:

- 30"D Shells curving down to 20" join also available.
Order as **3TF / TP / TPQ xx30 L20 C (-)**
- Add \$25 List to similar 30"D Shells curving down to 24" join
- Shells ordered with Z (2 recessed) gables ship with 2 flat brackets only. If these tops are to be configured up against tops with no recessed gables, it is recommended to order a 3 BRPK 2 bracket pack (see pg. 1-13)
- If NMSO requires, will cut curved end to 18"D

LEGEND: W=width; D=depth; C=connection depth (inches); Wt=shipping weight (lbs); V=volume (cubic feet); TFL \$=thermally fused laminate \$; HPL \$= high pressure laminate \$

CURVED SHELLS – RIGHT

CURVED SHELLS (RIGHT) – FULL MODESTY

Model # W D C Wt V TFL \$ HPL \$

Remarks

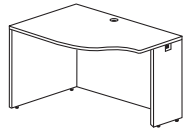

(Y) 1 Recessed, 1 Full

24" Deep, 20" Join



3 TF 2424 R20 C (-)	24	24	20	58	3.1
3 TF 3024 R20 C (-)	30	24	20	61	3.8
3 TF 3624 R20 C (-)	36	24	20	64	4.5
3 TF 4224 R20 C (-)	42	24	20	72	5.1
3 TF 4824 R20 C (-)	48	24	20	82	5.8
3 TF 5424 R20 C (-)	54	24	20	88	4.2
3 TF 6024 R20 C (-)	60	24	20	97	4.5
3 TF 6624 R20 C (-)	66	24	20	106	4.8
3 TF 7224 R20 C (-)	72	24	20	115	5.1

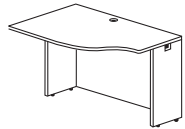

(Z) 2 Recessed Legs

SIN 711-2

30" Deep, 24" Join



3 TF 2430 R24 C (-)	24	30	24	66	3.1
3 TF 3030 R24 C (-)	30	30	24	73	3.8
3 TF 3630 R24 C (-)	36	30	24	80	4.5
3 TF 4230 R24 C (-)	42	30	24	89	5.1
3 TF 4830 R24 C (-)	48	30	24	96	5.8
3 TF 5430 R24 C (-)	54	30	24	106	4.2
3 TF 6030 R24 C (-)	60	30	24	113	4.5
3 TF 6630 R24 C (-)	66	30	24	121	4.8
3 TF 7230 R24 C (-)	72	30	24	132	5.1

Curved Shells

- Fits Corners with matching connection depth
- Includes worksurface, modesty panel, and two end panels
- Must add Y or Z for end panel combination
- End panels are non-handed
- Recessed end panels are 11"D
- Modesty panels are flush to the back
- Shells up to 48"W have one grommet – centred
- Shells 54"W and larger have 2 grommets – located in corners

Curves

- Length of curve in Curved Shells:
 - 24" deep, 20" join → 20.5"
 - 30" deep, 24" join → 20.5"
 - 30" deep, 20" join → 27"
 - ie. for 30" deep Shell (24" Join) would need a 54" Shell to fit a 30" Lateral File → 30" (lateral) + 20.5" (curve) + 1" (panel) = 51.5", closest size is 54"

- Minimum length of Curved Shells to allow for a pedestal:
 - 3 TF 3624 R20 C Z
 - 3 TF 3630 R24 C Z
 - 3 TF 4230 R20 C Z

- Minimum length Curved Shells allowing for a 30" Lateral File
 - 3 TF 5424 R20 C Z
 - 3 TF 5430 R24 C Z
 - 3 TF 6030 R20 C Z

- Minimum length Curved Shell allowing for a 36" Lateral File
 - 3 TF 6024 R20 C Z
 - 3 TF 6030 R24 C Z
 - 3 TF 6630 R20 C Z

CURVED SHELLS (RIGHT) – WALL ACCESS MODESTY

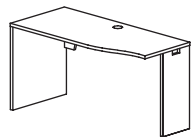

(Y) 1 Recessed, 1 Full

24" Deep, 20" Join



3 TPQ 2424 R20 C (-)	24	24	20	51	3.1
3 TPQ 3024 R20 C (-)	30	24	20	57	3.8
3 TPQ 3624 R20 C (-)	36	24	20	65	4.5
3 TPQ 4224 R20 C (-)	42	24	20	73	5.1
3 TPQ 4824 R20 C (-)	48	24	20	79	5.8
3 TPQ 5424 R20 C (-)	54	24	20	87	4.2
3 TPQ 6024 R20 C (-)	60	24	20	95	4.5
3 TPQ 6624 R20 C (-)	66	24	20	101	4.8
3 TPQ 7224 R20 C (-)	72	24	20	110	5.1

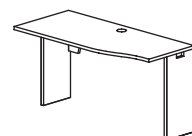

(Z) 2 Recessed Legs

SIN 711-2

30" Deep, 24" Join



3 TPQ 2430 R24 C (-)	24	30	24	63	3.1
3 TPQ 3030 R24 C (-)	30	30	24	70	3.8
3 TPQ 3630 R24 C (-)	36	30	24	77	4.5
3 TPQ 4230 R24 C (-)	42	30	24	85	5.1
3 TPQ 4830 R24 C (-)	48	30	24	92	5.8
3 TPQ 5430 R24 C (-)	54	30	24	102	4.2
3 TPQ 6030 R24 C (-)	60	30	24	105	4.5
3 TPQ 6630 R24 C (-)	66	30	24	110	4.8
3 TPQ 7230 R24 C (-)	72	30	24	115	5.1

CURVED SHELLS (RIGHT) – PARTIAL MODESTY

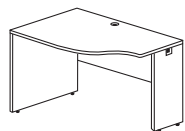

(Y) 1 Recessed, 1 Full

24" Deep, 20" Join



3 TP 2424 R20 C (-)	24	24	20	51	3.1
3 TP 3024 R20 C (-)	30	24	20	57	3.8
3 TP 3624 R20 C (-)	36	24	20	65	4.5
3 TP 4224 R20 C (-)	42	24	20	73	5.1
3 TP 4824 R20 C (-)	48	24	20	79	5.8
3 TP 5424 R20 C (-)	54	24	20	87	4.2
3 TP 6024 R20 C (-)	60	24	20	95	4.5
3 TP 6624 R20 C (-)	66	24	20	101	4.8
3 TP 7224 R20 C (-)	72	24	20	110	5.1

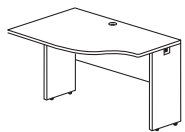

(Z) 2 Recessed Legs

SIN 711-2

30" Deep, 24" Join



3 TP 2430 R24 C (-)	24	30	24	63	3.1
3 TP 3030 R24 C (-)	30	30	24	70	3.8
3 TP 3630 R24 C (-)	36	30	24	77	4.5
3 TP 4230 R24 C (-)	42	30	24	85	5.1
3 TP 4830 R24 C (-)	48	30	24	92	5.8
3 TP 5430 R24 C (-)	54	30	24	102	4.2
3 TP 6030 R24 C (-)	60	30	24	105	4.5
3 TP 6630 R24 C (-)	66	30	24	110	4.8
3 TP 7230 R24 C (-)	72	30	24	115	5.1

Choosing a Pedestal

- 20"D pedestals go with 24"D TF's and TP's
- 24"D and 29"D pedestals go with 30"D TF's and TP's

NOTE:

- 30"D Shells curving down to 20" join also available. Order as **3TF / TP / TPQ xx30 R20 C (-)**
- Add \$25 List to similar 30"D Shells curving down to 24" join
- Shells ordered with Z (2 recessed) gables ship with 2 flat brackets only. If these tops are to be configured up against tops with no recessed gables, it is recommended to order a 3BRPK2 bracket pack (see pg. 1-13)
- If NMSO requires, will cut curved end to 18"D

Must enter either Y or Z to define legs.

LEGEND: W=width; D=depth; C=connection depth (inches); Wt=shipping weight (lbs); V=volume (cubic feet); TFL \$=thermally fused laminate \$; HPL \$= high pressure laminate \$

CORNER TOPS

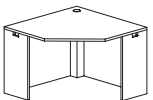
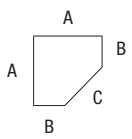
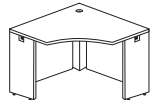
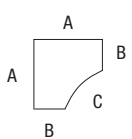
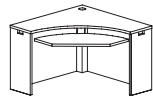
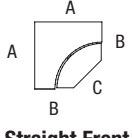
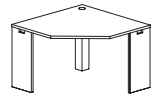
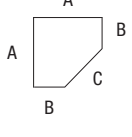
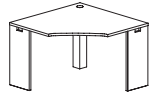
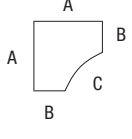
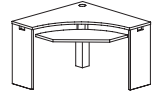
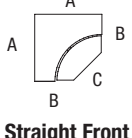
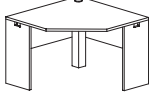
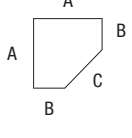
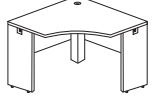
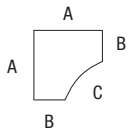
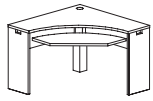
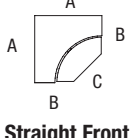

tree®

CORNER – FULL MODESTY		Model #	A	B	C	Wt	V	TFL \$	HPL \$	Remarks
 <p>Straight (S) SIN 711-2</p>		3 CF 3620 S	36	20	23	80	5.2			<p>Corners</p> <ul style="list-style-type: none"> Includes top, 2 modesty panels, 2 support panels and leg Includes one grommet Modesty panels are non-handed See pg. 1-20 to view modesty options Modesty panels are inter-changeable between full and partial modesty units. Thus, corners can have mixed full and partial modesties. To do this, order appropriate numbers of full and partial modesty corner units and inter-change the modesties Corner leg is hollow to provide wire management conduit Corner leg comes assembled Corners have 3" round grommet Recessed end panels are 11"D Single arm integrated keyboard corners have "KM" style (low) mechanisms (see pg 7-2 for details) Double arm integrated keyboard corners have "KF" (Full Flex) mechanisms (see pg 7-2 for details) Keyboard platform is 15"D Includes one grommet If NMSO requires, will cut connection to 18"D <p>Full Gable Options</p> <ul style="list-style-type: none"> For two full legs on corner units, add "X" to code; add \$100 to List price For one full / one partial leg, add "Y" to code; add \$100 to List price Standard code ships with 2 partial legs
		3 CF 3624 S	36	24	17	80	5.2			
		3 CF 4224 S	42	24	25	98	6.7			
		3 CF 4824 S	48	24	34	107	7.5			
		3 CF 4830 S	48	30	25	107	7.5			
 <p>Curve (C) SIN 711-2</p>		3 CF 3620 C	36	20	23	80	5.2			
		3 CF 3624 C	36	24	17	80	5.2			
		3 CF 4224 C	42	24	25	98	6.7			
		3 CF 4824 C	48	24	34	107	7.5			
		3 CF 4830 C	48	30	25	107	7.5			
 <p>Integrated Keyboard Corners SIN 711-2</p>	 <p>Straight Front</p>	Single Arm KB								
		3 CFK 4224 S	42	24	25	116	8.2			
		Double Arm KB								
		3 CFF 4224 S	42	24	25	132	8.2			
CORNER – WALL ACCESS MODESTY										
 <p>Straight (S) SIN 711-2</p>		3 CPQ 3620 S	36	20	23	69	5.2			
		3 CPQ 3624 S	36	24	17	69	5.2			
		3 CPQ 4224 S	42	24	25	89	6.7			
		3 CPQ 4824 S	48	24	34	106	7.5			
		3 CPQ 4830 S	48	30	25	106	7.5			
 <p>Curve (C) SIN 711-2</p>		3 CPQ 3620 C	36	20	23	69	5.2			
		3 CPQ 3624 C	36	24	17	69	5.2			
		3 CPQ 4224 C	42	24	25	89	6.7			
		3 CPQ 4824 C	48	24	34	106	7.5			
		3 CPQ 4830 C	48	30	25	106	7.5			
 <p>Integrated Keyboard Corners SIN 711-2</p>	 <p>Straight Front</p>	Single Arm KB								
		3 CPQK 4224 S	42	24	25	116	8.2			
		Double Arm KB								
		3 CPQF 4224 S	42	24	25	132	8.2			
CORNER – PARTIAL MODESTY										
 <p>Straight (S) SIN 711-2</p>		3 CP 3620 S	36	20	23	69	5.2			
		3 CP 3624 S	36	24	17	69	5.2			
		3 CP 4224 S	42	24	25	89	6.7			
		3 CP 4824 S	48	24	34	106	7.5			
		3 CP 4830 S	48	30	25	106	7.5			
 <p>Curve (C) SIN 711-2</p>		3 CP 3620 C	36	20	23	69	5.2			
		3 CP 3624 C	36	24	17	69	5.2			
		3 CP 4224 C	42	24	25	89	6.7			
		3 CP 4824 C	48	24	34	106	7.5			
		3 CP 4830 C	48	30	25	106	7.5			
 <p>Integrated Keyboard Corners SIN 711-2</p>	 <p>Straight Front</p>	Single Arm KB								
		3 CPK 4224 S	42	24	25	107	8.2			
		Double Arm KB								
		3 CPF 4224 S	42	24	25	123	8.2			

LEGEND: A=back; B=join; C=work area (inches); Wt=shipping weight (lbs); V=volume (cubic feet); TFL \$=thermally fused laminate \$; HPL \$= high pressure laminate \$

EXTENDED CORNER TOPS – LEFT

EXTENDED CORNERS (LEFT) – FULL MODESTY		Model #	A	B	C	D	Wt	V	TFL \$	HPL \$	Remarks
 (X) 2 Full-Width Legs	36" Corner, 20" Join	3 CEF 3620 L60 (-)	60	36	20	24	141	8.5			Extended Corners <ul style="list-style-type: none"> Includes top, 2 full modesty panels, corner leg and 2 end panels Must complete the code by choosing either X, Y or Z end panel combination Includes two grommets: one in corner and one at extended end Corner leg is hollow to permit use as wire management conduit Recessed end panels are 11"D Uses 3 KM 2813CL keyboard (see page 7-2) See page 1-20 to view modesty options
		3 CEF 3620 L66 (-)	66	36	20	24	147	9.5			
		3 CEF 3620 L72 (-)	72	36	20	24	154	10.0			
	 (Y) 1 Full, 1 Recessed	36" Corner, 24" Join	3 CEF 3624 L54 (-)	54	36	24	24	135	7.9		
3 CEF 3624 L60 (-)			60	36	24	24	141	8.5			
3 CEF 3624 L66 (-)			66	36	24	24	148	9.5			
 (Y) 1 Recessed, 1 Full		42" Corner, 24" Join	3 CEF 4224 L72 (-)	72	36	24	24	155	10.0		
	3 CEF 4224 L84 (-)		84	36	24	24	169	11.4			
	3 CEF 4224 L60 (-)		60	42	24	24	148	9.9			
	 (Z) 2 Recessed Legs SIN 711-2	48" Corner, 24" Join	3 CEF 4224 L66 (-)	66	42	24	24	155	10.5		
3 CEF 4224 L72 (-)			72	42	24	24	162	11.0			
3 CEF 4224 L84 (-)			84	42	24	24	175	12.1			
		48" Corner, 24" Join	3 CEF 4824 L72 (-)	72	48	24	24	169	12.0		
		↑ Must enter X, Y or Z to define legs									
EXT'D CORNERS (LEFT) – WALL ACCESS MODESTY											
 (X) 2 Full-Width Legs	36" Corner, 24" Join	3 CEPQ 3624 L54 (-)	54	36	24	24	111	7.9			<ul style="list-style-type: none"> Includes top, 2 wall access modesty panels, corner leg and 2 end panels Must complete the code by choosing either X, Y or Z end panel combination Includes two grommets: one in corner and one at extended end Corner leg is hollow to permit use as wire management conduit Recessed end panels are 11"D Uses 3 KM 2813CL keyboard (see page 7-2) See page 1-20 to view modesty options
		3 CEPQ 3624 L60 (-)	60	36	24	24	116	8.5			
		3 CEPQ 3624 L66 (-)	66	36	24	24	121	9.5			
		3 CEPQ 3624 L72 (-)	72	36	24	24	126	10.0			
 (Y) 1 Full, 1 Recessed	42" Corner, 24" Join	3 CEPQ 3624 L84 (-)	84	36	24	24	136	11.4			
		3 CEPQ 4224 L60 (-)	60	42	24	24	121	9.9			
		3 CEPQ 4224 L66 (-)	66	42	24	24	126	10.5			
	 (Y) 1 Recessed, 1 Full	42" Corner, 24" Join	3 CEPQ 4224 L72 (-)	72	42	24	24	131	11.0		
3 CEPQ 4224 L84 (-)			84	42	24	24	141	12.1			
3 CEPQ 4224 L60 (-)			60	42	24	24	121	9.9			
 (Z) 2 Recessed Legs SIN 711-2		48" Corner, 24" Join	3 CEPQ 4224 L66 (-)	66	42	24	24	126	10.5		
	3 CEPQ 4224 L72 (-)		72	42	24	24	131	11.0			
	3 CEPQ 4224 L84 (-)		84	42	24	24	141	12.1			
		48" Corner, 24" Join	3 CEPQ 4824 L72 (-)	72	48	24	24	136	12.0		
		↑ Must enter X, Y or Z to define legs									
EXTENDED CORNERS (LEFT) – PARTIAL MODESTY											
 (X) 2 Full-Width Legs	36" Corner, 20" Join	3 CEP 3620 L60 (-)	60	36	20	24	115	8.5			<ul style="list-style-type: none"> Includes top, 2 partial modesty panels, corner leg and 2 end panels Must complete the code by choosing either X, Y or Z end panel combination Includes two grommets: one in corner and one at extended end Corner leg is hollow to permit use as wire management conduit Recessed end panels are 11"D Uses 3 KM 2813CL keyboard (see page 7-2)
		3 CEP 3620 L66 (-)	66	36	20	24	120	9.5			
		3 CEP 3620 L72 (-)	72	36	20	24	125	10.0			
	 (Y) 1 Full, 1 Recessed	36" Corner, 24" Join	3 CEP 3624 L54 (-)	54	36	24	24	111	7.9		
3 CEP 3624 L60 (-)			60	36	24	24	116	8.5			
3 CEP 3624 L66 (-)			66	36	24	24	121	9.5			
 (Y) 1 Recessed, 1 Full		42" Corner, 24" Join	3 CEP 3624 L72 (-)	72	36	24	24	126	10.0		
	3 CEP 3624 L84 (-)		84	36	24	24	136	11.4			
	3 CEP 4224 L60 (-)		60	42	24	24	121	9.9			
	 (Z) 2 Recessed Legs SIN 711-2	48" Corner, 24" Join	3 CEP 4224 L66 (-)	66	42	24	24	126	10.5		
3 CEP 4224 L72 (-)			72	42	24	24	131	11.0			
3 CEP 4224 L84 (-)			84	42	24	24	141	12.1			
		48" Corner, 24" Join	3 CEP 4824 L72 (-)	72	48	24	24	136	12.0		
		↑ Must enter X, Y or Z to define legs									

LEGEND: A=length; B=depth; C=join; D=join (inches); Wt=shipping weight (lbs); V=volume (cubic feet); TFL \$=thermally fused laminate \$; HPL \$= high pressure laminate \$

EXTENDED CORNER TOPS – RIGHT



tréo®

EXTENDED CORNERS (RIGHT) – FULL MODESTY		Model #	A	B	C	D	Wt	V	TFL \$	HPL \$	Remarks	
 (X) 2 Full-Width Legs	36" Corner, 20" Join	3 CEF 3620 R60 (-)	60	36	20	24	141	8.5			Extended Corners <ul style="list-style-type: none"> Includes top, 2 full modesty panels, corner leg and 2 end panels Must complete the code by choosing either X, Y or Z end panel combination Includes two grommets: one in corner and one at extended end Corner leg is hollow to permit use as wire management conduit Recessed end panels are 11"D Uses 3 KM 2813CL keyboard (see page 7-2) See page 1-20 to view modesty options 	
		3 CEF 3620 R66 (-)	66	36	20	24	147	9.5				
		3 CEF 3620 R72 (-)	72	36	20	24	154	10.0				
	 (Y) 1 Full, 1 Recessed	36" Corner, 24" Join	3 CEF 3624 R54 (-)	54	36	24	24	135	7.9			
3 CEF 3624 R60 (-)			60	36	24	24	141	8.5				
3 CEF 3624 R66 (-)			66	36	24	24	148	9.5				
3 CEF 3624 R72 (-)			72	36	24	24	155	10.0				
 (Y) 1 Recessed, 1 Full	42" Corner, 24" Join	3 CEF 4224 R60 (-)	60	42	24	24	148	9.9				
		3 CEF 4224 R66 (-)	66	42	24	24	155	10.5				
		3 CEF 4224 R72 (-)	72	42	24	24	162	11.0				
		3 CEF 4224 R84 (-)	84	42	24	24	175	12.1				
 (Z) 2 Recessed Legs SIN 711-2	48" Corner, 24" Join	3 CEF 4824 R72 (-)	72	48	24	24	169	12.0				
				Must enter X, Y or Z to define legs								
EXT'D CORNERS (RIGHT) – WALL ACCESS MODESTY												
 (X) 2 Full-Width Legs	36" Corner, 24" Join	3 CEPQ 3624 R54 (-)	54	36	24	24	111	7.9			<ul style="list-style-type: none"> Includes top, 2 wall access modesty panels, corner leg and 2 end panels Must complete the code by choosing either X, Y or Z end panel combination Includes two grommets: one in corner and one at extended end Corner leg is hollow to permit use as wire management conduit Recessed end panels are 11"D Uses 3 KM 2813CL keyboard (see page 7-2) See page 1-20 to view modesty options 	
		3 CEPQ 3624 R60 (-)	60	36	24	24	116	8.5				
		3 CEPQ 3624 R66 (-)	66	36	24	24	121	9.5				
		3 CEPQ 3624 R72 (-)	72	36	24	24	126	10.0				
 (Y) 1 Full, 1 Recessed	42" Corner, 24" Join	3 CEPQ 4224 R60 (-)	60	42	24	24	121	9.9				
		3 CEPQ 4224 R66 (-)	66	42	24	24	126	10.5				
		3 CEPQ 4224 R72 (-)	72	42	24	24	131	11.0				
		3 CEPQ 4224 R84 (-)	84	42	24	24	141	12.1				
 (Y) 1 Recessed, 1 Full	48" Corner, 24" Join	3 CEPQ 4824 R72 (-)	72	48	24	24	136	12.0				
				Must enter X, Y or Z to define legs								
				Must enter X, Y or Z to define legs								
				Must enter X, Y or Z to define legs								
EXTENDED CORNERS (RIGHT) – PARTIAL MOD.												
 (X) 2 Full-Width Legs	36" Corner, 20" Join	3 CEP 3620 R60 (-)	60	36	20	24	115	8.5			<ul style="list-style-type: none"> Includes top, 2 partial modesty panels, corner leg and 2 end panels Must complete the code by choosing either X, Y or Z end panel combination Includes two grommets: one in corner and one at extended end Corner leg is hollow to permit use as wire management conduit Recessed end panels are 11"D Uses 3 KM 2813CL keyboard (see page 7-2) 	
		3 CEP 3620 R66 (-)	66	36	20	24	120	9.5				
		3 CEP 3620 R72 (-)	72	36	20	24	125	10.0				
	 (Y) 1 Full, 1 Recessed	36" Corner, 24" Join	3 CEP 3624 R54 (-)	54	36	24	24	111	7.9			
3 CEP 3624 R60 (-)			60	36	24	24	116	8.5				
3 CEP 3624 R66 (-)			66	36	24	24	121	9.5				
3 CEP 3624 R72 (-)			72	36	24	24	126	10.0				
 (Y) 1 Recessed, 1 Full	42" Corner, 24" Join	3 CEP 4224 R60 (-)	60	42	24	24	121	9.9				
		3 CEP 4224 R66 (-)	66	42	24	24	126	10.5				
		3 CEP 4224 R72 (-)	72	42	24	24	131	11.0				
		3 CEP 4224 R84 (-)	84	42	24	24	141	12.1				
 (Z) 2 Recessed Legs SIN 711-2	48" Corner, 24" Join	3 CEP 4824 R72 (-)	72	48	24	24	136	12.0				
				Must enter X, Y or Z to define legs								

LEGEND: A=length; B=depth; C=join; D=join (inches); Wt=shipping weight (lbs); V=volume (cubic feet); TFL \$=thermally fused laminate \$; HPL \$= high pressure laminate \$

EXTENDED CORNER TOPS / ISLANDS WITH KEYBOARD



tree®

EXTENDED CORNERS – FULL MODESTY		Model #	A	B	C	D	Wt	V	TFL \$	HPL \$	Remarks		
 Left with 1 Full / 1 Rec. Legs (Y)	48" Corner, 24" Join Left	3 CEFK 4824 L60 (-)	60	48	24	24	149	10.1			Extended Corners <ul style="list-style-type: none"> Includes top, 2 modesty panels (full or wall access depending on model), corner leg, keyboard tray & single-arm articulating KB mechanism, and 2 end panels Keyboard tray on retractable OE 1000 KA mechanism see page 6-31 Must add "Y" or "Z" end panels (end panels are non-handed) Includes two grommets: one in corner and one at extended end Corner leg is hollow to permit use as wire management conduit Recessed end panels are 11"D See page 1-19 to view modesty options 		
			3 CEFK 4824 L66 (-)	66	48	24	24	156	11.1				
		3 CEFK 4824 L72 (-)	72	48	24	24	164	12.0					
 Right with 2 Recessed Legs (Z)	48" Corner, 24" Join Right	3 CEFK 4824 R60 (-)	60	48	24	24	149	10.1					
		3 CEFK 4824 R66 (-)	66	48	24	24	156	11.1					
		3 CEFK 4824 R72 (-)	72	48	24	24	164	12.0					
Must enter Y or Z to define legs													
EXT'D CORNERS – WALL ACCESS MODESTY													
 Left with 1 Full / 1 Rec. Legs (Y)	48" Corner, 24" Join Left	3 CEPQK 4824 L60 (-)	60	48	24	24	121	10.1				Extended Corner "J" Islands (single post) <ul style="list-style-type: none"> Includes top, modesty panel (partial or wall access depending on model), partial user modesty, keyboard tray & single-arm articulating KB mechanism, solid end panel, end panel with wiring grommet, post leg and hardware Keyboard tray on non-retractable OE 1000 KF mechanism see page 6-31 Includes one grommet Recessed end panels are 11"D See page 1-19 to view modesty options To order Nickel leg add "N" to end of code (add \$105 list) 	
			3 CEPQK 4824 L66 (-)	66	48	24	24	126	11.1				
		3 CEPQK 4824 L72 (-)	72	48	24	24	131	12.0					
 Right with 2 Recessed Legs (Z)	48" Corner, 24" Join Right	3 CEPQK 4824 R60 (-)	60	48	24	24	121	10.1					
		3 CEPQK 4824 R66 (-)	66	48	24	24	126	11.1					
		3 CEPQK 4824 R72 (-)	72	48	24	24	131	12.0					
EXT. "J" – PARTIAL USER/PARTIAL WALL MODESTY													
 Left	48" Corner, 24" Join	3 JCPMK 4824 L72	72	48	24	30	127	12.0			Extended Corner "J" Islands (double post) <ul style="list-style-type: none"> Includes top, modesty panel (partial or wall access depending on model), keyboard tray & single-arm articulating KB mechanism, solid end panel, end panel with wiring grommet, 2 post legs and hardware Keyboard tray on retractable OE 1000 KA mechanism see page 6-31 Includes one grommet Recessed end panels are 11"D See page 1-19 to view modesty options To order Nickel legs add "N" to end of code (add \$210 list) 		
			3 JCPMK 4824 R72	72	48	24	30	127	12.0				
 Right	48" Corner, 24" Join	3 JCPMK 4824 L72	72	48	24	30	127	12.0					
			3 JCPMK 4824 R72	72	48	24	30	127	12.0				
EXT. "J" – PARTIAL USER / HIGH WALL MODESTY													
 Left	48" Corner, 24" Join	3 JCQMK 4824 L72	72	48	24	30	127	12.0				Extended Corner "J" Islands (double post) <ul style="list-style-type: none"> Includes top, modesty panel (partial or wall access depending on model), keyboard tray & single-arm articulating KB mechanism, solid end panel, end panel with wiring grommet, 2 post legs and hardware Keyboard tray on retractable OE 1000 KA mechanism see page 6-31 Includes one grommet Recessed end panels are 11"D See page 1-19 to view modesty options To order Nickel legs add "N" to end of code (add \$210 list) 	
			3 JCQMK 4824 R72	72	48	24	30	127	12.0				
 Right	48" Corner, 24" Join	3 JCQMK 4824 L72	72	48	24	30	127	12.0					
			3 JCQMK 4824 R72	72	48	24	30	127	12.0				
EXTENDED "J" – PARTIAL WALL MODESTY													
 Left	48" Corner, 24" Join	3 JCPDK 4824 L72	72	48	24	30	113	12.0					Extended Corner "J" Islands (double post) <ul style="list-style-type: none"> Includes top, modesty panel (partial or wall access depending on model), keyboard tray & single-arm articulating KB mechanism, solid end panel, end panel with wiring grommet, 2 post legs and hardware Keyboard tray on retractable OE 1000 KA mechanism see page 6-31 Includes one grommet Recessed end panels are 11"D See page 1-19 to view modesty options To order Nickel legs add "N" to end of code (add \$210 list)
			3 JCPDK 4824 R72	72	48	24	30	113	12.0				
 Right	48" Corner, 24" Join	3 JCPDK 4824 L72	72	48	24	30	113	12.0					
			3 JCPDK 4824 R72	72	48	24	30	113	12.0				
EXTENDED "J" – HIGH WALL ACCESS MODESTY													
 Left	48" Corner, 24" Join	3 JCQDK 4824 L72	72	48	24	30	113	12.0			Extended Corner "J" Islands (double post) <ul style="list-style-type: none"> Includes top, modesty panel (partial or wall access depending on model), keyboard tray & single-arm articulating KB mechanism, solid end panel, end panel with wiring grommet, 2 post legs and hardware Keyboard tray on retractable OE 1000 KA mechanism see page 6-31 Includes one grommet Recessed end panels are 11"D See page 1-19 to view modesty options To order Nickel legs add "N" to end of code (add \$210 list) 		
			3 JCQDK 4824 R72	72	48	24	30	113	12.0				
 Right	48" Corner, 24" Join	3 JCQDK 4824 L72	72	48	24	30	113	12.0					
			3 JCQDK 4824 R72	72	48	24	30	113	12.0				

LEGEND: A=length; B=depth; C=join; D=join (inches); Wt=shipping weight (lbs); V=volume (cubic feet); TFL \$=thermally fused laminate \$; HPL \$= high pressure laminate \$

EXTENDED CORNER "D" – LEFT



tree®

EXTENDED CORNERS "D" (LEFT) – FULL MODESTY

Model #	A	B	C	D	Wt	V	TFL \$	HPL \$
---------	---	---	---	---	----	---	--------	--------

Remarks

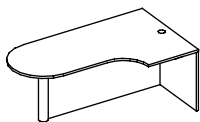

36" Corner, 20" Join	3 DMCF 3620 L48	48	36	20	24	86	7.0	
	3 DMCF 3620 L54	54	36	20	24	93	7.7	
	3 DMCF 3620 L60	60	36	20	24	100	8.4	
	3 DMCF 3620 L66	66	36	20	24	107	9.2	
	3 DMCF 3620 L72	72	36	20	24	113	9.9	

- Includes top, full height user modesty and end panel, post leg and hardware
- 36" Corner units have 24" deep D-Top
- 42" and 48" Corner units have 30" deep D-Top
- To order Nickel leg add "N" to end of code (add \$105 List)

EXTENDED CORNER "D" SIZING LEGEND

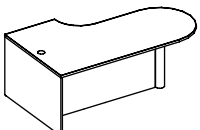
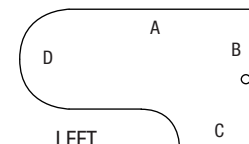

36" Corner, 24" Join	3 DMCF 3624 L54	54	36	24	24	94	7.7	
	3 DMCF 3624 L60	60	36	24	24	101	8.4	
	3 DMCF 3624 L66	66	36	24	24	108	9.2	
	3 DMCF 3624 L72	72	36	24	24	115	9.9	

42" Corner, 24" Join	3 DMCF 4224 L72	72	42	24	30	120	10.2	
	3 DMCF 4224 L84	84	42	24	30	135	11.7	

48" Corner, 24" Join	3 DMCF 4824 L72	72	48	24	30	128	11.5	
	3 DMCF 4824 L84	84	48	24	30	143	13.2	

SIN 711-2

EXTENDED CORNERS "D" (LEFT) – PARTIAL MOD.

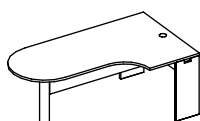

36" Corner, 20" Join	3 DMCP 3620 L48	48	36	20	24	69	7.0	
	3 DMCP 3620 L54	54	36	20	24	74	7.7	
	3 DMCP 3620 L60	60	36	20	24	79	8.4	
	3 DMCP 3620 L66	66	36	20	24	84	9.2	
	3 DMCP 3620 L72	72	36	20	24	89	9.9	

- Includes top, partial height user modesty and end panel, support panel with wiring grommet, post leg and hardware
- 36" Corner units have 24" deep D-Top
- 42" and 48" Corner units have 30" deep D-Top
- To order Nickel leg add "N" to end of code (add \$105 List)

EXTENDED CORNER "D" SIZING LEGEND

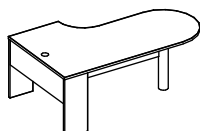
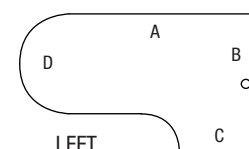

36" Corner, 24" Join	3 DMCP 3624 L54	54	36	24	24	75	7.7	
	3 DMCP 3624 L60	60	36	24	24	80	8.4	
	3 DMCP 3624 L66	66	36	24	24	85	9.2	
	3 DMCP 3624 L72	72	36	24	24	90	9.9	

42" Corner, 24" Join	3 DMCP 4224 L72	72	42	24	30	92	10.2	
	3 DMCP 4224 L84	84	42	24	30	103	11.7	

48" Corner, 24" Join	3 DMCP 4824 L72	72	48	24	30	103	11.5	
	3 DMCP 4824 L84	84	48	24	30	117	13.2	

SIN 711-2

EXTENDED CORNERS "D" (LEFT) – T LEG

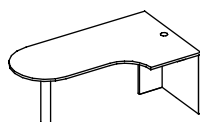

36" Corner, 20" Join	3 DCT 3620 L48	48	36	20	24	86	7.0	
	3 DCT 3620 L54	54	36	20	24	93	7.7	
	3 DCT 3620 L60	60	36	20	24	100	8.4	
	3 DCT 3620 L66	66	36	20	24	107	9.2	
	3 DCT 3620 L72	72	36	20	24	113	9.9	

- Includes top, support panel with wiring grommet and end panel, post leg and hardware
- 36" Corner units have 24" deep D-Top
- 42" and 48" Corner units have 30" deep D-Top
- To order Nickel leg add "N" to end of code (add \$105 List)

EXTENDED CORNER "D" SIZING LEGEND

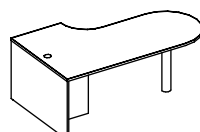
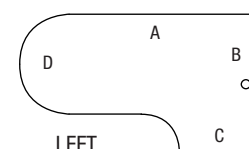

36" Corner, 24" Join	3 DCT 3624 L54	54	36	24	24	94	7.7	
	3 DCT 3624 L60	60	36	24	24	101	8.4	
	3 DCT 3624 L66	66	36	24	24	108	9.2	
	3 DCT 3624 L72	72	36	24	24	115	9.9	

42" Corner, 24" Join	3 DCT 4224 L72	72	42	24	30	120	10.2	
	3 DCT 4224 L84	84	42	24	30	135	11.7	

48" Corner, 24" Join	3 DCT 4824 L72	72	48	24	30	128	11.5	
	3 DCT 4824 L84	84	48	24	30	143	13.2	

SIN 711-2

LEGEND: A=length; B=depth; C=join; D=join (inches); Wt=shipping weight (lbs); V=volume (cubic feet); TFL \$=thermally fused laminate \$; HPL \$= high pressure laminate \$

EXTENDED CORNER "D" – RIGHT



EXTENDED CORNERS "D" (RIGHT) – FULL MODESTY

Model #	A	B	C	D	Wt	V	TFL \$	HPL \$
---------	---	---	---	---	----	---	--------	--------

Remarks

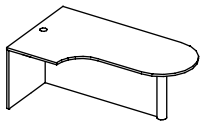

36" Corner, 20" Join

3 DMCF 3620 R48	48	36	20	24	86	7.0		
3 DMCF 3620 R54	54	36	20	24	93	7.7		
3 DMCF 3620 R60	60	36	20	24	100	8.4		
3 DMCF 3620 R66	66	36	20	24	107	9.2		
3 DMCF 3620 R72	72	36	20	24	113	9.9		

- Includes top, full height user modesty and end panel, post leg and hardware
- 36" Corner units have 24" deep D-Top
- 42" and 48" Corner units have 30" deep D-Top
- To order Nickel leg add "N" to end of code (add \$105 List)

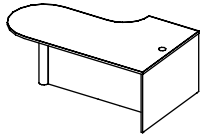

36" Corner, 24" Join

3 DMCF 3624 R54	54	36	24	24	94	7.7		
3 DMCF 3624 R60	60	36	24	24	101	8.4		
3 DMCF 3624 R66	66	36	24	24	108	9.2		
3 DMCF 3624 R72	72	36	24	24	115	9.9		

EXTENDED CORNER "D"
SIZING LEGEND

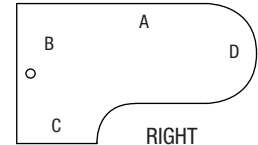

42" Corner, 24" Join

3 DMCF 4224 R72	72	42	24	30	120	10.2		
3 DMCF 4224 R84	84	42	24	30	135	11.7		

48" Corner, 24" Join

3 DMCF 4824 R72	72	48	24	30	128	11.5		
3 DMCF 4824 R84	84	48	24	30	143	13.2		

SIN 711-2

EXTENDED CORNERS "D" (RIGHT) – PARTIAL MOD.

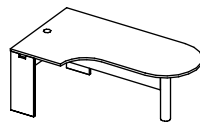

36" Corner, 20" Join

3 DMCP 3620 R48	48	36	20	24	69	7.0		
3 DMCP 3620 R54	54	36	20	24	74	7.7		
3 DMCP 3620 R60	60	36	20	24	79	8.4		
3 DMCP 3620 R66	66	36	20	24	84	9.2		
3 DMCP 3620 R72	72	36	20	24	89	9.9		

- Includes top, partial height user modesty and end panel, support panel with wiring grommet, post leg and hardware
- 36" Corner units have 24" deep D-Top
- 42" and 48" Corner units have 30" deep D-Top
- To order Nickel leg add "N" to end of code (add \$105 List)

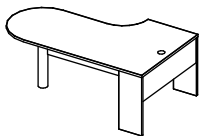

36" Corner, 24" Join

3 DMCP 3624 R54	54	36	24	24	75	7.7		
3 DMCP 3624 R60	60	36	24	24	80	8.4		
3 DMCP 3624 R66	66	36	24	24	85	9.2		
3 DMCP 3624 R72	72	36	24	24	90	9.9		

EXTENDED CORNER "D"
SIZING LEGEND

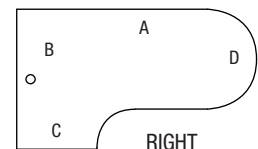

42" Corner, 24" Join

3 DMCP 4224 R72	72	42	24	30	92	10.2		
3 DMCP 4224 R84	84	42	24	30	103	11.7		

48" Corner, 24" Join

3 DMCP 4824 R72	72	48	24	30	103	11.5		
3 DMCP 4824 R84	84	48	24	30	117	13.2		

SIN 711-2

EXTENDED CORNERS "D" (RIGHT) – T LEG

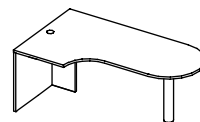

36" Corner, 20" Join

3 DCT 3620 R48	48	36	20	24	86	7.0		
3 DCT 3620 R54	54	36	20	24	93	7.7		
3 DCT 3620 R60	60	36	20	24	100	8.4		
3 DCT 3620 R66	66	36	20	24	107	9.2		
3 DCT 3620 R72	72	36	20	24	113	9.9		

- Includes top, support panel with wiring grommet and end panel, post leg and hardware
- 36" Corner units have 24" deep D-Top
- 42" and 48" Corner units have 30" deep D-Top
- To order Nickel leg add "N" to end of code (add \$105 List)

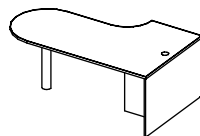

36" Corner, 24" Join

3 DCT 3624 R54	54	36	24	24	94	7.7		
3 DCT 3624 R60	60	36	24	24	101	8.4		
3 DCT 3624 R66	66	36	24	24	108	9.2		
3 DCT 3624 R72	72	36	24	24	115	9.9		

EXTENDED CORNER "D"
SIZING LEGEND

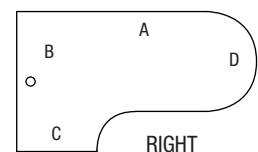

42" Corner, 24" Join

3 DCT 4224 R72	72	42	24	30	120	10.2		
3 DCT 4224 R84	84	42	24	30	135	11.7		

48" Corner, 24" Join

3 DCT 4824 R72	72	48	24	30	128	11.5		
3 DCT 4824 R84	84	48	24	30	143	13.2		

SIN 711-2

LEGEND: A=length; B=depth; C=join; D=join (inches); Wt=shipping weight (lbs); V=volume (cubic feet); TFL \$=thermally fused laminate \$; HPL \$= high pressure laminate \$

PEDESTALS



MOBILE PEDESTALS		Model #	W	D	H	Wt	V	TFL \$	HPL \$	Remarks		
<p>SIN 711-2</p>	Box / File	3 SMW 20 (-)	16	20	22	56	4.0			<ul style="list-style-type: none"> • Can specify up to 3 finishes (Contrast – drawer faces, Base-body, Top-top) – drawer faces or top or both can be HP laminate. • HPL price includes HP on Tops (T) or Faces (C) (specify which). If both wanted in HP, add \$78 List, (\$100 List for legal width peds). • Can be keyed alike, specify on order • Need to select handle style and finish • Gang lock secures <u>all</u> pedestal drawers • <u>All</u> drawers on <u>full</u> extension, ball bearing slides. • Includes hanging file suspension bars • Accepts legal and letter files. • Includes pencil tray in top “Box” drawer. • Mobile peds have hidden 5th wheel behind bottom face to prevent tipping when bottom and top drawers open at the same time. • 3mm trim on all top and face edges • Mobile peds can be ordered as freestanding by adding “F” to the end of model numbers eg. 3 SMX 20 <u>F</u>. Casters replaced with levellers in factory, price remains the same. • Cushion is attached using Velcro. • Seating fabric is standard in Black. Panel fabrics from INLINE Fabric Card can be used but they do not meet BIFMA seating wear standards. 		
		3 SMW 24 (-)	16	24	22	65	5.0					
		3 SMW 30 (-)	16	29	22	74	6.0					
	Box / Box / File	3 SMX 20 (-)	16	20	27	68	5.0					
		3 SMX 24 (-)	16	24	27	81	7.0					
		3 SMX 30 (-)	16	29	27	94	9.0					
	File / File	3 SMY 20 (-)	16	20	27	67	5.0					
		3 SMY 24 (-)	16	24	27	80	7.0					
		3 SMY 30 (-)	16	29	27	93	9.0					
SEATED PEDESTALS												
<p>SIN 711-2</p>	Box / File	3 SMWS 20 (-)	16	20	23	65	4.0			<ul style="list-style-type: none"> • Explanation of Standard Coding: S → Storage M → Mobile Pedestal H → Hanging Pedestal J → Floor Pedestal W → Box / File WS → Box / File / Seat X → Box / Box / File Y → File / File • Floor pedestal glides have over 1" leveling capacity 		
		3 SMWS 24 (-)	16	24	23	75	5.0					
		<p>Note: Black seating fabric only. C.O.M. at same price.</p>										
HANGING PEDESTALS												
<p>SIN 711-2</p>	Box / File	3 SHW 20 (-)	16	18	18	54	4.0			<ul style="list-style-type: none"> • Choosing a Pedestal 18"D hanging ped fits any top 20"D Pedestals fit under <ul style="list-style-type: none"> • 24"D TF's and TP's • 20"D straight BN's • 24"D straight BF's • all CEF's and CEP's 24"D Pedestals fit under <ul style="list-style-type: none"> • 30"D TF's and TP's • 24"D straight BN's 30"D Floor Pedestals fit under <ul style="list-style-type: none"> • 30"D TF's and TP's (actual depth is 29") • Legal width files hang side-to-side or front-to-back 		
		3 SHW 24 (-)	16	24	18	62	5.0					
FLOOR PEDESTALS												
<p>SIN 711-2</p>	Open / Box / File	3 SJO 20 (-)	16	20	27	59	5.0			<ul style="list-style-type: none"> • Floor pedestal glides have over 1" leveling capacity 		
		3 SJO 24 (-)	16	24	27	70	7.0					
	Box / Box / File	3 SJX 20 (-)	16	20	27	65	5.0					
		3 SJX 24 (-)	16	24	27	78	7.0					
		3 SJX 30 (-)	16	29	27	99	9.0					
	File / File	3 SJY 20 (-)	16	20	27	64	5.0					
		3 SJY 24 (-)	16	24	27	73	7.0					
		3 SJY 30 (-)	16	29	27	98	9.0					
	Tops To Make Peds Free Standing	3 BN 1620	16	20	1	8	1.0					
		3 BN 1624	16	24	1	10	1.1					
3 BN 1630		16	29	1	12	1.2						
LEGAL WIDTH MOBILE PEDESTALS												
<p>SIN 711-2</p>	Box / File	3 SMW 2020 (-)	19	20	22	75	7.0			<ul style="list-style-type: none"> • Legal width files hang side-to-side or front-to-back 		
		3 SMW 2024 (-)	19	24	22	96	8.3					
		3 SMW 2030 (-)	19	29	22	117	10.2					
	Box / Box / File	3 SMX 2020 (-)	19	20	27	98	8.4					
		3 SMX 2024 (-)	19	24	27	110	9.9					
		3 SMX 2030 (-)	19	29	27	131	12.2					
	File / File	3 SMY 2020 (-)	19	20	27	98	8.4					
		3 SMY 2024 (-)	19	24	27	110	9.9					
		3 SMY 2030 (-)	19	29	27	131	12.2					
			<p style="text-align: center;">↑ Enter Handle Selection to complete code</p>									

LEGEND: W=width; D=depth; H=height (inches); Wt=shipping weight (lbs); V=volume (cubic feet); TFL \$=thermally fused laminate \$; HPL \$= high pressure laminate \$

LATERAL FILE / STORAGE UNITS



MULTIFILE		Model #	W	D	H	Wt	V	TFL \$	HPL \$ TOP ONLY	HPL \$ TOP & FRONT	Remarks		
<p>SIN 711-3</p>	Under Desk	3 SMU 3020 (-)	30	20	27.5	110	10.3				<p>See pg. 1-3 for specifying finishes</p> <p>Multifile</p> <ul style="list-style-type: none"> Lateral drawer accepts legal files side-to-side For 2 rows letter files front-to-back order (1) SLFB @ \$20 List Lock secures lateral file and both box drawers Lock Kit available for other file drawer; order – MFLK – \$58 List (installed) <p>Multifile / Storage</p> <ul style="list-style-type: none"> Cupboard has an adjustable shelf Ped gang-locks, cupboard has own lock <p>Lateral / Open Storage</p> <ul style="list-style-type: none"> Internal shelf 12 1/4" clear height. <p>Lateral Files</p> <ul style="list-style-type: none"> Full extension, heavy-duty ball-bearing slides Anti-tip locking system allows only one drawer open at a time All drawer-bottoms reinforced with steel Gang-lock included 5 High unit has fixed storage shelf at top with locking flipper door <p>Filing configurations:</p> <ul style="list-style-type: none"> Standard configuration is for legal hanging folders, side-to-side only. For letter size filing side-to-side on 36"W file drawers only, order (1) SLSS 36 @ \$45 List for each drawer required <p>For front-to-back filing on:</p> <ul style="list-style-type: none"> 30"W files: for 2 rows of letter files order (1) SLFB @ \$20 List/drawer 36"W files: for 2 rows of legal files front-to-back; or 2 rows of letter files front-to-back, order (1) SLFB @ \$20 List per drawer 44"W files: for 2 rows of legal files front-to-back, order (1) SLFB @ \$20 List; for 3 rows of letter files front-to-back, order (2) SLFB @ \$20 List/each pair/drawer <p>All units shipped assembled</p> <div style="border: 1px solid black; padding: 5px;"> <p>4 Handles to choose from:</p> <p>K1 Black, Tear Drop</p> <p>K2 Black, Wire</p> <p>N1 Nickel, Tear Drop</p> <p>N2 Nickel, Wire</p> </div>		
			3 SMU 3024 (-)	30	24	27.5	115	10.3					
	Freestanding	3 SMF 3020 (-)	30	20	28.5	125	10.9						
		3 SMF 3024 (-)	30	24	28.5	130	10.9						
Lock on small File Drawer MFLK :													
MULTIFILE / STORAGE		Model #	W	D	H	Wt	V	TFL \$	HPL \$ TOP ONLY	HPL \$ TOP & FRONT		Remarks	
<p>SIN 711-3</p>	Under Desk	3 SMCU 3020 (-)	30	20	27.5	110	10.3					<p>Multifile / Storage</p> <ul style="list-style-type: none"> Cupboard has an adjustable shelf Ped gang-locks, cupboard has own lock <p>Lateral / Open Storage</p> <ul style="list-style-type: none"> Internal shelf 12 1/4" clear height. <p>Lateral Files</p> <ul style="list-style-type: none"> Full extension, heavy-duty ball-bearing slides Anti-tip locking system allows only one drawer open at a time All drawer-bottoms reinforced with steel Gang-lock included 5 High unit has fixed storage shelf at top with locking flipper door <p>Filing configurations:</p> <ul style="list-style-type: none"> Standard configuration is for legal hanging folders, side-to-side only. For letter size filing side-to-side on 36"W file drawers only, order (1) SLSS 36 @ \$45 List for each drawer required <p>For front-to-back filing on:</p> <ul style="list-style-type: none"> 30"W files: for 2 rows of letter files order (1) SLFB @ \$20 List/drawer 36"W files: for 2 rows of legal files front-to-back; or 2 rows of letter files front-to-back, order (1) SLFB @ \$20 List per drawer 44"W files: for 2 rows of legal files front-to-back, order (1) SLFB @ \$20 List; for 3 rows of letter files front-to-back, order (2) SLFB @ \$20 List/each pair/drawer <p>All units shipped assembled</p> <div style="border: 1px solid black; padding: 5px;"> <p>4 Handles to choose from:</p> <p>K1 Black, Tear Drop</p> <p>K2 Black, Wire</p> <p>N1 Nickel, Tear Drop</p> <p>N2 Nickel, Wire</p> </div>	
		3 SMCU 3024 (-)	30	24	27.5	115	10.3						
	Freestanding	3 SMCF 3020 (-)	30	20	28.5	125	10.9						
		3 SMCF 3024 (-)	30	24	28.5	130	10.9						
LATERAL / OPEN STORAGE		Model #	W	D	H	Wt	V	TFL \$	HPL \$ TOP ONLY	HPL \$ TOP & FRONT			Remarks
<p>SIN 711-3</p>	Under Desk	3 SMOU 3020 (-)	30	20	27.5	85	10.3						<p>Lateral / Open Storage</p> <ul style="list-style-type: none"> Internal shelf 12 1/4" clear height. <p>Lateral Files</p> <ul style="list-style-type: none"> Full extension, heavy-duty ball-bearing slides Anti-tip locking system allows only one drawer open at a time All drawer-bottoms reinforced with steel Gang-lock included 5 High unit has fixed storage shelf at top with locking flipper door <p>Filing configurations:</p> <ul style="list-style-type: none"> Standard configuration is for legal hanging folders, side-to-side only. For letter size filing side-to-side on 36"W file drawers only, order (1) SLSS 36 @ \$45 List for each drawer required <p>For front-to-back filing on:</p> <ul style="list-style-type: none"> 30"W files: for 2 rows of letter files order (1) SLFB @ \$20 List/drawer 36"W files: for 2 rows of legal files front-to-back; or 2 rows of letter files front-to-back, order (1) SLFB @ \$20 List per drawer 44"W files: for 2 rows of legal files front-to-back, order (1) SLFB @ \$20 List; for 3 rows of letter files front-to-back, order (2) SLFB @ \$20 List/each pair/drawer <p>All units shipped assembled</p> <div style="border: 1px solid black; padding: 5px;"> <p>4 Handles to choose from:</p> <p>K1 Black, Tear Drop</p> <p>K2 Black, Wire</p> <p>N1 Nickel, Tear Drop</p> <p>N2 Nickel, Wire</p> </div>
		3 SMOU 3620 (-)	36	20	27.5	107	12.0						
	Freestanding	3 SMOF 3020 (-)	30	20	28.5	100	10.9						
		3 SMOF 3024 (-)	30	24	28.5	110	10.9						
		3 SMOF 3620 (-)	36	20	28.5	127	12.0						
		3 SMOF 3624 (-)	36	24	28.5	136	13.8						
LATERAL / BOX DRAWERS		Model #	W	D	H	Wt	V	TFL \$	HPL \$ TOP ONLY	HPL \$ TOP & FRONT	Remarks		
<p>SIN 711-3</p>	Under Desk	3 SMBU 3020 (-)	30	20	27.5	110	10.3				<p>Lateral / Open Storage</p> <ul style="list-style-type: none"> Internal shelf 12 1/4" clear height. <p>Lateral Files</p> <ul style="list-style-type: none"> Full extension, heavy-duty ball-bearing slides Anti-tip locking system allows only one drawer open at a time All drawer-bottoms reinforced with steel Gang-lock included 5 High unit has fixed storage shelf at top with locking flipper door <p>Filing configurations:</p> <ul style="list-style-type: none"> Standard configuration is for legal hanging folders, side-to-side only. For letter size filing side-to-side on 36"W file drawers only, order (1) SLSS 36 @ \$45 List for each drawer required <p>For front-to-back filing on:</p> <ul style="list-style-type: none"> 30"W files: for 2 rows of letter files order (1) SLFB @ \$20 List/drawer 36"W files: for 2 rows of legal files front-to-back; or 2 rows of letter files front-to-back, order (1) SLFB @ \$20 List per drawer 44"W files: for 2 rows of legal files front-to-back, order (1) SLFB @ \$20 List; for 3 rows of letter files front-to-back, order (2) SLFB @ \$20 List/each pair/drawer <p>All units shipped assembled</p> <div style="border: 1px solid black; padding: 5px;"> <p>4 Handles to choose from:</p> <p>K1 Black, Tear Drop</p> <p>K2 Black, Wire</p> <p>N1 Nickel, Tear Drop</p> <p>N2 Nickel, Wire</p> </div>		
		3 SMBU 3024 (-)	30	24	27.5	115	10.3						
	Freestanding	3 SMBF 3020 (-)	30	20	28.5	125	10.9						
		3 SMBF 3024 (-)	30	24	28.5	130	10.9						
	LATERAL FILE		Model #	W	D	H	Wt	V	TFL \$	HPL \$ TOP ONLY		HPL \$ TOP & FRONT	
	<p>SIN 711-3</p>	Under Desk	3 SLU 3020 (-)	30	20	27.5	108	10.3					<p>Lateral / Open Storage</p> <ul style="list-style-type: none"> Internal shelf 12 1/4" clear height. <p>Lateral Files</p> <ul style="list-style-type: none"> Full extension, heavy-duty ball-bearing slides Anti-tip locking system allows only one drawer open at a time All drawer-bottoms reinforced with steel Gang-lock included 5 High unit has fixed storage shelf at top with locking flipper door <p>Filing configurations:</p> <ul style="list-style-type: none"> Standard configuration is for legal hanging folders, side-to-side only. For letter size filing side-to-side on 36"W file drawers only, order (1) SLSS 36 @ \$45 List for each drawer required <p>For front-to-back filing on:</p> <ul style="list-style-type: none"> 30"W files: for 2 rows of letter files order (1) SLFB @ \$20 List/drawer 36"W files: for 2 rows of legal files front-to-back; or 2 rows of letter files front-to-back, order (1) SLFB @ \$20 List per drawer 44"W files: for 2 rows of legal files front-to-back, order (1) SLFB @ \$20 List; for 3 rows of letter files front-to-back, order (2) SLFB @ \$20 List/each pair/drawer <p>All units shipped assembled</p> <div style="border: 1px solid black; padding: 5px;"> <p>4 Handles to choose from:</p> <p>K1 Black, Tear Drop</p> <p>K2 Black, Wire</p> <p>N1 Nickel, Tear Drop</p> <p>N2 Nickel, Wire</p> </div>
			3 SLU 3620 (-)	36	20	27.5	130	12.0					
			3 SLU 4420 (-)	44	20	27.5	159	18.8					
			3 SLU 3024 (-)	30	24	27.5	114	10.3					
Freestanding		2 Drawer Lateral	3 SLF 3020 (-)	30	20	28.5	123	10.3					
			3 SLF 3620 (-)	36	20	28.5	150	12.0					
			3 SLF 4420 (-)	44	20	28.5	181	18.8					
			3 SLF 3024 (-)	30	24	28.5	133	10.3					
			3 SLF 3624 (-)	36	24	28.5	159	13.8					
			3 SLF 4424 (-)	44	24	28.5	195	18.8					
			3 Drawer Lateral	3 SLX 3020 (-)	30	20	42	174	17.9				
			3 SLX 3620 (-)	36	20	42	208	19.0					
	3 SLX 3624 (-)	36	24	42	242	20.3							
TALL FILING UNITS		Model #	W	D	H	Wt	V	TFL \$	HPL \$ TOP ONLY	HPL \$ TOP & FRONT	Remarks		
<p>SIN 711-3</p>	4 Drawer Lateral	3 SLY 3020 (-)	30	20	56	230	22.0				<p>Lateral / Open Storage</p> <ul style="list-style-type: none"> Internal shelf 12 1/4" clear height. <p>Lateral Files</p> <ul style="list-style-type: none"> Full extension, heavy-duty ball-bearing slides Anti-tip locking system allows only one drawer open at a time All drawer-bottoms reinforced with steel Gang-lock included 5 High unit has fixed storage shelf at top with locking flipper door <p>Filing configurations:</p> <ul style="list-style-type: none"> Standard configuration is for legal hanging folders, side-to-side only. For letter size filing side-to-side on 36"W file drawers only, order (1) SLSS 36 @ \$45 List for each drawer required <p>For front-to-back filing on:</p> <ul style="list-style-type: none"> 30"W files: for 2 rows of letter files order (1) SLFB @ \$20 List/drawer 36"W files: for 2 rows of legal files front-to-back; or 2 rows of letter files front-to-back, order (1) SLFB @ \$20 List per drawer 44"W files: for 2 rows of legal files front-to-back, order (1) SLFB @ \$20 List; for 3 rows of letter files front-to-back, order (2) SLFB @ \$20 List/each pair/drawer <p>All units shipped assembled</p> <div style="border: 1px solid black; padding: 5px;"> <p>4 Handles to choose from:</p> <p>K1 Black, Tear Drop</p> <p>K2 Black, Wire</p> <p>N1 Nickel, Tear Drop</p> <p>N2 Nickel, Wire</p> </div>		
			3 SLY 3620 (-)	36	20	56	276	26.0					
	4 Drawer Lateral plus Storage	3 SLZ 3020 (-)	30	20	71	254	28.0						
		3 SLZ 3620 (-)	36	20	71	304	33.0						
<div style="border: 1px solid black; padding: 5px; display: inline-block;"> Enter Handle Selection to complete code </div>													

LEGEND: W=width; D=depth; H=height (inches); Wt=shipping weight (lbs); V=volume (cubic feet); TFL \$=thermally fused laminate \$; HPL \$= high pressure laminate \$

TALL LATERAL / STORAGE UNITS

TALL LATERAL / STORAGE WITH REAR WARDROBE



L (Left)



R (Right)

All items SIN 711-3

Model #	W	D	H	Wt	V	TFL \$	HPL \$
---------	---	---	---	----	---	--------	--------

3 SIF 2454 L (-)	24	24	54	201	18.8		
3 SIF 2465 L (-)	24	24	65	223	24.0		
3 SIF 2472 L (-)	24	24	72	240	26.4		
3 SIF 2454 R (-)	24	24	54	201	18.8		
3 SIF 2465 R (-)	24	24	65	223	24.0		
3 SIF 2472 R (-)	24	24	72	240	26.4		

Tall Lateral / Storage (with Rear Wardrobe)

Includes:

- Gang lock on lateral file drawers
- Lock on non-handed storage door
- 2 adjustable shelves (54"H have one shelf only)
- Rear wardrobe is 4.8" wide
- Accepts legal hanging folders side-to-side only

TALL FILING & STORAGE UNITS

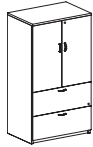

1/2 Storage 1/2 Lateral

3 SPF 362054 (-)	36	20	54	212	25.0		
3 SPF 362454 (-)	36	24	54	227	29.0		
3 SPF 362065 (-)	36	20	65	250	30.0		
3 SPF 362465 (-)	36	24	65	270	36.0		
3 SPF 362072 (-)	36	20	72	268	33.0		
3 SPF 362472 (-)	36	24	72	289	40.0		
3 SPF 362479 (-)	36	24	79	300	42.0		



Open Storage 1/2 Lateral

3 SPFO 362054 (-)	36	20	54	202	25.0		
3 SPFO 362454 (-)	36	24	54	217	29.0		
3 SPFO 362065 (-)	36	20	65	240	30.0		
3 SPFO 362465 (-)	36	24	65	260	36.0		
3 SPFO 362072 (-)	36	20	72	255	33.0		
3 SPFO 362472 (-)	36	24	72	276	40.0		



1/2 & 1/2 with 3 Drawer Lateral File

3 SPFT 362065 (-)	36	20	65	275	30.0		
3 SPFT 362465 (-)	36	24	65	295	36.0		
3 SPFT 362072 (-)	36	20	72	293	33.0		
3 SPFT 362472 (-)	36	24	72	314	40.0		
3 SPFT 362479 (-)	36	24	79	325	42.0		

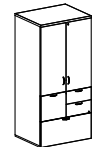

1/2 Storage 1/2 Multifile

3 SPFM 302065 (-)	30	20	65	236	25.0		
3 SPFM 302465 (-)	30	24	65	256	29.6		
3 SPFM 302072 (-)	30	20	72	252	27.5		
3 SPFM 302472 (-)	30	24	72	273	32.7		

All items SIN 711-3

Tall Filing & Storage

- HPL finishes are not available on "Top" surfaces of Tall Filing and Storage units

1/2 Storage, 1/2 Lateral

- Locking storage area with 2 adjustable 1" shelves
- No doors on open version
- 2 locking lateral file drawers

1/2 Storage, 1/2 Lateral – 3 drawer

- Locking storage area with adjustable 1" shelf
- 3 locking lateral file drawers
- Lateral drawers accept legal files side-to-side. See "filing configurations" note on pg. 1-29

1/2 Storage, 1/2 Multifile

- Lock Kit available for other file drawer; order – **MFLK** – \$58 List (installed)

Note: all 3SPF, 3SPFO & 3SPFT models available 30"W.

Change model number to "30" eg. 3SPF362065 becomes 3SPF302065, reduce price of 36"W model by \$25 List.

- Lock Kit available for wardrobe door; order – **HDLK1** – \$58 List (installed)

LATERAL / WARDROBE TOWER

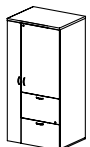

L (Left)

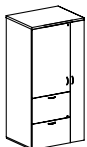

R (Right)

24" Lateral/6" Wardrobe (single door)

3 SPFX 302465 L (-)	30	24	65	284	34.0		
3 SPFX 302472 L (-)	30	24	72	303	37.6		
3 SPFX 302465 R (-)	30	24	65	284	34.0		
3 SPFX 302472 R (-)	30	24	72	303	37.6		

30" Lateral/6" Wardrobe (double door)

3 SPFX 362465 L (-)	36	24	65	298	40.2		
3 SPFX 362472 L (-)	36	24	72	319	44.5		
3 SPFX 362465 R (-)	36	24	65	298	40.2		
3 SPFX 362472 R (-)	36	24	72	319	44.5		

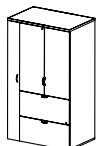

L (Left)

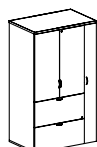

R (Right)

36" Lateral/6" Wardrobe (double door)

3 SPFX 422465 L (-)	42	24	65	312	46.4		
3 SPFX 422472 L (-)	42	24	72	335	51.3		
3 SPFX 422465 R (-)	42	24	65	312	46.4		
3 SPFX 422472 R (-)	42	24	72	335	51.3		

All items SIN 711-3



Enter Handle Selection to complete code

4 Handles to choose from:

- K1 Black, Tear Drop
- K2 Black, Wire
- N1 Nickel, Tear Drop
- N2 Nickel, Wire

LEGEND: W=width; D=depth; H=height (inches); Wt=shipping weight (lbs); V=volume (cubic feet); TFL \$=thermally fused laminate \$; HPL \$= high pressure laminate \$

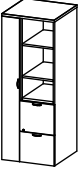
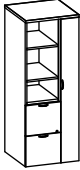
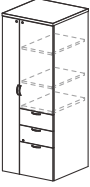
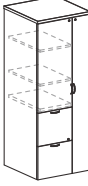
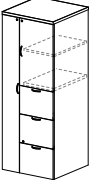
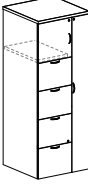
TALL MULTI-STORAGE UNITS

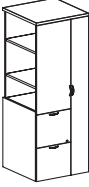
MULTI-STORAGE, OPEN SHELF		Model #	W	D	H	Wt	V	TFL \$	HPL \$	Remarks	
 L (Left)	 R (Right)	3 SIM 2448 L (-)	24	24	48	171	16.7			<p>Multi-Storage (Open & Door versions) Include:</p> <ul style="list-style-type: none"> • Full extension, ball bearing slides • Gang lock on all drawers • Lock on upper storage door • SIMB, SIMD, SIMX and SIMY units also have wardrobe lock • 2 adjustable shelves in upper area • 48"H & 54"H versions have 1 adjustable shelf only • SIMX models have one adjustable shelf in upper area of 65"H and 72"H models only • SIMY models have one adjustable shelf in upper area of 72"H models only • Shipped assembled <p>For all items on page</p> <ul style="list-style-type: none"> • Can specify up to 3 finishes (Contrast – doors, Base – body, Top – top) – HPL option is for doors only • Need to select handle style and finish <ul style="list-style-type: none"> • Black (K) or Nickel (N) • Tear Drop (1) or Wire (2) • eg. for Black Tear Drop handles, add K1 to end of code • Lock Kit available for wardrobe door (where not already included); order – HDLK1 – \$58 List (installed) 	
		3 SIM 2454 L (-)	24	24	54	191	18.8				
	3 SIM 2465 L (-)	24	24	65	210	24.0					
	3 SIM 2472 L (-)	24	24	72	226	26.4					
	3 SIM 2448 R (-)	24	24	48	171	16.7					
	3 SIM 2454 R (-)	24	24	54	191	18.8					
	3 SIM 2465 R (-)	24	24	65	210	24.0					
	3 SIM 2472 R (-)	24	24	72	226	26.4					
<p>SIN 711-3</p>											
MULTI-STORAGE, SHELF & DOOR											
 3 SIMB L (Left)	Box / Box / File	3 SIMB 2448 L (-)	24	24	48	166	16.0				
		3 SIMB 2454 L (-)	24	24	54	201	18.8				
		3 SIMB 2465 L (-)	24	24	65	225	24.0				
		3 SIMB 2472 L (-)	24	24	72	241	26.4				
 3 SIMD R (Right)	File / File	3 SIMD 2448 L (-)	24	24	48	166	16.0				
		3 SIMD 2454 L (-)	24	24	54	201	18.8				
		3 SIMD 2465 L (-)	24	24	65	225	24.0				
		3 SIMD 2472 L (-)	24	24	72	241	26.4				
 3 SIMX L (Left)	File / File / File	3 SIMX 2454 L (-)	24	24	54	217	18.8				
		3 SIMX 2465 L (-)	24	24	65	241	24.0				
		3 SIMX 2472 L (-)	24	24	72	257	26.4				
		3 SIMX 2454 R (-)	24	24	54	217	18.8				
 3 SIMY R (Right)	4-High File	3 SIMY 2465 L (-)	24	24	65	257	24.0				
		3 SIMY 2472 L (-)	24	24	72	273	26.4				
		3 SIMY 2465 R (-)	24	24	65	257	24.0				
		3 SIMY 2472 R (-)	24	24	72	273	26.4				
<p>SIN 711-3</p>											
MULTI-STORAGE WITH SIDE BOOK SHELF											
 L (Left)	File / File	3 SIS 2448 L (-)	24	24	48	161	16.7				
		3 SIS 2454 L (-)	24	24	54	179	18.8				
		3 SIS 2465 L (-)	24	24	65	210	24.0				
		3 SIS 2472 L (-)	24	24	72	226	26.4				
 R (Right)		3 SIS 2448 R (-)	24	24	48	161	16.7				
		3 SIS 2454 R (-)	24	24	54	179	18.8				
		3 SIS 2465 R (-)	24	24	65	210	24.0				
		3 SIS 2472 R (-)	24	24	72	226	26.4				
<p>SIN 711-3</p>											
<p>Multi-Storage (with side bookshelf) Includes:</p> <ul style="list-style-type: none"> • Full extension ball bearing slides • Gang lock for drawers • Shipped assembled • Side wardrobe is 7.1" wide • 48"H and 54"H versions have 1 adjustable shelf only 											
<p>LEGEND: W=width; D=depth; H=height (inches); Wt=shipping weight (lbs); V=volume (cubic feet); TFL \$=thermally fused laminate \$; HPL \$= high pressure laminate \$</p>											

TALL MULTI-STORAGE UNITS

SLIM LINE STORAGE		Model #	W	D	H	Wt	V	TFL \$	HPL \$	Remarks	
<p>SIN 711-3</p>	Box / Box / File	3 SBF 2066 (-)	16	20	66	139	13.4			<p>For all items on page</p> <ul style="list-style-type: none"> • Can specify up to 3 finishes (Top - top, Contrast - doors / drawers, Base - body) – HPL option is for doors only • Need to select handle style and finish • Shipped assembled <p>Filing Versions Include:</p> <ul style="list-style-type: none"> • Full extension, ball bearing slides • Gang lock on all drawers • 2 adjustable shelves in storage area • Locking door installs left or right • SIMB and SIMD units also have wardrobe lock <p>Storage Version Includes:</p> <ul style="list-style-type: none"> • Lock on storage area • 1 fixed shelf and 3 adjustable shelves • Locking door installs left or right <p>Tall Multi-Storage</p> <ul style="list-style-type: none"> • Includes: <ul style="list-style-type: none"> • Full extension ball bearing slides • Gang lock for drawers • 2 adjustable shelves <p>Tall Storage (with Rear Wardrobe)</p> <ul style="list-style-type: none"> • Includes: <ul style="list-style-type: none"> • Lock for storage area • Upper shelves adjustable • One adjustable shelf behind doors <p>Tall Multi-Storage (with Rear Wardrobe)</p> <ul style="list-style-type: none"> • Includes: <ul style="list-style-type: none"> • Gang lock on lateral file drawers • Lock on non-handed storage door • 2 adjustable shelves • Accepts legal hanging folders side-to-side only 	
		3 SBF 2466 (-)	16	24	66	157	16.0				
		3 SBF 2072 (-)	16	20	72	147	15.1				
		3 SBF 2472 (-)	16	24	72	167	18.0				
		File / File	3 SFF 2066 (-)	16	20	66	139	13.4			
		3 SFF 2466 (-)	16	24	66	157	16.0				
		3 SFF 2072 (-)	16	20	72	147	15.1				
		3 SFF 2472 (-)	16	24	72	167	18.0				
		Storage	3 SBS 2066 (-)	16	20	66	94	13.4			
		3 SBS 2466 (-)	16	24	66	114	16.0				
		3 SBS 2072 (-)	16	20	72	147	15.1				
		3 SBS 2472 (-)	16	24	72	167	18.0				

LEGEND: **W**=width; **D**=depth; **H**=height (inches); **Wt**=shipping weight (lbs); **V**=volume (cubic feet); **TFL \$**=thermally fused laminate \$; **HPL \$**= high pressure laminate \$

STORAGE UNITS

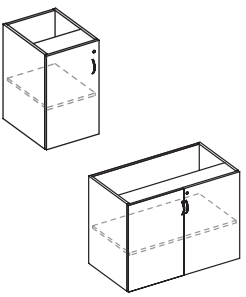
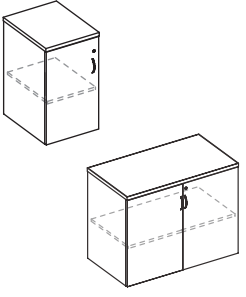
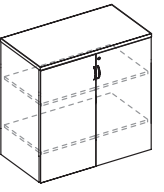
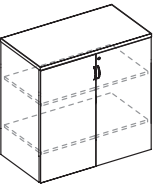
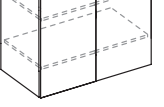
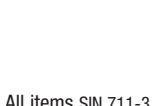

tréo®

STORAGE UNITS	Model #	W	D	H	Wt	V	TFL \$	HPL \$ TOP ONLY	HPL \$ TOP & FRONT	Remarks																																																									
      <p>All items SIN 711-3</p>	Under Desk	3 SSU 1620 (-)	16	20	27.5	64	7.6			<p>Storage</p> <ul style="list-style-type: none"> For Freestanding Storage, can specify up to 3 finishes (Contrast – doors, Base - body, Top - top) – doors or top or both can be HPL Need to select handle style Doors open 110° Desk height units include lock and 1 adjustable shelf Mid-height units include lock and 2 adjustable shelves 48" wide version has shelf fixed at mid-height 16" w and 24" w versions have one door only; hinged on left For 18"D versions, change code to 3 SSF xx18. Price same as equivalent 20"D unit. Shipped assembled For open cabinets, add "0" to code and deduct 20% from list price. eg: 3 SSF 3624 becomes 3 SSFO 3624 <table border="1"> <thead> <tr> <th colspan="3">Extra Shelves</th> </tr> </thead> <tbody> <tr> <td>16"W</td> <td></td> <td>List</td> </tr> <tr> <td>3 SPBSH 1620</td> <td></td> <td>80</td> </tr> <tr> <td>3 SPBSH 1624</td> <td></td> <td>90</td> </tr> <tr> <td>24"W</td> <td></td> <td></td> </tr> <tr> <td>3 SPBSH 2420</td> <td></td> <td>85</td> </tr> <tr> <td>3 SPBSH 2424</td> <td></td> <td>97</td> </tr> <tr> <td>30"W</td> <td></td> <td></td> </tr> <tr> <td>3 SPBSH 3020</td> <td></td> <td>88</td> </tr> <tr> <td>3 SPBSH 3024</td> <td></td> <td>100</td> </tr> <tr> <td>36"W</td> <td></td> <td></td> </tr> <tr> <td>3 SPBSH 3620</td> <td></td> <td>97</td> </tr> <tr> <td>3 SPBSH 3624</td> <td></td> <td>110</td> </tr> <tr> <td>42"W</td> <td></td> <td></td> </tr> <tr> <td>3 SPBSH 4220</td> <td></td> <td>108</td> </tr> <tr> <td>3 SPBSH 4224</td> <td></td> <td>120</td> </tr> <tr> <td>48"W</td> <td></td> <td></td> </tr> <tr> <td>3 SPBSH 4820</td> <td></td> <td>116</td> </tr> <tr> <td>3 SPBSH 4824</td> <td></td> <td>130</td> </tr> </tbody> </table>	Extra Shelves			16"W		List	3 SPBSH 1620		80	3 SPBSH 1624		90	24"W			3 SPBSH 2420		85	3 SPBSH 2424		97	30"W			3 SPBSH 3020		88	3 SPBSH 3024		100	36"W			3 SPBSH 3620		97	3 SPBSH 3624		110	42"W			3 SPBSH 4220		108	3 SPBSH 4224		120	48"W			3 SPBSH 4820		116	3 SPBSH 4824		130
	Extra Shelves																																																																		
	16"W		List																																																																
	3 SPBSH 1620		80																																																																
	3 SPBSH 1624		90																																																																
	24"W																																																																		
	3 SPBSH 2420		85																																																																
	3 SPBSH 2424		97																																																																
	30"W																																																																		
	3 SPBSH 3020		88																																																																
	3 SPBSH 3024		100																																																																
	36"W																																																																		
	3 SPBSH 3620		97																																																																
	3 SPBSH 3624		110																																																																
	42"W																																																																		
	3 SPBSH 4220		108																																																																
	3 SPBSH 4224		120																																																																
	48"W																																																																		
	3 SPBSH 4820		116																																																																
	3 SPBSH 4824		130																																																																
		3 SSU 2420 (-)	24	20	27.5	81	10.8																																																												
		3 SSU 3020 (-)	30	20	27.5	95	13.2																																																												
		3 SSU 3620 (-)	36	20	27.5	108	15.6																																																												
		3 SSU 4220 (-)	42	20	27.5	121	18.0																																																												
		3 SSU 4820 (-)	48	20	27.5	134	20.4																																																												
		3 SSU 1624 (-)	16	24	27.5	72	8.9																																																												
		3 SSU 2424 (-)	24	24	27.5	92	12.7																																																												
		3 SSU 3024 (-)	30	24	27.5	106	15.5																																																												
		3 SSU 3624 (-)	36	24	27.5	120	18.3																																																												
		3 SSU 4224 (-)	42	24	27.5	135	21.1																																																												
		3 SSU 4824 (-)	48	24	27.5	149	23.9																																																												
	Freestanding (Desk Height)	3 SSF 1620 (-)	16	20	28.5	72	7.8																																																												
		3 SSF 2420 (-)	24	20	28.5	94	11.1																																																												
		3 SSF 3020 (-)	30	20	28.5	110	13.6																																																												
		3 SSF 3620 (-)	36	20	28.5	126	16.1																																																												
		3 SSF 4220 (-)	42	20	28.5	143	18.6																																																												
		3 SSF 4820 (-)	48	20	28.5	159	21.0																																																												
		3 SSF 1624 (-)	16	24	28.5	83	9.2																																																												
		3 SSF 2424 (-)	24	24	28.5	106	13.1																																																												
		3 SSF 3024 (-)	30	24	28.5	125	16.0																																																												
		3 SSF 3624 (-)	36	24	28.5	143	18.9																																																												
		3 SSF 4224 (-)	42	24	28.5	161	21.8																																																												
		3 SSF 4824 (-)	48	24	28.5	179	24.7																																																												
	Freestanding (Mid-Height) 36" High	3 SSF 302436 (-)	30	24	36	139	20.1																																																												
		3 SSF 362436 (-)	36	24	36	161	23.8																																																												
		3 SSF 422436 (-)	42	24	36	184	27.4																																																												
	42" High	3 SSF 302442 (-)	30	24	42	151	23.2																																																												
		3 SSF 362442 (-)	36	24	42	174	27.4																																																												
		3 SSF 422442 (-)	42	24	42	198	31.6																																																												
	48" High	3 SSF 302048 (-)	30	20	48	143	22.4																																																												
		3 SSF 362048 (-)	36	20	48	166	26.5																																																												
		3 SSF 302448 (-)	30	24	48	162	26.3																																																												
		3 SSF 362448 (-)	36	24	48	187	31.1																																																												
	54" High	3 SSF 302054 (-)	30	20	54	154	25.0																																																												
		3 SSF 362054 (-)	36	20	54	177	29.6																																																												
		3 SSF 302454 (-)	30	24	54	173	29.4																																																												
		3 SSF 362454 (-)	36	24	54	200	34.7																																																												

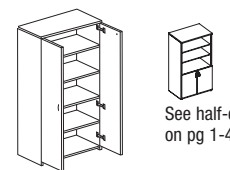
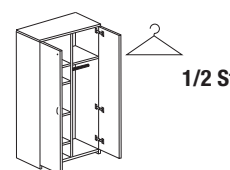
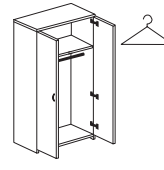
TALL STORAGE	Model #	W	D	H	Wt	V	TFL \$	HPL \$ FRONT	Remarks	
 <p>See half-door models on pg 1-40</p>   <p>All items SIN 711-3</p>	Personal Storage	3 SPB 242065 (-)	24	20	65	145	20.0		<p>Personal Storage</p> <ul style="list-style-type: none"> Locking storage with 1 fixed shelf, 3 adjustable shelves 36" w units have 2 doors 24" w units have 1 door <p>1/2 Storage, 1/2 Wardrobe</p> <ul style="list-style-type: none"> Storage section has locking storage with 1 fixed shelf, 3 adjustable shelves Wardrobe section has 1 fixed shelf and hanger bar <p>Full Wardrobe</p> <ul style="list-style-type: none"> Storage with 1 fixed shelf and hanger bar For 18"D versions of 3 SPB models, change code to 3 SPB xx18xx. Price same as equivalent 20"D unit. Lock Kit available for wardrobe door; order – HDLK1 – \$58 List (installed) 	
		3 SPB 242465 (-)	24	24	65	155	24.0			
		3 SPB 302065 (-)	30	20	65	168	25.0			
		3 SPB 302465 (-)	30	24	65	180	30.0			
		3 SPB 362065 (-)	36	20	65	190	30.0			
		3 SPB 362465 (-)	36	24	65	215	36.0			
		3 SPB 302072 (-)	30	20	72	182	27.1			
		3 SPB 302472 (-)	30	24	72	194	32.3			
		3 SPB 362072 (-)	36	20	72	208	32.8			
		3 SPB 362472 (-)	36	24	72	233	39.1			
		1/2 Storage 1/2 Wardrobe	3 SPS 242448 (-)	24	24	48	143	21.5		
		3 SPS 242454 (-)	24	24	54	153	24.0			
		3 SPS 362465 (-)	36	24	65	240	36.0			
		3 SPS 362472 (-)	36	24	72	259	40.0			
		Full Wardrobe	3 SPW 242448 (-)	24	24	48	124	21.5		
		3 SPW 242454 (-)	24	24	54	135	24.0			
		3 SPW 242465 (-)	24	24	65	155	24.0			
		3 SPW 302465 (-)	30	24	65	198	30.0			
		3 SPW 362465 (-)	36	24	65	240	36.0			
		3 SPW 242472 (-)	24	24	72	173	26.4			
	3 SPW 302472 (-)	30	24	72	216	32.8				
	3 SPW 362472 (-)	36	24	72	259	39.1				

LEGEND: W=width; D=depth; H=height (inches); Wt=shipping weight (lbs); V=volume (cubic feet); TFL \$=thermally fused laminate \$; HPL \$= high pressure laminate \$

TALL STORAGE / BOOKCASES

TALL COMBO STORAGE WITH REAR WARDROBE

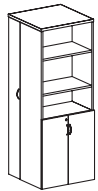

L (Left)



R (Right)

Model #	W	D	H	Wt	V	TFL \$	HPL \$
3 SIB 2065 L (-)	24	20	65	140	22.0		
3 SIB 2465 L (-)	24	24	65	160	24.0		
3 SIB 2472 L (-)	24	24	72	176	26.4		
3 SIB 2065 R (-)	24	20	65	140	22.0		
3 SIB 2465 R (-)	24	24	65	160	24.0		
3 SIB 2472 R (-)	24	24	72	176	26.4		

Enter Handle Selection to complete code

Multi-Storage (with Rear Wardrobe)

Includes:

- Lock for storage area
- One adjustable shelf behind doors
- Shipped assembled
- Rear wardrobe is 7.4" wide on both models

4 Handles to choose from:

- K1 Black, Tear Drop
- K2 Black, Wire
- N1 Nickel, Tear Drop
- N2 Nickel, Wire

BOOKCASES

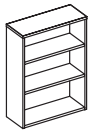

30" Wide, 12" Deep	Model #	W	D	H	Wt	V
29" High	3 SBG 2912	30	12	29	60	2.4
42" High	3 SBG 4212	30	12	42	83	3.4
48" High	3 SBG 4812	30	12	48	90	3.9
54" High	3 SBG 5412	30	12	54	93	4.2
60" High	3 SBG 6012	30	12	60	112	5.8
65" High	3 SBG 6512	30	12	65	117	6.3
72" High	3 SBG 7212	30	12	72	133	6.9
82" High	3 SBG 8212	30	12	82	153	7.5

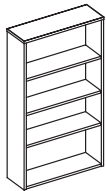

36" Wide, 12" Deep	Model #	W	D	H	Wt	V
29" High	3 SBG 2912	36	12	29	69	4.0
42" High	3 SBG 4212	36	12	42	95	6.0
48" High	3 SBG 4812	36	12	48	102	6.5
54" High	3 SBG 5412	36	12	54	106	6.7
60" High	3 SBG 6012	36	12	60	127	7.0
65" High	3 SBG 6512	36	12	65	133	8.0
72" High	3 SBG 7212	36	12	72	152	9.0
82" High	3 SBG 8212	36	12	82	174	10.0

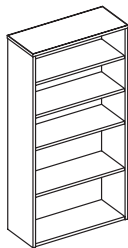

36" Wide, 15" Deep	Model #	W	D	H	Wt	V
29" High	3 SBG 2915	36	15	29	79	4.0
42" High	3 SBG 4215	36	15	42	109	6.0
48" High	3 SBG 4815	36	15	48	118	6.5
54" High	3 SBG 5415	36	15	54	122	6.7
60" High	3 SBG 6015	36	15	60	146	7.0
65" High	3 SBG 6515	36	15	65	159	8.0
72" High	3 SBG 7215	36	15	72	175	9.0
82" High	3 SBG 8215	36	15	82	200	10.0



Optional Shelves	Model #	W	D	H	Wt	V
for 30"W, 12"D	3 SBG SH 11	28	11	1	7	1.0
for 36"W, 12"D	3 SBG SH 11	34	11	1	9	1.5
for 36"W, 15"D	3 SBG SH 14	34	14	1	12	1.8

For all Bookcase items

- Can specify up to 2 finishes
Top – top shelf
Base – sides, back and other shelves

Bookcases

- Includes top and bottom shelf, 2 side panels and back
- Fixed shelf for 60", 65", 72" & 82"H at 28.5"H so two lower rows are both binder height
- Other shelves are adjustable:
 - 29"H – 2 openings
 - 42"H – 3 openings
 - 48"H – 3 openings
 - 60"H – 4 openings
 - 65"H – 4 openings – matches height of most tall storage units
 - 72"H – 5 openings
 - 82"H – 6 openings
- Sides and shelves are 1" thick
- Back is solid 3/4" thick TFL panel
- Shelf depth is 1" less than overall cabinet depth
- Bookcases must be placed against wall for stability

CORNER BOOKCASE

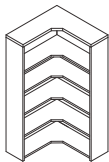

3 SBG 6536	36	36	65	211	11.4
3 SBG 7236	36	36	72	242	13.5

Corner Bookcases

- Includes top and bottom shelf, side and back panels, and one fixed shelf
- Other shelves are adjustable:
 - 65"H has 4 openings
 - 72"H has 5 openings

1/4 ROUND CORNER BOOKCASES

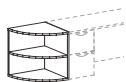

Desk Height	Model #	W	D	H	Wt	V
3 SWM 2028	20	20	29	46	1.8	
3 SWM 2428	24	24	29	53	2.3	
3 SWM 3028	30	30	29	77	3.8	

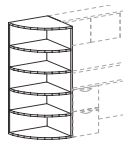

Hutch Height	Model #	W	D	H	Wt	V
3 SWM 2065	20	20	65	92	3.6	
3 SWM 2465	24	24	65	106	4.6	
3 SWM 3065	30	30	65	123	6.5	

All items SIN 711-3

1/4 Round Corner Bookcases

- Includes top, shelves, back panels and hardware
- HPL option is on top panel of desk height unit only
- 28"H version has top, bottom and 1 fixed shelf
- 65"H version has top, bottom and 4 fixed shelves
- All components are 1" thick

LEGEND: W=width; D=depth; H=height (inches); Wt=shipping weight (lbs); V=volume (cubic feet); TFL \$=thermally fused laminate \$; HPL \$= high pressure laminate \$

STORAGE WITH FRAMED TRANSLUCENT DOORS

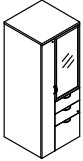
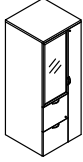
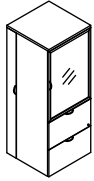
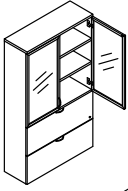
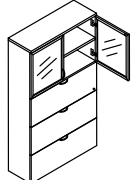
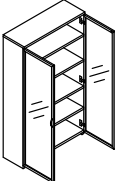
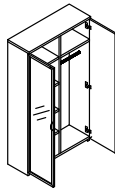
MULTI-STORAGE, SHELF & DOOR		Model #	W	D	H	Wt	V	TFL \$	HPL \$	Remarks
 <p>3 SIMBG L (Left)</p>	3 SIMBG 2454 L (-)	24	24	54	196	18.8				<ul style="list-style-type: none"> • Door frames are anodized aluminium with mitred joints. <p>Multi-storage, Shelf and Door Units</p> <ul style="list-style-type: none"> • Translucent door on storage area only. • HPL applies to wardrobe door and drawer faces only. • 2 adjustable shelves in storage area • Gang lock on all drawers • SIMBG and SIMDG units also have wardrobe lock
	3 SIMBG 2465 L (-)	24	24	65	219	24.0				
	3 SIMBG 2472 L (-)	24	24	72	233	26.4				
	3 SIMBG 2454 R (-)	24	24	54	196	18.8				
	3 SIMBG 2465 R (-)	24	24	65	219	24.0				
	3 SIMBG 2472 R (-)	24	24	72	233	26.4				
 <p>3 SIMDG R (Right)</p>	3 SIMDG 2454 L (-)	24	24	54	196	18.8				
	3 SIMDG 2465 L (-)	24	24	65	219	24.0				
	3 SIMDG 2472 L (-)	24	24	72	233	26.4				
	3 SIMDG 2454 R (-)	24	24	54	196	18.8				
	3 SIMDG 2465 R (-)	24	24	65	219	24.0				
	3 SIMDG 2472 R (-)	24	24	72	233	26.4				
TALL LATERAL/STORAGE WITH REAR WARDROBE										<p>Tall Lateral/Storage with Rear Wardrobe</p> <ul style="list-style-type: none"> • Translucent door on storage area only. • HPL applies to drawer faces only. • 2 adjustable shelves in storage area • Gang lock on lateral file drawers • Rear Wardrobe 4.8" wide • Accepts legal hanging folders side-to-side only
 <p>L (Left)</p>	3 SIFG 2465 L (-)	24	24	65	213	24.0				
	3 SIFG 2472 L (-)	24	24	72	229	26.4				
	3 SIFG 2465 R (-)	24	24	65	213	24.0				
	3 SIFG 2472 R (-)	24	24	72	229	26.4				
TALL FILING & STORAGE UNITS										<p>Tall Filing & Storage Units</p> <ul style="list-style-type: none"> • HPL finishes on lateral drawer fronts only • 2 drawer cabinet has 2 adjustable shelves • 3 drawer cabinet has 1 adjustable shelf • Door and drawer locks are keyed alike
 <p>1/2 Storage 1/2 Lateral</p>	3 SPFG 362065 (-)	36	20	65	235	30.0				
	3 SPFG 362465 (-)	36	24	65	255	36.0				
	3 SPFG 362072 (-)	36	20	72	252	33.0				
	3 SPFG 362472 (-)	36	24	72	273	40.0				
 <p>1/2 and 1/2 with 3 Drawer Lateral File</p> <p>SIN 711-2</p>	3 SPFTG 362065 (-)	36	20	65	266	30.0				
	3 SPFTG 362465 (-)	36	24	65	286	36.0				
	3 SPFTG 362072 (-)	36	20	72	283	33.0				
	3 SPFTG 362472 (-)	36	24	72	304	40.0				
TALL STORAGE										<p>Tall Storage</p> <ul style="list-style-type: none"> • Full storage units have both doors translucent • 1 fixed and 3 adjustable shelves • Locking <p>• 1/2 Storage / 1/2 Wardrobe units have translucent door over storage only. Wardrobe door is solid laminate</p> <ul style="list-style-type: none"> • Only storage door locks • Wardrobe section has one fixed shelf and a hanging bar
 <p>Personal Storage</p>	3 SPBG 362065 (-)	36	20	65	162	30.0				
	3 SPBG 362465 (-)	36	24	65	187	36.0				
	3 SPBG 362472 (-)	36	24	72	203	40.0				
 <p>1/2 Storage 1/2 Wardrobe</p> <p>SIN 711-2</p>	3 SPSG 362465 (-)	36	24	65	226	36.0				
	3 SPSG 362472 (-)	36	24	72	243	40.0				

LEGEND: **W**=width; **D**=depth; **H**=height (inches); **Wt**=shipping weight (lbs); **V**=volume (cubic feet); **TFL \$**=thermally fused laminate \$; **HPL \$**= high pressure laminate \$

HUTCHES / WALL BINS



tréo®

TRANSACTION HUTCH		Model #	W	D	H	Wt	V	TFL \$	HPL \$	Remarks
	14" High	3 HA 3014	30	13	14	36	1.3			Transaction Hutch <ul style="list-style-type: none"> • 13" clearance to desk • All hutches adhere to desk tops with double-sided tape
	13" Deep	3 HA 3614	36	13	14	40	1.3			
		3 HA 4214	42	13	14	46	1.4			
		3 HA 4814	48	13	14	52	1.6			
		3 HA 5414	54	13	14	58	1.6			
		3 HA 6014	60	13	14	62	1.6			
		3 HA 6614	66	13	14	66	1.8			
		3 HA 7214	72	13	14	70	1.8			
		3 HA 7814	78	13	14	74	2.0			
	3 HA 8414	84	13	14	78	2.0				
CORNER TRANSACTION HUTCH		Model #	W	D	H	Wt	V	TFL \$	HPL \$	Remarks
	36" Corner	3 HCA 3614	36	13	14	43	3.7			Corner Transaction Hutch <ul style="list-style-type: none"> • 13" clearance under counter • 2 piece top
	42" Corner	3 HCA 4214	42	13	14	52	4.8			
	48" Corner	3 HCA 4814	48	13	14	63	5.9			
OPEN WALL BINS		Model #	W	D	H	Wt	V	TFL \$	HPL \$	Remarks
	14" High	3 HW T 3614	36	13	14	57	2.1			tréo® Wall Bins <ul style="list-style-type: none"> • Interior 12"D • Shipped RTA • Can specify up to 3 finishes with order (Contrast – doors, if applicable, Base – sides and back, Top – top) • HPL option available for door faces only • Wall mounting components provided • Installer's responsibility to properly secure hanging strip to wall (see below) • Tackboard wall mount requires purchase of FWKIT at \$21 List. See page 1-37 • For full width and fuller height tackboard coverage under wall bins, 25"H tackboards can be purchased from the Boardwalk line, see page 3-35 • Interior height (open bin) 12" • Non-locking is standard for Cupboard Door Wall Bins • Interior height 12" Locking Option – specify: 2 doors – HDLK2 – \$87 List 3 doors – HDLK3 – \$133 List 4 doors – HDLK4 – \$144 List • Flipper door bins come locking as standard • Interior height 12"
	13" Deep	3 HW T 4214	42	13	14	65	2.3			
		3 HW T 4814	48	13	14	74	2.6			
		3 HW T 5414	54	13	14	76	2.8			
		3 HW T 6014	60	13	14	85	3.1			
		3 HW T 6614	66	13	14	93	3.5			
		3 HW T 7214	72	13	14	102	3.7			
CUPBOARD DOOR WALL BINS		Model #	W	D	H	Wt	V	TFL \$	HPL \$	Remarks
	2 Doors	3 HD W 3016	30	13	16	53	2.8			
	30" - 42"	3 HD W 3616	36	13	16	63	3.4			
		3 HD W 4216	42	13	16	72	3.9			
	3 Doors	3 HD W 4816	48	13	16	81	4.4			
	48" - 54"	3 HD W 5416	54	13	16	84	4.7			
	4 Doors	3 HD W 6016	60	13	16	94	5.2			
	60" - 72"	3 HD W 6616	66	13	16	102	5.6			
		3 HD W 7216	72	13	16	111	6.1			
FLIPPER DOOR WALL BINS		Model #	W	D	H	Wt	V	TFL \$	HPL \$	Remarks
	1 Door	3 HF W 3014	30	14	14	53	2.8			
		3 HF W 3614	36	14	14	63	3.4			
		3 HF W 4214	42	14	14	72	3.9			
		3 HF W 4814	48	14	14	81	4.4			
	2 Doors	3 HF W 5414	54	14	14	84	4.7			
		3 HF W 6014	60	14	14	94	5.2			
		3 HF W 6614	66	14	14	102	5.6			
		3 HF W 7214	72	14	14	111	6.1			

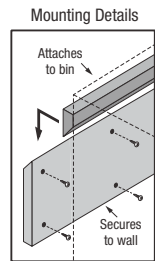

All Items
SIN 711-2

LEGEND: W=width; D=depth; H=height (inches); Wt=shipping weight (lbs); V=volume (cubic feet); TFL \$=thermally fused laminate \$; HPL \$= high pressure laminate \$

HUTCHES

OPEN HUTCH WITH TOP		Model #	W	D	H	Wt	V	TFL \$	HPL \$	Remarks
<p>SIN 711-2</p>	36" High 13" Deep	3 HH T 2436	24	13	36	59	2.6			36"H Open Hutch <ul style="list-style-type: none"> Height matches 65"H storage 22" clearance under shelf; 19" under valance Full width wire access strip at bottom Task light wire grommet in back panel Shipped RTA Tack Boards (see page 1-37) Shelves and uprights are 1" material, back is 3/4" thick Top panel adds 1" to overall depth of open hutches Interior height 12"
		3 HH T 3036	30	13	36	67	3.0			
		3 HH T 3636	36	13	36	75	3.4			
		3 HH T 4236	42	13	36	85	4.2			
		3 HH T 4836	48	13	36	96	5.1			
		3 HH T 5436	54	13	36	105	6.0			
		3 HH T 6036	60	13	36	114	7.3			
		3 HH T 6636	66	13	36	123	8.6			
		3 HH T 7236	72	13	36	132	10.0			
		3 HH T 7836	78	13	36	141	11.4			
3 HH T 8436	84	13	36	150	12.8					
<p>SIN 711-2</p>	43" High 13" Deep	3 HH T 3043	30	13	43	73	3.8			43"H Open Hutch <ul style="list-style-type: none"> Height matches 72"H storage As above except clearance under shelf is 27 3/4" Interior height 13"
		3 HH T 3643	36	13	43	82	4.2			
		3 HH T 4243	42	13	43	93	5.0			
		3 HH T 4843	48	13	43	105	5.9			
		3 HH T 5443	54	13	43	115	6.8			
		3 HH T 6043	60	13	43	125	8.1			
		3 HH T 6643	66	13	43	135	9.4			
		3 HH T 7243	72	13	43	145	10.8			
		3 HH T 7843	78	13	43	155	12.2			
		3 HH T 8443	84	13	43	166	13.6			
CUPBOARD DOOR HUTCH										
	36" H 2 Doors 24" - 42"	3 HD 2436	24	13	36	75	3.0			36"H Cupboard Door Hutches <ul style="list-style-type: none"> Height matches 65"H storage Doors / top panel add 1" to overall depth of Cupboard Door Hutches Interior 12"D and 12"H 20" clear under doors; 22" under shelf Full width wire access strip at bottom Task light wire grommet in back panel Hinges open 110° Can specify up to 3 finishes with order (Contrast – doors, Base - sides and back, Top - top) HPL option available for door faces only Non-locking is standard Locking Option – specify: <ul style="list-style-type: none"> 2 doors – HDLK2 - \$87 List 3 doors – HDLK3 - \$133 List 4 doors – HDLK4 - \$144 List
		3 HD 3036	30	13	36	79	3.0			
		3 HD 3636	36	13	36	88	3.6			
		3 HD 4236	42	13	36	94	5.2			
		3 HD 4836	48	13	36	102	6.5			
		3 HD 5436	54	13	36	110	7.6			
		3 HD 6036	60	13	36	124	8.4			
		3 HD 6636	66	13	36	138	9.2			
		3 HD 7236	72	13	36	153	10.0			
		3 HD 7836	78	13	36	168	10.7			
3 HD 8436	84	13	36	183	11.7					
	43" H 2 Doors 24" - 42"	3 HD 2443	24	13	43	81	3.8			
		3 HD 3043	30	13	43	86	3.8			
		3 HD 3643	36	13	43	96	4.4			
		3 HD 4243	42	13	43	103	6.0			
		3 HD 4843	48	13	43	112	7.3			
		3 HD 5443	54	13	43	121	8.4			
		3 HD 6043	60	13	43	136	9.2			
		3 HD 6643	66	13	43	151	10.0			
		3 HD 7243	72	13	43	167	10.8			
		3 HD 7843	78	13	43	183	11.5			
3 HD 8443	84	13	43	199	12.5					
<p>SIN 711-2</p>	43" H 3 Doors 48" - 54"	3 HD 4843	48	13	43	112	7.3			43"H Cupboard Door Hutches <ul style="list-style-type: none"> Height matches 72"H storage As above except clearance under doors is 25 3/4" and under shelf is 27 3/4" Interior height 13"
		3 HD 5443	54	13	43	121	8.4			
		3 HD 6043	60	13	43	136	9.2			
		3 HD 6643	66	13	43	151	10.0			
		3 HD 7243	72	13	43	167	10.8			
		3 HD 7843	78	13	43	183	11.5			
		3 HD 8443	84	13	43	199	12.5			

Horizontal Paper Management slots available on page 1-38



Note: all 42"H hutch models have been altered to 43"H (with new model numbers) to match the height of 72"H freestanding storage units. 42"H models can still be ordered at same price as like sized 43"H units.

Horizontal Paper Management slots available on page 1-38

LEGEND: W=width; D=depth; H=height (inches); Wt=shipping weight (lbs); V=volume (cubic feet); TFL \$=thermally fused laminate \$; HPL \$= high pressure laminate \$

FLIPPER DOOR HUTCHES

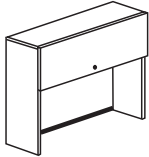
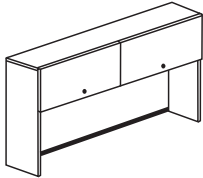
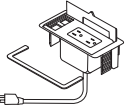
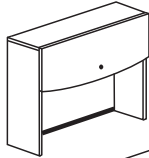
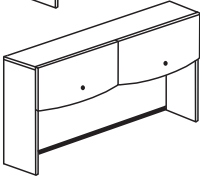
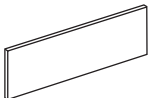
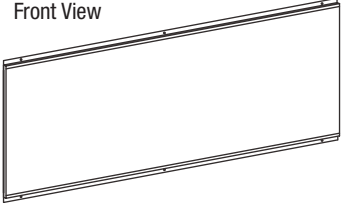

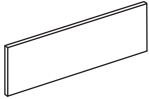
FLIPPER HUTCH STRAIGHT DOOR			Model #	W	D	H	Wt	V	TFL \$	HPL \$	Remarks
  SIN 711-2	36"H	1 Door	3 HF S 2436	24	13	36	75	3.5			<ul style="list-style-type: none"> Doors add 1" to overall depth of Flipper Door Hutches 36"H Flipper Door Hutches Interior 12"D 20" clear under doors; 22" under shelf Interior height 12" Full width wire access strip at bottom Task light wire grommet in back panel Door opens over top shelf 2 door models keyed alike Top is same finish as panels and modesty HPL option available for door faces only Shipped RTA Tack Boards (see below) Power / Data Module can be installed in hutch back panel requires 2" clearance PD 7500 – \$237 List (see pg. 7-7 for order information) 43"H Interior height 13"  <div style="border: 1px solid black; padding: 5px; margin-top: 10px;"> <p>Note: all 42"H hutch models have been altered to 43"H (with new model numbers) to match the height of 72"H freestanding storage units. 42"H models can still be ordered at same price as like sized 43"H units.</p> </div>
			3 HF S 3036	30	13	36	79	4.0			
			3 HF S 3636	36	13	36	84	4.1			
			3 HF S 4236	42	13	36	92	4.6			
			3 HF S 4836	48	13	36	106	5.4			
		2 Doors	3 HF S 5436	54	13	36	120	6.8			
	3 HF S 6036		60	13	36	133	7.5				
	3 HF S 6636		66	13	36	148	8.5				
	3 HF S 7236		72	13	36	160	9.6				
	3 HF S 7836		78	13	36	172	10.7				
	43"H	1 Door	3 HF S 3643	36	13	43	91	4.9			
			3 HF S 4243	42	13	43	99	5.4			
			3 HF S 4843	48	13	43	114	6.2			
		2 Doors	3 HF S 5443	54	13	43	129	7.6			
3 HF S 6043			60	13	43	143	8.3				
3 HF S 6643			66	13	43	159	9.3				
3 HF S 7243			72	13	43	172	10.4				
3 HF S 7843			78	13	43	185	11.5				
3 HF S 8443			84	13	43	198	12.5				
FLIPPER HUTCH CURVED DOOR											
 	36"H	1 Door	3 HF C 3636	36	13	36	84	4.1			<ul style="list-style-type: none"> 36"H Interior height 12" 43"H Curved Flipper Door Hutches Change code to 3 HF C xx43 and add 10% to List price eg: 3 HF C 6043 Clearance under 43"H models 26" to doors and 27 3/4" to shelf 43"H Interior height 13" <div style="border: 1px solid black; padding: 5px; margin-top: 10px;"> <p>Horizontal Paper Management slots available on page 1-38</p> </div>
			3 HF C 4236	42	13	36	92	4.6			
			3 HF C 4836	48	13	36	106	5.4			
	2 Doors	3 HF C 5436	54	13	36	120	6.8				
		3 HF C 6036	60	13	36	133	7.5				
		3 HF C 6636	66	13	36	148	8.5				
		3 HF C 7236	72	13	36	160	9.6				
		3 HF C 7836	78	13	36	172	10.7				
		3 HF C 8436	84	13	36	184	11.7				
FABRIC TACK BOARD – FOR 36"H HUTCHES			Model #	W	D	H	Wt	V	GRD A \$	GRD B \$	
 SIN 711-2			3 FW 22	22	0.5	16	4	0.6			Fabric Tack Board <ul style="list-style-type: none"> See Fabric Card for fabric options Wall mount requires purchase of FWHKIT at \$21 List <div style="margin-top: 20px;"> <p>Front View </p> <p>Side View </p> </div>
			3 FW 28	28	0.5	16	4	0.7			
			3 FW 34	34	0.5	16	5	0.8			
			3 FW 40	40	0.5	16	6	0.9			
			3 FW 46	46	0.5	16	7	1.2			
			3 FW 52	52	0.5	16	8	1.2			
			3 FW 58	58	0.5	16	9	1.3			
			3 FW 64	64	0.5	16	10	1.5			
			3 FW 70	70	0.5	16	11	1.6			
			3 FW 76	76	0.5	16	12	1.7			
		3 FW 82	82	0.5	16	13	1.9				
FABRIC TACK BOARD – FOR 42"H HUTCHES											
 SIN 711-2			3 FW 2822	28	0.5	21.75	6	0.9			
			3 FW 3422	34	0.5	21.75	7	1.1			
			3 FW 4022	40	0.5	21.75	9	1.2			
			3 FW 4622	46	0.5	21.75	10	1.4			
			3 FW 5222	52	0.5	21.75	11	1.6			
			3 FW 5822	58	0.5	21.75	12	1.8			
			3 FW 6422	64	0.5	21.75	14	1.9			
			3 FW 7022	70	0.5	21.75	15	2.1			
			3 FW 7622	76	0.5	21.75	16	2.3			
			3 FW 8222	82	0.5	21.75	18	2.4			

LEGEND: W=width; D=depth; H=height (inches); Wt=shipping weight (lbs); V=volume (cubic feet); TFL \$=thermally fused laminate \$; HPL \$= high pressure laminate \$

DOUBLE TIER HUTCHES

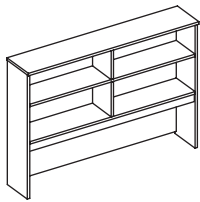
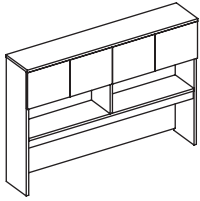
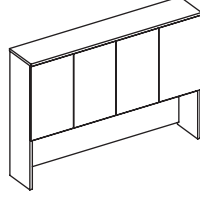
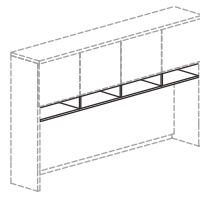

treeo®

OPEN HUTCH		Model #	W	D	H	Wt	V	TFL \$	HPL \$	Remarks	
 <p>SIN 711-2</p>		3 HHTD 3051	30	13	51	92	8.6			<ul style="list-style-type: none"> Optional valance included is 3"H <p>Open Hutches</p> <ul style="list-style-type: none"> 22" clearance under shelf; 19" clear under valance Interior height: 12" (top tier) 14" (bottom tier) Full width wire access strip at bottom Task light wire grommet in back panel Shipped RTA Top panel adds 1" to overall depth of Open Hutches 	
		3 HHTD 3651	36	13	51	104	9.6				
		3 HHTD 4251	42	13	51	116	11.7				
		3 HHTD 4851	48	13	51	127	13.8				
		3 HHTD 5451	54	13	51	147	14.3				
		3 HHTD 6051	60	13	51	158	15.5				
		3 HHTD 6651	66	13	51	170	16.8				
		3 HHTD 7251	72	13	51	182	18.5				
		3 HHTD 7851	78	13	51	193	20.3				
	3 HHTD 8451	84	13	51	205	23.3					
CUPBOARD DOOR										<p>Cupboard Door Hutches</p> <ul style="list-style-type: none"> 22" clearance under shelf; 19" clear under valance 20" clearance under full cupboard doors Interior height: 12" (top tier) 14" (bottom tier) Full width wire access strip at bottom Task light wire grommet in back panel Can specify up to 3 finishes with order (Contrast - doors, Base - sides and back, Top - top) HPL option available for door faces only Non-locking is standard Locking option-specifv: 2 doors – HDLK2 - 3 doors – HDLK3 - 4 doors – HDLK4 - Shipped RTA Tack Boards (see pg. 1-37) Doors / top panel add 1" to overall depth of Cupboard Door Hutches 	
 <p>SIN 711-2</p>	2 Doors	3 HDD 3051	30	13	51	103	8.6				
		3 HDD 3651	36	13	51	117	9.6				
		3 HDD 4251	42	13	51	131	11.7				
	3 Doors	3 HDD 4851	48	13	51	143	13.8				
		3 HDD 5451	54	13	51	165	14.3				
	4 Doors	3 HDD 6051	60	13	51	178	15.5				
		3 HDD 6651	66	13	51	191	16.8				
		3 HDD 7251	72	13	51	205	18.5				
		3 HDD 7851	78	13	51	218	20.3				
	3 HDD 8451	84	13	51	231	23.3					
FULL CUPBOARD DOOR											
 <p>SIN 711-2</p>	2 Doors	3 HDDF 3051	30	13	51	110	8.6				
		3 HDDF 3651	36	13	51	126	9.6				
		3 HDDF 4251	42	13	51	141	11.7				
	3 Doors	3 HDDF 4851	48	13	51	155	13.8				
		3 HDDF 5451	54	13	51	178	14.3				
	4 Doors	3 HDDF 6051	60	13	51	192	15.5				
		3 HDDF 6651	66	13	51	207	16.8				
		3 HDDF 7251	72	13	51	222	18.5				
		3 HDDF 7851	78	13	51	236	20.3				
		3 HDDF 8451	84	13	51	251	23.3				
	HORIZONTAL PAPER MANAGEMENT										<ul style="list-style-type: none"> Valance and task light can be mounted below Slots match width of hutch doors Shipped RTA <div style="border: 1px solid black; padding: 5px; margin-top: 10px;"> <ul style="list-style-type: none"> Flipper and cupboard doors will partly cover horizontal slots </div>
	 <p>SIN 711-2</p>	3 slots for 28" to 52"	3 SHP 28	28	12	5	13	0.8	N/A		
3 SHP 34			34	12	5	18	1.0	N/A			
3 SHP 40			40	12	5	20	1.1	N/A			
3 SHP 46			46	12	5	22	1.3	N/A			
3 SHP 52			52	12	5	26	1.4	N/A			
4 slots for 58" to 82"		3 SHP 58	58	12	5	29	1.6	N/A			
		3 SHP 64	64	12	5	32	1.7	N/A			
		3 SHP 70	70	12	5	35	1.9	N/A			
		3 SHP 76	76	12	5	38	2.1	N/A			
		3 SHP 82	82	12	5	41	2.2	N/A			

LEGEND: **W**=width; **D**=depth; **H**=height (inches); **Wt**=shipping weight (lbs); **V**=volume (cubic feet); **TFL \$**=thermally fused laminate \$; **HPL \$**= high pressure laminate \$

HUTCHES WITH FRAMED TRANSLUCENT DOORS



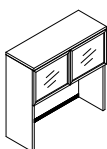
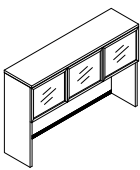
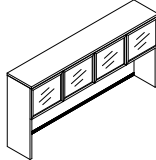
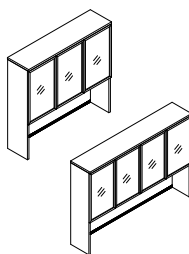
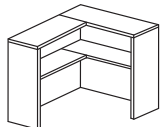
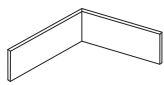



FRAMED TRANSLUCENT CUPBOARD DOOR HUTCH		Model #	W	D	H	Wt	V	TFL \$	HPL \$	Remarks	
   <p>SIN 711-2</p>	36" H 2 Doors 30" - 42"	3 HD G 3036	30	13	36	74	3.0		N/A	36"H Cupboard Door Hutches <ul style="list-style-type: none"> Doors / top panel add 1" to overall depth of Cupboard Door Hutches Interior 12"D Interior height 12" 20" clear under doors; 22" under shelf Full width wire access strip at bottom Task light wire grommet in back panel Can specify up to 2 finishes with order (Base - sides and back, Top - top) Doors are brushed aluminum with frosted acrylic insert Non-locking is standard Locking Option – specify: <ul style="list-style-type: none"> 2 doors – HDLK2 - \$87 List 3 doors – HDLK3 - \$133 List 4 doors – HDLK4 - \$144 List 43"H Cupboard Door Hutches <ul style="list-style-type: none"> As above except clearance under shelf is 27³/₄" Interior height 13" <div style="border: 1px solid black; padding: 5px; margin-top: 10px;"> Note: all 42"H hutch models have been altered to 43"H (with new model numbers) to match the height of 72"H freestanding storage units. 42"H models can still be ordered at same price as like sized 43"H units. </div> <div style="border: 1px solid black; padding: 5px; margin-top: 10px;"> Horizontal Paper Management slots available on page 1-38 </div>	
		3 HD G 3636	36	13	36	82	3.6		N/A		
		3 HD G 4236	42	13	36	87	5.2		N/A		
	3 Doors 48" - 54"	3 HD G 4836	48	13	36	94	6.5		N/A		
		3 HD G 5436	54	13	36	101	7.6		N/A		
		4 Doors 60" - 84"	3 HD G 6036	60	13	36	114	8.4			N/A
			3 HD G 6636	66	13	36	127	9.2			N/A
	43" H 30" - 42"	3 HD G 7236	72	13	36	141	10.0		N/A		
		3 HD G 7836	78	13	36	155	10.7		N/A		
		3 HD G 8436	84	13	36	169	11.7		N/A		
		2 Doors 30" - 42"	3 HD G 3043	30	13	43	81	3.8			N/A
			3 HD G 3643	36	13	43	90	4.4			N/A
	3 Doors 48" - 54"	3 HD G 4243	42	13	43	96	6.0		N/A		
		3 HD G 4843	48	13	43	104	7.3		N/A		
		3 HD G 5443	54	13	43	112	8.4		N/A		
4 Doors 60" - 84"	3 HD G 6043	60	13	43	126	9.2		N/A			
	3 HD G 6643	66	13	43	140	10.0		N/A			
	3 HD G 7243	72	13	43	155	10.8		N/A			
	3 HD G 7843	78	13	43	170	11.5		N/A			
3 HD G 8443	84	13	43	185	12.5		N/A				
DOUBLE TIER TRANSLUCENT DOOR HUTCH											
	3 Doors 48" - 54"	3 HDDF G 4851	48	13	51	139	13.8		N/A	<ul style="list-style-type: none"> Door frames (these models and above) are anodized aluminium with mitred joints. 	
		3 HDDF G 5451	54	13	51	160	14.3		N/A		
	4 Doors 60" - 84"	3 HDDF G 6051	60	13	51	172	15.5		N/A		
		3 HDDF G 6651	66	13	51	184	16.8		N/A		
		3 HDDF G 7251	72	13	51	197	18.5		N/A		
		3 HDDF G 7851	78	13	51	209	20.3		N/A		
3 HDDF G 8451	84	13	51	222	23.3		N/A				
CORNER HUTCH – TOP											
 <p>SIN 711-2</p>	36" Corner	3 HCT 3636	36	13	36	116	4.5		N/A	36" Corner Hutch with Top <ul style="list-style-type: none"> 22" clearance under shelf Interior height 12" 12¹/₄" clearance between shelves 2 piece top and shelf 	
	42" Corner	3 HCT 4236	42	13	36	134	5.2		N/A		
	48" Corner	3 HCT 4836	48	13	36	152	6.0		N/A		
CORNER FABRIC TACK BOARDS		Model #	W	W	H	Wt	V	GRD A \$	GRD B \$		
 <p>SIN 711-2</p>	36" Corner	3 FW 3636	34	34	16	12	2.6			Fabric Tack Board <ul style="list-style-type: none"> See Fabric Card for fabric options 	
	42" Corner	3 FW 4242	40	40	16	14	3.2				
	48" Corner	3 FW 4848	46	46	16	16	3.5				

LEGEND: W=width; D=depth; H=height (inches); Wt=shipping weight (lbs); V=volume (cubic feet); TFL \$=thermally fused laminate \$; HPL \$= high pressure laminate \$

SPECIALTY STORAGE

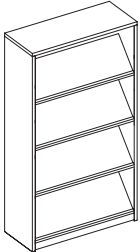

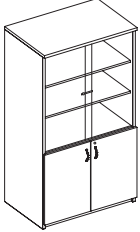
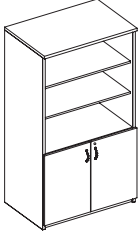
treeo®

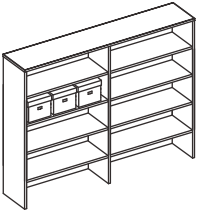
TILTED SHELF LITERATURE RACKS		Model #	W	D	H	Wt	V	TFL \$	HPL \$	Remarks
 <p>SIN 711-3</p>		3 SLR 4215	36	15	42	95	6.0			Tilted Shelf Literature Racks <ul style="list-style-type: none"> • 42" h unit has 3 tilted shelves • 65" h unit has 4 tilted shelves • Each tilted shelf has a fixed shelf behind it for additional storage • Shipped RTA
		3 SLR 6515	36	15	65	120	8.0			
TROPHY / DISPLAY CASES										
 <p>SIN 711-3</p>	36" Wide	3 SDC 3620 (-)	36	20	65	250	33.0			Trophy / Display Cases <ul style="list-style-type: none"> • Locks included on both glass and door sections • 2 shelves above; 1 below • Shipped RTA, glass packed separately • 48" w version has center support • Options include: full glass front and glass shelves. Call INLINE Sales Rep for quote • 72" H version also available
		3 SDC 3624 (-)	36	24	65	270	36.0			
	48" Wide	3 SDC 4820 (-)	48	20	65	313	35.0			
		3 SDC 4824 (-)	48	24	65	338	39.0			
LIBRARY STORAGE										
 <p>SIN 711-3</p>		3 SPO 3620 (-)	36	20	65	237	33.0			Library Storage <ul style="list-style-type: none"> • 2 adjustable shelves above; 1 below • Locks included on bottom section • Shipped assembled
		3 SPO 3624 (-)	36	24	65	257	36.0			
BANKERS BOX STORAGE										
   <p>SIN 711-3</p>	42" Wide	3 - High 3 SBB 4241	42	17	41	91	2.4	N/A	Bankers Box Storage <ul style="list-style-type: none"> • Each opening on 42" holds 3 Bankers Boxes • Each opening on 72" holds 5 Bankers Boxes • Each opening on 86" holds 6 Bankers Boxes • 41" h unit has 3 openings • 54" h unit has 4 openings • 67" h unit has 5 openings • Top can be used as additional shelf • 72" w unit has offset center divider to maximize storage space • 86" w unit has center divider • Bottom is open to floor • Shipped RTA • Shelves can be made to extend and retract. Call factory for details. (List price \$160 ea.) 	
		4 - High 3 SBB 4254	42	17	54	121	2.7	N/A		
		5 - High 3 SBB 4267	42	17	67	152	3.1	N/A		
	72" Wide	3 - High 3 SBB 7241	72	17	41	131	4.0	N/A		
		4 - High 3 SBB 7254	72	17	54	174	4.6	N/A		
		5 - High 3 SBB 7267	72	17	67	217	5.2	N/A		
	86" Wide	3 - High 3 SBB 8641	86	17	41	150	4.6	N/A		
		4 - High 3 SBB 8654	86	17	54	199	5.5	N/A		
		5 - High 3 SBB 8667	86	17	67	248	6.0	N/A		

LEGEND: **W**=width; **D**=depth; **H**=height (inches); **Wt**=shipping weight (lbs); **V**=volume (cubic feet); **TFL \$**=thermally fused laminate \$; **HPL \$**= high pressure laminate \$

MEETING ROOM ACCESSORIES



tréo®

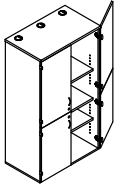
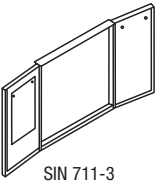
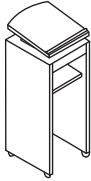
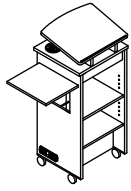
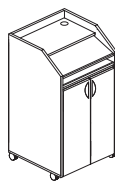
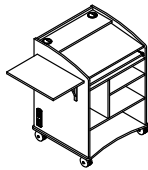
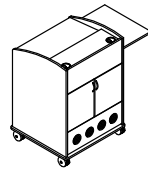
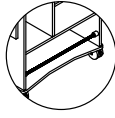
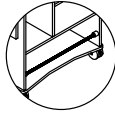

AV CABINET		Model #	W	D	H	Wt	V	TFL \$	HPL \$	Remarks
 SIN 711-3	AV Cabinet	3 PAV 3624 (-)	36	24	65	235	36.0			<ul style="list-style-type: none"> • 270° fold-away top doors • 1 fixed shelf, 2 adjustable shelves • Opening for TV is max. 34"W x 35"H with adjustable top shelf removed • Fully ventilated • Wire access top to bottom • Locks top and bottom • Mobile version has 3" casters • Shipped assembled
		3 PAVM 3624 (-)	36	24	65	237	36.0			
WHITE BOARD										
 SIN 711-3	White Board	Non-magnetic White Board								<ul style="list-style-type: none"> • Tackable surface inside one door, Fabric is Opal (AOP011) only • Hooks for flip chart on other door • HPL option for door faces only • Marker tray included on ledge • Shipped assembled
		Magnetic White Board	3 PWB 4848 (-)	48	6	48	143	11.8		
		3 PWBM 4848 (-)	48	6	48	143	11.8			
LECTERN										
 SIN 711-2	Lectern	3 PLC 4420	21	21	44	75	3.6		N/A	<ul style="list-style-type: none"> • Sloping top shelf with paper stop • Fixed shelf underneath • On casters, front locking • Casters mounted to metal channel
AV LECTERN										
 SIN 711-2	AV Lectern	3 PLAV 2020	21	21	44	96	14.1		N/A	<ul style="list-style-type: none"> • Sloping top shelf with paper stop • Flip-out side shelf for extra work surface • Power and data connections at floor connected to PD4500 at user level • On casters, front locking • Casters mounted to metal channel • One fixed and one adjustable shelf
MULTIMEDIA PODIUM										
 SIN 711-3	Podium	3 SMM 2424 (-)	24	24	42	98	4.0		N/A	<ul style="list-style-type: none"> • Wire access from top to interior components • Paper retention strip on slanted surface • Retractable shelf for keyboard • Two adjustable shelves behind locking doors • Lower front area has fabric covered speaker port-holes (fabric in black only) • Four casters, two locking
LARGE AV PODIUM										
 Front		3 PLAV 3230 (-)	32	30	44	125	20.0			<ul style="list-style-type: none"> • Flip-out side shelf for extra work surface • On-board power and data connections at the floor • On casters, front locking • Roll out keyboard tray • Top features slopping document surface and flat monitor/equipment area • HPL price includes high pressure laminate on dual top, flip-out surface and keyboard tray • Locking door option adds lock to rear doors too
 Back										
	Foot Rail	3 PLAV 32 FR	-	-	-	-	-			
 Locking Doors	Locking Doors	3 PLAV 32 DR	-	-	-	19	1.1			
 Second Flip-up Surface	Second Flip-up Surface	3 PLAV 32 FL	-	-	-	8	.5			
SIN 711-3										

LEGEND: W=width; D=depth; H=height (inches); Wt=shipping weight (lbs); V=volume (cubic feet); TFL \$=thermally fused laminate \$; HPL \$= high pressure laminate \$

MEETING ROOM ACCESSORIES

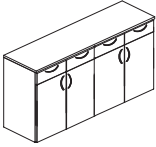

tree®

MOBILE SERVING CART		Model #	W	D	H	Wt	V	TFL \$	HPL \$	Remarks
 SIN 711-3	Serving Cart 3 PSC 2020 (-)	19	20	36	114	11				<ul style="list-style-type: none"> • Pull-out shelf at top • Full extension drawer slides • HPL option on top only • Need to select handle style and finish • Four casters, 2 locking • One adjustable shelf behind door
MOBILE SERVING BUFFET		Model #	W	D	H	Wt	V	TFL \$	HPL \$	Remarks
 SIN 711-3	Serving Buffet 3 PSBM 3620 (-)	36	20	36	179	19				<ul style="list-style-type: none"> • Pull-out shelf at top • Full extension drawer slides • HPL option on top only • Need to select handle style and finish • Four casters, 2 locking • One adjustable shelf behind door • Locking option on cupboard doors, order HDLK2 - \$87 List (installed)
MEETING ROOM BUFFET		Model #	W	D	H	Wt	V	TFL \$	HPL \$	Remarks
 SIN 711-3	Meeting Room Buffet 3 PSB 3620 (-)	36	20	36	179	19				<ul style="list-style-type: none"> • 4 full extension drawers along top • 2 adjustable shelves in each section • HPL option on top only • Need to select handle style and finish • Locking option on cupboard doors, order HDLK4 - \$144 List (installed)
	Meeting Room Buffet 3 PSB 7220 (-)	72	20	36	358	38				
		<div style="border: 1px solid black; padding: 5px; display: inline-block;"> Enter Handle Selection to complete code </div>								<div style="border: 1px solid black; padding: 5px; display: inline-block;"> 4 Handles to choose from: K1 Black, Tear Drop K2 Black, Wire N1 Nickel, Tear Drop N2 Nickel, Wire </div>

LEGEND: **W**=width; **D**=depth; **H**=height (inches); **Wt**=shipping weight (lbs); **V**=volume (cubic feet); **TFL \$**=thermally fused laminate \$; **HPL \$**= high pressure laminate \$

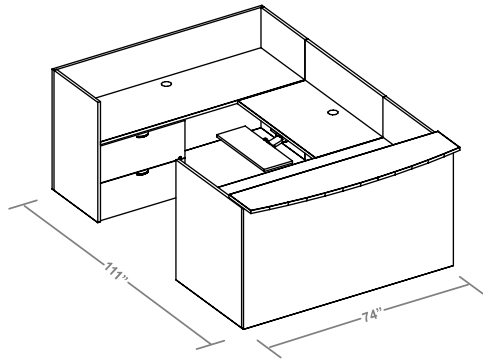

GALLERY RECEPTION: SUITE #TR021

Item	Model
Desk	3 RGR 7236
Transaction Counter	3 HBGR 7215
Credenza	3 RGR 7224
Bridging Top	3 BFGR 4224
Keyboard	3 KM 2610 L
Lateral File	3 SLU 3020

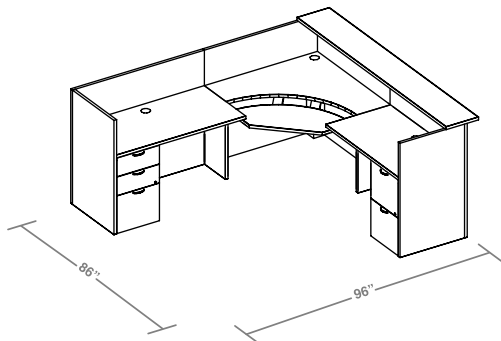

GALLERY L-GROUP: SUITE #TR022

Item	Model
Corner w/ Keyboard	3 CGRF 4224 S
Transaction Counter	3 HAGR 8412
Left Return	3 EGR 4824 L
Right Return	3 EGR 4224 R
Floor Ped (B/B/F)	3 SJX 20
Floor Ped (F/F)	3 SJY 20

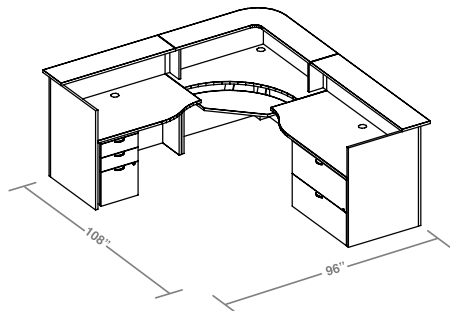

CURVED GALLERY L-GROUP: SUITE #TR023

Item	Model
Corner w/ Keyboard	3 CGRF 4224 S
Corner Counter	3 HCGS 4212
Left Return	3 TGR 4830 R24
Transaction Counter	3 HAGR 4812
Right Return	3 TGR 6030 L24
Transaction Counter	3 HAGR 6012
Mobile Ped (B/B/F)	3 SMX 24
Lateral File	3 SLU 3624
Counter Supports (2 @ \$53)	3 LGW 4

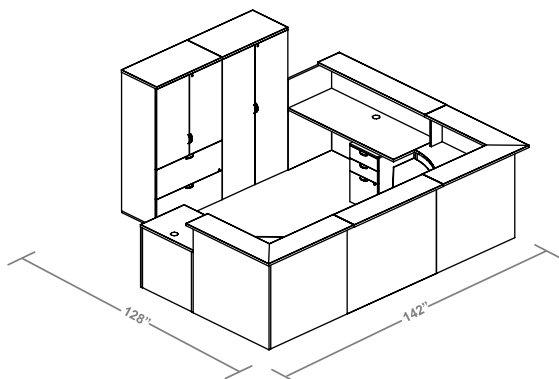

TWO PERSON GALLERY U-GROUP: SUITE #TR024

Item	Model
Corner w/ Keyboard (2 @ \$1493)	3 CGRF 4224 S
Corner Counter (2 @ \$373)	3 HCGR 4212
Bridging Top	3 BFGR 4824
Transaction Counter	3 HAGR 4812
Left Return	3 EGR 6024 L
Transaction Counter	3 HAGR 6012
Right Return	3 TF 3024-Y
Mobile Ped (2 @ \$673)	3 SMX 20
Tall Storage	3 SPB 3620
Tall Storage / Filing	3 SPF 3620

NOTE: All prices above are TFL

GALLERY / RECEPTION DESKS



tree®

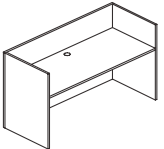
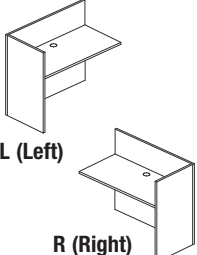
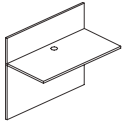
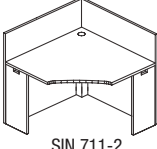
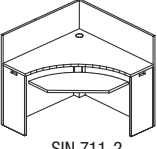
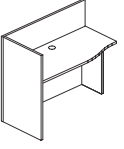
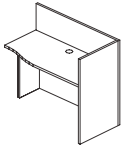



GALLERY DESKS		Model #	W	D	Wt	V	TFL \$	HPL \$	Remarks
 SIN 711-2	24"D Worksurface	3 RGR 7224	74	25	175	6.8			<ul style="list-style-type: none"> Codes represent actual top sizes. Overall size increased by 1" for each end panel and modesty panel Woodgrain on modesty panel is horizontal due to 72" width Grain is vertical on end panels
	30"D Worksurface	3 RGR 7230	74	31	199	7.2			
	36"D Worksurface	3 RGR 7236	74	37	223	7.6			
STRAIGHT GALLERY RETURNS									
 L (Left) R (Right) SIN 711-2	Left	3 EGR 3624 L	37	25	88	3.6			<ul style="list-style-type: none"> Includes top, gallery height modesty, gallery height end panel, two connecting flat brackets Tops have cross-grain Grain is vertical on end panels and modesties Codes represent actual top sizes. Overall size increased by 1" for each end panel and modesty panel
		3 EGR 4224 L	43	25	98	4.2			
		3 EGR 4824 L	49	25	108	4.7			
	Right	3 EGR 5424 L	55	25	118	5.3			
		3 EGR 6024 L	61	25	128	5.8			
		3 EGR 3624 R	37	25	88	3.6			
3 EGR 4224 R	43	25	98	4.2					
3 EGR 4824 R	49	25	108	4.7					
3 EGR 5424 R	55	25	118	5.3					
3 EGR 6024 R	61	25	128	5.8					
BRIDGING GALLERY TOPS									
 SIN 711-2		3 BFGR 3624	36	25	61	2.6			<ul style="list-style-type: none"> Includes top, gallery height modesty panel, 4 flat-brackets Center grommet Tops have cross-grain Vertical grain on modesties Codes represent actual top sizes. Overall depth increased by 1" for modesty panel only.
		3 BFGR 4224	42	25	71	3.0			
		3 BFGR 4824	48	25	81	3.4			
GALLERY CORNER – NO KEYBOARD									
 SIN 711-2	36" Curved Corner	3 CGR3624 C	37	37	126	4.7			<ul style="list-style-type: none"> Includes top, gallery modesties and two recessed legs Vertical grain on modesties Codes are nominal sizes Actual dimensions increased by 1" modesty panels
	42" Curved Corner	3 CGR4224 C	43	43	151	5.4			
GALLERY CORNER – INTEGRATED KEYBOARD									
 SIN 711-2	Single Arm Keyboard	3 CGRK 3624 S	37	37	151	6.7			<ul style="list-style-type: none"> as above Single arm "KM" keyboard is used on 36" corner Double arm "KF" keyboard is used on 42" corner
	Double Arm Keyboard	3 CGRF 4224 S	43	43	176	7.4			
CURVED GALLERY RETURNS – LEFT									
 SIN 711-2	24/30"D Worksurface	3 TGR 3030 R24	31	31	96	3.1			<ul style="list-style-type: none"> Includes top, gallery modesty, gallery-height end panel, one recessed leg and hardware Grain is length-wise on Tops End panels and modesties are vertical grain
		3 TGR 3630 R24	37	31	107	3.6			
		3 TGR 4230 R24	43	31	118	4.2			
		3 TGR 4830 R24	49	31	130	4.7			
		3 TGR 5430 R24	55	31	141	5.3			
		3 TGR 6030 R24	61	31	152	5.8			
CURVED GALLERY RETURNS – RIGHT									
 SIN 711-2	24/30"D Worksurface	3 TGR 3030 L24	31	31	96	3.1			<ul style="list-style-type: none"> as above
		3 TGR 3630 L24	37	31	107	3.6			
		3 TGR 4230 L24	43	31	118	4.2			
		3 TGR 4830 L24	49	31	130	4.7			
		3 TGR 5430 L24	55	31	141	5.3			
		3 TGR 6030 L24	61	31	152	5.8			

LEGEND: W=width; D=depth; H=height (inches); Wt=shipping weight (lbs); V=volume (cubic feet); TFL \$=thermally fused laminate \$; HPL \$= high pressure laminate \$

GALLERY / RECEPTION DESKS

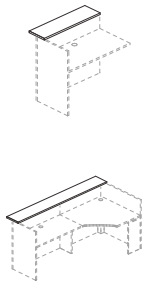
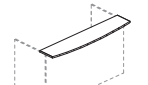
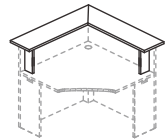

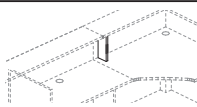
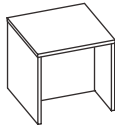

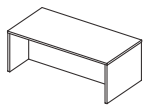
tréo®

TWO PIECE CORNER COUNTER		Model #	W	D	Wt	V	1" Thick TFL \$	1" Thick HPL \$	1.5" Thick TFL \$	1.5" Thick HPL \$	Remarks
 <p>SIN 711-2</p>	Spans Single Top	3/4 HAGR 3012	31	12	12.1	0.7					<ul style="list-style-type: none"> • Shorter lengths span returns / corners only • Counters overhang 4" to guest side • Use "3" prefix for tréo® (1") • Use "4" prefix for Boardwalk™ (1 1/2") • Longer lengths for spanning combinations of corners and returns
		3/4 HAGR 3612	37	12	13.6	0.8					
		3/4 HAGR 4212	43	12	15.4	0.9					
		3/4 HAGR 4812	49	12	17.3	1.0					
		3/4 HAGR 5412	55	12	19.2	1.1					
		3/4 HAGR 6012	61	12	21.1	1.2					
	Spans Two Tops	3/4 HAGR 6612	68	12	22.9	1.3					
		3/4 HAGR 7212	74	12	24.8	1.4					
		3/4 HAGR 7812	80	12	27.0	1.6					
		3/4 HAGR 8412	86	12	28.9	1.7					
		3/4 HAGR 9012	92	12	30.8	1.8					
		3/4 HAGR 9612	98	12	32.6	1.9					
		3/4 HAGR 10212	104	12	34.5	2.0					
BOW FRONT TRANSACTION COUNTER											
 <p>SIN 711-2</p>		3/4 HBGR 7215	74	15	30.9	1.7				<ul style="list-style-type: none"> • Counters overhang to guest side by 4" at end, 7" in middle. 	
TWO PIECE CORNER COUNTER											
 <p>SIN 711-2</p>	36" x 36" Corner	3/4 HCGR 3612	41	12	31	1.4				<ul style="list-style-type: none"> • Includes 2 tops, 2 recessed supports, and attachment hardware. • Two pieces meet at 45° angle. • Tops offset 4" to outside and 7" to inside. • Use "3" prefix for tréo® (1") • Use "4" prefix for Boardwalk™ (1 1/2") 	
	42" x 42" Corner	3/4 HCGR 4212	47	12	35	1.5					
ONE PIECE CORNER COUNTER											
 <p>SIN 711-2</p>	36" x 36" Corner	3/4 HCGS 3612	41	41	33	1.8				<ul style="list-style-type: none"> • Tops offset 4" to outside and 7" to inside. • If abutting to another transaction counter, order one 3LGS4 recessed support for each end abutting a counter 	
	42" x 42" Corner	3/4 HCGS 4212	47	47	37	2.4					
RECESSED COUNTER SUPPORT											
 <p>SIN 711-2</p>		3 LGS 4		4	13	1.4	0.1			<ul style="list-style-type: none"> • Supports counters where two meet end-to-end • Drilling template provided to secure to worksurface • Flat brackets included to join counters 	
SQUARE END TABLE		Model #	W	D	H	Wt	V	TFL \$	HPL \$		
	Cross Base	3 RCS 2222	22	22	21	35	1.1			<ul style="list-style-type: none"> • Boardwalk™ units (1 1/2" top) available on pg 3-36. 	
		3 RCS 2626	26	26	21	37	1.5				
	Panel End	3 RCSF 2222	22	22	21	35	1.1				
		3 RCSF 2626	26	26	21	37	1.5				
ROUND END TABLE											
	Round Cross Base	3 RCR 2424	24	24	21	42	1.3			<ul style="list-style-type: none"> • Boardwalk™ units (1 1/2" top) available on pg 3-36. 	
RECTANGULAR COFFEE TABLE											
 <p>SIN 711-11</p>	Rectangular Panel End	3 RCSF 3618	36	18	18	40	1.4			<ul style="list-style-type: none"> • Boardwalk™ units (1 1/2" top) available on pg 3-36. 	
		3 RCSF 4824	48	24	18	55	3.0				

LEGEND: W=width; D=depth; H=height (inches); Wt=shipping weight (lbs); V=volume (cubic feet); TFL \$=thermally fused laminate \$; HPL \$= high pressure laminate \$

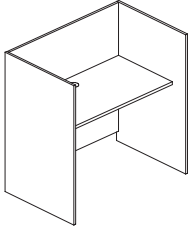
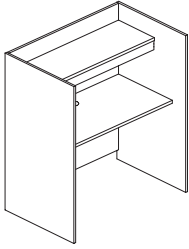
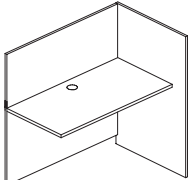
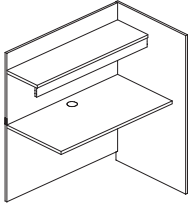
SINGLE / LINKING STUDY CARRELS



STAND ALONE CARREL – 48" H		Model #	W	D	H	Wt	V	TFL \$	HPL \$	Remarks	
 <p>SIN 711-2</p>	24"D	3 CR 3624 C	36	24	48	89	4.4			<p>Stand Alone Carrels</p> <ul style="list-style-type: none"> • Work surface height - 28" • 24"D Models have 20"D work surface • 30"D Models have 24"D work surface • Work surface and end panels 1" thick; back panels 3/4" thick • 54"H versions have 12"D shelf with 3"H valance. Shelf clearance is 22 1/4" • Modesty panel is raised 3" for wire access • Carrels come standard with one grommet in work surface • Stand alone carrels can be ordered with a grommet in both side panels. To order, change product code suffix "C" to "G" and add \$50 List. • Glides have 1 1/2" stem • See pages 7-5 and 7-6 for Wire Management Accessories 	
		3 CR 4224 C	42	24	48	97	5.1				
		3 CR 4824 C	48	24	48	105	5.8				
	30"D	3 CR 3630 C	36	30	48	103	4.4				
		3 CR 4230 C	42	30	48	112	5.1				
		3 CR 4830 C	48	30	48	121	5.8				
STAND ALONE CARREL – 54" H											
 <p>SIN 711-2</p>	24"D	3 CRH 3624 C	36	24	54	98	4.9				
		3 CRH 4224 C	42	24	54	107	5.7				
		3 CRH 4824 C	48	24	54	116	6.5				
	30"D	3 CRH 3630 C	36	30	54	113	4.9				
		3 CRH 4230 C	42	30	54	123	5.7				
		3 CRH 4830 C	48	30	54	132	6.5				
ADD-ON CARREL – 48" H											
 <p>SIN 711-2</p>	24"D	3 CL 3624 C	35	24	48	68	3.3			<p>Add-on Carrels</p> <ul style="list-style-type: none"> • Connects to stand alone carrel to make a run • General specifications as above • Carrels come standard with one grommet in work surface • Add-on carrels come standard with a wire management cut-out in the side panel • Glides have 1 1/2" stem • See Accessories pages for cable management, task lights etc. 	
		3 CL 4224 C	41	24	48	76	3.8				
		3 CL 4824 C	47	24	48	84	4.3				
	30"D	3 CL 3630 C	35	30	48	77	3.3				
		3 CL 4230 C	41	30	48	85	3.8				
		3 CL 4830 C	47	30	48	94	4.3				
ADD-ON CARREL – 54" H											
 <p>SIN 711-2</p>	24"D	3 CLH 3624 C	35	24	54	74	3.7				
		3 CLH 4224 C	41	24	54	83	4.3				
		3 CLH 4824 C	47	24	54	92	4.8				
	30"D	3 CLH 3630 C	35	30	54	84	3.7				
		3 CLH 4230 C	41	30	54	93	4.3				
		3 CLH 4830 C	47	30	54	103	4.8				
FABRIC TACK BOARD		Model #	W	D	H	Wt	V	GRD A \$	GRD B \$		
 <p>SIN 711-2</p>	3 CRTB 34	34	0.75	16	6	1.8				<p>Fabric Tack Board</p> <ul style="list-style-type: none"> • See Fabric Card for fabric options 	
	3 CRTB 40	40	0.75	16	6	2.0					
	3 CRTB 46	46	0.75	16	6	2.2					
<p>Study carrels can be customized and even electrified to accommodate larger projects</p>											

LEGEND: W=width; D=depth; H=height (inches); Wt=shipping weight (lbs); V=volume (cubic feet); TFL \$=thermally fused laminate \$; HPL \$= high pressure laminate \$

DOUBLE / LINKING STUDY CARRELS

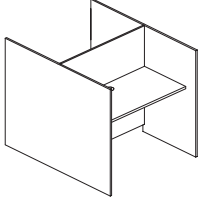
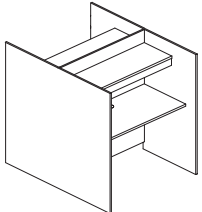
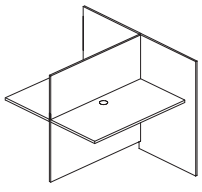
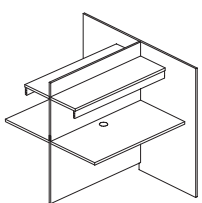

treo®

STAND ALONE CARREL – 48" H		Model #	W	D	H	Wt	V	TFL \$	HPL \$	Remarks	
 <p>SIN 711-2</p>	24"D	3 CR 3648 C	36	48	48	149	7.5			Stand Alone Carrels <ul style="list-style-type: none"> • Work surface height - 28" • 24"D Models have 20"D work surface • 30"D Models have 24"D work surface • Work surface and end panels 1" thick, back panels 3/4" thick • 54"H versions have 12"D shelf with 3"H valance. Shelf clearance is 22 1/4" • Modesty panel is raised 3" for wire access • Carrels come standard with one grommet in each work surface • Stand alone carrels can be ordered with 2 grommets in both side panels (two for each individual carrel). To order, change product code suffix "C" to "G" and add \$100 List. • Glides have 1 1/2" long stem • See pages 7-5 and 7-6 for Wire Management Accessories 	
		3 CR 4248 C	42	48	48	160	7.5				
		3 CR 4848 C	48	48	48	172	7.5				
	30"D	3 CR 3660 C	36	60	48	177	9.3				
		3 CR 4260 C	42	60	48	190	9.3				
		3 CR 4860 C	48	60	48	202	9.3				
STAND ALONE CARREL – 54" H		Model #	W	D	H	Wt	V	TFL \$	HPL \$		Remarks
 <p>SIN 711-2</p>	24"D	3 CRH 3648 C	36	48	54	188	8.4				
		3 CRH 4248 C	42	48	54	205	8.4				
		3 CRH 4848 C	48	48	54	221	8.4				
	30"D	3 CRH 3660 C	36	60	54	219	10.4				
		3 CRH 4260 C	42	60	54	237	10.4				
		3 CRH 4860 C	48	60	54	255	10.4				
ADD-ON CARREL – 48" H		Model #	W	D	H	Wt	V	TFL \$	HPL \$	Remarks	
 <p>SIN 711-2</p>	24"D	3 CL 3648 C	35	48	48	107	6.8			Add-on Carrels <ul style="list-style-type: none"> • Connects to stand alone carrel to make a run • General specifications as above • Carrels come standard with one grommet in each work surface • Add-on carrels come standard with a wire management cut-out in the side panel • Glides have 1 1/2" long stem • See Accessories pages for cable management, task lights etc. 	
		3 CL 4248 C	41	48	48	118	6.8				
		3 CL 4848 C	47	48	48	129	6.8				
	30"D	3 CL 3660 C	35	60	48	124	8.4				
		3 CL 4260 C	41	60	48	137	8.4				
		3 CL 4860 C	47	60	48	149	8.4				
ADD-ON CARREL – 54" H		Model #	W	D	H	Wt	V	TFL \$	HPL \$		Remarks
 <p>SIN 711-2</p>	24"D	3 CLH 3648 C	35	48	54	141	7.6				
		3 CLH 4248 C	41	48	54	157	7.6				
		3 CLH 4848 C	47	48	54	173	7.6				
	30"D	3 CLH 3660 C	35	60	54	160	9.4				
		3 CLH 4260 C	41	60	54	177	9.4				
		3 CLH 4860 C	47	60	54	195	9.4				
FABRIC TACK BOARD		Model #	W	D	H	Wt	V	GRD A \$	GRD B \$	Remarks	
 <p>SIN 711-3</p>	3 CRTB 34	34	0.75	16	6	1.8				Fabric Tack Board <ul style="list-style-type: none"> • See Fabric Card for fabric options • Pricing is for one tack board for each individual carrel 	
	3 CRTB 40	40	0.75	16	6	2.0					
	3 CRTB 46	46	0.75	16	6	2.2					
<div style="border: 1px solid black; padding: 5px; display: inline-block;"> Study carrels can be customized and even electrified to accommodate larger projects </div>											

LEGEND: W=width; D=depth; H=height (inches); Wt=shipping weight (lbs); V=volume (cubic feet); TFL \$=thermally fused laminate \$; HPL \$= high pressure laminate \$

Single Sided

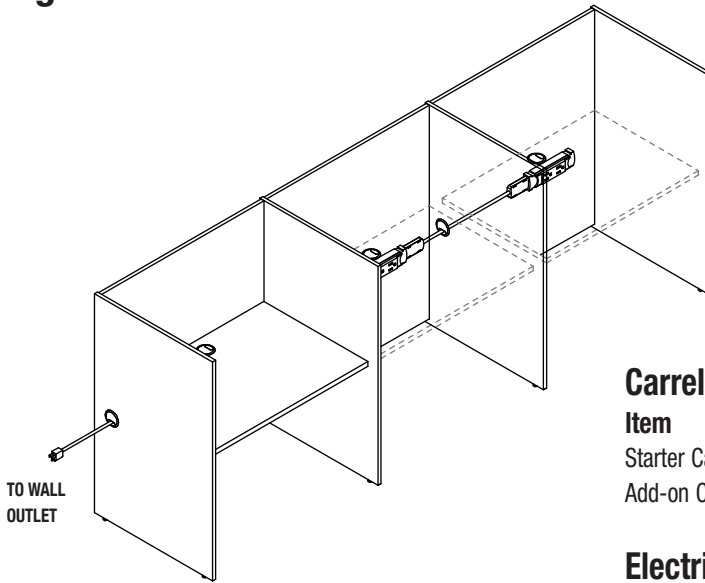

Side View

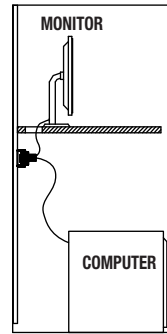

Carrel Components

Item	Model	Qty
Starter Carrel w/ Grommet	3 CR 4224 G	1
Add-on Carrel	3 CL 4224 C	2

Electrical Components

Item	Model	Qty
Duplex Block (installed)	ELD22	3
Plug-in Starter Cable	ELDSP72	1
Linking Cable	ELDL36	2

Double Sided

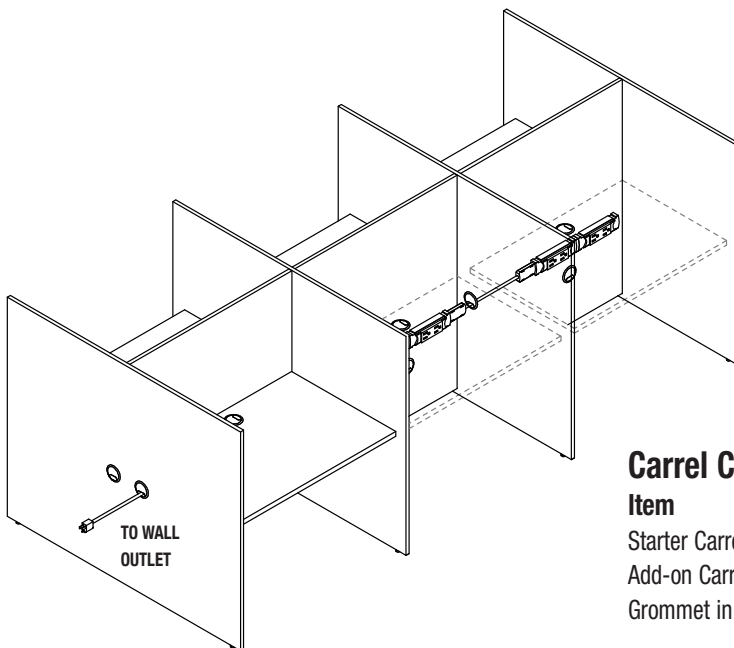

Side View

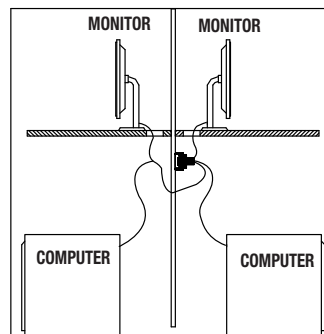

Back to back carrels can share a single sided electrical system. Wires run through grommets in back panels.

Carrel Components

Item	Model	Qty
Starter Carrel w/ Grommet	3 CR 4248 G	1
Add-on Carrel	3 CL 4248 C	2
Grommet in Back Panel	GC6000	3

Electrical Components

Item	Model	Qty
Duplex Block (installed)	ELD22	6
Duplex Block Connector	ELDCN	3
Plug-in Starter Cable	ELDSP72	1
Linking Cable	ELDL36	2

MAIL ROOM FURNITURE

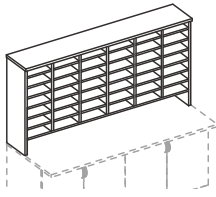
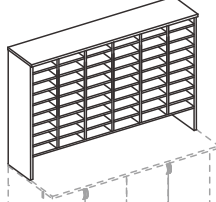
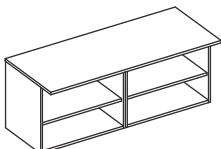
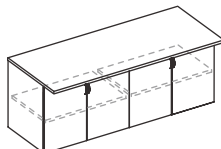
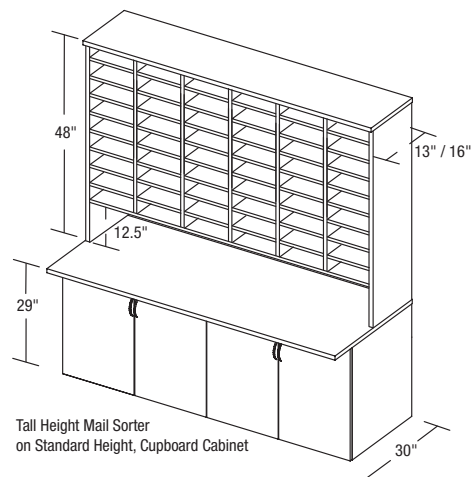
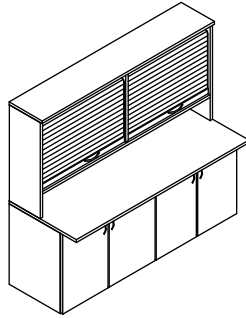

treo®

MAIL SORTERS – STANDARD HEIGHT (36")		Model #	W	D	H	Wt	V	TFL \$	HPL \$	Remarks			
 <p>SIN 711-2</p>	13"D Units	3 HMS 361336	36	13	36	148	5.3		N/A	MAIL SORTERS <ul style="list-style-type: none"> Units have one bay for each foot of width eg: 3 HMS 361336 has 3 bays All outer bays are 10.55"w; all inner bays are 11.25"w Standard height units – each bay contains 6 – 3/4" thick TFL shelves, making 7 slots / bay Tall height units – each bay contains 8 – 3/4" thick TFL shelves, making 9 slots / bay Shelves adjustable on 1.9" centers Standard height Mail Sorters have 8.4" clear under bottom shelf Tall height Mail Sorters have 12 1/2" clear under bottom shelf 13"D units - Top is 14"D; uprights 13"D; shelves 12"D 16"D units - Top is 17"D; uprights 16"D; shelves 15"D Grommet under bottom shelf Tambour door upper sorters also available. (Call factory for quote; see below) 			
		3 HMS 481336	48	13	36	192	6.9		N/A				
		3 HMS 601336	60	13	36	237	10.0		N/A				
		3 HMS 721336	72	13	36	281	11.8		N/A				
	16"D Units	3 HMS 361636	36	16	36	177	6.2		N/A				
		3 HMS 481636	48	16	36	230	8.1		N/A				
		3 HMS 601636	60	16	36	283	11.4		N/A				
		3 HMS 721636	72	16	36	336	13.5		N/A				
		MAIL SORTERS – TALL HEIGHT (48")											
		 <p>SIN 711-2</p>	13"D Units	3 HMS 361348	36	13	48	183	6.9			N/A	
3 HMS 481348	48			13	48	238	10.5		N/A				
3 HMS 601348	60			13	48	293	14.9		N/A				
3 HMS 721348	72			13	48	347	17.7		N/A				
16"D Units	3 HMS 361648		36	16	48	219	8.1		N/A				
	3 HMS 481648		48	16	48	284	12.0		N/A				
	3 HMS 601648		60	16	48	349	16.7		N/A				
	3 HMS 721648		72	16	48	415	19.9		N/A				
	BASE CABINETS (OPEN) – STD HEIGHT (30")												
	 <p>SIN 711-3</p>			3 SMO 363029	36	30	29	130	5.2		662	STANDARD HEIGHT BASE CABINETS (OPEN) <ul style="list-style-type: none"> Cabinets are 24"D with 30"D overhanging top panel to create "toe kick" area Cabinet has one adjustable shelf Open cabinets are predrilled for later addition of locking cupboard doors 	
		3 SMO 483029	48	30	29	169	6.8		856				
		3 SMO 603029	60	30	29	208	9.6		1040				
		3 SMO 663029	66	30	29	188	10.5		1061				
		3 SMO 723029	72	30	29	260	11.5		1218				
		Note: 66"W units have 30"W open area for use with other cabinets in corner configurations (see pg. 1-50)											
BASE CABINETS (CUPBOARD) – STD HEIGHT (30")													
 <p>SIN 711-3</p>		3 SMD 363029	36	30	29	150	6.0			STANDARD HEIGHT BASE CABINETS (CUPBOARD) <ul style="list-style-type: none"> Cabinets are 24"D with 30"D overhanging top panel to create "toe kick" area Cabinet has one adjustable shelf except 48"W model where shelf is fixed Cupboard doors are locking 			
		3 SMD 483029	48	30	29	196	7.8						
		3 SMD 603029	60	30	29	242	10.8						
		3 SMD 663029	66	30	29	208	11.9						
		3 SMD 723029	72	30	29	300	12.9						
		Note: 66"W units have 30"W open area for use with other cabinets in corner configurations (see pg. 1-50)											
<div style="display: flex; justify-content: space-between;"> <div style="width: 30%;"> , 16", 36", 8.4", 29", 30" data-bbox="70 720 360 910"/> <p>Standard Height Mail Sorter on Standard Height, Open Cabinet</p> </div> <div style="width: 30%;">  <p>Tall Height Mail Sorter on Standard Height, Cupboard Cabinet</p> </div> <div style="width: 30%;"> <p>HPL \$ applies to tops only</p> <p>ALL ITEMS ON THIS PAGE SHIP RTA</p>  <p>Tambour Door Upper Sorter</p> </div> </div>													

LEGEND: W=width; D=depth; H=height (inches); Wt=shipping weight (lbs); V=volume (cubic feet); TFL \$=thermally fused laminate \$; HPL \$= high pressure laminate \$

MAIL ROOM FURNITURE



tree®

BASE CABINETS (OPEN) – TALL HEIGHT (36")

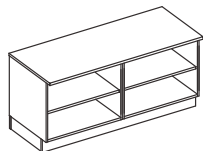

SIN 711-3

Model #	W	D	H	Wt	V
3 SMO 363036	36	30	36	140	6.0
3 SMO 483036	48	30	36	176	7.8
3 SMO 603036	60	30	36	313	10.8
3 SMO 663036	66	30	36	339	11.9
3 SMO 723036	72	30	36	364	12.9

Note: 66"W units have 30"W open area for use with other cabinets in corner configurations (see example below)

TALL HEIGHT BASE CABINETS (OPEN)

- Cabinets are 28"D x 30"H with 30"D overhanging top panel, cabinet rests on 24"D x 6"H base to create "toe kick" area
- Cabinet has one adjustable shelf mounted on metal shelf standards
- Open cabinets are predrilled for later addition of locking cupboard doors

BASE CABINETS (CUPBOARD) – TALL HEIGHT (36")

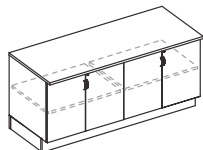

SIN 711-3

Model #	W	D	H	Wt	V
3 SMD 363036	36	30	36	159	6.7
3 SMD 483036	48	30	36	201	8.8
3 SMD 603036	60	30	36	344	12.0
3 SMD 663036	66	30	36	373	13.2
3 SMD 723036	72	30	36	401	14.3

Note: 66"W units have 30"W open area for use with other cabinets in corner configurations (see example below)

TALL HEIGHT BASE CABINETS (CUPBOARD)

- Cabinets are 28"D x 30"H with 30"D overhanging top panel, cabinet rests on 24"D x 6"H base to create "toe kick" area
- Cabinet has one adjustable shelf mounted on metal shelf standards except 48"W model where shelf is fixed
- Cupboard doors are locking
- Tambour door upper sorters also available. (Call factory for quote)

BASE CABINETS (TAMBOUR) – TALL HEIGHT (36")

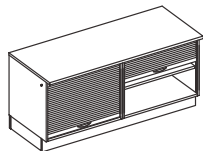

SIN 711-3

Model #	W	D	H	Wt	V
3 SMT 363036	36	30	36	150	23.8
3 SMT 483036	48	30	36	189	31.2
3 SMT 603036	60	30	36	339	38.5
3 SMT 663036	66	30	36	356	42.2
3 SMT 723036	72	30	36	383	45.8

Note: 66"W units have 30"W open area for use with other cabinets in corner configurations (see example below)

TALL HEIGHT BASE CABINETS (TAMBOUR DOOR)

- Cabinets are 28"D x 30"H with 30"D overhanging top panel, cabinet rests on 24"D x 6"H base to create "toe kick" area
- Cabinet has one adjustable shelf mounted on metal shelf standards
- Roll-up tambour doors are locking and come in silver only

EXTRA SHELVES / WIRES

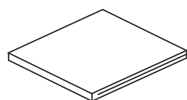

SIN 711-2

Model #	W	D	H	Wt	V
3 SHMN 1012	10.55	12	.75	2	0.2
3 SHMN 1112	11.25	12	.75	2.5	0.3
3 SHMN 1015	10.55	15	.75	3	0.3
3 SHMN 1115	11.25	15	.75	3	0.4

- Two outer bays require shelves to be 10.55"W
- Inner bays require shelves to be 11.25"W
- Shelves include 2 mounting wires
- If ordering for add-on to product ordered 2012 or earlier, please state on order

HPL \$ applies to tops only

ALL ITEMS (Except Tambour Door Base Cabinets) SHIP RTA

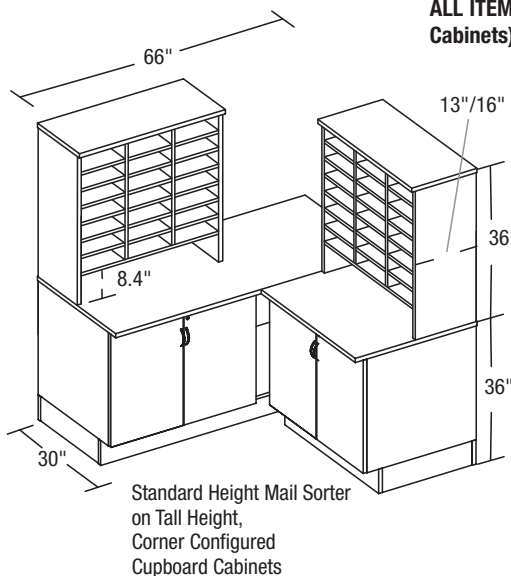
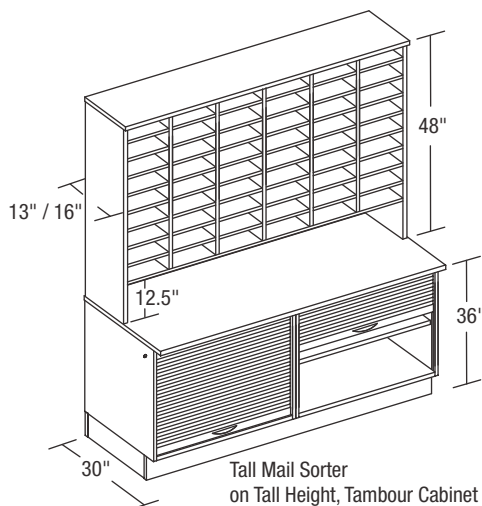

LEGEND: W=width; D=depth; H=height (inches); Wt=shipping weight (lbs); V=volume (cubic feet); TFL \$=thermally fused laminate \$; HPL \$= high pressure laminate \$

NOTES

SCREENS

A large grid of graph paper for taking notes, consisting of 20 columns and 30 rows of small squares.

fluid

concepts

Really cool workspaces

www.fluidgroup.com

www.inlinegroup.ca

sales@fluidgroup.com

T. 1.800.660.3516

