

Tables

Product Guide



Tables

Contents

Tables

Configuring and Reconfiguring “Facet” Meeting Tables (trêo®)	5-2
Configuring Trapezoids & Meeting Table Tops (trêo®)	5-3
Meeting Table Tops and Bases (for tops up to 108" wide) (trêo®)	5-5
Conference Table Tops (trêo®)	5-6
Conference Table Tops and Bases (for tops 120+" wide) (trêo®)	5-7
Metal Legs and Bases – Round Tube (trêo® and Boardwalk™)	5-8
Metal Legs and Bases – Rectangular Tube (trêo® and Boardwalk™)	5-9
Flipping and Folding Legs and Bases (trêo® and Boardwalk™)	5-10
Wood Bases (trêo®)	5-11
Wood Bases / Connecting Hardware (trêo®)	5-12
Adding Power to Training Tables	5-13
Configuring and Reconfiguring “Facet” Meeting Tables (Boardwalk™)	5-14
Configuring Trapezoids & Meeting Table Tops (Boardwalk™)	5-15
Meeting Table Tops and Bases (for tops up to 108" wide) (Boardwalk™)	5-17
Conference Table Tops (Boardwalk™)	5-18
Conference Table Tops and Bases (for tops 120+" wide)	5-19
Wood Bases (Boardwalk™)	5-20
Wood Bases / Connecting Hardware (Boardwalk™)	5-21
Smart Boardroom Tables	5-22



INDOOR AIR QUALITY
Indoor Advantage | Furniture

All products are SCS Indoor Advantage Certified except drum bases.

CONFIGURING AND RECONFIGURING "FACET" MEETING TABLES

SINGLE FACET TABLES

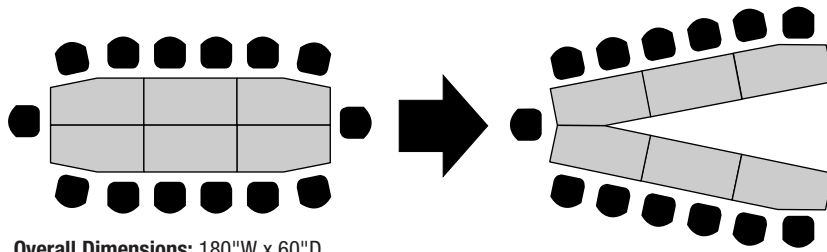

Overall Dimensions: 180"W x 60"D
Tops used: 3RS6030(2); 3RSF6030L(2); 3RSF6030R(2)
Sugg. bases: UTH20BL; UTHC20BL; UTMF24BL-W or UTCMF30BL-W

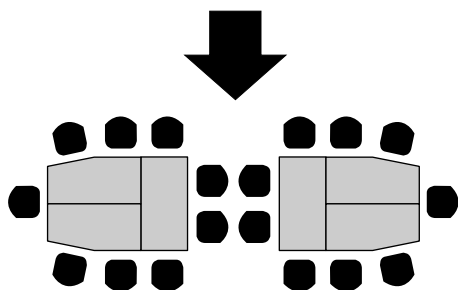
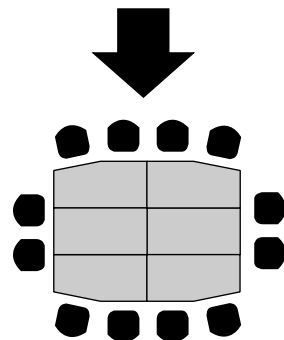
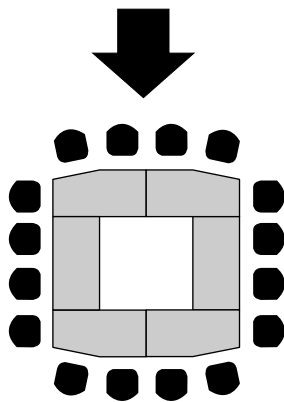

DOUBLE FACET TABLES

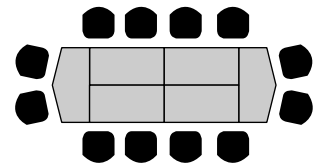

Overall Dimensions: 144"W x 48"D
Tops used: 3RS4824(4); 3RDF4824(2)
Sugg. bases: UTH20BL; UTHC20BL; UTMF24BL-N or UTCMF24BL-N

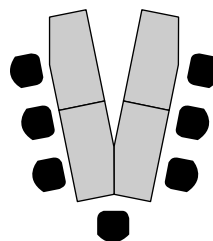
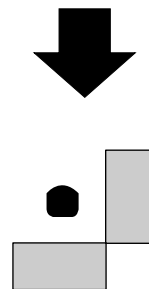
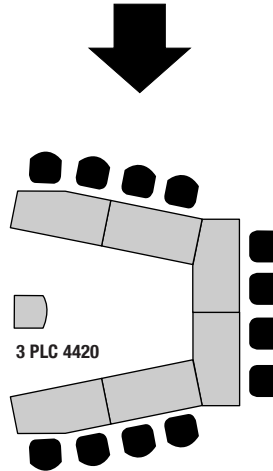
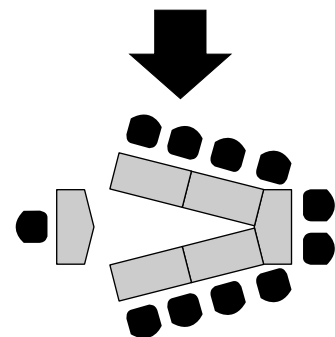
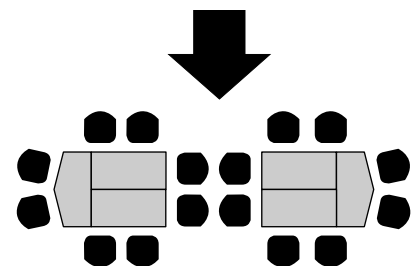
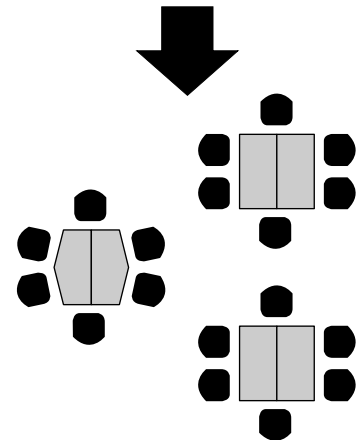
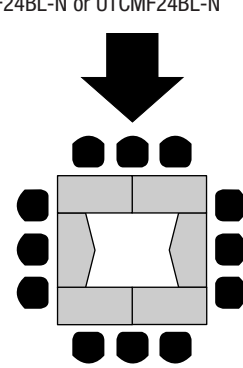

QUICK CONNECT HARDWARE - SEE PAGE 5-12

<p>QUICK RELEASE JOINERS</p> <p>TG 1000</p>	<p>OR</p>	<p>TABLE GANGING PLATE</p> <p>TG 10001</p>
--	------------------	---

LEGEND: W=width; D=depth (inches); Wt=shipping weight (lbs); V=volume (cubic feet); TFL \$=thermally fused laminate \$; HPL \$= high pressure laminate \$

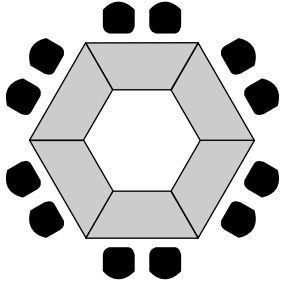

Overall Dimensions:
144"W x 125"D

Tops used: 3RZ723636(6)

Seating capacity: 12

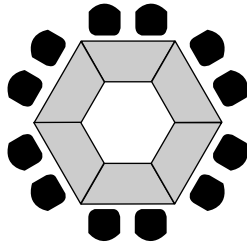

Overall Dimensions:
120"W x 104"D

Tops used: 3RZ603030(6)

Seating capacity: 12

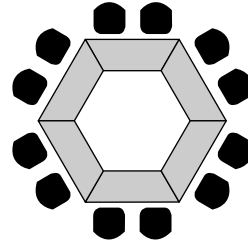

Overall Dimensions:
120"W x 104"D

Tops used: 3RZ602424(6)

Seating capacity: 12

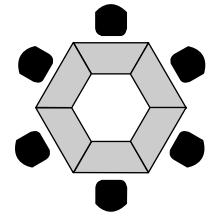

Overall Dimensions:
96"W x 83"D

Tops used: 3RZ482424(6)

Seating capacity: 6

Combine with Rectangular Tops

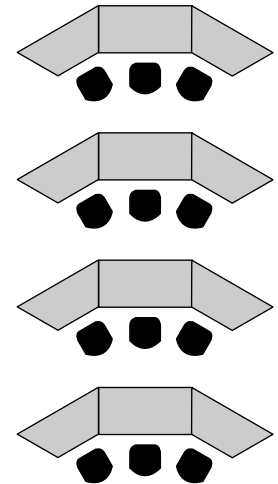
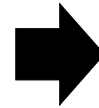
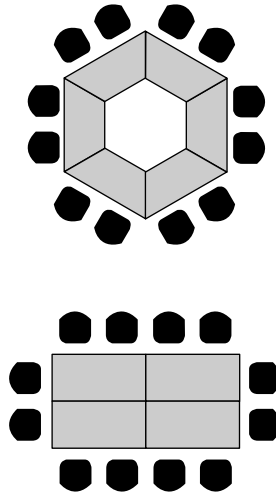
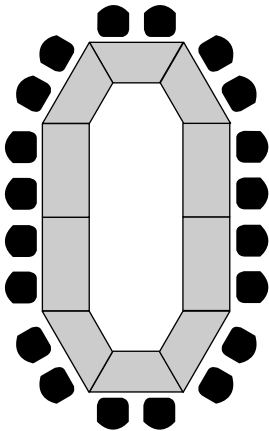

MEETING TABLE TOPS (trēo® – 1" thick tops)



HEXAGON TRAPEZOID TOP		Model #	A	B	C	D	Wt	V	TFL \$	HPL \$	Remarks
	48" x 24/24/24"	3 RZ 482424	48	24	24	21	21	2.4			<ul style="list-style-type: none"> Hexagon Trapezoid tops sized to form circular groups of six (6) tables. For octagon tables which form circular groups of eight (8), call factory for pricing 3 RZ 482424 should use ULP 2 post legs or UTHS 20 side-mount T-legs only (see note on pg. 5-9 for UTHS legs)
	60" x 24/36/24"	3 RZ 602436	60	24	36	21	27	3.0			
	60" x 30/30/30"	3 RZ 603030	60	30	30	26	33	3.6			
	72" x 36/36/36"	3 RZ 723636	72	35	37	30	45	4.3			
SINGLE FACET TOP											
	(Left) 60" x 30"	3 RSF 602430	60	24	30	30	45	3.6			
	(Right) 60" x 30"	3 RSF 603024	60	30	30	24	45	3.6			
DOUBLE FACET TOP											
	48" x 24"	3 RDF 4824	48	18	24	24	26	2.4			
	60" x 30"	3 RDF 6030	60	24	30	30	42	3.6			

All items SIN 711-11

LEGEND: W=width; D=depth (inches); Wt=shipping weight (lbs); V=volume (cubic feet); TFL \$=thermally fused laminate \$; HPL \$= high pressure laminate \$

MEETING TABLE TOPS (trēo® – 1" thick tops)

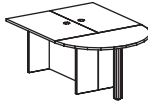
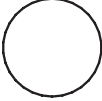

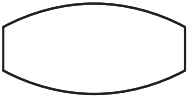
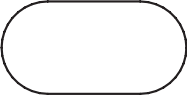
HALF ROUND TOP		Model #	W	D	Wt	V	TFL \$	HPL \$	Remarks
 SIN 711-11		48" 3 DDR 4824	48	24	23	1.6			<ul style="list-style-type: none"> • If stand-alone, use three ULP4BL, 4NI or 2NIT legs • Use with one ULP4BL when attaching to 2 returns as shown
		60" 3 DDR 6030	60	30	35	2.0			
ROUND TOP									
 SIN 711-11	24"	3 RR 24	24	24	11	0.9			<ul style="list-style-type: none"> • Use 4 post-legs or matching cross, spider, cube or drum bases on following pages • 60" uses 5 post-legs, 4 column spider base or wood cross base
	30"	3 RR 30	30	30	19	1.2			
	36"	3 RR 36	36	36	28	1.7			
	42"	3 RR 42	42	42	37	2.2			
	48"	3 RR 48	48	48	50	2.9			
	60"	3 RR 60	60	60	77	4.4			
SQUARE TOP									
 SIN 711-11	24" x 24"	3 RS 2424	24	24	15	0.9			<ul style="list-style-type: none"> • Use 4 post-legs, 2 t-legs or matching cross, spider, cube or drum bases on following pages
	30" x 30"	3 RS 3030	30	30	23	1.2			
	36" x 36"	3 RS 3636	36	36	34	1.7			
	42" x 42"	3 RS 4242	42	42	46	2.2			
	48" x 48"	3 RS 4848	48	48	60	2.9			
	60" x 60"	3 RS 6060	60	60	94	4.4			
RECTANGLE TOP									
	36" x 24"	3 RS 3624	36	24	23	1.7			<ul style="list-style-type: none"> • Tops up to 96" use (4) ULP4 Post Legs; (2) Bases suitable to the Top depth; or a panel base suitable to the length <div style="border: 1px solid black; padding: 5px; margin: 10px 0;"> For longer tops see Conference Table Section on page 5-6 </div> <ul style="list-style-type: none"> • Additional Meeting and Conference room furniture available on pg. 1-41
	42" x 24"	3 RS 4224	42	24	28	2.1			
	48" x 24"	3 RS 4824	48	24	30	2.4			
	54" x 24"	3 RS 5424	54	24	34	2.7			
	60" x 24"	3 RS 6024	60	24	38	3.0			
	66" x 24"	3 RS 6624	66	24	42	3.2			
	72" x 24"	3 RS 7224	72	24	45	3.5			
	42" x 30"	3 RS 4230	42	30	33	2.5			
	48" x 30"	3 RS 4830	48	30	38	2.9			
	54" x 30"	3 RS 5430	54	30	43	3.3			
	60" x 30"	3 RS 6030	60	30	47	3.6			
	66" x 30"	3 RS 6630	66	30	52	4.0			
	72" x 30"	3 RS 7230	72	30	56	4.3			
	84" x 30"	3 RS 8430	84	30	66	5.0			
	48" x 36"	3 RS 4836	48	36	45	3.5			
	60" x 36"	3 RS 6036	60	36	56	4.3			
	72" x 36"	3 RS 7236	72	36	68	5.1			
	84" x 36"	3 RS 8436	84	36	79	5.9			
	96" x 36"	3 RS 9636	96	36	90	6.7			
	72" x 42"	3 RS 7242	72	42	79	5.9			
84" x 42"	3 RS 8442	84	42	92	6.8				
96" x 42"	3 RS 9642	84	42	105	7.7				
96" x 48"	3 RS 9648	96	48	120	8.8				
108" x 48"	3 RS 10848	108	48	137	9.5				
BOAT-SHAPE TOP									
	1 Pc Top 72" x 36/28"	3 RB 7236	72	36	62	5.1			
	84" x 42/32"	3 RB 8442	84	42	83	6.8			
	96" x 42/32"	3 RB 9642	96	42	95	7.7			
	96" x 48/36"	3 RB 9648	96	48	107	8.8			
	108" x 48/36"	3 RB 10848	108	48	120	9.5			
RACETRACK TOP									
 All items SIN 711-11	1 Pc Top 72" x 36"	3 RT 7236	72	36	62	5.1			
	84" x 36"	3 RT 8436	84	36	73	5.9			
	84" x 42"	3 RT 8442	84	42	83	6.8			
	96" x 42"	3 RT 9642	96	42	95	7.7			
	96" x 48"	3 RT 9648	96	48	107	8.8			
	108" x 48"	3 RT 10848	108	48	120	9.5			



LEGEND: W=width; D=depth (inches); Wt=shipping weight (lbs); V=volume (cubic feet); TFL \$=thermally fused laminate \$; HPL \$= high pressure laminate \$

MEETING TABLE TOPS AND BASES (for tops up to 108" Wide)

TOPS		DDR	RR	RS (Square)	RZ	RSF & RDF	RS up to 84"W	RS 96" to 108"W	RT 96" to 108"W	RB 96" to 108"W	
BASES											
	ULP2BL ULP2NI	3 (f/s) or 1 (attached)	4	4	4	4	4 ≤ 60"W 5 ≥ 66"W	6	6	6	
	ULP4BL ULP4NI	3 (f/s) or 1 (attached)	4	4	4	4	4 ≤ 72"W 5 ≥ 78"W	5	4 ≤ 96"W 5 @ 108"W	4 ≤ 96"W 5 @ 108"W	
	UTM20BL UTH20BL UTS20BL	2 (f/s) or 1 (attached)	-	2 ≤ 30"W	2	2	2 ≤ 30"D	-	-	-	
	UTM30BL UTH30BL UTS30BL	-	-	2 ≥ 36"W	-	-	2 ≥ 36"D	2 ≥ 36"D	2 ≥ 36"D	2 ≥ 36"D	
	UXH24BL	-	1 ≤ 24" dia.	1 ≤ 24"W	-	-	2 ≤ 30"D	-	-	-	
	UXM28BL UXH28BL	-	1 ≤ 42" dia.	1 ≤ 42"W	-	-	2 ≤ 42"D	2 ≤ 42"D	2 ≤ 42"D	2 ≤ 42"D	
	UXM42BL UXH42BL	-	1 ≤ 48" dia.	1 ≤ 48"W	-	-	2 @ 48"D	2 @ 48"D	2 @ 48"D	2 @ 48"D	
	UXHQ42BL	-	1 @ 60" dia.	1 @ 60"W	-	-	-	-	-	-	
	UXW USW	-	1	1	-	-	2	2	2	2	
	UCW	-	1	1	-	-	2	2	2	2	
	UVW16	-	-	-	-	-	2 ≤ 36"D	2 ≤ 36"D	2 ≤ 36"D	2 ≤ 36"D	
	UVW20	-	-	-	-	-	2 ≥ 42"D	2 ≥ 42"D	2 ≥ 42"D	2 ≥ 42"D	
	UPW	-	-	-	-	-	1	1	1	1	
	UPWS	-	-	-	-	-	1	1	1	1	
	UDR18	-	1 ≤ 42" dia.	1 ≤ 42"W	-	-	2 ≤ 42"D	2 ≤ 42"D	2 ≤ 42"D	2 ≤ 42"D	
	UDR24	-	1 ≥ 48" dia.	1 ≥ 48"W	-	-	2 ≥ 48"D	2 ≥ 48"D	2 ≥ 48"D	2 ≥ 48"D	
	ULF24BL	-	-	-	4 @ 72"W only	-	4 ≥ 60"W	-	-	-	
	UTF24BL	-	-	-	-	-	2 ≥ 60"W	2 ≥ 60"W	2 ≥ 60"W	2 ≥ 60"W	
	UTMF24BL -N / W	-	-	-	1 ≤ 60 x 30	1	1 ≤ 72 x 30	-	-	-	
	UTCMF24 BL-N / W	-	4	4	1 ≤ 60 x 24	1 @ 48 x 24	1 ≤ 72 x 24	-	-	-	
	UTCMF30 BL-N / W	-	-	-	1 ≤ 60 x 30	1 @ 60 x 30	1 ≤ 72 x 30	-	-	-	

CONFERENCE TABLE TOPS (trēo® – 1" thick tops)

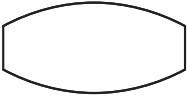

RECTANGLE TOP		Model #	# Sections	Wt	V	TFL \$	HPL \$	Remarks
 SIN 711-11	120" x 48"	3 RS 12048	2	155	11.2			<ul style="list-style-type: none"> • Woodgrains run lengthwise • 216"W tops are in 2 pcs. in TFL, but 3 pcs. in HPL • 120"W and 144"W tops in HPL can be made in one piece as a custom order. Add \$300 List and include "-1Pc" as suffix to product code. • Woodgrain laminate finishes will not align exactly where two tops join • Multiple piece tops use table-tightener clamps at joints • For longer tables, call factory for quote • 60"D not available in some HPL finishes (eg: Passion and Shadow Oak). All TFL finishes available. • Additional Meeting and Conference room furniture available on pg. 1-41
	144" x 48"	3 RS 14448	2	185	13.3			
	168" x 48"	3 RS 16848	2	215	15.1			
BOAT-SHAPE TOP								
 SIN 711-11	120" x 48/36"	3 RB 12048	2	136	11.2			
	144" x 48/36"	3 RB 14448	2	163	13.3			
	168" x 48/36"	3 RB 16848	2	189	15.1			
RACETRACK TOP								
 SIN 711-11	120" x 48"	3 RT 12048	2	125	11.2			
	144" x 48"	3 RT 14448	2	155	13.3			
	168" x 48"	3 RT 16848	2	185	15.1			
	144" x 60"	3 RT 14460	2	186	16.1			
	168" x 60"	3 RT 16860	2	224	18.8			
	180" x 60"	3 RT 18060	2	242	19.6			
	192" x 60"	3 RT 19260	2	261	21.5			
	216" x 60"	3 RT 21660	3	299	23.6			
VIDEO CONFERENCE TOP								
 SIN 711-11	96" x 48/36"	3 RV 9648	1	110	8.8			
	120" x 48/36"	3 RV 12048	2	136	11.2			
	144" x 48/36"	3 RV 14448	2	163	13.3			
	168" x 48/36"	3 RV 16848	2	189	15.1			
	144" x 60/45"	3 RV 14460	2	205	16.1			
	168" x 60/45"	3 RV 16860	2	238	18.8			
	180" x 60/45"	3 RV 18060	2	254	19.6			
	192" x 60/45"	3 RV 19260	2	271	21.5			
	216" x 60/45"	3 RV 21660	3	303	23.6			

LEGEND: W=width; D=depth (inches); Wt=shipping weight (lbs); V=volume (cubic feet); TFL \$=thermally fused laminate \$; HPL \$= high pressure laminate \$

CONFERENCE TABLE TOPS AND BASES (for tops 120+" Wide)

TOPS		RS 120"W+ (48"D)	RS 144"W+ (60"D)	RB 120"W+ (48"D)	RB 144"W+ (60"D)	RT 120"W+ (48"D)	RT 144"W+ (60"D)	RV 96"W+ (48"D)	RV 144"W+ (60"D)
BASES									
	ULP4BL ULP4NI	6 ≤ 168"W		6 ≤ 168"W		6 ≤ 168"W	6 ≤ 168"W 8 ≥ 180"W	-	-
	UTM30BL UTH30BL	3		3		3	-	-	-
	UTHD30BL	3		3		3	3 ≤ 180"W 4 ≥ 192"W	-	-
	UXM42BL UXH42BL	2 ≤ 144"W 3 @ 168"W		2 ≤ 144"W 3 @ 168"W		2 ≤ 144"W 3 @ 168"W	-	-	-
	UXHQ42BL	2 ≤ 144"W 3 @ 168"W		2 ≤ 144"W 3 @ 168"W		2 ≤ 144"W 3 @ 168"W	3 ≤ 192"W 4 ≥ 216"W	-	-
	UXW USW	2 @ 120"W 3 ≥ 144"W		2 @ 120"W 3 ≥ 144"W		2 @ 120"W 3 ≥ 144"W	3	-	-
	UCW	2 ≥ 120"W 3 @ 168"W		2 ≥ 120"W 3 @ 168"W		2 ≥ 120"W 3 @ 168"W	2 @ 144"W 3 ≥ 168"W	2 ≥ 120"W 3 @ 168"W	2 @ 144"W 3 ≥ 168"W
	UVW20	2 @ 120"W 3 @ 144"W 4 @ 168"W		2 @ 120"W 3 @ 144"W 4 @ 168"W		2 @ 120"W 3 @ 144"W 4 @ 168"W	-	-	-
	UPW+(D)	1		1		1	1(D)	1	1(D)
	UPWS+(D)	1		1		1	1(D)	1	1(D)
	UDR18	2 ≥ 120"W 3 ≥ 168"W		2 ≥ 120"W 3 ≥ 168"W		2 ≥ 120"W 3 ≥ 168"W	-	2 ≥ 96"W 3 ≥ 168"W	-
	UDR24	-		-		-	2 @ 144"W 3 ≥ 168"W	-	2 @ 144"W 3 ≥ 168"W

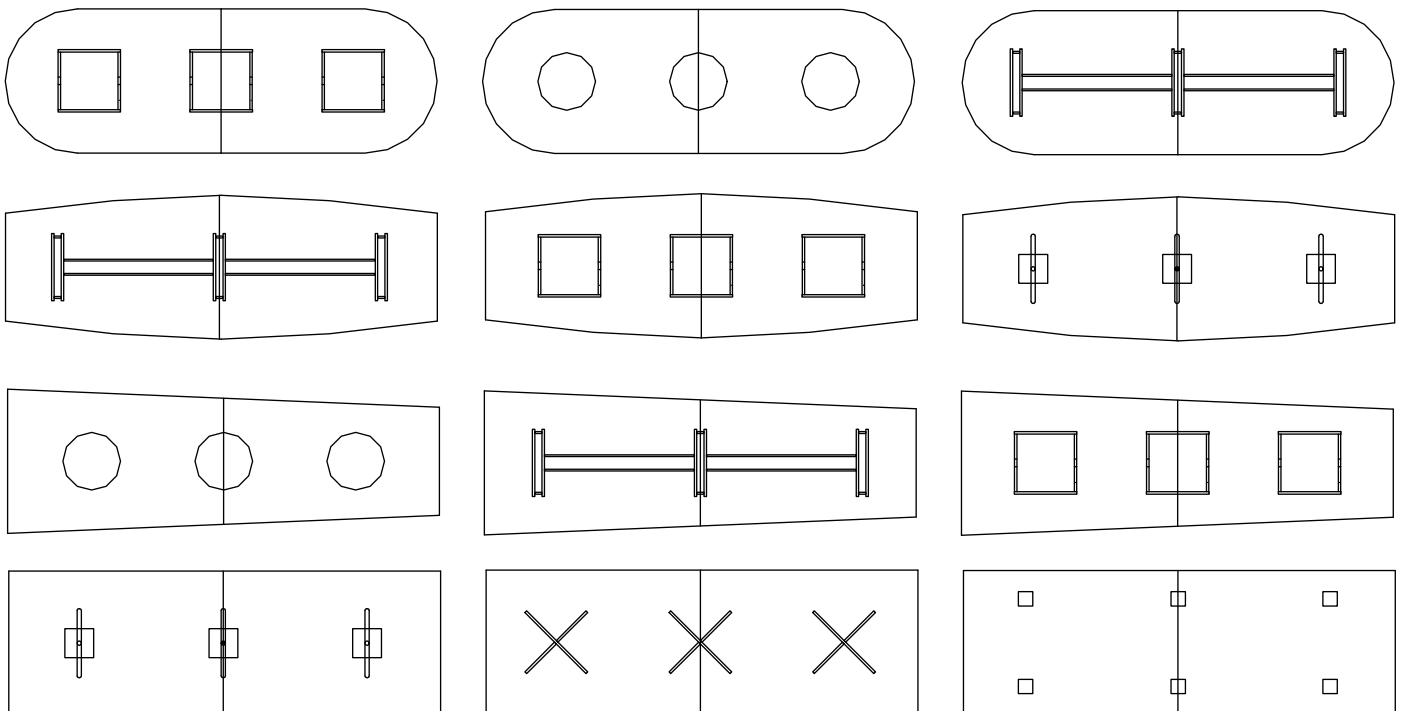

METAL LEGS & BASES – ROUND TUBE (trēo® and BOARDWALK™)

Tables

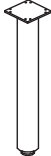
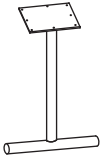
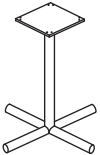
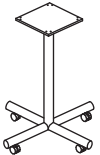
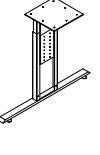
2.5" POST LEG		Model #	Drilling	W	D	H	Wt	V	\$ List	Remarks
 <p>SIN 711-11</p>	Black	ULP 2BL	(2P)	2.5	2.5	27.75	4	0.3		<ul style="list-style-type: none"> • Suitable for smaller Round, Square and Rectangular tables • 2 1/2" diameter • Leveler in base adjusts: 2" • Top plate of fixed is 6" x 6"; mobile is 4" x 4" • Mobile legs have locking 60mm casters
	Brushed Nickel	ULP 2NI	(2P)	2.5	2.5	27.75	4	0.3		
	Mobile Post Leg Black	ULPC 2BL	(2P)	2.5	2.5	27.75	4	0.3		
	Mobile Post Leg Nickel	ULPC 2NI	(2P)	2.5	2.5	27.75	4	0.3		
4" POST LEG										
 <p>SIN 711-11</p>	Black	ULP 4BL	(4P)	4	4	27.75	10	0.4		<ul style="list-style-type: none"> • Leveler in base adjusts: 2" • Top plate is 6" x 6" • Mobile legs have locking 60mm casters
	Brushed Nickel	ULP 4NI	(4P)	4	4	27.75	10	0.4		
	Mobile Post Leg Black	ULPC 4BL	(4P)	4	4	27.75	10	0.4		
METAL "T" BASE – ROUND TUBE										
 <p>SIN 711-11</p>	Table Depths 24", 30"	UTM 20 BL (20TM)	*	20	27.75	12	4.3			<ul style="list-style-type: none"> • Black only • Top plate is 12" x 12" • Welded steel tube • Round tube bases can be customized to have casters at same height. Call factory for quote.
	36", 42", 48"	UTM 30 BL (30TM)	**	28	27.75	17	6.2			
SPIDER BASE – ROUND TUBE										
 <p>SIN 711-11</p>	Table Depths 30", 36", 42"	UXM 28 BL (28XM)	*	28	27.75	17	12.6			<ul style="list-style-type: none"> • Black only • Welded steel tube • Top plate is 12" x 12"
	48"	UXM 42 BL (42XM)	**	42	27.75	26	26.5			
SPIDER BASE WITH CASTERS – ROUND TUBE										
 <p>SIN 711-11</p>	Table Depths 30", 36", 42"	UXMC 28 BL (28XMC)	*	28	27.75	18	12.6			<ul style="list-style-type: none"> • Black only • Top plate is 12" x 12"
INCREMENTAL HEIGHT "T" LEG										
 <p>SIN 711-11</p>	Table Depths 18"	UTHIH-16 (16TM)	*	16			19	3.6		<ul style="list-style-type: none"> • Black only • Top plate is 12" x 12" • Height adjustable 24"H to 32"H
	24", 30"	UTHIH-20 (20TM)	*	20			21	4.3		
	36", 42", 48"	UTHIH-30 (30TM)	*	28			26	6.2		

LEGEND: W=width; D=depth; H=height (inches); Wt=shipping weight (lbs); V=volume (cubic feet)

METAL LEGS & BASES – RECTANGULAR TUBE (trēo® and BOARDWALK™)

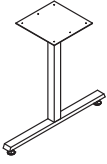
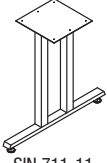
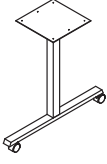
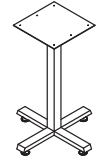
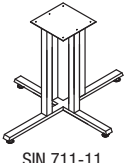
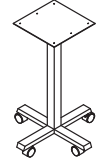

Tables

METAL "T" BASE – RECTANGULAR TUBE		Model #	Drilling	W	D	H	Wt	V	\$ List	Remarks	
 <p>SIN 711-11</p>	Table Depths 24", 30" 36", 42", 48"	UTH 20 BL UTH 30 BL	(20TM) (30TM)	2 2	20 28	27.75 27.75	12 17	4.3 6.2	<ul style="list-style-type: none"> • Black is standard, other finishes available with surcharges (call factory). • Top plate is 12" x 12" • Welded steel tube • For "side-mount" T-legs with leg at edge of mounting plate, add "S" to code. e.g. UTH becomes UTHS. Add \$10 List per base. 		
	DOUBLE-T BASE – RECTANGULAR TUBE										
 <p>SIN 711-11</p>	Table Depths 24", 30" 36", 42", 48"	UTHD 20 BL UTHD 30 BL	(20TM) (30TM)	2 2	20 28	27.75 27.75	17 22	4.3 6.2	<ul style="list-style-type: none"> • As above • Linear spread between uprights is 5.25", to outside of uprights is 9.25" 		
	"T" BASE WITH CASTERS – RECTANGULAR TUBE										
 <p>SIN 711-11</p>	Table Depths 24", 30" 36", 42", 48"	UTHC 20 BL UTHC 30 BL	(20TM) (30TM)	2 2	20 28	27.75 27.75	12 17	4.3 6.2	<ul style="list-style-type: none"> • As above 		
	SPIDER BASE – RECTANGULAR TUBE										
 <p>SIN 711-11</p>	Table Depths 24" 30", 36", 42" 48"	UXH 24 BL UXH 28 BL UXH 42 BL	(24XM) (28XM) (42XM)	2 2 2	24 28 42	27.75 27.75 27.75	16 17 26	10.8 12.6 26.5	<ul style="list-style-type: none"> • As above 		
	Bar Height 24" 30"	UXH 2441 BL UXH 2841 BL	(24XM) (28XM)	2 2	24 28	41 41	18 19	16 21.4			
	4 COLUMN SPIDER BASE – RECTANGULAR TUBE										
	Table Depths 30", 36", 42" 48", 60"	UXHQ 28 BL UXHQ 42 BL	(28XM) (42XM)	2 2	28 42	27.75 27.75	32 41	12.6 26.5		<ul style="list-style-type: none"> • As above • Linear spread between uprights is 5.25", to outside of uprights is 9.25" • Corner to corner spread is 2.5" 	
	SPIDER BASE W/ CASTERS – RECTANGULAR TUBE										
 <p>SIN 711-11</p>	Table Depths 30", 36", 42" 48"	UXHC 28 BL UXHC 42 BL	(28XM) (42XM)	2 2	28 42	27.75 27.75	18 27	12.6 26.5	<ul style="list-style-type: none"> • As above 		
	4 COLUMN MOBILE SPIDER BASE – RECT. TUBE										
 <p>SIN 711-11</p>	Table Depths 30", 36", 42" 48", 60"	UXHQC 28 BL UXHQC 42 BL	(28XM) (42XM)	2 2	28 42	27.75 27.75	33 42	12.6 26.5	<ul style="list-style-type: none"> • As above • Linear spread between uprights is 5.25", to outside of uprights is 9.25" • Corner to corner spread is 2.5" 		

LEGEND: W=width; D=depth; H=height (inches); Wt=shipping weight (lbs); V=volume (cubic feet)

FLIPPING & FOLDING LEGS & BASES (trēo® and BOARDWALK™)

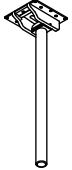
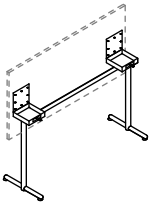
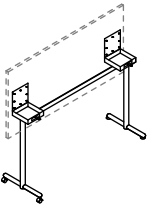
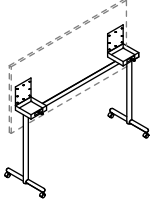
Tables

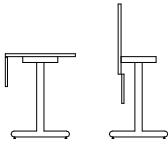
FOLDING T-LEGS		Model #	Drilling	W	D	H	Wt	V	\$ List	Remarks
 SIN 711-11	Table Depth up to 36"	UTF 24BL	(24FO)	1.5	24	27	30	2.8	(pair)	<ul style="list-style-type: none"> • Legs have 1" levelling capability • Black legs only, silver folding hardware
FOLDING POST LEGS										
 SIN 711-11	Table Depth up to 48"	ULF 24BL	(FP)	2	2	27.75	4.5	0.5		<ul style="list-style-type: none"> • Positive lock in both folded and upright positions • Legs have 1" levelling capability • Legs in folded position add 3.5" to table thickness • Black is standard, other finishes available with surcharges (call factory).
FLIPPING TABLE BASE										
 SIN 711-11	Table Widths 36" to 54" 60" to 72"	UTMF 24BL-N UTMF 24BL-W	(54FP) (72FP)	34 58	24 24	27.75 27.75	29 30	4.3 4.5		<ul style="list-style-type: none"> • Locks in both horizontal and vertical positions • Legs have 1" levelling capability • Ships as pair of legs and bolt-on stretcher RTA • Black is standard, other finishes available with surcharges (call factory).
MOBILE FLIPPING TABLE BASE										
 SIN 711-11	Table Widths – 24"D 36" to 54" 60" to 72" Table Widths – 30"D 36" to 54" 60" to 72"	UTCMF 24BL-N UTCMF 24BL-W UTCMF 30BL-N UTCMF 30BL-W	(54FP) (72FP) (54FP) (72FP)	34 58 34 58	24 24 30 30	27.75 27.75 27.75 27.75	29 30 39 40	4.3 4.5 6.2 6.4		<ul style="list-style-type: none"> • Locks in both horizontal and vertical positions • Base has 2 locking casters for wheelbarrow mobility • Also available in fully mobile version (see below). Add "M" to end of model number; add \$37 List • Ships as pair of legs and bolt-on stretcher RTA • Black is standard, other finishes available with surcharges (call factory).
										
HINGED MODESTY FOR FLIP TOP TABLES										
 SIN 711-11		3 HM 3610 3 HM 4210 3 HM 4810 3 HM 5410 3 HM 6010 3 HM 6610 3 HM 7210		36 42 48 54 60 66 72	.75 .75 .75 .75 .75 .75 .75	10 10 10 10 10 10 10	9 10 11 13 14 16 17	.7 .8 .9 1.0 1.1 1.2 1.3		<ul style="list-style-type: none"> • 3/4" TFL construction • Modesty sized to width of table top • Hinged to automatically fold flat when table is flipped up • Rubber sweep at top of modesty for wire access • Not recommended for tables over 30"D
										

LEGEND: W=width; D=depth; H=height (inches); Wt=shipping weight (lbs); V=volume (cubic feet)

TABLES

WOOD BASES (tréo®)

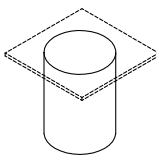
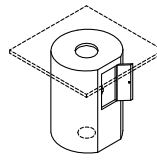
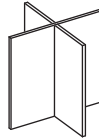
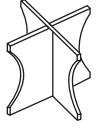
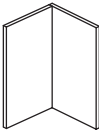
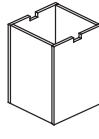
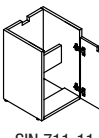

SINGLE PANEL BASE		Model #	Drilling	W	D	H	Wt	V	\$ List	Remarks	
 SIN 711-11	Round Table Depths 30", 36", 42"	UDR 18	(UD18)	18	18	28	62	6.0		<ul style="list-style-type: none"> • Wood construction wrapped with HPL (specify finish) • Large wood top plate is pre-drilled to attach to table tops • Drum bases require 125 lbs. of sand in each for stability. Sand is not included. 	
	48"	UDR 24	(UD24)	24	24	28	76	8.7			
	Rectangular Table Depths 30", 36", 42", 48"	UDR 18	(UD18)	18	18	28	62	6.0			
	60"	UDR 24	(UD24)	24	24	28	76	8.7			
DRUM BASE WITH ACCESS DOOR											
 SIN 711-11	Round Table Depths 30", 36", 42"	UDRW 18	(UD18)	18	18	28	62	6.0			<ul style="list-style-type: none"> • Size and construction details as above • Access door is 9"W x 12"H, opens with a finger press • Wire access pass-through in top and bottom of base • Add any power/data grommet, see page 7-7 • Drum bases require 125 lbs. of sand in each for stability. Sand is not included.
	48"	UDRW 24	(UD24)	24	24	28	76	8.7			
	Rectangular Table Depths 30", 36", 42", 48"	UDRW 18	(UD18)	18	18	28	62	6.0			
	60"	UDRW 24	(UD24)	24	24	28	76	8.7			
CROSS BASE – WOOD											
 SIN 711-11	Table Depths 30"	3 UXW 30	(X30)	20	20	27.75	28	1.7		<ul style="list-style-type: none"> • Match to diameter or depth of table top • 1" thick TFL construction 	
	36"	3 UXW 36	(X36)	24	24	27.75	34	1.9			
	42"	3 UXW 42	(X42)	30	30	27.75	43	2.4			
	48"	3 UXW 48	(X48)	33	33	27.75	48	2.6			
	60"	3 UXW 60	(X60)	42	42	27.75	61	3.2			
SCALLOPED CROSS BASE											
 SIN 711-11	Table Depths 30"	3 USW 30	(X30)	20	20	27.75	25	1.7		<ul style="list-style-type: none"> • Match to diameter or depth of table top • 1" thick TFL construction 	
	36"	3 USW 36	(X36)	24	24	27.75	31	1.9			
	42"	3 USW 42	(X42)	30	30	27.75	40	2.4			
	48"	3 USW 48	(X48)	33	33	27.75	45	2.6			
	60"	3 USW 60	(X60)	42	42	27.75	58	3.2			
"V" BASE											
 SIN 711-11	Table Depths 30", 36"	3 UVW 1616	(V16)	16	16	27.75	23	1.4		<ul style="list-style-type: none"> • 1" thick TFL construction 	
	42", 48"	3 UVW 2020	(V20)	20	20	27.75	28	1.7			
CUBE BASE											
 SIN 711-11	Table Depths 36"	3 UCW 36	(C36)	16	16	27.75	44	1.7		<ul style="list-style-type: none"> • Tables 120" and 144"W with 2 cubes or drums get reinforcing bar • 1" thick TFL construction only • Match base to table depths as shown • Two sides have 1.5"H x 3.25"W wiring cut-outs at top 	
	42"	3 UCW 42	(C42)	18	18	27.75	50	1.9			
	48"	3 UCW 48	(C48)	20	20	27.75	55	2.1			
	60"	3 UCW 60	(C60)	26	26	27.75	73	2.6			
CUBE BASES WITH ACCESS DOOR											
 SIN 711-11	Table Depths 36"	3 UCW 36D	(C36)	16	16	27.75	48	1.7			<ul style="list-style-type: none"> • 1" thick TFL construction only • Match base to table depths as shown • Two sides have 1.5"H x 3.25"W wiring cut-outs at top
	42"	3 UCW 42D	(C42)	18	18	27.75	54	1.9			
	48"	3 UCW 48D	(C48)	20	20	27.75	59	2.1			
	60"	3 UCW 60D	(C60)	26	26	27.75	77	2.6			

LEGEND: W=width; D=depth; H=height (inches); Wt=shipping weight (lbs); V=volume (cubic feet); TFL \$=thermally fused laminate \$

WOOD BASES / CONNECTING HARDWARE (trēo®)



SINGLE PANEL BASE		Model #	Drilling	W	D	H	Wt	V	\$ List	Remarks
	Table Lengths									<ul style="list-style-type: none"> • End panels are 1" thick TFL • Modesty panel is 3/4" thick TFL and is slightly off center to permit power / data port installation • Use on Rectangular, Race Track, Boat Shaped or Teleconference tops • Middle leg on Double Base has 1.5"H x 5.25"W wire pass-through
	72"	3 UPW 72	(P72)	37	20	27.75	43	3.2		
	84"	3 UPW 84	(P84)	43	20	27.75	44	3.4		
	96"	3 UPW 96	(P96)	53	24	27.75	52	4.0		
108"	3 UPW 108	(P108)	62	24	27.75	86	4.2			
DOUBLE PANEL BASE: 48"D TABLES										
	Table Lengths									
	120"	3 UPW 120	(P120)	80	24	27.75	72	5.4		
	144"	3 UPW 144	(P144)	104	24	27.75	78	5.9		
	168"	3 UPW 168	(P168)	128	24	27.75	82	6.3		
SINGLE SANDWICH PANEL BASE										
	Table Lengths									
	72"	3 UPWS 72	(P72)	37	20	27.75	88	8.8		
	84"	3 UPWS 84	(P84)	43	20	27.75	91	9.1		
	96"	3 UPWS 96	(P96)	53	24	27.75	107	10.7		
108"	3 UPWS 108	(P108)	62	24	27.75	120	11.1			
DOUBLE SANDWICH PANEL BASE: 48"D TABLES										
	Table Lengths @ 48"D									
	120"	3 UPWS 120	(P120)	80	24	27.75	160	14.5		
	144"	3 UPWS 144	(P144)	104	24	27.75	171	15.6		
	168"	3 UPWS 168	(P168)	128	24	27.75	179	16.7		
DOUBLE PANEL BASE: 60"D TABLES										
	Table Lengths @ 60"D									
	144"	3 UPW 144D	(P144D)	104	30	27.75	96	6.8		
	168"	3 UPW 168D	(P168D)	128	30	27.75	100	7.3		
	180"	3 UPW 180D	(P180D)	140	30	27.75	112	8.9		
	192"	3 UPW 192D	(P192D)	152	30	27.75	115	9.2		
DOUBLE SANDWICH PANEL BASE: 60"D TABLES										
	Table Lengths @ 60"D									
	144"	3 UPWS 144D	(P144D)	104	30	27.75	228	18.4		
	168"	3 UPWS 168D	(P168D)	128	30	27.75	244	19.5		
	180"	3 UPWS 180D	(P180D)	140	30	27.75	252	20.5		
	192"	3 UPWS 192D	(P192D)	152	30	27.75	260	21.6		
	216"	3 UPWS 216D	(P216D)	168	30	27.75	328	23.9		
QUICK RELEASE JOINERS (PAIR)										
		TG 1000		6	2.5					
TABLE GANGING PLATE										
		TG 1001		12	4					
All SIN 711-11										

LEGEND: W=width; D=depth; H=height (inches); Wt=shipping weight (lbs); V=volume (cubic feet); TFL \$=thermally fused laminate \$; HPL \$= high pressure laminate \$

Mobile Training Tables

Table Components

Item	Model	Qty
Table Top 60" x 30"	3 RS 6030	2
Mobile Flipping Base	UTCMF 30BL-W	2

Electrical Components

Item	Model	Qty
Duplex Block (installed)	ELD22WKTB	2
Plug-in Starter Cable	ELDSP72	1
Linking Cable	ELDL60	1*

*2 shown to illustrate connectivity

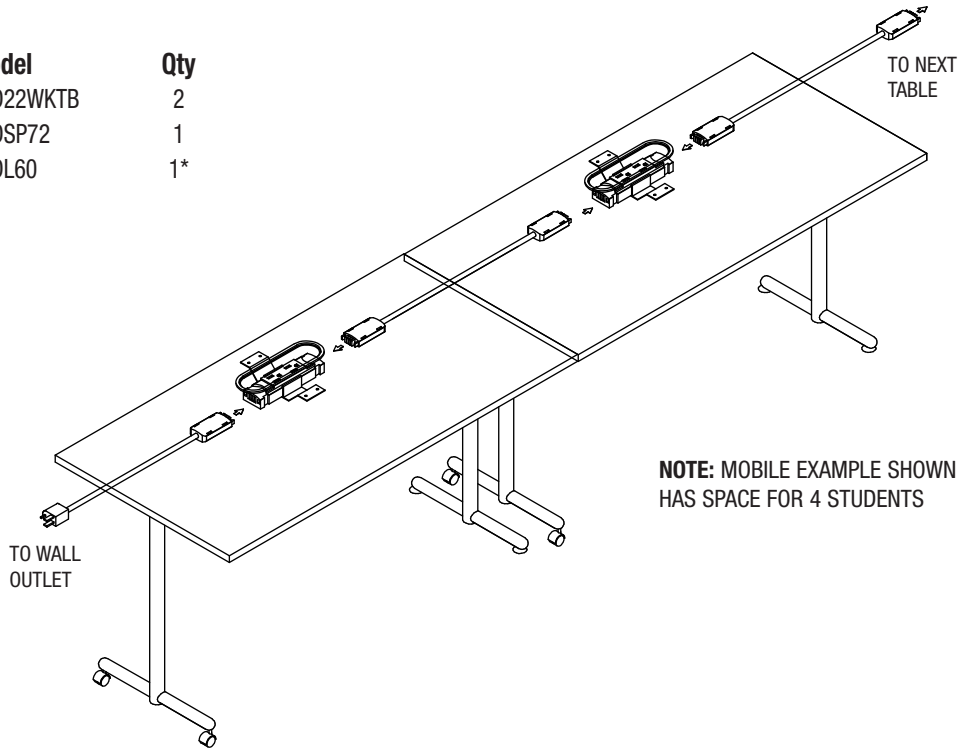

Fixed Training Tables

(See Stages® page 6-16)

Table Components

Item	Model	Qty
Training Table 72" x 24"	3 RL 7224	1
Training Table 36" x 24"	3 RL 3624	1

Electrical Components

Item	Model	Qty
Duplex Block	ELD22	3
Duplex Block Connector	ELDCN	1
Plug-in Starter Cable	ELDSP72	1
Linking Cable	ELDL66	1

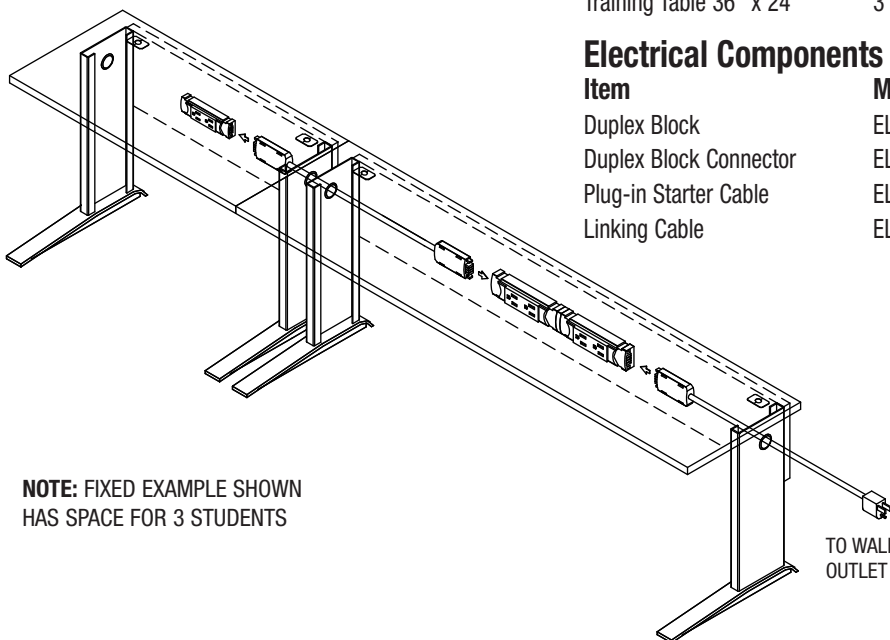

fluid

concepts

Really cool workspaces

www.fluidgroup.com
 www.inlinegroup.ca
 sales@fluidgroup.com
 T. 1.800.660.3516



Standard Laminate Finishes

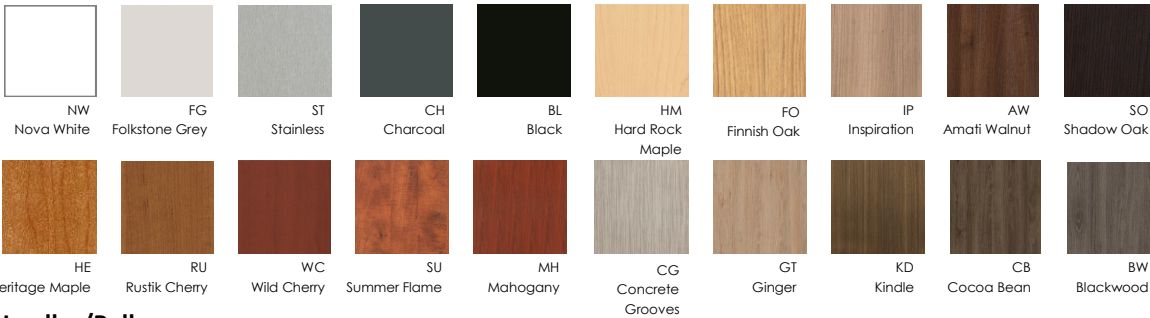

Handles/Pulls

