

Lockers

Product Guide



Lockers



FCLSD
Single Locker

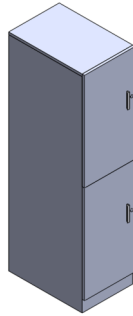

FCLDD
Double Locker



FCLQD
Quad Locker

Cubby Lockers



FCLCS
Single Width Cubby
Locker

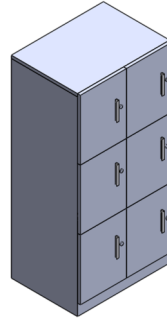

FCLCD
Double Width Cubby
Locker

Surfaces

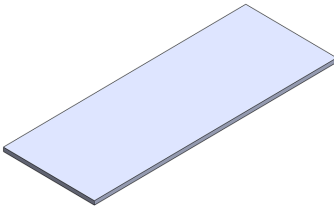

FCLWS
Common Top

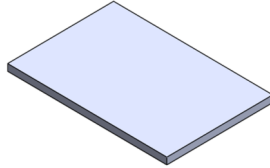

FCLAS
Additional Shelf

Accessories

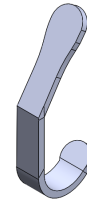

FCLHOOK
Hook

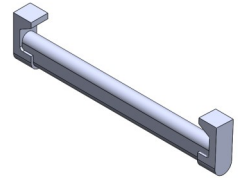

FCLROD
Coat Rod

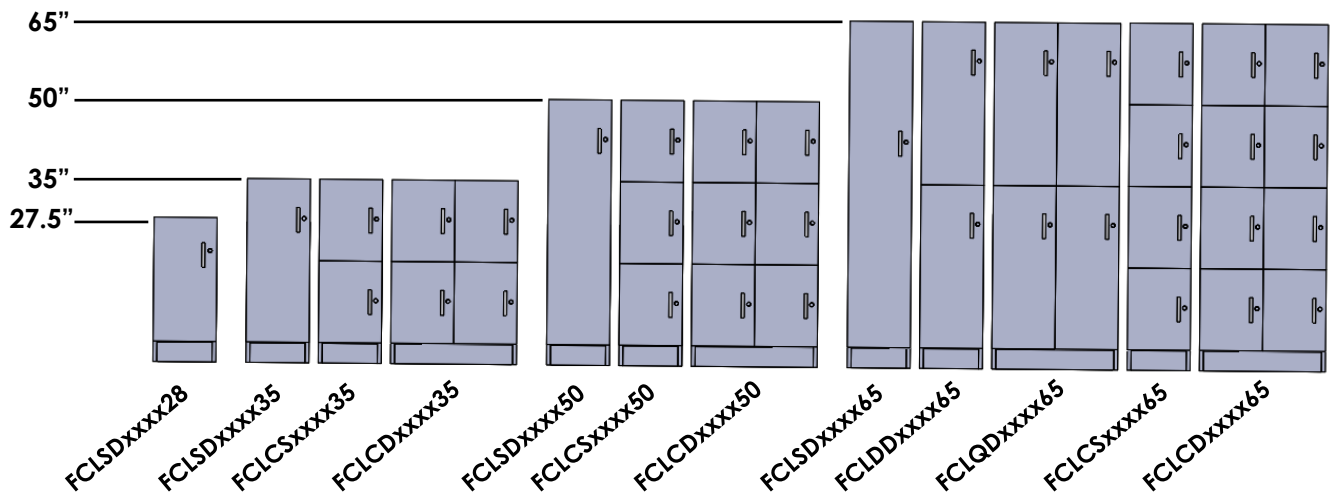

Finishes

Please see <https://www.fluidconcepts.ca/Furniture-Finishes-s/46.htm>

Base Finish - Your choice of Grade 1 laminate finishes. A "B" is placed in front of the laminate code to indicate it is the choice for the base of the locker.

Example **BFG** for a Folkstone Grey base.

Front Finish - Your choice of Grade 1 or Grade 2 laminate finishes. A "C" is placed in front of the laminate code to indicate it is the choice for the Front of the locker.

Example **CSW** for a Silverwood Front.

Common Top - Your choice of Grade 1 or Grade 2 laminate finishes. A "T" is placed in front of the laminate code to indicate it is the choice for the common top.

Example **TNW** for a Nova White Common Top.

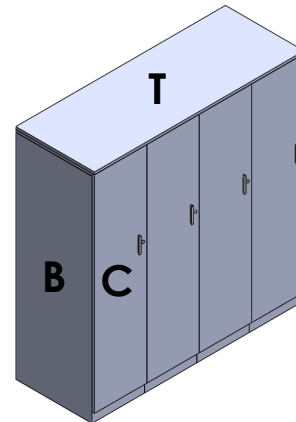
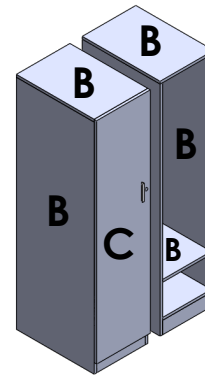

Storage legend

C - Front

B -Base

T - Common Top

Examples

Base = **BFG**, Folkstone Grey

Front = **CSW**, Silverwood

Common Top=**TNW**, Nova White

Features

- Full and half height lockers come with one 2 prong hook. An additional hook can be purchased separately. Alternatively, a coat rod can be ordered if required.
- Full and half height lockers come with shelf hole patterns at top and bottom of unit. This allows the user to change the shelf location based on their needs. One shelf is included with all full and half height lockers. Additional shelves can be ordered.
- Levelling glides are included which provide 3/4" of levelling.

Construction

- Lockers are constructed from 3/4" thick laminate. The Base is constructed from Thermofused Laminate, while a choice of Thermofused or High Pressure Laminate is available for the fronts and common tops.
- Door hinges allow for 109 degree opening.
- Lockers have the ability to gang together. Ganging hardware must be ordered.
- All units have a 3" kick plate.
- Locker and Cubby Locker units ship assembled.

Handle Style Codes



BX1 - Box Handle



LP1 - Medium Loop



ELL - Electronic Lock
Add \$440.00 List Per Front

Options

- Two standard handles are available. An electronic lock is available at an upcharge of \$440 list per front.
- 21 Standard laminates are available to choose from.
- The locker Base and Front can be ordered in different finishes. Please see How To Specify section on pages 8/9.
- Common top are available.
- Number plates, additional hooks, additional shelves and a coat rod are all available as addons.
- Lockers can be keyed alike or random. Please see key alike ordering page. Additionally, master and change keys are available for facilities purposes.
- Lockers can be specified as hinging on the left or right. They can also be ordered without fronts.







Left hinge location



Right hinge location

Keys

While each locker with a traditional lock comes with a key, additional keys can be purchased for extra convenience or facilities reasons. A master key will allow management to access any locker. A change key will help remove a lock core in order to change out the lock.

	Product Code	Product Description	List
	1 KEY2	Set of 2 Keys	\$
	1 LKEY2	Set of 2 Keys and Lock Core	\$
	1 CHKEY1	Change Key	\$
	1 MKEY1	Master Key	\$

Ganging

Ganging hardware can be ordered to attach each locker to its neighbor. This is done one site. It is recommended that the lockers be properly leveled before ganging hardware is attached. Locker have 3/4" of levelling. Rather than wood screws, male/female bolt connections are provided to assist in lining lockers up. One Set will connect two lockers together. Four sets would be needed to connect 5 lockers together.

Product Code	Product Description	List
1GANG1	Ganging Hardware Set	\$

Number Plates

Number plates are available for purchase. The plates are attached with adhesive tape and installed in the field. Numbers will be assigned based on the quantity ordered, starting with the number 1. If 15 plates are ordered, you will receive numbers 1 thru 15. For special requests please contact the factory for assistance.

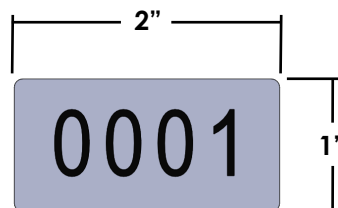

Electronic Locks

- Three user modes:
 - **Resident Employee.** A user is assigned a locker. Can be assigned by default admin code or by e mail via the smartphone app.
 - **Shared Use (Hotelling).** Any free locker can be used. Any code to lock, same code to unlock. Code is then erased and unit is ready for the next user.
 - **Multi User.** In Resident Employee mode, additional users can be added. Each user is separately identified with their own code for added security.
- Administration of Electronic Locks through smartphone app. Locks can be configured onsite by Administration.
- Change user code or enter programme mode with admin code on keypad or smartphone app.
- Administrative functions include:
 - Unlock and lock any electronic lock with one click.
 - Discover and reset lost passcodes.
 - Assign, delete and manage users.
 - Access history log.
- Green / Yellow / Red LED light system to identify lock status.
- External Micro-B USB for charging or emergency power.
- A 10 port charger is available for multi unit charging.
- User access through keypad or smartphone app.
- To specify an electronic lock see page 8 and 9.
- Handle style code: **ELL**
- Add **\$440 list (per front)** to Locker or Cubby list price.

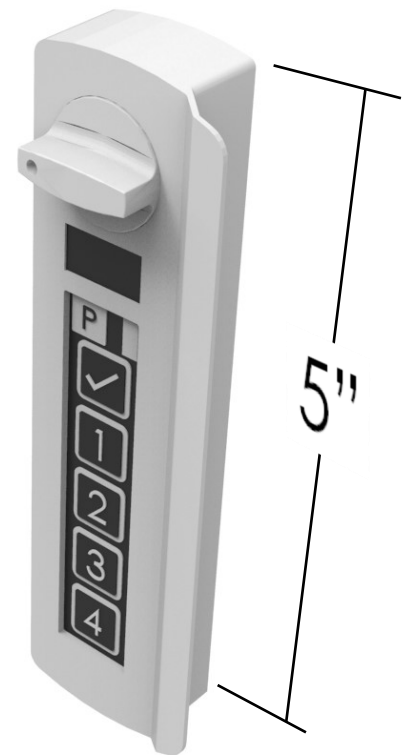

Electronic Lock Charging Kits

Mobile Charging Kit - ELLCRG

- 10 Port mobile charging kit.
- Contains a base station and 10 USB power banks.
- Base station will charge power banks.
- Each power bank can then charge one lock via USB.

Wired Charging Kit - ELLCRGW

- 10 Port wired charging kit.
- Contains a base station and ten 6-foot USB Cables.
- Base station is brought to locks and connected to building power.
- Locks are charged by base station via USB cables.

Product Code	Product Description	List
ELLCRG	10 Port Mobile Electronic Lock Charge Kit - With Power Banks	\$
ELLCRGW	10 Port Wired Electronic Lock Charge Kit	\$



A key-alike request can be made in order to group a series of lockers together which can be controlled with one key. Please submit this form with your purchase order. In addition to key-alike information, this form can be used to purchase additional Master Keys, Core Removal Keys and Cores. The key tagging information will allow you to have keys and cores grouped by floor, area, cluster ect.

Job Information

Your PO# _____
 PO Date _____
 Job Tag _____

Customer Information

Company _____
 Contact Name _____
 Contact Phone _____
 Contact E mail _____
 Address _____
 City _____
 State _____ ZIP _____

Shipping Information

Company _____
 Contact Name _____
 Contact Phone _____
 Address _____
 City _____
 State _____ ZIP _____

Handle Type

Box (BX1)
 Medium Loop (LP1)
 Electronic

Additional Keys

Master Key - 1 MKEY1 - \$ List ea
 QTY _____
 Change Key - 1 CHKEY1- \$ List ea
 QTY _____

Key Alike Information

_____ Sets of _____ Keyed alike keys.	_____ Sets of _____ Keyed alike keys.
_____ Sets of _____ Keyed alike keys.	_____ Sets of _____ Keyed alike keys.
_____ Sets of _____ Keyed alike keys.	_____ Sets of _____ Keyed alike keys.
_____ Sets of _____ Keyed alike keys.	_____ Sets of _____ Keyed alike keys.

Key Tagging

Qty of Keys/Cores	Key Alike or Random	Tagging Information

Lockers and Cubby Lockers

In order to properly specify a locker, five pieces of information are required. The Locker code, Hinge location, Base finish, Front finish and Handle Choice must be provided.

Locker Code - Please select your chosen style of locker.

Hinge location - Your choice of hinge on the left (**L**) or the right (**R**) hand side of the door.
If the without fronts option is required, use code (**NF**)

Base Finish - Your choice of Grade 1 laminate finishes. A "B" is placed in front of the laminate code to indicate it is the choice for the base of the locker. Example **BFG** for a Folkstone Grey base.

Front Finish - Your choice of Grade 1 or Grade 2 laminate finishes. A "C" is placed in front of the laminate code to indicate it is the choice for the Front of the locker. Example **CSW** for a Silverwood Front. NOTE: if the without fronts option was chosen, a Front Finish is not required.

Handle Choice - Please select your chosen style of handle and lock. **BX1** Box Handle, **LP1** Medium Loop or **ELL** Electronic Lock. NOTE: if the without fronts option was chosen, a Handle Choice is not required.

Common Tops

Top Finish - Your choice of Grade 1 or Grade 2 laminate finishes. A "T" is placed in front of the laminate code to indicate it is the choice for the common top. Example **TNW** for a Nova White Common Top.

Additional Shelves

Base Finish - Your choice of Grade 1 laminate finishes. A "B" is placed in front of the laminate code to indicate it is the choice for the base of the locker. Example **BFG** for a Folkstone Grey base.

Key Alike

Please see "Key Alike" form on page 7. Form is to be submitted with your purchase order. Information on lock core Change Keys as well as Master Keys is also found on page 7.

Example Codes

Single Locker - Hinge on left side, Base TFL laminate, Front TFL Laminate, Box handle.

FCLSD161865/L/BNW/CBW/BX1

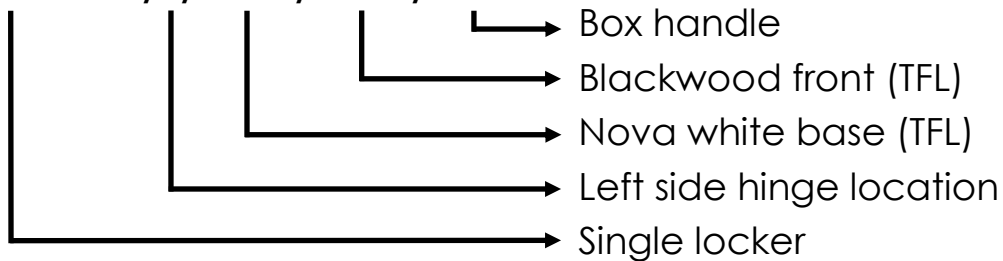

Double Width Cubby - Hinge on right side, Base TFL laminate, Front **HPL** Laminate, **Electronic lock**.

FCLCD241850/R/BCG/CHPNW/ELL

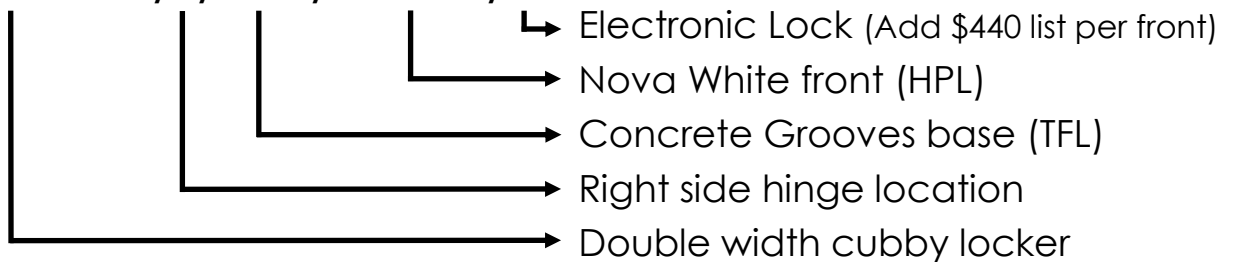

Quad locker - **Without Fronts**, Base TFL laminate, Front TFL Laminate. Note: because the without fronts option was chosen, a front and handle choice is not required.

FCLQD241865/NF/BBW

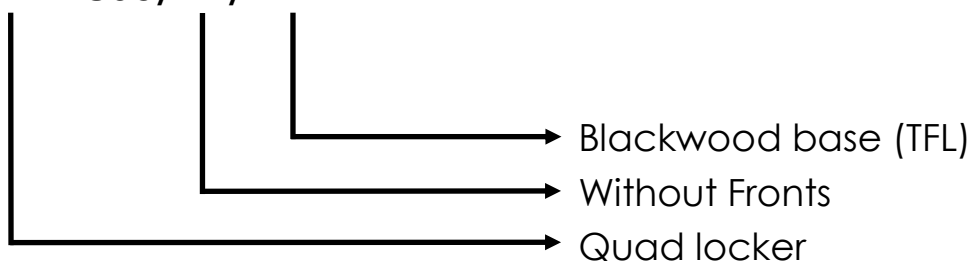

Common Top, TFL Laminate.

FCLWS6018/TAW

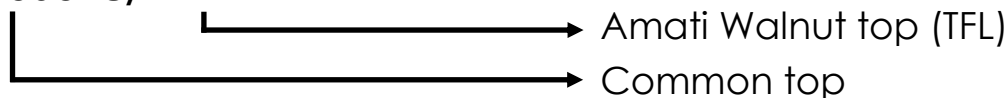

Lockers

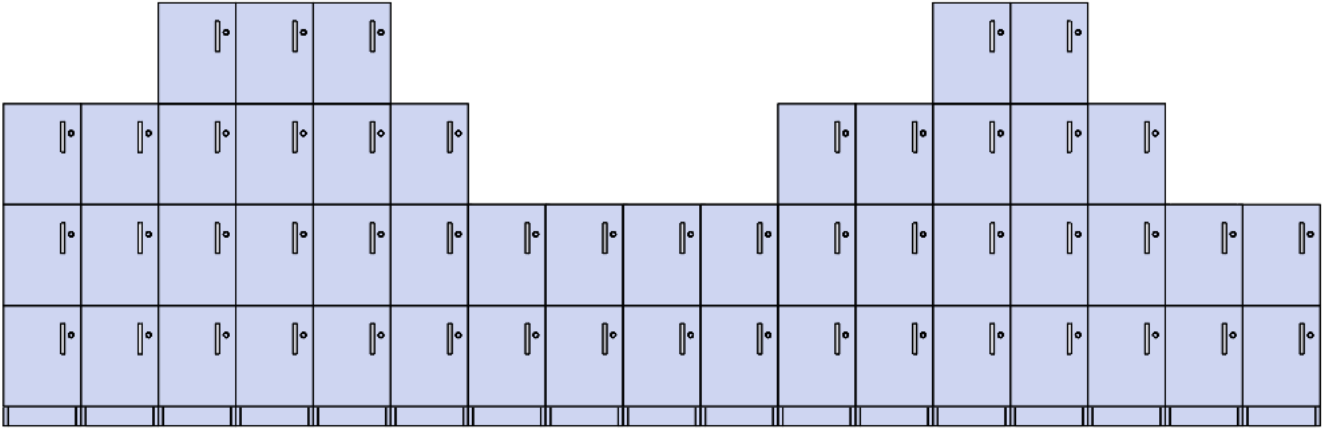
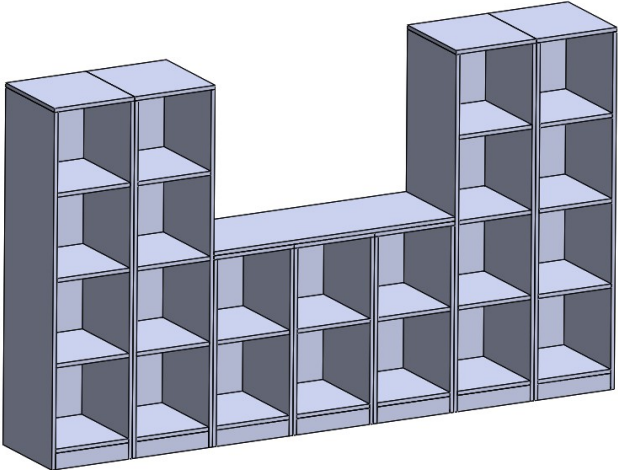
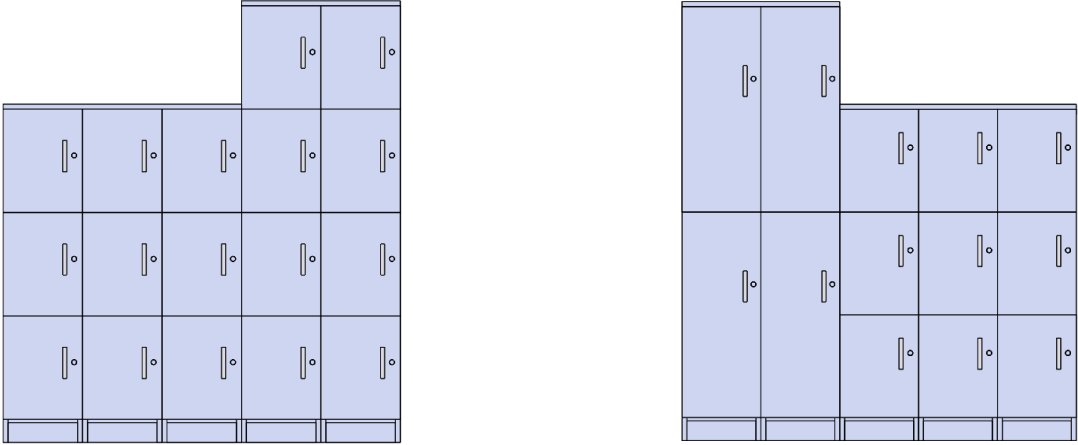

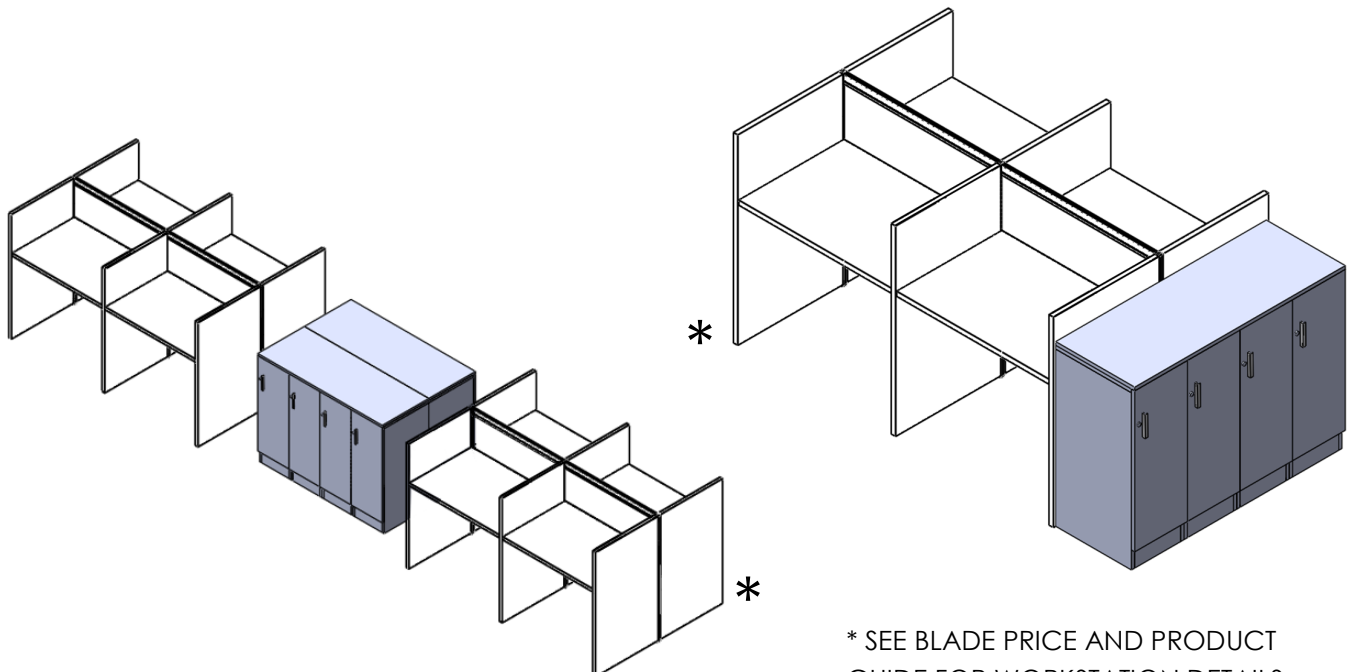
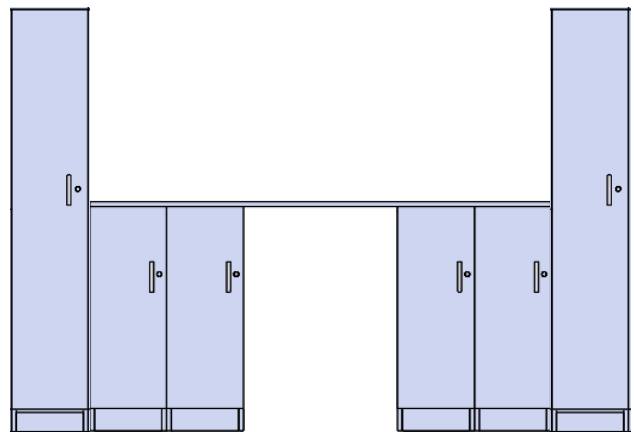
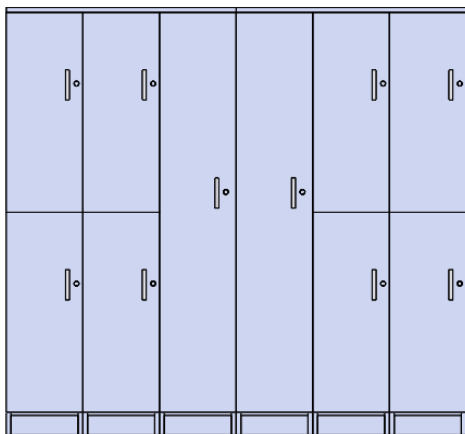
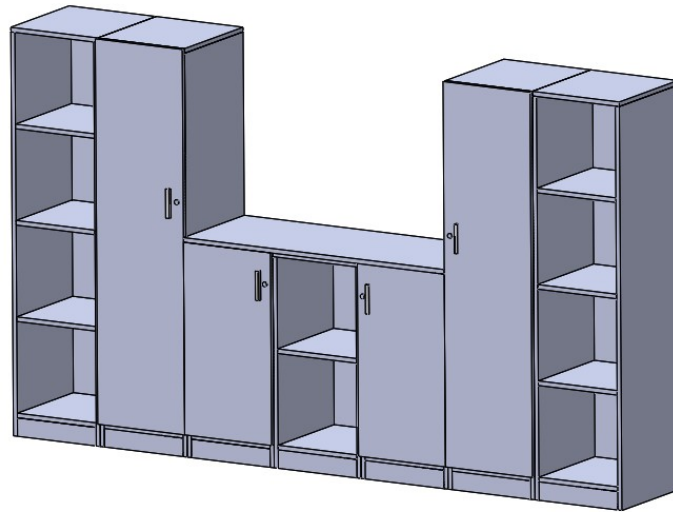

* SEE BLADE PRICE AND PRODUCT GUIDE FOR WORKSTATION DETAILS

FCLSD Single Locker

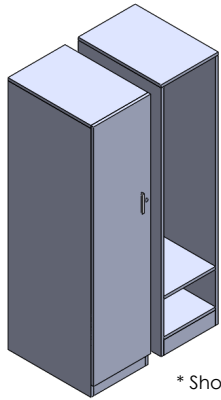

* Shown without front.

* Shown with front.
Left hand hinge location shown

What's Included:

One Single Locker (with or without door),
Handle and standard lock (with door option), **For electronic Lock add \$440 list Per Front**

Finish Options:

Please see www.fluidgroup.com/finishes for laminate options.

Information Required to Order: (see pages 8/9)

Follow this sequence of steps to develop the full code including available options.

- Locker Code - Select your choice of locker style and size
- Hinge Location - (L) Left, (R) Right, (NF) Without Fronts
- Base Finish - Grade 1 finishes, TFL
- Front Finish - Grade 1 finishes, TFL or Grade 2 finishes, HPL
- Handle Style - (BX1) Box Handle, (LP1) Medium Loop, (ELL) Electronic Lock (for Electronic Locks add \$440 List per Front)

Example Code: **FCLSD121850/L/BNW/CSW/BX1** (Left Hinge Location, Base Nova White, Front Silverwood, Box Handle)

Notes:

Grade 2 pricing refers to HPL front only.

Product Code	Product Description	# of Fronts	Interior Dimensions	List G1 (TFL) With Fronts	List G2 (HPL) With Fronts	List G1 (TFL) W/O Fronts
FCLSD121828	Single Locker, 12"W x 18"D x 28"H	1	10.5W x 16.5D x 22.5H			
FCLSD121835	Single Locker, 12"W x 18"D x 35"H	1	10.5W x 16.5D x 30.5H			
FCLSD121850	Single Locker, 12"W x 18"D x 50"H	1	10.5W x 16.5D x 45.5H			
FCLSD121865	Single Locker, 12"W x 18"D x 65"H	1	10.5W x 16.5D x 60.5H			
FCLSD122428	Single Locker, 12"W x 24"D x 28"H	1	10.5W x 22.5D x 22.5H			
FCLSD122435	Single Locker, 12"W x 24"D x 35"H	1	10.5W x 22.5D x 30.5H			
FCLSD122450	Single Locker, 12"W x 24"D x 50"H	1	10.5W x 22.5D x 45.5H			
FCLSD122465	Single Locker, 12"W x 24"D x 65"H	1	10.5W x 22.5D x 60.5H			
FCLSD161828	Single Locker, 16"W x 18"D x 28"H	1	14.5W x 16.5D x 22.5H			
FCLSD161835	Single Locker, 16"W x 18"D x 35"H	1	14.5W x 16.5D x 30.5H			
FCLSD161850	Single Locker, 16"W x 18"D x 50"H	1	14.5W x 16.5D x 45.5H			
FCLSD161865	Single Locker, 16"W x 18"D x 65"H	1	14.5W x 16.5D x 60.5H			
FCLSD162428	Single Locker, 16"W x 24"D x 28"H	1	14.5W x 22.5D x 22.5H			
FCLSD162435	Single Locker, 16"W x 24"D x 35"H	1	14.5W x 22.5D x 30.5H			
FCLSD162450	Single Locker, 16"W x 24"D x 50"H	1	14.5W x 22.5D x 45.5H			
FCLSD162465	Single Locker, 16"W x 24"D x 65"H	1	14.5W x 22.5D x 60.5H			

FCLDD

Double Locker

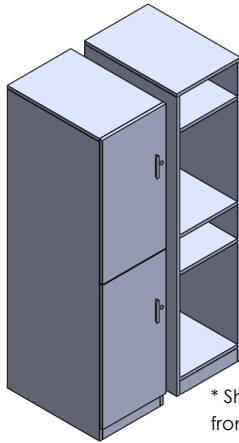

* Shown without fronts.

* Shown with fronts.
Left hand hinge location shown

What's Included:

One Double Locker (with or without door),
Handle and Standard Lock (with door option), **For Electronic Lock Add \$440 List Per Front**

Finish Options:

Please see www.fluidgroup.com/finishes for laminate options.

Information Required to Order: (see pages 8/9)

Follow this sequence of steps to develop the full code including available options.

- Locker Code - Select your choice of locker style and size
- Hinge Location - (L) Left, (R) Right, (NF) Without Fronts
- Base Finish - Grade 1 finishes, TFL
- Front Finish - Grade 1 finishes, TFL or Grade 2 finishes, HPL
- Handle Style - BX1) Box Handle, (LP1) Medium Loop,
(ELL) Electronic Lock (for Electronic Locks add \$440 List per Front)

Example: **FCLDD122465/L/BNW/CSW/B1** (Left Hinge Location, Base Nova White, Front Silverwood, Box Handle)

Note:

Grade 2 pricing refers to HPL fronts only.

Product Code	Product Description	# of Fronts	Interior Dimensions	List G1 (TFL) With Fronts	List G2 (HPL) With Fronts	List G1 (TFL) W/O Fronts
FCLDD121865	Double Locker, 12"W x 18"D x 65"H	2	10.5W x 16.5D x 30H			
FCLDD122465	Double Locker, 12"W x 24"D x 65"H	2	10.5W x 22.5D x 30H			
FCLDD161865	Double Locker, 16"W x 18"D x 65"H	2	14.5W x 16.5D x 30H			
FCLDD162465	Double Locker, 16"W x 24"D x 65"H	2	14.5W x 22.5D x 30H			

FCLQD

Quad Locker

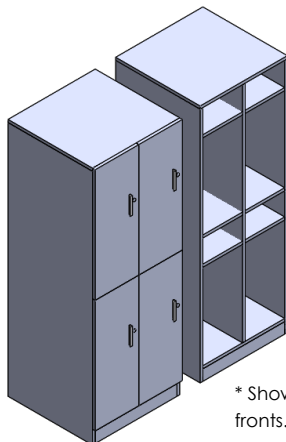

* Shown without fronts.

* Shown with fronts.
Left hand hinge

What's Included:

One Quad Locker (with or without door),
Handle and Standard Lock (with door option), **For Electronic Lock Add \$440 List Per Front**

Finish Options:

Please see www.fluidgroup.com/finishes for laminate options.

Information Required to Order: (see pages 8/9)

Follow this sequence of steps to develop the full code including available options.

- Locker Code - Select your choice of locker style and size
- Hinge Location - (L) Left, (R) Right, (NF) Without Fronts
- Base Finish - Grade 1 finishes, TFL1
- Front Finish - Grade 1 finishes, TFL1 or Grade 2 finishes, HPL1
- Handle Style - BX1) Box Handle, (LP1) Medium Loop,
(ELL) Electronic Lock (for Electronic Locks add \$440 List per Front)

Example: **FCLQD242465/L/BNW/CSW/B1** (Left Hinge Location, Base Nova White, Front Silverwood, Box Handle)

Note:

Grade 2 pricing refers to HPL fronts only.

Product Code	Product Description	# of Fronts	Interior Dimensions	List G1 (TFL) With Fronts	List G2 (HPL) With Fronts	List G1 (TFL) W/O Fronts
FCLQD241865	Quad Locker, 24"W x 18"D x 65"H	4	14.5W x 16.5D x 30H			
FCLQD242465	Quad Locker, 24"W x 24"D x 65"H	4	14.5W x 22.5D x 30H			

FCLCS

Single Width Cubby Locker

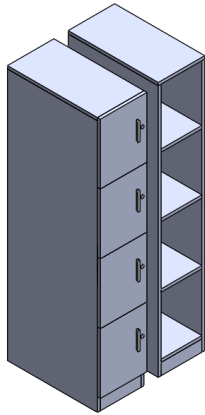

* Shown without fronts.

* Shown with fronts. Left hand hinge location shown

What's Included:

One Single Width Cubby Locker (with or without door), Handle and Standard Lock (with door option), **For Electronic Lock Add \$440 List Per Front**

Finish Options:

Please see www.fluidgroup.com/finishes for laminate options.

Information Required to Order: (see pages 8/9)

Follow this sequence of steps to develop the full code including available options.

- Locker Code - Select your choice of locker style and size
- Hinge Location - (L) Left, (R) Right, (NF) Without Fronts
- Base Finish - Grade 1 finishes, TFL
- Front Finish - Grade 1 finishes, TFL or Grade 2 finishes, HPL
- Handle Style - BX1) Box Handle, (LP1) Medium Loop, (ELL) Electronic Lock (for Electronic Locks add \$440 List per Front)

Example: **FCLCS121850/L/BNW/CSW/B1** (Left Hinge Location, Base Nova White, Front Silverwood, Box Handle)

Note:

Grade 2 pricing refers to HPL fronts only.

Product Code	Product Description	# of Fronts	Interior Dimensions	List G1 (TFL) With Fronts	List G2 (HPL) With Fronts	List G1 (TFL) W/O Fronts
FCLCS121835	Single Width Cubby 12"W x 18"D x 35"H	2	10.5W x 16.5D x 14.9H			
FCLCS121850	Single Width Cubby 12"W x 18"D x 50"H	3	10.5W x 16.5D x 14.6H			
FCLCS121865	Single Width Cubby 12"W x 18"D x 65"H	4	10.5W x 16.5D x 14.6H			
FCLCS161835	Single Width Cubby 16"W x 18"D x 35"H	2	14.5W x 16.5D x 14.9H			
FCLCS161850	Single Width Cubby 16"W x 18"D x 50"H	3	14.5W x 16.5D x 14.6H			
FCLCS161865	Single Width Cubby 16"W x 18"D x 65"H	4	14.5W x 16.5D x 14.6H			

FCLCD

Double Width Cubby Locker

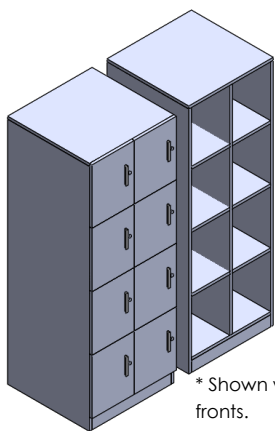

* Shown without fronts.

* Shown with fronts.
Left hand hinge location shown

What's Included:

One Double Width Cubby Locker (with or without door),
Handle and Standard Lock (with door option), **For Electronic Lock Add \$440 List Per Front**

Finish Options:

Please see www.fluidgroup.com/finishes for laminate options.

Information Required to Order: (see pages 8/9)

Follow this sequence of steps to develop the full code including available options.

- Locker Code - Select your choice of locker style and size
- Hinge Location - (L) Left, (R) Right, (NF) Without Fronts
- Base Finish - Grade 1 finishes, TFL
- Front Finish - Grade 1 finishes, TFL or Grade 2 finishes, HPL
- Handle Style - BX1) Box Handle, (LP1) Medium Loop,
(ELL) Electronic Lock (for Electronic Locks add \$440 List per Front)

Example: **FCLDD242450/L/BNW/CSW/B1** (Left Hinge Location, Base Nova White, Front Silverwood, Box Handle)

Note:

Grade 2 pricing refers to HPL fronts only.

Product Code	Product Description	# of Fronts	Interior Dimensions	List G1 (TFL) With Fronts	List G2 (HPL) With Fronts	List G1 (TFL) W/O Fronts
FCLCD241835	Double Width Cubby 24"W x 18"D x 35"H	4	10.5W x 16.5D x 14.9H			
FCLCD241850	Double Width Cubby 24"W x 18"D x 50"H	6	10.5W x 16.5D x 14.6H			
FCLCD241865	Double Width Cubby 24"W x 18"D x 65"H	8	10.5W x 16.5D x 14.6H			

FCLWS

Common Top

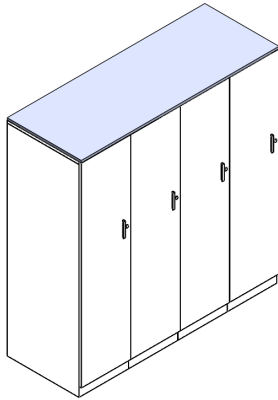
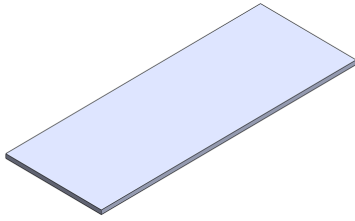

What's Included:

Common Top, All Necessary Hardware.

Finish Options:

Please see www.fluidgroup.com/finishes for laminate options.

Information Required to Order:

Common Top Code / Laminate Finish

Example: **FCLWS4824/THPNW** (High Pressure Nova White)

Product Code	Product Description	Number of Lockers			List (TFL) Grade 1	List (HPL) Grade 2
		12" Wide	16" Wide	24"		
FCLWS1218	Common Top, 12" W x 18" Deep	1				
FCLWS1618	Common Top, 16" W x 18" Deep		1			
FCLWS2418	Common Top, 24" W x 18" Deep	2		1		
FCLWS3218	Common Top, 32" W x 18" Deep		2			
FCLWS3618	Common Top, 36" W x 18" Deep	3				
FCLWS4818	Common Top, 48" W x 18" Deep	4	3	2		
FCLWS6018	Common Top, 60" W x 18" Deep	5				
FCLWS6418	Common Top, 64" W x 18" Deep		4			
FCLWS7218	Common Top, 72" W x 18" Deep	6		3		
FCLWS8018	Common Top, 80" W x 18" Deep		5			
FCLWS1224	Common Top, 12" W x 24" Deep	1				
FCLWS1624	Common Top, 16" W x 24" Deep		1			
FCLWS2424	Common Top, 24" W x 24" Deep	2		1		
FCLWS3224	Common Top, 32" W x 24" Deep		2			
FCLWS3624	Common Top, 36" W x 24" Deep	3				
FCLWS4824	Common Top, 48" W x 24" Deep	4	3	2		
FCLWS6024	Common Top, 60" W x 24" Deep	5				
FCLWS6424	Common Top, 64" W x 24" Deep		4			
FCLWS7224	Common Top, 72" W x 24" Deep	6		3		
FCLWS8024	Common Top, 80" W x 24" Deep		5			

FCLAS
Additional Shelf

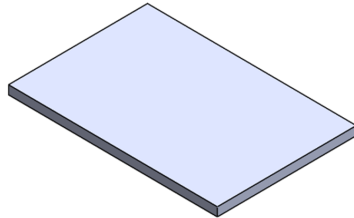

What's Included:
Additional Shelf.

Finish Options:
Please see www.fluidgroup.com/finishes for laminate options.

Information Required to Order:
Additional Shelf Code / Laminate Finish
Example: **FCLAS1218/BNW** (Base Nova White)

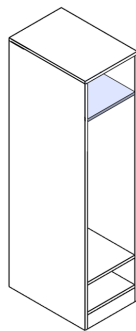

Product Code	Product Description	List (TFL) Grade 1
FCLAS1218	Additional Shelf, 12" W x 18" Deep	
FCLAS1224	Additional Shelf, 12" W x 24" Deep	
FCLAS1618	Additional Shelf, 16" W x 18" Deep	
FCLAS1624	Additional Shelf, 16" W x 24" Deep	

FCL

Accessories

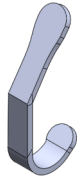

FCLHOOK

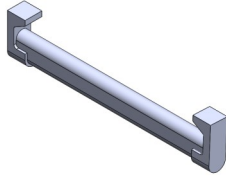

FCLROD

What's Included:

Accessory. All necessary Hardware

Finish Options:

Not Applicable

Information Required to Order:

Accessory Code

Product Code	Product Description	List
FCLHOOK	Coat Hook	
FCLROD12	12" Coat Rod	
FCLROD16	16" Coat Rod	
1 KEY2	Set of 2 keys	
1 LKEY2	Set of 2 Keys and Lock Cores	
1 CHKEY1	Change Key	
1 MKEY1	Master Key	
1 GANG1	Ganging hardware Set	

NUMPLT

Number Plate

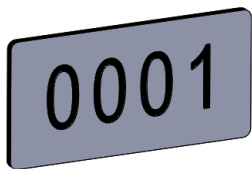

What's Included:

Self Adhesive Number Plate.

Finish Options:

Not Applicable

Information Required to Order:

Number Plate Code.

Notes:

If 10 plates are ordered, you will receive numbers 1 to 10. If another series is required, please contact the factory.

Product Code	Product Description	List
NUMPLT	1" x 2" Self Adhesive Number Plate	

Lockers

How to Order - Please send all purchase orders to order@fluidgroup.com or fax to 1.866.769.6057.

Questions - Call us toll free at 1.866.933.5258.

Please see www.fluidgroup.com for all information including:

- Terms & conditions
- Warranty information
- Local representation information
- Finishes & Resources

Thank-you for choosing fluidconcepts!

Fluidconcept & design inc.
96 Planchet Rd.
Concord Ontario Canada
L4K 2C7

TF. 1.866.933.5258
Fax. 1.866.789.6057
www.fluidgroup.com
order@fluidgroup.com

