







Owner Manual

American Beauty

Before starting your

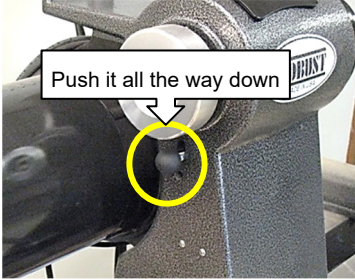

American Beauty:

<p>First: Be sure it is plugged into a working outlet of the proper voltage. This is a standard NEMA 6-20 outlet, rated for a maximum of 250 volts and 20 Amps. It is available at any hardware store.</p> <p>Note: GFI circuits are NOT compatible with your lathe.</p>	
<p>Be sure the Emergency Stop/main power switch is popped out. Just give it a little twist if it is pressed in and it should pop out.</p>	
<p>Be sure the spindle lock is all the way down – engaging the spindle lock disconnects the controls. Please note, the spindle lock might be only part way up – not enough to lock the spindle, but enough to disconnect the controls.</p>	
<p>For safety sake, put the speed dial at lowest setting.</p> <p>This is a great habit to get into every time you start your lathe.</p>	

Robust Tools, LLC 101 Business ID Barneveld, Wisconsin 53507

Please read the trouble shooting section. Phone: 608-924-1133 Email: info@turnrobust.com

ROBUST LATHES HAVE BEEN TESTED TO UL STD. 987 and CSA STD. C22.2 No. 105 AND ARE CE COMPLIANT

© Copyright 2020 by Robust Tools, LLC; All Rights Reserved. The information contained herein is subject to change. Robust Tools, LLC is not responsible for errors or omissions herein or for incidental damages in connection with the furnishing or use of this information.

20200707

WOODTURNING SAFETY

⚠ Failure to follow safety rules may result in serious personal injury.

1. **READ AND UNDERSTAND** the entire owner's manual before attempting assembly or operation.
2. **READ AND UNDERSTAND** the warnings posted on the machine and in this manual. Failure to comply with all of these warnings may cause serious injury. Replace the warning labels if they become obscured or removed.
3. **GET TRAINING:** This Lathe is designed and intended for use by properly trained and experienced personnel only. If you are not familiar with the proper and safe operation of a Lathe, do not use until proper training and knowledge have been obtained.
4. **DO NOT USE THIS LATHE FOR OTHER THAN ITS INTENDED USE.** If used for other purposes, Robust Tools LLC disclaims any real or implied warranty and holds itself harmless from any injury that may result from that use.
5. **KEEP GUARDS IN PLACE** and in working order.
6. **REMOVE ADJUSTING KEYS AND WRENCHES.** Form the habit of checking to see that keys and adjusting wrenches are removed from tool before turning it on.
7. **KEEP WORK AREA CLEAN.** Cluttered areas and benches invite accidents. Keep shop floor free of tripping hazards. Woodturning generates chips and sawdust. Clean up debris and keep your work area clean. Sawdust is a fire hazard.
8. **DON'T USE IN DANGEROUS ENVIRONMENT.** Don't use power tools in damp or wet locations, or expose them to rain. Keep work area well lighted.
9. **KEEP CHILDREN AWAY.** All visitors should be kept a safe distance from work area.
10. **MAKE WORKSHOP KID PROOF** with padlocks, master switches, or by removing starter keys.
11. **DON'T FORCE TOOL.** It will do the job better and safer at the rate for which it was designed.
12. **USE RIGHT TOOL.** Don't force tool or attachment to do a job for which it was not designed.
13. **USE PROPER EXTENSION CORD.** Make sure your extension cord is in good condition. When using an extension cord, be sure to use one heavy enough to carry the current your product will draw. An undersized cord will cause a drop in line voltage resulting in loss of power, overheating or malfunction. If in doubt, use the next heavier gage. The smaller the gage number, the heavier the cord. See table below:

Recommended wire size for extension cords based on length	25 feet	50 feet	100 feet
	14 AWG	14 AWG	12 AWG
NOTE: Cords longer than 100 feet are not recommended			

14. **WEAR PROPER APPAREL.** Do not wear loose clothing, gloves, neckties, rings, bracelets, or other jewelry which may get caught in moving parts. Nonslip footwear is recommended. Wear protective hair covering to contain long hair, including beards.
15. **ALWAYS USE SAFETY GLASSES AND FACE SHIELD.** Everyday eyeglasses only have impact resistant lenses, they are NOT safety glasses.
16. **SECURE WORK.** Use appropriate chucks, faceplates or other work holding devices to hold work when practical.
17. **DON'T OVERREACH.** Keep proper footing and balance at all times.
18. **MAINTAIN TOOLS WITH CARE.** Keep tools sharp and clean for best and safest performance. Follow instructions for lubricating and changing accessories.

19. **DISCONNECT TOOLS** before servicing; when changing accessories, such as blades, bits, cutters, and the like.
20. **REDUCE THE RISK OF UNINTENTIONAL STARTING.** Make sure switch is in off position before plugging in.
21. **USE RECOMMENDED ACCESSORIES.** Improper accessories may be hazardous. Consult the accessory owner's manual before use. The use of improper accessories may cause risk of injury to persons.
22. **NEVER STAND ON TOOL.** Serious injury could occur if the tool is tipped or if the cutting tool is unintentionally contacted.
23. **CHECK DAMAGED PARTS.** Before further use of the tool, a guard or other part that is damaged should be carefully checked to determine that it will operate properly and perform its intended function – check for alignment of moving parts, binding of moving parts, breakage of parts, mounting, and any other conditions that may affect its operation. A guard or other part that is damaged should be properly repaired or replaced.
24. **DO NOT MODIFY LATHE.** Do not modify lathe or use in a manner for which it was not designed.
25. **DUST WARNING.** The dust generated by some woods and wood products can cause health problems. Operate equipment in well ventilated areas and provide proper dust removal. Use a dust collection system whenever possible. Also use a dust mask or other personal protection.
26. **DISCONNECT FROM POWER.** Disconnect the equipment from power when assembling or maintaining.
27. **CHECK LATHE SET-UP WITH POWER OFF.** Examine the lathe set-up carefully and rotate the work piece by hand to check clearance before turning on power.
28. **NEVER LEAVE LATHE RUNNING UNATTENDED.** Do not leave lathe unless it is turned off and has come to a complete stop.
29. **MAKE ALL ADJUSTMENTS WITH POWER OFF.** Do not make adjustments when the lathe or work piece is turning. Make all adjustments with power off.
30. **TIGHTEN ALL CLAMPS BEFORE OPERATING LATHE.** All clamp handles on the banjo, toolrest, tailstock and auxiliary equipment should be tightened before operating lathe.
31. **CHECK THE WORKPIECE CAREFULLY** for splits, knots or other obstructions which may cause a safety risk while turning. Do not turn unsound wood.
32. **USE SLOW SPEED WHEN STARTING.** Always start out with slow speeds when turning a new or unbalanced work piece.
33. **ADJUST TOOLREST CLOSE TO THE WORK PIECE.** Before turning, rotate the work piece by hand to make sure it clears the toolrest. When turning, occasionally stop the lathe and readjust the toolrest to keep it close.
34. **KEEP TOOL ON TOOLREST.** Lathe tools should remain on the toolrest whenever the tool is in contact with the work piece.
35. **REMOVE TOOLREST WHEN SANDING OR FINISHING.** When sanding or finishing your work piece, remove the toolrest to prevent your fingers from getting pinched.
36. **FASTEN WORK PIECE SECURELY BETWEEN CENTERS.** When turning between centers, make sure the work piece is secure and that tailstock is locked before turning.
37. **USE CAUTION WHEN USING THE LATHE IN REVERSE.** When using reverse, be sure to secure the work holding device (chuck, faceplate, etc.) to the spindle with safety set screws. Reverse is generally only used when sanding.
38. **NEVER STOP A ROTATING WORKPIECE WITH YOUR HAND**
39. **IF GLUING UP A WORKPIECE:** always use a high-quality glue of the type necessary for that particular workpiece.

40. **FOLLOW LOCAL ELECTRICAL CODES.** Make sure wiring codes and recommended electrical connections are followed and that the machine is properly grounded
41. **GROUNDING INSTRUCTIONS:** In the event of a malfunction or breakdown, grounding provides a path of least resistance for electric current to reduce the risk of electric shock. You lathe is equipped with an electric cord having an equipment grounding conductor and a grounding plug. The plug must be plugged into a matching outlet that is properly installed and grounded in accordance with all local codes and ordinances.

Do not modify the plug provided – if it will not fit the outlet, have the proper outlet installed by a qualified electrician. Improper connection of the equipment-grounding conductor can result in a risk of electric shock. The conductor with insulation having an outer surface that is green with or without yellow stripes is the equipment-grounding conductor. If repair or replacement of the electric cord or plug is necessary, do not connect the equipment-grounding conductor to a live terminal. Check with a qualified electrician or service personnel if the grounding instructions are not completely understood, or if in doubt as to whether the tool is properly grounded. Use only 3-wire extension cords that have 3-prong grounding plugs and 3-pole receptacles that accept the tool’s plug. Repair or replace damaged or worn cord immediately.

Lathes wired to run on 110-120 volt circuits are intended for use on a circuit that has an outlet (NEMA 5-15) that looks like the one illustrated in Sketch A in the figure below. The tool has a grounding plug that looks like the plug also illustrated in the figure. A temporary adapter, which looks like the adapter illustrated in Sketches B and C, may be used to connect this plug to a 2-pole receptacle as shown in Sketch B if a properly grounded outlet is not available. The temporary adapter should be used only until a properly grounded outlet can be installed by a qualified electrician. The green-colored rigid ear, lug, and the like, extending from the adapter must be connected to a permanent ground such as a properly grounded outlet box.

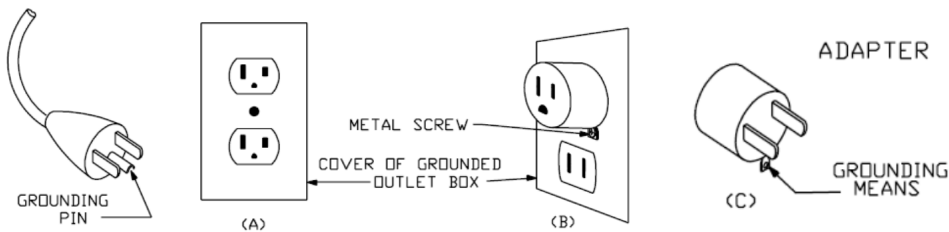

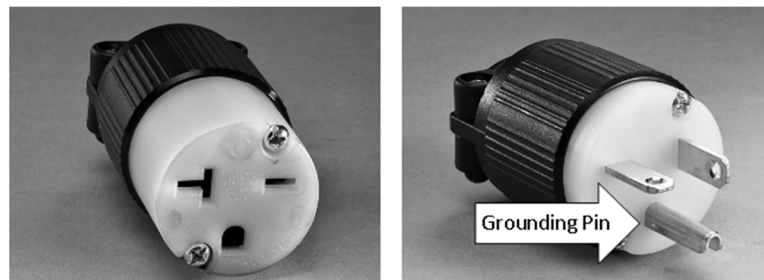

Lathes wired for operation on a 220-240 volt circuit are intended for use on a circuit that has an grounded outlet and plug that looks like those illustrated below (NEMA 6-20).



***** SAVE THESE INSTRUCTIONS *****

Installation

Consideration	Recommendation
Unpacking	Your lathe is shipped fully assembled. Robust lathes are heavy. Get help. Use care when removing the lathe from the pallet. Use a 2x4 under the ways to lift one end of the lathe at a time off the pallet. See "Delivery and Unpacking" in the "Info" section of our website.
Lathe Location	The best location is on a level concrete floor close to a power source in an area with good lighting. Provide clearance on all sides of the lathe. Other machines in your shop should not interfere with the operation of the lathe.
Lighting	Your shop and the work area around the lathe should have adequate lighting. A movable spotlight may be helpful. A light stand-off mount is included on top of the headstock for easy light mounting.
Bolting to Floor	If you do not plan to move your lathe, you might consider bolting it to the floor. First make sure it is level and settled per other instructions in this manual and then use any good quality anchor. If you are bolting to concrete, make sure there are no expansion joints or cracks between the legs. If bolting to a wooden floor, it is best to get over the joists. Settle the lathe both before and after bolting.
Ventilation	Your shop should be adequately ventilated. The amount of ventilation needed varies based on the size of the shop and the amount of work done. The use of dust collectors and filters will minimize risks to your health. Some woods are toxic or will cause allergic reactions.
Electrical	<p>The American Beauty is wired for 220V. An isolated 220VAC, 20 amp circuit is required. Wiring and outlets should adhere to local electrical codes. Avoid using extension cords.</p> <p> If you are in doubt about the power connection, seek advice from a qualified electrician.</p>
	<p>Required 220 Volt NEMA 6-20 Receptacle</p> 
Lathe Height	Most turners like to adjust the height of the lathe legs so the centerline of the lathe spindle is at the elbow height of the turner. Adjust up or down from there to where it is comfortable for you. See instructions for this elsewhere in the manual.

Routine Maintenance

Interval	Maintenance
After each use	<p>Clean the work area and lathe. Clear dust from the inside the headstock, between the lathe bed rails, and under the banjo and tailstock. Clean up any finish or glue from ways.</p> <p> Some solvents and glues will affect the painted surfaces. Cover up the paint if you don't want it affected by solvent and glues.</p>
Monthly	Remove the banjo and clean and lightly lubricate the cam shaft and cam shaft follower. Lubricate the bed ways with paste wax. Clean and lubricate with one or two drops of light-weight oil the outside of the quill and the tailstock cam shaft. Loosen the belt and clean its contact side and the grooves in the pulleys with an old tooth brush. Recheck belt tension. Remove tool rest clamp from banjo and clean and lubricate bushings and holes.
6 Months	Clean and grease tailstock quill threads-- screw the quill all the way out, grease the nut in the quill and crank the quill back in; wipe off excess. Any general purpose grease is fine.
Yearly	Vacuum out the box under the bed that the inverter lives in.
Never	The spindle and motor bearings are permanently lubricated and need no maintenance.

Electric Motor

Your lathe is equipped with a 3 phase AC industrial grade motor. The motor is fan cooled. If the lathe has run for a long time on slow speed the motor may stop as the fan is not turning fast enough to cool the motor sufficiently. Allow the motor to cool before continuing.

Inverter

Your lathe is equipped with an industrial grade variable frequency drive, also known as an “inverter”. The inverter takes normal household current and converts it to industrial 3 phase power. When you change the spindle speed dial on the pendant controller, the inverter changes the frequency sent to the motor which changes the motor speed.

The inverter is factory set with parameters that most turners will like. The inverter manual shows how to change the settings. Changing certain settings will prevent your lathe from running properly, if at all. Other settings, such as ramp up and ramp down speeds can be set to your liking. Your inverter may be equipped with a fan that runs for a moment or two after the motor stops.

Inverter in leg assembly of American Beauty. Appearance may vary.



⚠ It is strongly recommended not to change any inverter parameters until you are very familiar with your lathe and are familiar with inverters.

Pendant Controller

The corded pendant controller is used to control major functions of your lathe. It has strong rare earth magnets on the back so it can be moved and attached to sections of your lathe as needed.

Control	Function
Spindle Speed	<p>Twist the knob to the left to go slow and to the right to go fast. Approximate speeds are indicated. Be sure to know the belt position to make the most of this information.</p> <p>⚠ It is a good idea to set the speed at its slowest setting and gradually increase to the desired speed every time you start the lathe.</p>
Forward/Reverse	<p>Twist the switch to the right to go forward Twist the switch to the left to go in reverse</p> <p>⚠ You can change direction with the lathe is running. The lathe will slow down, stop, and then reverse direction. This will not harm the inverter or motor.</p> <p>⚠ Use caution when turning in reverse. Your work holding device (chuck, faceplate, etc.) should be secured to the spindle if reverse is used.</p>
Spindle Stop	Press to stop spindle rotation.

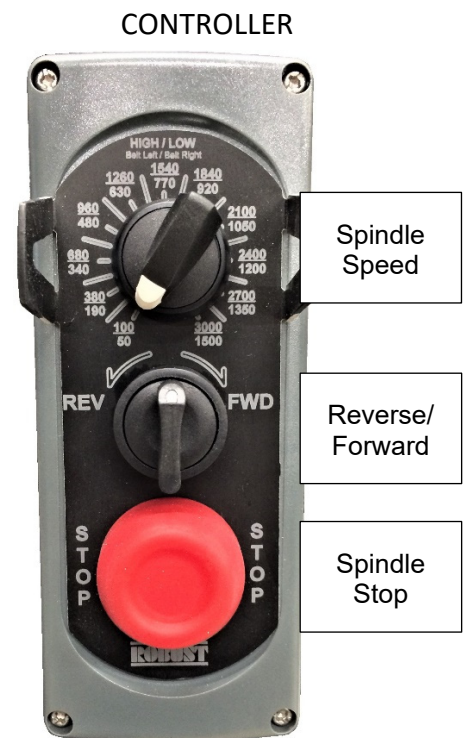

Spindle Lock Knob

The Spindle Lock Knob is located under the handwheel. Slide it up to engage the spindle lock. Slide it down to disengage.

⚠ The lathe cannot be operated when the Spindle Lock Knob is in the up position. This serves as a safety interlock. Please note that the Spindle Lock Knob must be all the way down for the lathe to start and run in a normal fashion. Sometimes the knob will jiggle up just enough to open the internal switch and the lathe will not run until the knob is pushed all the way down.

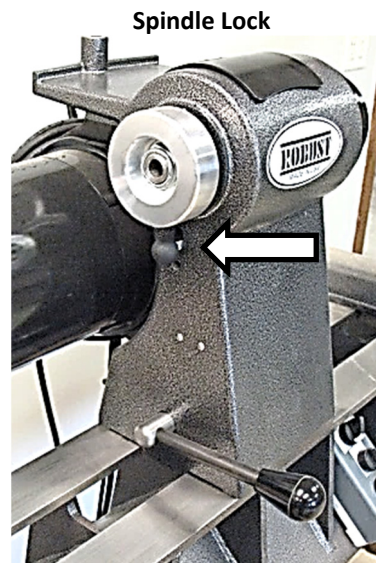

Mounting a Faceplate or Chuck

1. Turn off the lathe.
2. Engage the spindle lock to secure the spindle.
3. Screw the faceplate or chuck onto the spindle threads. It is OK to use a spindle washer.

⚠ For safe and vibration free operation, the faceplate or chuck body must contact the shoulder on the spindle.

4. Release the Spindle Lock before starting the lathe.

⚠ Some faceplates and chucks are equipped with a set screw. Before tightening this set screw, ensure it lines up with the spindle groove. Be sure to fully loosen the set screw before faceplate or chuck removal.

Lathe Spindle



Spindle Index

The spindle index holes are located in the handwheel and numbered 1-48. The index screw can be used to divide the work into 2, 3, 4, 6, 8, 12, 16, 24, or 48 divisions.

1. **⚠** Turn off the lathe. The Master Switch/E-Stop should be in the Off position.
2. Open the top headstock cover to gain access to the Spindle Index Screw.
3. Turn the spindle handwheel to align the screw to the desired hole and finger-tighten the Spindle Index Screw.

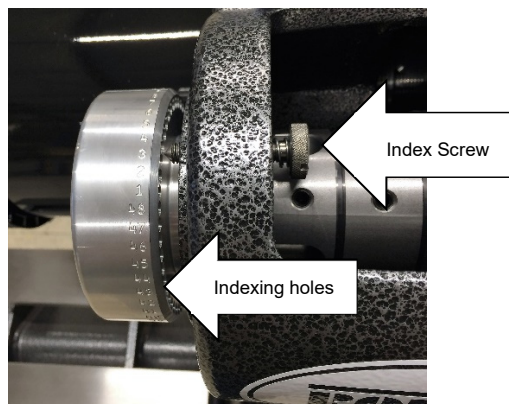

⚠ Make sure the spindle index screw is disengaged before operating the lathe.

Banjo and Toolrest Operation

BANJO: To move the banjo lift the Banjo Lever to a vertical position, slide the banjo to the desired position, then push the lever left or right to lock the banjo in place. When locked, the Banjo Release Lever should go just past horizontal as shown in the picture. Keep the bottom of banjo and banjo shaft clean and only lightly oiled or waxed. This minimizes dust build up and dragging.

TOOLREST: To adjust the toolrest, loosen the Toolrest Clamp Handle, position the toolrest, and tighten the clamp handle. The toolrest clamp position is easily adjusted. First clamp a toolrest into the banjo, then simply pull out on the handle, turn it to the desired spot and push it back in.

To move the tool rest clamp to the other side of the banjo, first loosen it and remove the tool rest. Then pull the tool rest assembly straight out and insert from the other side. Make sure the bevels on the tool rest clamp bushings are located to accept the tool rest post.

- ⚠ Keep the toolrest close to the work. Stop the lathe to adjust the toolrest. Spin the work by hand before starting to make sure all parts of the work piece clear the toolrest.
- ⚠ Gouges and chisels should remain on the toolrest whenever the tool is in contact with the work piece.
- ⚠ Remove the toolrest when sanding or polishing so fingers do not get pinched.

Using the Banjo and Toolrest

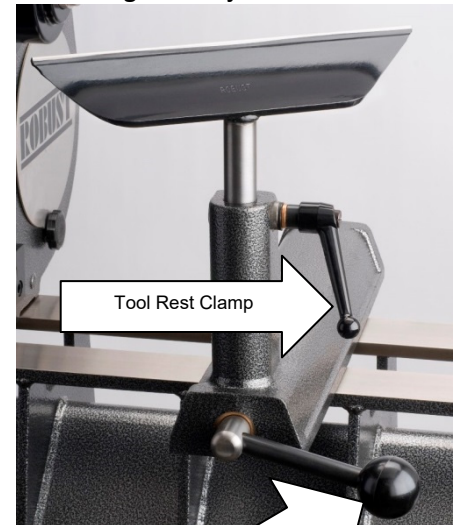

Tailstock Operation

To move the tailstock, lift the locking lever and slide it to the desired spot. Then push the lever down to lock the tailstock in place.

To move the tailstock quill in or out, loosen the Quill Lock and turn the Quill Handwheel. Lock the quill by tightening the quill lock.

HINT: adjust the lock handle so that it is level when locked, it only takes a ¼ turn to unlock it (see note above about adjusting handles).

The tailstock quill accepts accessories with #2 Morse taper (#3 MT is optional on the American Beauty).

To install an accessory with a Morse taper, first clean the male and female parts. Use a quick, firm action by hand. Do not pound.

To remove the accessory, turn the Quill Handwheel to screw the quill back into the tailstock, and the accessory should self-eject. Please note, if your accessory is short, self-ejection may not work. In that case use the knock our rod.

- ⚠ Never loosen the tailstock while the work piece is turning.

Using the Tailstock

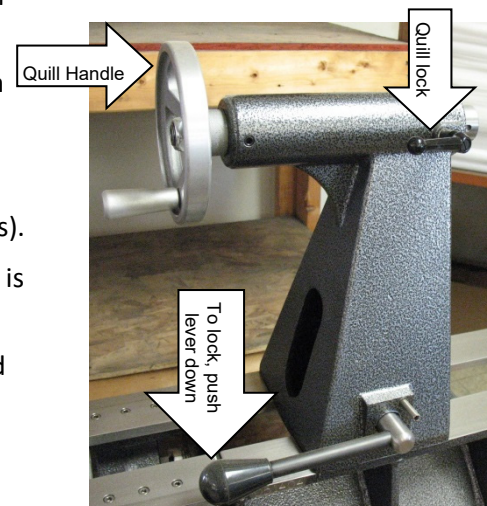

Spindle Removal and/or Belt Replacement

Your lathe is equipped with a high quality ten groove Poly-V belt that is designed to provide years of service. If you should ever find a need to replace it, follow these instructions.

1. ⚠️ Stop the lathe, **disconnect from power** and open top and front headstock covers.
2. Loosen the Motor Clamp and raise the motor to loosen the belt. Tighten the clamp once the belt is loose.
3. Lock the spindle using the spindle lock and remove the nut securing the handwheel to the spindle using a 1-7/16" socket wrench. Then remove the handwheel.
4. Remove the spindle index screw.
5. Using a 3/16 inch Allen wrench, remove the cap screws on the front spindle bearing boss.
6. Screw two of the cap screws into the threaded jack screw holes in the boss to push the spindle assembly out as a unit. You may need to clean debris from the holes first.
7. Remove the old belt and replace with new belt.
8. Remove the jack screws from the bearing boss.
9. Clean all mating parts before reassembly and clean the grooves in the pulleys.
10. Insert the spindle assembly back into the headstock and replace and tighten the cap screws.
11. Reinstall the spindle lock mechanism if you removed it
12. Reinstall the index screw and bracket
13. Reinstall the spindle handwheel and nut. **The nut should be tightened until it just seats, and no more.**
14. Move the belt to the desired step on the pulleys and tighten the belt.
15. Close the top and front headstock covers.

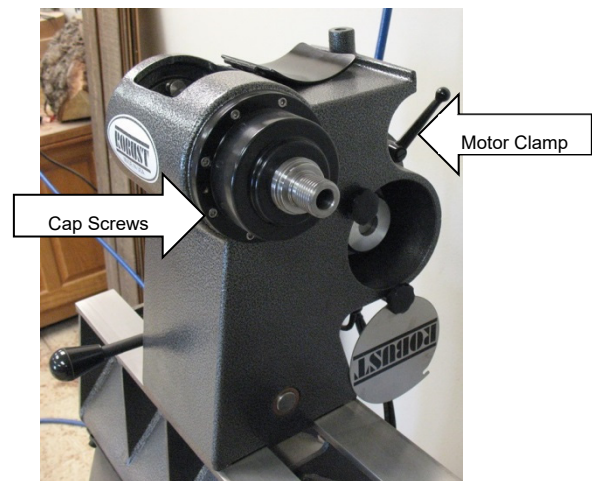
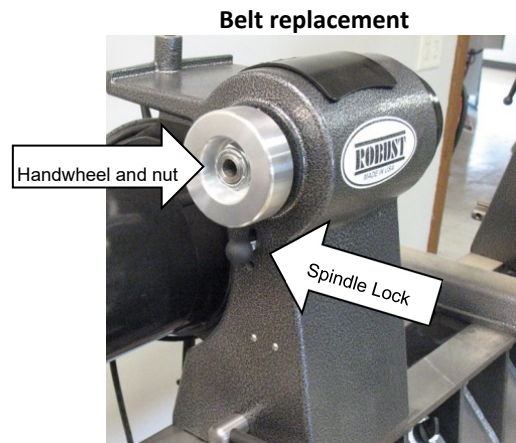

Optional Vacuum Adapter

The vacuum adapter simply slips into the spindle on the handwheel end.

Some lubricant on the O-rings makes this process easier and extends the life of the O-rings. If you do wear out the O-rings, they are a common size and found at many places.



Optional Casters Set

Castors provide mobility for your lathe, making it easier to move it around the shop. Keep in mind the following points about castors:

- ⚠ Castors are for moving the machine on level surfaces and should be removed when turning.
 - ⚠ Castors fit loose until there is weight on them.
 - ⚠ Use great caution on inclines. Your lathe is heavy and it may roll away unexpectedly.
 - ⚠ Remove castors before turning.
1. Using the provided jack, lift one end of the lathe to take the weight off the legs. There is a bracket on the jack that fits into notches on the leg aprons.
 2. Pull up on the spring loaded pin on the caster bracket.
 3. Place the tab on the caster bracket into the hole in the leg, with the pin over the hole in the foot.
 4. Release the spring loaded pin so that it drops through the hole in the foot.
 - ⚠ Make sure the pin is all the way through the foot, otherwise it may be bent by the weight of the lathe.
 5. Install one caster on each leg base.
 6. Lower the lathe and repeat the process on the other end.
 7. Removal is the reverse.

American Beauty screw jack

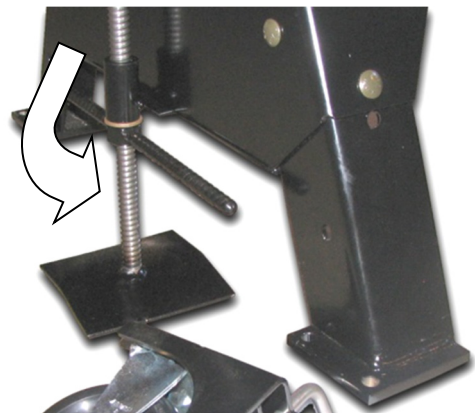

Dropping the Pin Through the Leg Base Hole

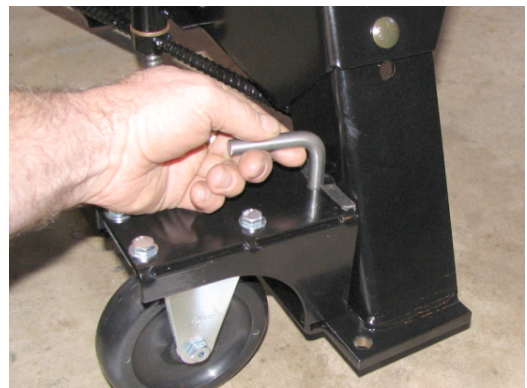

TURNING SPEEDS

American Beauty Recommended Woodturning Speeds		
Maximum Diameter in inches	Recommended starting speed for sound and balanced work	Recommended maximum speed for sound and balanced work
24	250	375
22	273	409
20	300	450
18	333	500
16	375	563
14	429	643
12	500	750
10	600	900
8	750	1125
6	1000	1500
4	1500	2250
2	3000	3000
Unshaded cells = low speed pulley		
Shaded cells = high speed pulley		
<p>Important Notes: Speeds in this chart are conservative guidelines for sound and balanced work. If your work is unbalanced or contains defects of any kind, much lower speeds should be used. If the wood has structural flaws do not turn it.</p>		

Changing the spindle height: The American Beauty has four independently adjustable legs. Position the lathe where you are going to use it before adjusting.

First, support one end with a jack. If you have the caster kit, use that jack. Some car jacks will fit in the same notch. If you use a scissor jack or hydraulic jack, use a board for extra support across the notch.

When supported, loosen the individual clamp bolts (see arrow on picture) so that the legs will slide up and down. Raise or lower the jack to the desired height. When you have it where you want it, be sure the legs are touching the floor, then tighten the leg clamp bolts. Repeat on the other end.

NOTE: There are stop screws to keep the legs from moving too far and letting the machine drop when the clamp bolts are loose. You may need to reposition these screws when you adjust the legs.

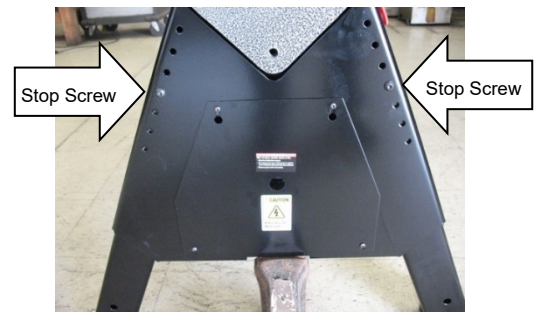
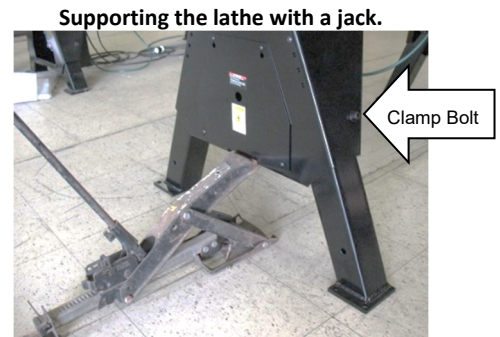

“Settling” the lathe: To prevent vibration, it is important that the lathe’s weight is supported evenly on all four legs and that the hard rubber foot pads are installed. After adjusting the height or moving the lathe, you may find that the lathe is not setting evenly in its new location. Determine which leg is short. Support that end of the lathe with a jack, and then loosen its clamp. Slide the leg to the floor and retighten the clamp bolt.

After all legs are touching the floor, go around the lathe and loosen the eight bolts that hold the leg aprons to the lathe bed. Loosen the bolts just enough to get the washers loose. Then rock the lathe as shown in the bottom picture and let the legs settle to your floor conditions.

You should have some movement when you do this. If not, you have probably exceeded the movement range of the slots the leg bolts ride in. In that case, you will need to lengthen or shorten one or more legs to get the slots in a range that will allow settling (see how to adjust legs above).

When you have movement, find a spot about midway the extremes and tighten up the bolts a little at a time – 2-3 passes. Your lathe should now be setting with its weight evenly distributed.

Having the lathe settled on the floor is more important than having the lathe perfectly level. Be sure to also install the foot pads.

“Settling” the lathe – loosen all bolts like the two pictured below, just until the washers are loose.

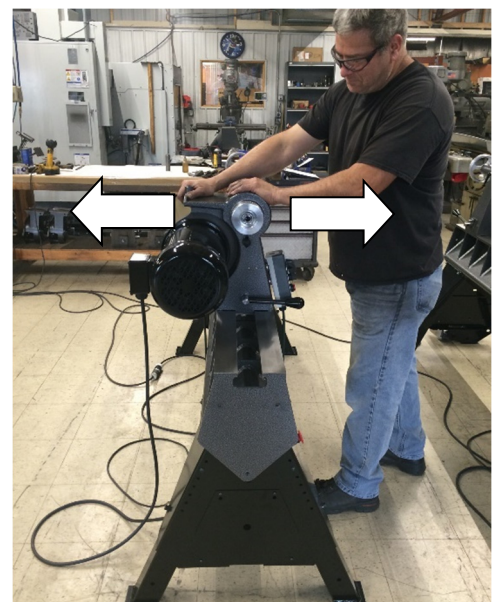
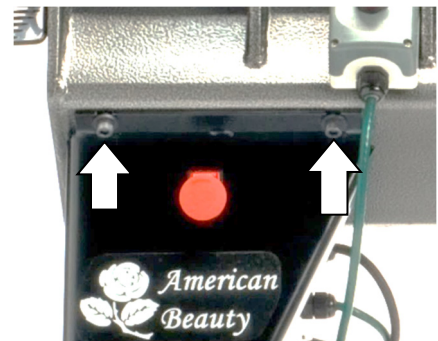

With the bolts loose, you should be able to rock the lathe while the lathe’s feet stay on the floor.

Adjusting Headstock Position

Stand at the end of the lathe and lift the locking lever. To slide the headstock towards the tailstock, push on the motor with one hand and on the base of the headstock with the other. To slide it back, pull on the motor with one hand and reach forward and grab the front of the headstock near the base with the other.

The lever should go just past horizontal when locked, but not touch the lathe bed.

Note: It is easy to bump the spindle lock doing this. Make sure the spindle lock is fully disengaged before starting the lathe.

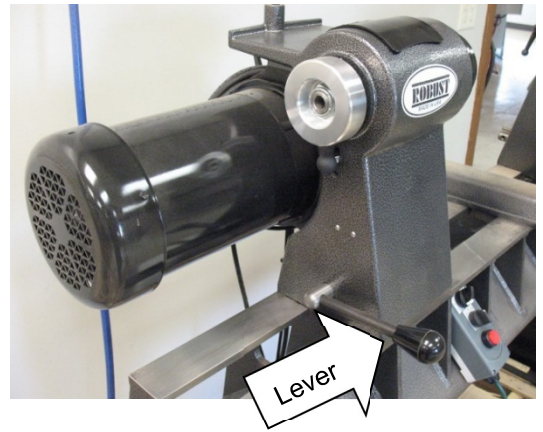

⚠ Do not position the headstock all the way onto the Tilt Away. For best performance, the headstock should be half on the lathe bed and half on the Tilt Away

HEADSTOCK ALIGNMENT WITH TAILSTOCK: For optimum alignment push both headstock and tailstock against back way (directly away from you). If you are having problem with alignment, also look for accumulated debris under the headstock and tailstock.

A bed stop is installed on the headstock end of the bed.

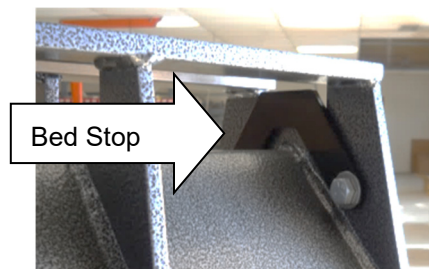

Main Power / Emergency Stop

This switch serves as the master on/off switch and emergency stop switch for the lathe.

Twist and release to turn the power On.

Push to turn the lathe Off.

PLEASE NOTE: If you rapidly cycle this switch, the inverter may go into a fault mode. You will need to unplug the machine for several minutes for the inverter to reset.

⚠ Do not leave the lathe unattended with power on. It is recommended that you turn off the main power when you are away from the lathe. For maximum protection, unplug the lathe when not in use.

Master On/Off – Emergency Stop



Changing Belt Position

1. ⚠️ Turn off the lathe. The Master Switch/E-Stop should be in the Off position.
2. Open front and top headstock covers.
3. Loosen the Motor Lock and lift the motor to loosen the belt, then lock the motor in the raised position with the motor lock.
4. Move the belt to the desired step on the spindle headstock pulley and then to the corresponding step on the motor pulley. Ensure that the belt is seated in the grooves on both pulleys.
5. Loosen the motor lock and lower the motor with the motor lever. While applying slight downward pressure on the motor, tighten the motor lock.
6. Close the top and side headstock covers.

⚠️ Don't apply excess tension to the belt. Excess belt tension can cause increased bearing wear, belt wear, and damage to the motor shaft.

Belt Position	RPM Range	Guideline
Right	50 - 1500	For high torque, low speed applications, like rough turning a large bowl.
Left	100 - 3000	For general purpose turning and high speed work like spindles and small bowls.

Changing Belt Positions on the AB between high speed and low speed/high torque



High speed is on the left, low speed/high torque is on the right (where belt is now)

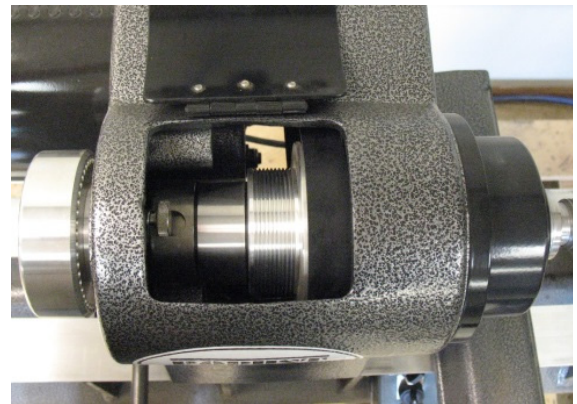



LIVE CENTER: A precision 40 degree angular contact ball bearing, sealed & lubricated for life, carries both the thrust load and rear radial load. It may feel loose when not under load. This is normal.

DRIVE CENTER: The cup style drive center is perfect for safely driving spindles and small bowls. If you get a catch, the wood just spins on the center. Like our Live Center, the tip is adjustable and reversible. The Bowl Drive threads onto the cup center and provides more surface area for driving larger work.

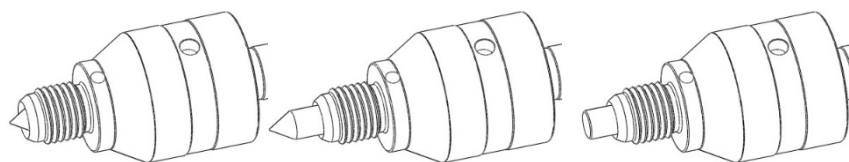
The moveable tip of the live or drive centers extend and reverse to accommodate your turning. The bodies are threaded 3/4-10 for standard accessories. A 5/16" thru hole accommodates drilling.

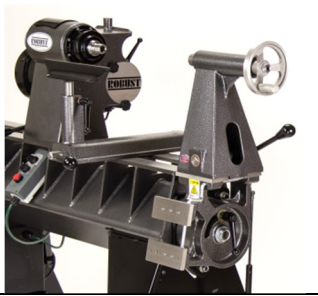

Optional American Beauty Tilt-Away™

		
<p>1. Slide tailstock onto Tilt Away. Lock the tailstock in place.</p>	<p>2. Loosen the Tilt Away lock-down and carefully tilt the tailstock out of your way. Do not let it slam.</p>	<p>3. When tailstock is tilted, re-tighten the lock-down. Reverse the procedure to put the tailstock back.</p>

⚠ Do not let the tailstock drop or fall uncontrolled; damage or misalignment may occur.

⚠ Do not position the headstock all the way onto the Tilt Away. At the most extreme position, the headstock should be half on the lathe bed and half on the Tilt Away.

Optional Gas Shock Assist

You will need to give your tailstock a nudge to get it to tip over.

Be careful when putting the tailstock back into position so that the gas shock does not slam the tailstock upright. If you let the tailstock slam in either direction, you may need to realign the Tilt-Away. See below.

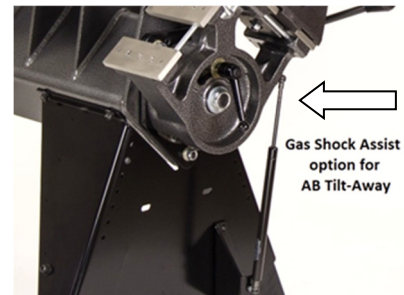

Minor Misalignment of Tilt-Away

The main reason the Tilt-Away gets out alignment is that the tailstock was allowed to slam in one direction or the other.

Final position of the Tilt-Away is determined by the stop screws found just behind and underneath the rotating component. Often times a simple adjustment of one of these set screws will get your Tilt-Away working as good as new.



A stop block with set screws and lock nuts determines the position of the Tilt-Away.

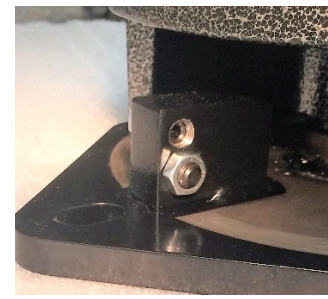

Use a 3/16" Allen wrench and 9/16" combination wrench to adjust stops.

Complete Field Re-alignment of the American Beauty Tilt Away Do this only if the procedure above has failed, or if you have removed your Tilt-Away for any reason.

1. Remove the tailstock and banjo. If you have the optional gas shock, remove that too.
2. Pivot the Tilt-Away so that the set of ways the tailstock normally slides on to is facing up as far as it can go (hard against the stop) and tighten the clamp.
3. Loosen the three nuts holding the Tilt Away and slide the headstock half way on. "Wiggle" the Tilt-Away into position. Put your knee under it for support. Tighten the headstock to the ways.
4. Gently snug down the three nuts. Slide the headstock on and off to check alignment. Repeats as needed. In extreme cases, adjust the two set screws in the plate above the top two nuts.
5. When operation is satisfactory, firmly tighten the three nuts.

TROUBLE SHOOTING

Failure to Start, try these six steps in order:

1) Push down on the spindle lock: it may have moved upward just enough to open the internal safety switch but not enough to lock the spindle. If the problem happens frequently, try tightening up the adjustment screw that puts tension on the spindle lock. You'll find it in the threaded hole directly below the spindle lock knob.

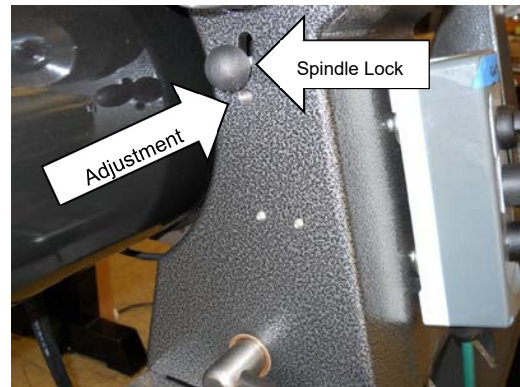

2) Check the emergency off switch. If you've bumped it, you'll need to give it a little twist to re-establish power.

3) Check that the lathe is plugged in to a working outlet of the correct voltage.

4) Check that the circuit breaker has not tripped.

5) Look for dust or debris that might interfere with movement of the switches on the pendant controller. Disconnect the power, open the controller and clean the switches with compressed air. Check that all wire connections are tight.

6) Remove the cover plate over the inverter and check the inverter for error codes. A blank screen means there is no power to the inverter, so check out 2-4 above. If there is power, the display should read "0.0."

ANYTHING ELSE WILL BE AN ERROR CODE. If the error code is "POFF" you do not have correct power to the unit. You'll typically only see this the first time you start the lathe from new. This error code indicates there is only 110v going to the machine, not 220. Time to call an electrician.

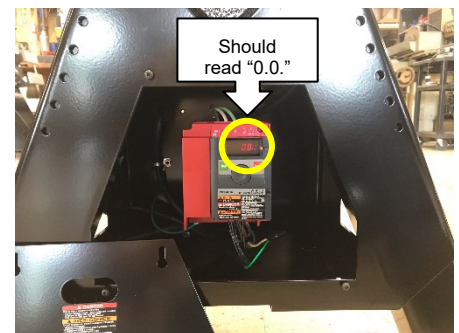

If any other error code is present, clear it by unplugging the machine until the display goes completely blank (**a quick power down will not be sufficient – the lathe must be unplugged for 2-3 minutes**). After the code has cleared, plug the lathe back in and let it reboot. If you are consistently getting error codes, call Robust with the error code. **If it still will not run, DO NOT attempt to program the drive.**

INTERMITTENT STOPPING: If your lathe shuts down for no apparent reason while you are making cuts or turning out of balance work, but you can start it right back up, see #1 above.

LOSS OF POWER-Lathe bogging down: Make sure you are using the large pulley on the spindle for heavy cuts and coring. Coring takes a lot of horsepower. The cutter blade rubbing or loading up with shavings acts like a disc brake. Go slow and sharpen often. If the belt is slipping, thumb pressure on the motor or motor mount is normally more than enough to ensure power transmission. Also look for dirt or oil on the belt by loosening it, turning it inside out and cleaning it and the pulleys using a fine brush. **Do not apply belt dressing as belt dressing just collects dust.** Remember: horsepower is not a substitute for sharp tools and good technique. Overloading the machine will result in an error code of "OP3" on your inverter. Reset is described above. Remember: horsepower is not a substitute for sharp tools and good technique.

SPINDLE LOCK IS HARD TO MOVE: Squirt a little light oil into the slot and work it up and down. You can also loosen the screw that puts tension on the spindle lock, see #1 above. Too much tension and you won't be able to move the spindle lock, too little and you may get some intermittent stopping (see above).

PROBLEM WITH CENTER ALIGNMENT: For optimum alignment push the headstock and tailstock away from you, against the back way. Also look for debris stuck to the bottom of the headstock or tailstock. A very small amount can make a big difference. If cleaning does not re-establish alignment, settle the lathe as described elsewhere. If you have bolted your lathe down, it is especially important to settle the lathe afterwards. Clean your Morse Tapers and check for burrs.

TAILSTOCK DOES NOT SLIDE NICELY ONTO TILT-AWAY: See the Tilt-Away page for instructions on realignment. Start with the “Minor Misalignment” section.

BANJO, TAILSTOCK OR HEADSTOCK WILL NOT SLIDE EASILY: Clean the bottoms and apply a light coating of wax. Also clean the cam shafts and cam sleeves and very lightly oil. Also make sure the clamp levers are vertical before you try to move the component.

VIBRATION: All lathes will vibrate if you have out of balance work and run the speed too fast. For systemic vibration problems, start with the feet. All four feet should be carrying about the same weight. This is more important than having your lathe level. Settle the lathe as described elsewhere. Also use the hard rubber pads supplied with your lathe.

Another source of vibration is loose mounting of your work. Chucks and faceplates must seat on the spindle shoulder. Use a thin nylon washer between the spindle shoulder and the chuck or faceplate. If your chucks or faceplate won't seat, see the next section on spindle maintenance.

SPINDLE THREAD MAINTENANCE: Your faceplates and chucks should spin on and off freely. To do so, the threads on your spindle, chucks and faceplates must be clean and burr-free. Every time you put something on the spindle you should clean the spindle threads and the accessory being mounted with compressed air and visually inspect both items for debris. Put a drop of mineral oil (won't stain wood) on the spindle every now and then.

MORSE TAPER MAINTENANCE: Morse tapers need to be clean and burr-free to work properly. If they are not, the inserted component can spin which may damage both the internal and external tapers. The “TaperMate” Morse Taper Cleaner” available at many woodturning supply houses is a good at getting soft debris out of internal tapers. If your spindle or tailstock tapers have burrs or galls get a Morse taper hand reamer of the appropriate size. Do not attempt to fully restore a shiny internal surface with the reamer, just get the high spots off. Use cutting oil liberally. For the external surfaces, light passes with a smooth-cut file or a little sandpaper is usually all you need. Concentrate on the burrs, and leave good surfaces alone.

FINISH: The lathes are powder coated and the parts are either semi-gloss black or Silvervein. Powder coating is quite durable, but not indestructible. Certain solvents can negatively affect the finish. We have been told that Camphor, a wood common in the southeast, can also negatively affect the powder coat finishes. Silvervein is hard to touch up, so if you want to keep the lathe nice, cover surfaces when using glues and finishes.

TAILSTOCK QUILL: The tailstock quill should turn in and out easily. If your quill is not going in and out easily, remove the quill and clean and lubricate the mechanism. Spray grease is handy for the threads and inside of the quill hole. Sometimes burrs will form along the groove that the spindle lock rides in. It doesn't take much of a burr to cause the quill to bind. Take a small file and remove the burr. Filing a small chamfer on the edge of the groove is also a good idea.

LATHE MAINTENANCE TOOL KIT: Here are a few things to have in your tool kit to keep your lathe in good order:

- Paraffin or paste wax for lathe bed and underside of banjo, tailstock and sliding headstock
- Sharp three corner file with one side ground safe for deburring spindle threads
- Bottoming tap the same size as your spindle for cleaning chuck and face plate internal threads
- Spray grease for quill
- Scotch Brite for cleaning lathe bed and underside of banjo, tailstock and sliding headstock
- Small stiff brush for cleaning belt and pulleys
- Mineral oil for lubricating spindle threads
- Light lube oil, like WD-40 or 3-in-1
- TaperMate Morse Taper Cleaner or similar
- Morse taper reamer
- Single cut file (aka: mill file or bastard file). A sharp one.
- General hand tools needed to maintain your lathe (wrenches, screwdrivers, Allen wrenches).

! Please see our website information section for a more complete discussion of lathe maintenance !

Robust Seven Year “Head to Tail” Lathe Warranty

WHAT IS COVERED: We will, at any time within seven years from the date of delivery, repair or replace (our option) any mechanical or electrical part which is defective in materials or workmanship on any of our lathes. This includes headstock bearings.

WHO IS COVERED: The initial purchaser and one subsequent owner.

IF YOU HAVE A WARRANTY CLAIM: In all cases, return authorization must first be obtained by calling us. At its option, Robust may send a service person to the owner’s location. If the tool must be returned to Robust, the customer is responsible for packaging, shipping and insurance expenses. Insurance on return shipments is important as Robust Tools, LLC cannot be responsible for items that do not arrive or were damaged in shipping. Robust will pay insurance and return shipping to the customer via the lowest cost means.

OTHER WARRANTY INFORMATION: This warranty does not cover failures due directly or indirectly to misuse, abuse, negligence or accidents, normal wear-and-tear, improper repair, alterations or lack of maintenance. Robust lathes are designed to turn wood. Working with other materials may void the warranty.

Robust Tools, LLC makes no other warranty, express or implied. No agent, representative, distributor, dealer, or employee of Robust Tools, LLC has the authority to increase or otherwise change the obligations or limitations of this warranty. The obligations of Robust Tools, LLC in its sole discretion under this warranty shall be limited to the repair or replacement of any Robust lathe, tool or accessory that is found to be defective.

Robust Tools, LLC. is not liable for incidental or consequential damages, including injury or death. Some states do not allow the exclusion or limitation of incidental or consequential damages, so the above limitation or exclusion may not apply to you. This warranty gives you specific rights, and you may also have other rights, which vary, from state to state, province to province, or country to country.

For your own records, you may want to record your information here:

Lathe Model _____ Serial Number _____ Purchase Date _____ Delivery Date _____

The serial # can be found on the back of the lathe on the tailstock end.