

Instruction Manual

Stainless Steel Vacuum Carafe
Model No. SH-HB / SH-HC

Please read these instructions before use,
 and keep for future reference.

● Be sure that all parts are attached firmly before each use.

Name of Each Part

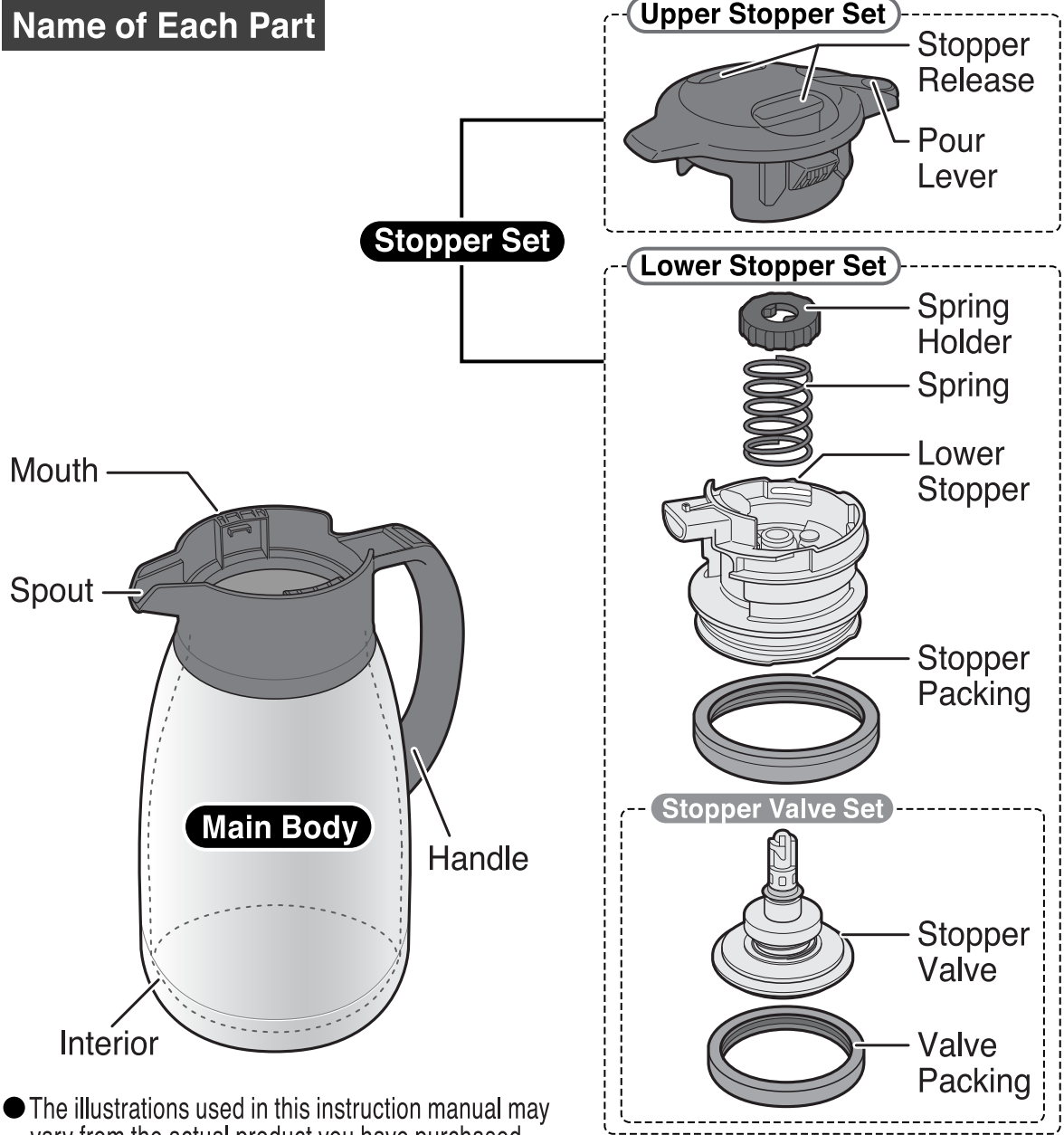

● The illustrations used in this instruction manual may vary from the actual product you have purchased.

SH-HB / SH-HC(E/K) / D

Important Safeguards

Please follow these instructions to prevent scalding, deterioration and discoloration of beverages, and malfunction or staining of the Carafe.

Keep out of the reach of infants and small children. Do not allow them to play with this product.

Mishandling may cause injury or scalding.

Do not use in direct sunlight or near open flames from sources such as stoves.

Doing so may cause scalding, deformation or discoloration of the Carafe.

Leave 1 cm (1/2 inch) of space on top when filling the Carafe.

Closing the Stopper Set with too much beverage may cause overflow. It may also cause leaks later.

Beverage Level

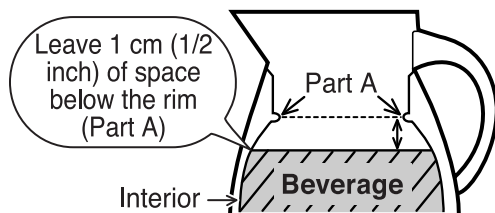

Do not press the Pour Lever with the Carafe close to your face or with the Spout tilted toward you.

Hot beverages or steam may suddenly come out and cause scalding.

Do not use the Carafe if it loses its heat retention properties.

The outside of the Main Body will become very hot when filled with hot beverage and may cause burns.

Do not remove the sticker on the bottom of the Main Body.

Doing so may cause rust or pinholes.

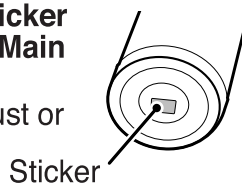

Do not disassemble the Main Body.

Use only to keep beverages hot or cold.

This Carafe is for keeping beverages hot or cold.

Do not place inside moving vehicles when filled.

Doing so may cause burns, stains, or damage.

Hold the handle firmly when carrying the Carafe.

● **Do not tilt the Carafe or carry it on its side.**

Doing so may cause burns or stains.

● **Do not hold the Carafe by the Stopper Set or Pour Lever.**

The Carafe could fall, posing a hazard.

● **Do not press the Pour Lever while carrying the Carafe.**

Beverages may spill and cause burns or stain clothes.

Do not turn the Carafe on its side when filled with a beverage.

Hot beverages may leak and cause scalding or stains, even if the Pour Lever is closed.

Avoid dropping or hitting the Carafe against hard surfaces.

Damage to plastic parts or the stainless steel surface of the Carafe may reduce its ability to retain heat.

Do not place near open flames (from gas stoves) or on top of electric heaters or IH cooking devices.

Doing so may cause fire, burns, or damage.

When removing the Stopper Set, press the Pour Lever once to release steam before removing the Stopper Set.

Failure to do so may cause the Stopper Set to pop off and release steam, which may lead to injury or burns.

Always make sure that all packings and the Stopper Valve are attached during use.

Hot beverages may leak and cause scalding. It may also cause stains.

Always close the Stopper Set securely.

If the Stopper Set comes off, beverages may spill and cause burns.

Clean the Stopper Set, Stopper Valve, all packings, and the Interior immediately after every use.

Not cleaning thoroughly may cause the Main Body to rust, pinholes to form, or beverages to spoil. Additionally, mold may form if the Carafe is left unwashed.

Important Safeguards (continued)

Consume beverages within the same day to prevent spoilage.

Leaving a beverage in the Carafe for an extended period of time may cause spoilage and increase gas pressure inside the Main Body, causing the Stopper Set to pop off and beverages to spill, resulting in injury.

After attaching the Stopper Set to the Main Body, press the Pour Lever several times to make sure that the Lower Stopper Set is also correctly attached.

If the Stopper Set is not properly attached, beverage may leak and cause burns or stain clothing.

Do not fill the Carafe with the following:

- **Dry ice or carbonated drinks:**

The pressure inside the Main Body could rise, causing the Stopper Set to pop off and beverages to spill, resulting in injury.

- **Dairy products or fruit juice:**

If left inside for a long period of time, contents may spoil and increase gas pressure inside the Main Body, causing the Stopper Set to pop off, resulting in injury.

- **Liquids high in sodium such as soup or Kobu-cha:**

Although the liner is made of 18/8 stainless steel, salt could cause rust, resulting in loss of thermal insulation.

- **Fruit pulp or tea leaves:**

Contents could clog the Stopper Packing or cause leaks.

Warnings & Cautions

Do not allow a hot kettle to touch the mouth of the Main Body.

Doing so may cause burns if the Carafe is tipped over.

It may also cause scratches or deformation of the Carafe.

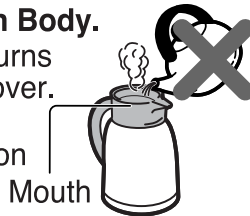

Do not scrape or rub the design on the Main Body with excessive force.

The design may come off.

When keeping hot drinks warm, the pressure inside the Main Body cause a small amount of steam to escape through the Stopper Set, making a hissing sound. If the sound continues, press the Pour Lever to release any steam.

It is designed to release pressure for safety purposes, and does not indicate a malfunction.

Hot tea may discolor when stored for a long period of time. We recommend filling the Main Body with hot water, and using a small teapot or tea bags to brew tea.

Do not attach parts other than those specifically designed for use with this product.

Doing so may cause leaks or breakage.

After cleaning the Stopper Set, shake it well to remove excess water, then wipe it thoroughly.

Water left inside may leak out.

Do not force large ice cubes into the Carafe.

Doing so may cause deformation or damage the Carafe.

Do not place cans or bottles inside the Main Body.

Doing so may cause deformation or damage the Carafe.

The rattling noise that may be heard when the Carafe is shaken comes from the metallic foil used in the vacuum insulation to increase heat (cold) retention and does not indicate a malfunction.

Using the Carafe

● Before use, rinse the Stopper Set and the Interior thoroughly with lukewarm water.

- The first time you use the product you may notice the smell of plastic. This is normal and will gradually fade away.
- Always make sure that all parts of the Stopper Set are properly attached before use.
Failure to do so may cause contents to leak. (See pg. 7-8 “Reassembling the Stopper Set” for details.)
- Keep the Carafe upright when transporting it.



To keep pressure from building up inside the Carafe, there is a slight gap in the Stopper Set. Exercise caution as contents may leak from the Spout if the Carafe is tilted, even if the Pour Lever is not pressed down.

1 Remove the Stopper Set.

① Hold the handle with one hand and pinch the Stopper Release.

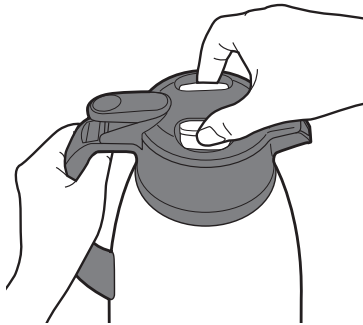

② Pull the Stopper Set out while pinching.

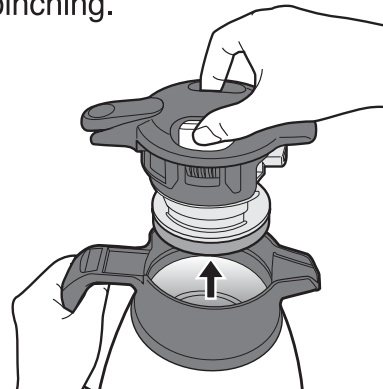

2 Fill the Carafe and attach the Stopper Set.

Press the center of the Stopper Set straight down.

- Firmly push the Stopper Set until the Stopper Release on both sides click into place.

[Caution]

Make sure to press down on the center of the Stopper Set. You may pinch or injure your finger or hand between the Stopper Set and the Main Body.



For better heat retention, preheat (precool) the Main Body for about 1 minute before filling with your beverage.

Beverage Level

Leave 1 cm (1/2 inch) of space below the rim (Part A)

Interior

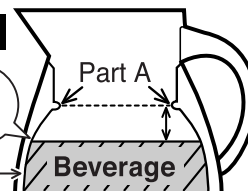

Using the Carafe (continued)

3 Pouring beverages:

① Hold the handle and press down the Pour Lever while keeping the Main Body upright.



② Keep the Pour Lever pressed down and tilt the Carafe to pour.

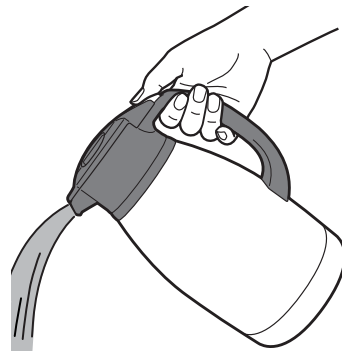

4 After pouring:

① While holding and pressing the Pour Lever, stand the Carafe upright.



② Release the Pour Lever.

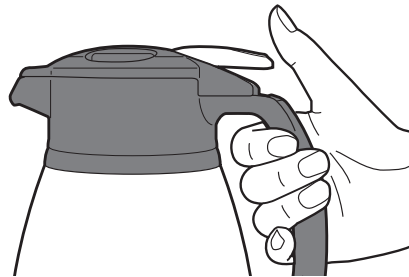

Caution

If the Pour Lever is released while the Carafe is tilted, beverages will sit in the Stopper Set and cause leakage during use, resulting in burns or stains.

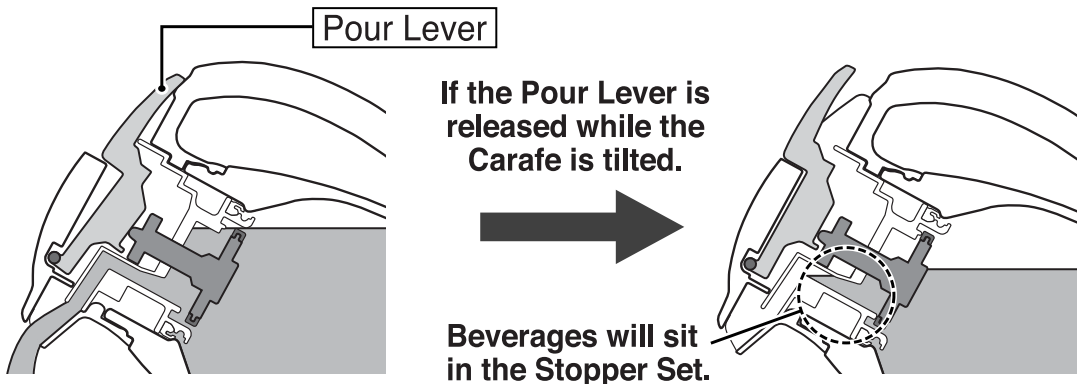

Disassembling the Stopper Set

1 Remove the Upper Stopper Set.

- ① Hold the Upper Stopper Set and rotate the Lower Stopper Set in the direction indicated by the arrow.

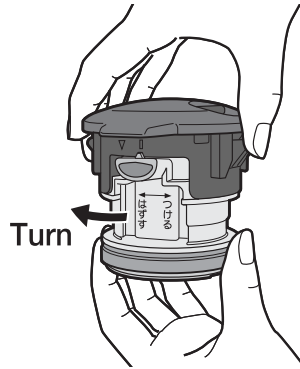

- ② Lift the Upper Stopper Set to remove.

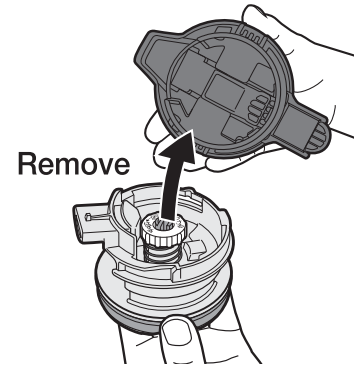

2 Remove the Spring Holder.

- ① Hold the bottom of the Stopper Valve Set with your finger so it does not move.

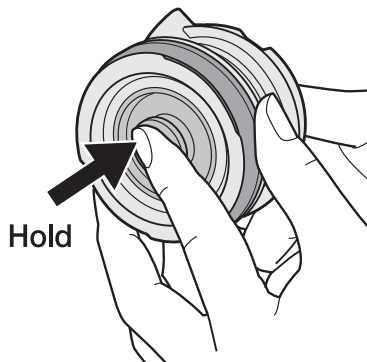

- ② While holding the bottom of the Stopper Valve Set, firmly hold and push down on the Spring Holder, turn it 90 degrees in the direction indicated by the arrow, and remove the Spring Holder and Spring.

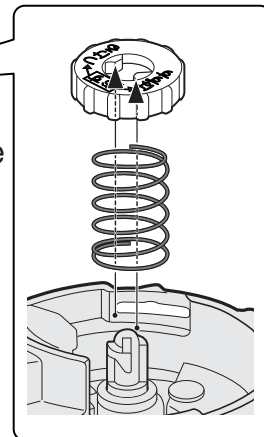
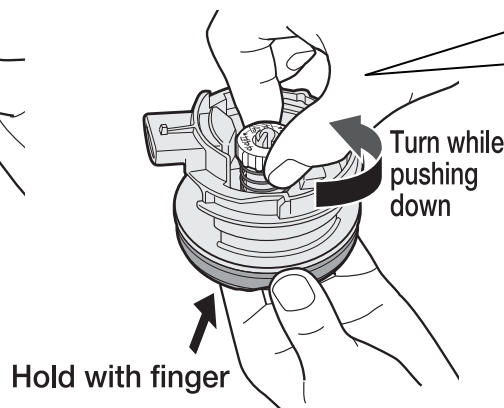

- The Spring may fly out if you do not hold the Spring Holder firmly.

3 Remove the Stopper Valve Set.

- Pull out the Stopper Valve Set from the bottom.

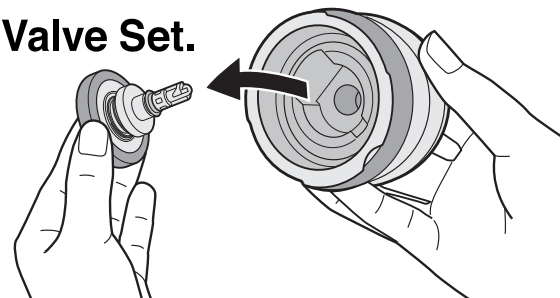

Disassembling the Stopper Set (continued)

4 Remove the Stopper Packing and Valve Packing.

① Push the Stopper Packing so that it is loose at the notch.

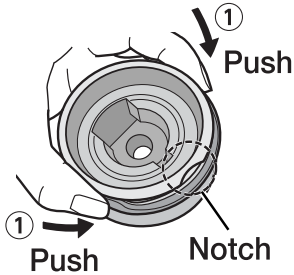

② Pinch the Stopper Packing at the notch and remove the Stopper Packing.

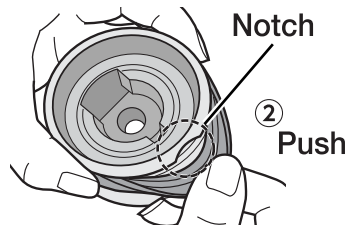

*Do not remove the smaller packing on the Stopper Valve Set.

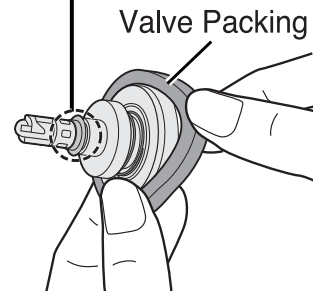

Reassembling the Stopper Set

1 Attach the packings.

Stopper Packing

Note the top and bottom of the packing.

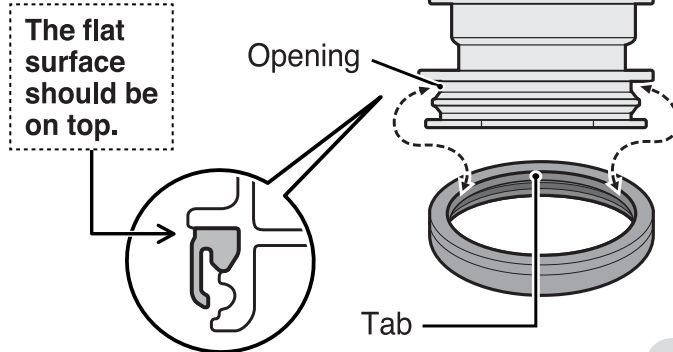

Valve Packing

There is no top or bottom.

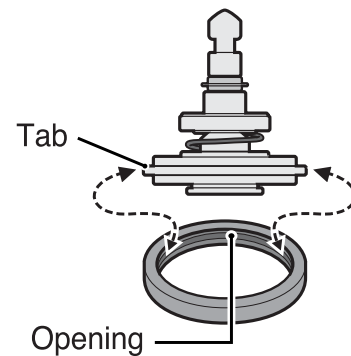

● After attaching the packings, press the packings from the outside in with your fingers. (The Carafe may malfunction or contents may leak if the parts are not attached properly.)

Reassembling the Stopper Set (continued)

2 Attach the Stopper Valve Set.

① Insert the Stopper Valve Set to the Lower Stopper Set, place the spring, then the Spring Holder.

*Make sure to position the Spring Holder so that the writing is on top.

② Hold the bottom of the Stopper Valve Set, push in the Spring Holder and rotate it 90 degrees in the direction indicated by the arrow to attach it to the Stopper Valve Set.

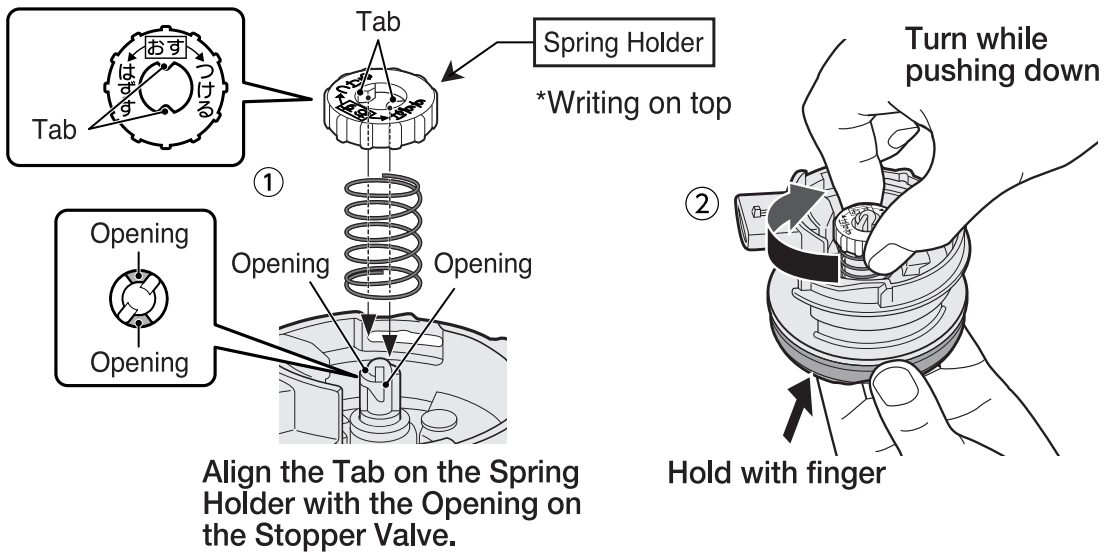

3 Attach the Upper Stopper Set.

① Align the “▼” symbol on the Upper Stopper Set with the Tab on the Lower Stopper Set.

② Turn the Lower Stopper Set in the direction indicated by the arrow and align the “|” symbol with the Tab on the Lower Stopper Set to attach.

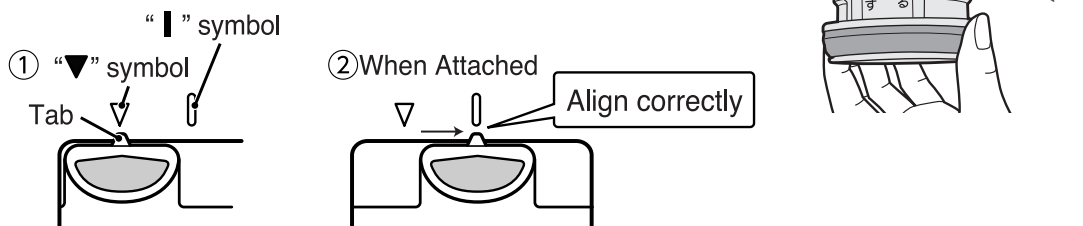

Taking Care of Your Carafe

Clean the product after each use to prevent odors, stain, mold, and to keep the product sanitary.

- Always disassemble the Carafe before cleaning. (See pg. 6-7)

Exterior Stopper Set	<ul style="list-style-type: none">① Wash with warm water and mild dishwashing liquid using a soft sponge.② Rinse, shake a few times, gently wipe away any moisture, and allow to dry.● Disassemble the Stopper Set and remove the Stopper Packing and Valve Packing first, then wash and dry. See pg. 6-7 "Disassembling the Stopper Set" for details.● Use a small brush sold in stores if necessary.
Interior	<ul style="list-style-type: none">① Wash with warm water and mild dishwashing liquid using a soft sponge with a handle.② Then rinse dry completely.

When Cleaning Your Carafe:

- Do not use a dishwasher or dish-dryer. Do not boil to sanitize.
- Do not clean using paint thinner, metal wire scrub brushes, scrubbing brushes that include abrasive cleaners, polishing powders, cleansers, eraser pads, or other similar items.
Doing so may damage the product.
- Do not use chlorine-based bleach. In addition, do not use any kind of bleach, even non-chlorine-based, to clean the outside of the Main Body. Bleach may damage the paint, print, or stickers on the Main Body.
- Do not soak in water for an extended period of time.
- If the product is not going to be used for an extended period, wash thoroughly with cold or lukewarm water and dry well. Store the product away from high temperatures and humidity.
High temperatures and humidity may damage the product.

To Remove Rust Spots and Water Stains:

You may find rust spots or water stains caused by impurities in the water. To remove these stains, fill the Main Body with hot water with 10% vinegar and allow to stand for 30 minutes to an hour without attaching the Stopper Set. Then wash the Interior thoroughly.

To Remove Coffee and Tea Stains:

To remove coffee and tea stains from the Interior and the Stopper Set, we recommend using Zojirushi's cleaning detergent SB-ZA01/SB-ZA01E. Always remove the Stopper Set when using SB-ZA01/SB-ZA01E.

- Contact Zojirushi Customer Service or your local dealer for further information.

We take care in only using materials that are safe and hygienic for food contact. However, if plastic parts become damaged or their surface becomes rough, please replace them for optimum performance. The Stopper Set, Stopper Valve Set, or Stopper Packing may need to be replaced due to time and wear. Please check them about once a year. When replacing parts, please record the model number and part name beforehand. Then contact either the store where you purchased the product or Zojirushi Customer Service. Replacement parts may be available for an additional charge.