

**Name of Each Part**

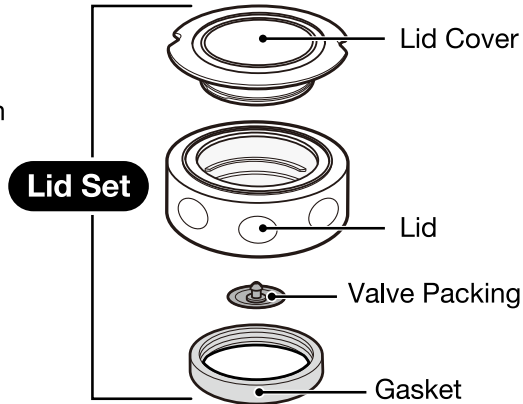
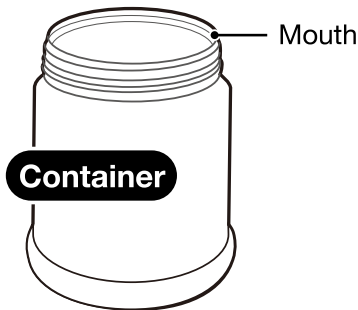

- The illustrations used in this instruction manual may differ from the actual product you have purchased.
- Please read these instructions before use, and keep for future reference.

**Warning**

• Please follow these instructions to prevent injury, scalding, accidents, malfunction or performance deterioration of the product, spilling of foods or beverages, spoilage, etc.

**Do not allow infants or small children to use this product. Keep out of the reach of infants and small children.**

**Always make sure that the parts are properly attached during use.**

**Do not attach parts other than those specifically designed for this product.**

**Do not use the product if its thermal insulation performance has deteriorated.**

**When containing hot foods or beverages:**

- Do not tilt the Container suddenly when drinking hot foods or beverages.
- When pouring hot foods or beverages into the Container, be careful not to let it tip over.
- The interior of the Lid Set will become hot to the touch. Do not use the product without the Lid Cover attached.

**Do not use if water enters the interior of the Vacuum Layer.**

If the internal water seeps out from the Vacuum Layer, consuming it may cause illness.

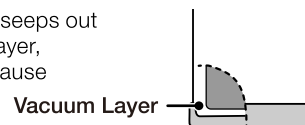

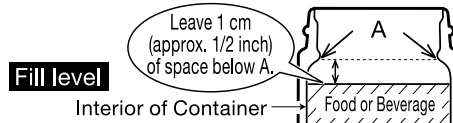

**Fill the Container only up to the level shown in the illustration.**

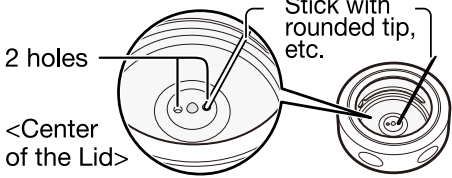

**Do not disassemble the product (other than parts designed to be disassembled).**

**Do not heat in a microwave, as doing so may cause sparks.**

<p><b>Do not place near open flames (from gas stoves, etc.), on top of electric heaters, or IH cooking devices, as doing so may cause a fire or malfunction.</b></p>	<p><b>Avoid using to keep food hot or cool for extended periods. Wash Container, Lid and Gaskets immediately after use.</b></p>
<p><b>Do not eat or drink out of the product while driving.</b></p>	<p><b>Always make sure cold soups or foods and beverages containing dairy products are cooked (heated) through before placing them in the Container.</b></p>
<p><b>This product is for keeping foods and beverages hot or cold. Do not use it for any other purposes.</b></p>	<p><b>Foods with strong odors or colors (curry, kimchee and pickled daikon radish, or shiso, spinach, carrots and other brightly colored vegetables) may cause the product to absorb odors or may discolor the Lid Set. Wash the Container and other parts immediately after use. (While the stains may not be completely removed, the product can be used without problem.)</b></p>
<p><b>Do not hold the product by the Lid Set when carrying because the product may fall and cause injuries.</b></p>	<p><b>Avoid leaving in direct sunlight for an extended period.</b></p>
<p><b>Follow these instructions when placing salads/fruit in the Container.</b></p> <ul style="list-style-type: none"> <li>• Use fresh (just purchased) salads/fruit. Wash well under running water before using.</li> <li>• Wash hands thoroughly before preparing foods.</li> <li>• Avoid using kitchen knives and chopping boards which have been used for meat or fish. If you do use such knives or boards for salads/fruit, disinfect them beforehand.</li> <li>• Cut salads/fruit and cool well in the refrigerator before placing in the Container.</li> </ul>	<p><b>Make sure food or beverage does not leak before using the product.</b></p>
<p><b>Never put the following into the product:</b></p> <ul style="list-style-type: none"> <li>• Dry ice or carbonated drinks</li> <li>• Perishable fresh foods (uncooked meat, seafood, dairy products, eggs, etc.)</li> </ul>	<p><b>Avoid dropping or hitting against hard surfaces.</b></p>
<p><b>Do not heat the product from the outside, even when the Lid Set is difficult to remove.</b></p> <p>Doing so may cause a buildup of pressure inside the product, which can lead to an accident such as the Lid Set flying off. If the Lid Set is difficult to remove, remove the Lid Cover and push a stick with a rounded tip or similar tool into one of the two holes in the center of the Lid to release the pressure.</p>	<p><b>Do not place near heat sources such as gas stoves, ovens, and heaters, as doing so may cause deformation or discoloration of the product.</b></p>
	<p><b>Never remove the sticker on the bottom of the Container.</b></p> 
<p><b>Consume food or beverages as soon as possible (within 6 hours) and finish them in one sitting.</b></p>	<p><b>Break ice cubes into smaller pieces, as failure to do so may cause deformation of the Container.</b></p>
	<p><b>Do not place cans, bottles, etc. inside the Container.</b></p>
	<p><b>Place the product vertically when carrying it in a bag to prevent leakage or condensation.</b></p>
	<p><b>Do not scratch or rub the design on the outside of the Container strongly using fingernails or hard objects, as this may cause the design to come off.</b></p>

**Note:** The rattling noise that may be heard when the Container is shaken comes from the metallic foil used in the vacuum insulation to increase heat (cold) retention, and does not indicate a malfunction.

**How to Use:**

**How to Disassemble the Lid Set:**

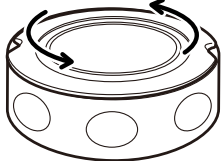
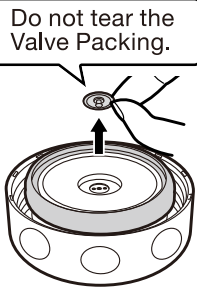
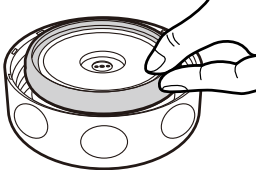
<p><b>1 Remove the Lid Cover by turning it as shown in the illustration.</b></p> 	<p><b>2 Remove the Valve Packing.</b></p> <p>Do not tear the Valve Packing.</p> 	<p><b>3 Remove the Stopper Gasket.</b></p> 
--------------------------------------------------------------------------------------------------------------------------------------------------------------------	-------------------------------------------------------------------------------------------------------------------------------------------------------------------	--------------------------------------------------------------------------------------------------------------------------------

**How to Assemble the Lid Set:**

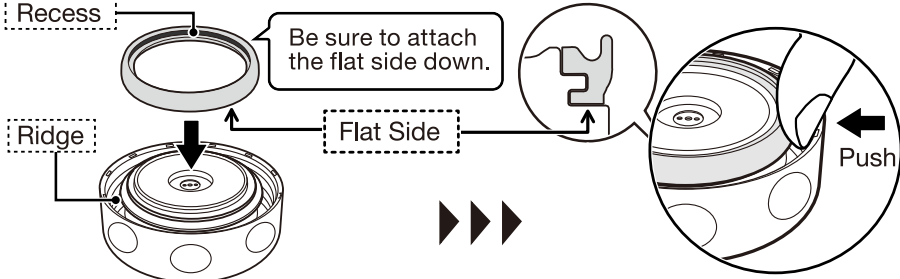
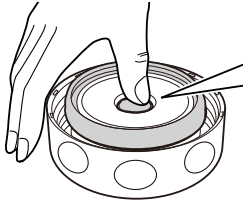
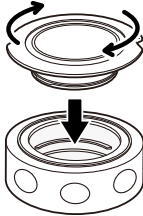
<p><b>1 Attach the Stopper Gasket.</b></p> <p>Line up the recess in the Stopper Gasket with the ridge on the Stopper, and, firmly applying pressure from the outside, push it into place.</p> 	
<p><b>2 Attach the Valve Packing.</b></p> <p>As shown in the illustration, push the projection on the Valve Packing securely into the hole in the center of the Lid.</p>  <p>Please make sure to fit the Valve Packing in the center hole.</p> <p>Do not leave any foreign matter or dirt under the Valve Packing or in the attachment site.</p>	<p><b>3 Attach the Lid Cover by turning it as shown in the illustration.</b></p> 

## How to Take Care of Your Product:

- Thoroughly clean the product before use.
- When you first use the product, there may be a plastic smell. However, this will become less noticeable with use.
- Clean the product after each use to prevent odors and mold, and to keep the product sanitary.
- Always disassemble the product before cleaning.

### When Cleaning Your Product:

- Do not boil or use a dishwasher or dish-dryer.
- Do not clean using paint thinner, polishing powders, abrasive cleansers, scrub brushes (nylon, metal wire, etc.), melamine sponges, the nylon side of an abrasive sponge, or any similar items.
- Do not use bleach as it may damage the product.  
Zojirushi's designated cleaning detergent SB-ZA01E may be used to clean the interior of the Container, the Lid, and the Gaskets.
- The Container is fully washable, but do not soak it in water for an extended period of time.
- If the product is not going to be used for an extended period, wash thoroughly and dry well. Store the product away from high temperatures and humidity.

### Regular Care

- ① Using mild kitchen detergent diluted with lukewarm water, wash the Lid Set and the outside of the Container with a sponge and the inside of the Container with a soft sponge with a handle.  
Use a small brush if necessary.
  - ② Rinse, wipe away remaining water, and leave to dry thoroughly.
- Streaks or smudges caused by rubbing on the coated portion of the Container that cannot be removed by the above method can be removed using a soft eraser.

### What to Do If Rust Spots Form on the Container

- ① Fill the Container with hot water with 10% vinegar without attaching the Lid Set.
- ② After 30 minutes to an hour, wash the interior thoroughly.

### What to Do If the Product Absorbs Odors

<b>Container Lid</b>	Remove the Lid Set and use Zojirushi's cleaning detergent SB-ZA01E. (Contact Zojirushi Customer Service or your local dealer for further information.)
<b>Gaskets</b>	Boil for 10 minutes in water with approximately 10% vinegar. After rinsing, wipe off moisture thoroughly to dry.

### Replacing the Lid and Gaskets:

We take care in only using materials that are safe and hygienic for food contact. However, if plastic parts become damaged or their surface becomes rough, please replace them for optimum performance. The Lid and other consumable parts may need to be replaced due to time and wear. Please check them about once a year. When replacing parts, please record the model number and part name beforehand. Then contact either the store where you purchased the product or Zojirushi Customer Service. Replacement parts may be available for an additional charge.