

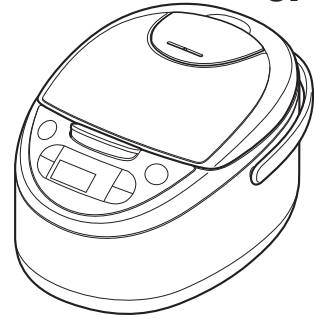

JAX-R
JAX-S ①



JAX-R18A
JAX-S10A
JAX-S18A

For household use

Rice Cooker / Warmer

OPERATING INSTRUCTIONS

Thank you for purchasing this TIGER rice cooker/warmer.
Please read these instructions carefully before use and observe them during use.

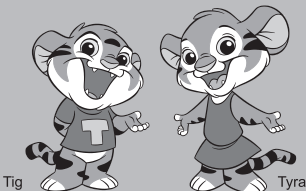

IMPORTANT SAFEGUARDS

When using the appliance, basic safety precautions should always be followed including the following:

1. Read all instructions.
2. Do not touch hot surfaces. Use handles or knobs.
3. To protect against electrical shock, do not immerse cord or plug in water or other liquid.
4. Close supervision is necessary when the appliance is used by or near children.
5. Unplug from outlet when not in use and before cleaning. Allow to cool before putting on or taking off parts.
6. Do not operate the appliance with a damaged cord or plug or after the appliance malfunctions or has been damaged in any manner. Return appliance to the nearest authorized service facility for examination, repair, or adjustment.
7. The use of accessory attachments not recommended by the appliance manufacturer may cause injuries.
8. Do not use outdoors.
9. Do not let cord hang over edge of table or counter, or touch hot surfaces.
10. Do not place the appliance on or near a hot gas or electric burner, or in a heated oven.
11. Extreme caution must be used when moving the appliance containing hot oil or other hot liquids.
12. Always attach plug to the appliance first, then plug cord into the wall outlet.
To disconnect, turn any control to "off", then remove plug from wall outlet.
13. Do not use the appliance for other than intended use.
14. Risk of electric shock, cook only in removable container.

SAVE THESE INSTRUCTIONS

Servicing should be performed by an authorized service representative.
This appliance is intended for household use.

1. A short power cord (or detachable power cord) is provided to reduce the risks of becoming entangled in or tripping over a longer cord.
2. Longer detachable power cords or extension cords are available and may be used if care is exercised in their use.
3. If a longer detachable power cord or extension cord is used:
 - a. The marked electrical rating of the extension cord should be at least as great as the electrical rating of the appliance.
 - b. The extension cord should be arranged so that it will not drape over the countertop or tabletop where it can be pulled by children or tripped over unintentionally.

The appliance is not intended for use by persons (including children) with reduced physical, sensory or mental capabilities, or lack of experience and knowledge, unless they have been given supervision or instruction concerning use of the appliance by a person responsible for their safety.

Children should be supervised to ensure that they do not play with the appliance.

The following instructions are applicable to 120V only:

This appliance has a polarized plug (one blade is wider than the other). To reduce the risk of electrical shock, this plug is intended to fit into a polarized outlet in only one way. If the plug does not fit fully into the outlet, reverse the plug. If it still does not fit, contact a qualified electrician. Do not attempt to defeat this safety feature.

Contents

1	Important Safeguards.....	4
2	Names and Functions of Component Parts	9
	Menu options and features	11
	Tips on making delicious rice.....	12
3	Before Cooking Rice.....	14
4	How to Cook Rice	16
	Cooking time guidelines	17
5	Once the Rice Is Done Cooking.....	18
6	Setting the Timer.....	19
7	Keeping the Rice Warm	21
8	Reheating Cooked Rice.....	22
9	Cooking Rice and Side Dishes Together ("Synchro-Cooking" Menu).....	23
10	Slow Cooking ("Slow Cook•Steam" Menu)	25
11	Steaming Food ("Slow Cook•Steam" Menu)	27
12	Cleaning and Maintenance.....	30
13	If Rice Does Not Cook Properly.....	36
14	If Synchro-Cooking Does Not Go As Expected.....	38
15	If Slow Cooking Does Not Go As Expected.....	39
16	Troubleshooting.....	40
	If these indications appear.....	41
	Setting the present time	42
	Specifications.....	43
	In case of a power outage	43
	Purchasing consumables and optional accessories	43

1 Important Safeguards

Read and follow all safety instructions before using the rice cooker.

- The WARNINGS and CAUTIONS described below are intended to protect the user and other individuals from physical harm and household damage. To ensure safety, please follow carefully.
- Do not remove the caution/warning seal attached to the appliance.

Safety instructions are classified and described according to the level of harm and damage caused by improper use, as shown below.

Warning

This symbol indicates there is a possibility of death or serious injury^{*1} when the unit is improperly handled.

Caution

This symbol indicates there is a possibility of injury^{*2} or damage to property^{*3} when the unit is improperly handled.

*1 "Seriously injury" is defined here as loss of sight, burns (high and low temperature), electric shock, broken bones, poisoning, or other injuries severe enough to require hospitalization or extended outpatient care.

*2 "Minor or moderate injury" is defined here as a physical injury, burn, or electric shock which will not require hospital stay or extended outpatient care.

*3 "Damage to property" is defined here as damage towards a building, furniture, or pets.

Description of Symbols



The  symbol indicates a warning or caution. The specific details of the warning or caution are indicated inside the symbol or in an illustration or text near the symbol.



The  symbol indicates a prohibited action. The specific details of the prohibited action are indicated inside the symbol or in an illustration or text near the symbol.



The  symbol indicates an action that must be taken or an instruction that must be followed. The specific details of the action or instruction are indicated inside the symbol or in an illustration or text near the symbol.

Warning

General safety precautions



Disassembly is prohibited

Do not attempt to disassemble, repair, or modify the product. Repairs should only be performed by a qualified service representative.

Doing so may result in fire, electric shock, or injury.



Stop using the appliance immediately if you incur any malfunction or trouble.

Not doing so may result in fire, electric shock, or injury.

Examples of trouble:

- The power cord and/or plug become abnormally hot.
- Smoke is emitted from the rice cooker or a burning odor is detected.
- The rice cooker is cracked or there are loose or rattling parts.
- The inner pot is deformed.
- There are other problems or abnormalities.

Immediately unplug the power cord from the outlet and contact your local dealer for servicing.

Warning

Environment for use



Do not use on an unstable surface, or on a table or rug that is vulnerable to heat.

Doing so may result in fire or damage to the table or mat.



Do not use the rice cooker on a sliding tabletop that can not easily bear its weight.

Falling from the tabletop may result in injury, burns, or malfunction of the unit itself.

Before using the rice cooker, confirm that the sliding tabletop is sufficiently able to bear its weight.

Who should use the rice cooker



Do not allow children to use the appliance by themselves and do not put within reach of infants or toddlers.

Failing to do so may result in burns, electric shock, or injury.



Do not let infants or children lick the electric sockets or fixtures.

Doing so may result in electric shock.



This appliance is not intended for use by persons with physical difficulties or lack of experience and knowledge—unless they have been given supervision or instruction concerning to the use of the appliance by a person responsible for his/her safety.

Unsupervised use may result in burn, electric shock, or injury.

Using the rice cooker



Do not use this product in anyway not described in the operating instructions or supplied COOKBOOK.

Steam or contents may spray out causing burns or other injuries.

(Examples)

- Heating ingredients inside of plastic cooking bags, etc.
- Using parchment paper to cover food in the rice cooker.

Power supply



Use only rated voltage power.

Use of any other power supply voltage may result in fire or electric shock.



Use an electrical outlet rated 7 A or higher and do not plug in other devices at the same time.

Connecting other devices in the same outlet may cause the outlet to overheat or result in fire.

Power cord and plug



Do not damage or use a damaged power cord.

Do not forcefully bend, twist, fold, or modify the cord.

Do not place near high temperature surfaces or under/between heavy objects. A damaged power cord can cause fire or electric shock.



Wipe the plug thoroughly in the case dust or other foreign objects are collected.

This is to avoid fire.



Firmly insert the plug into the outlet to avoid electric shock, shorting, smoke, or fire.



Do not use the product if the power cord or plug is damaged or the plug is loose in the outlet.

This is to avoid electric shock shorting, or fire.



If the supply cord is damaged, it must be replaced by a special cord or assembly available from the manufacturer or its service agent.



Do not plug in or unplug with wet hands.

This is to avoid electric shock or injury.

Do not touch the unit with wet hands

Warning

-  **Do not expose the plug to steam.**
Doing so may result in electric shock or fire. When using the product on a sliding table, be careful not to expose the product to steam.

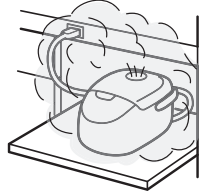

Handling the rice cooker



-  **Do not immerse the appliance in water, or pour water into the appliance;**
Never immerse this is to avoid short circuits, electric shocks, and malfunctions.
the unit in water or other liquid

-  **Do not insert any metal objects the air inlet or air outlet, or any gaps between parts.**
Doing so may result in electric shock or malfunction.

Starting to cook



-  **Do not use the cooking plate without the inner pot.**
Doing so may result in fire, smoke, or burns.

During and after cooking

-  **Never open the lid during cooking.**
Doing so may result in burns.
-  **Do not place your face or hands near the steam vent.**
Doing so may result in burns. Be especially careful to keep out of reach of infants and children.

Caution

General safety precautions

-  **Handle the rice cooker with care.**
Dropping the rice cooker or exposing it to a strong impact may result in injury or malfunction of the unit itself.
-  **Only use the cooking plate supplied with this rice cooker.**
Using another cooking plate may result in fire or burns.
-  **Household use only.**
This appliance is intended to be used in household and similar applications such as:
 - staff kitchen areas in shops, offices and other working environments
 - farm houses
 - by clients in hotels, motels and other residential type environments
 - bed and breakfast type environments

Environment for use

-  **Do not use near the wall or furniture.**
Steam and heat may cause damage, discoloration and/or deformation. Use the rice cooker at least 30cm away from walls or furniture. When using the appliance on a kitchen rack or cabinet, make sure the steam or heat is not trapped.



-  **Do not use a sliding tabletop with insufficient load bearing capacity.**
Otherwise the rice cooker may fall resulting injury, burn or malfunction. Check that the load bearing capacity is sufficient before use.

Caution

-  **Do not use the rice cooker near a heat source or where it may be splashed with water.**
Doing so may result in electric shock, short-circuiting, fire, or deformation or malfunction of the rice cooker.

-  **Do not use the rice cooker in a small space where the operation panel is exposed to steam.**
Steam and heat may result in deformation of the operation panel, and/or damage, discoloration, deformation, and/or malfunction of the rice cooker. When using the rice cooker on a sliding tabletop, pull the tabletop out so that the operation panel is not exposed to the emitted steam.

-  **Do not use the rice cooker on an IH cooking heater.**
Doing so may result in malfunction.

Power cord and plug



-  **Be sure to firmly hold the plug when removing from an outlet; this is to avoid electric shock, shorting, or fire.**





-  **Do not use multiple outlet receptacles; this is to avoid fire.**



Handling the rice cooker

-  **Use only the inner pot made exclusively for this rice cooker.**
Using any other pot may result in overheating or malfunction.
-  **Do not cook with the inner pot empty.**
Doing so may result in overheating or malfunction.
-  **Be careful of the escaping steam when opening the lid.**
Exposure to steam may result in burns.

-  **Unplug power cord when not in use.**
This is to avoid injury, scalds, electric shock, or fire caused by a short-circuit.
Unplug the power cord



-  **Do not touch the hook button while carrying the rice cooker.**
Doing so may cause the lid to open, resulting in injury or burns.
Do not touch

During and after cooking

-  **Do not touch hot parts during or immediately after cooking.**
Doing so may result in burns.
Do not touch

-  **Do not move the rice cooker while it is still cooking.**
Doing so may cause the contents to spill and cause burns.

Cleaning the rice cooker

-  **Wait until the appliance has cooled down before performing maintenance;** this is to avoid burns from hot surfaces.
-  **Do not wash the entire appliance.**
Do not pour water into the appliance or into the base of the appliance; this is to avoid short circuits and electric shocks.
-  **Do not handle the inner pot with your bare hands when the rice cooker is or has recently been in operation; use oven mitts to pick up the pot.**
Touching the hot pot may result in burns.

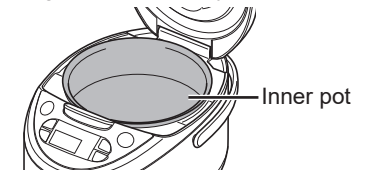

⚠ Caution

■ Following these safety instructions will allow the appliance to be used for many years.

- Remove any burnt rice or remaining grains of rice. Failure to do so may cause steam to leak or contents to boil over. This may result in malfunction or improperly cooked rice.
- Do not cover the rice cooker with a cloth or other object during cooking. Doing so may cause the rice cooker or the lid to become deformed or discolored.
- The holes on the rice cooker are designed to maintain its functions and performance. In extremely rare cases, dust or even insects may enter these holes and cause malfunction. To prevent this, a commercially available insect prevention sheet, etc., is recommended. If a malfunction does occur due to this problem, it will not be covered by warranty. Contact the place of purchase.
- The inner pot's fluorocarbon resin coating may wear and peel with extended use. This material is harmless to humans and this situation presents no hindrance to actual cooking or to the rice cooker's heat insulating capability. In the case you would like to purchase a new inner pan, you can do so by contacting the place of purchase.

- Strictly observe the following instructions to keep the fluorocarbon resin coating from scratching or peeling.
 - Do not place the inner pot directly over gas, electric, or IH stove top. Do not place in the microwave or oven.
 - Use the Keep Warm function for white rice only. Do not use for mixed or seasoned rice, etc.
 - Do not use vinegar inside the inner pot.
 - Use only the supplied spatula or a wooden spatula.
 - Do not use hard utensils such as metal ladles, spoons, or whisks.
 - Do not place a basket inside the inner pot.
 - Do not place tableware and other hard utensils or objects inside the inner pot.
 - Do not clean the inner pot with hard materials such as metal spatulas or nylon scouring sponges.
 - Do not use a dishwasher/dryer to clean the inner pot.
 - Be careful not to scratch the inner pot when washing rice.
 - If the inner pot becomes deformed, contact the place of purchase.

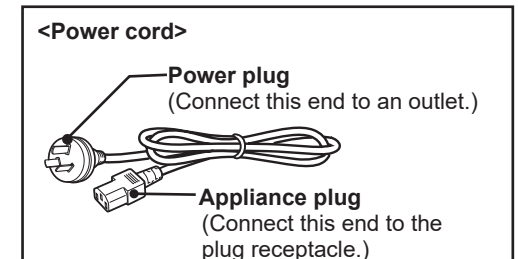
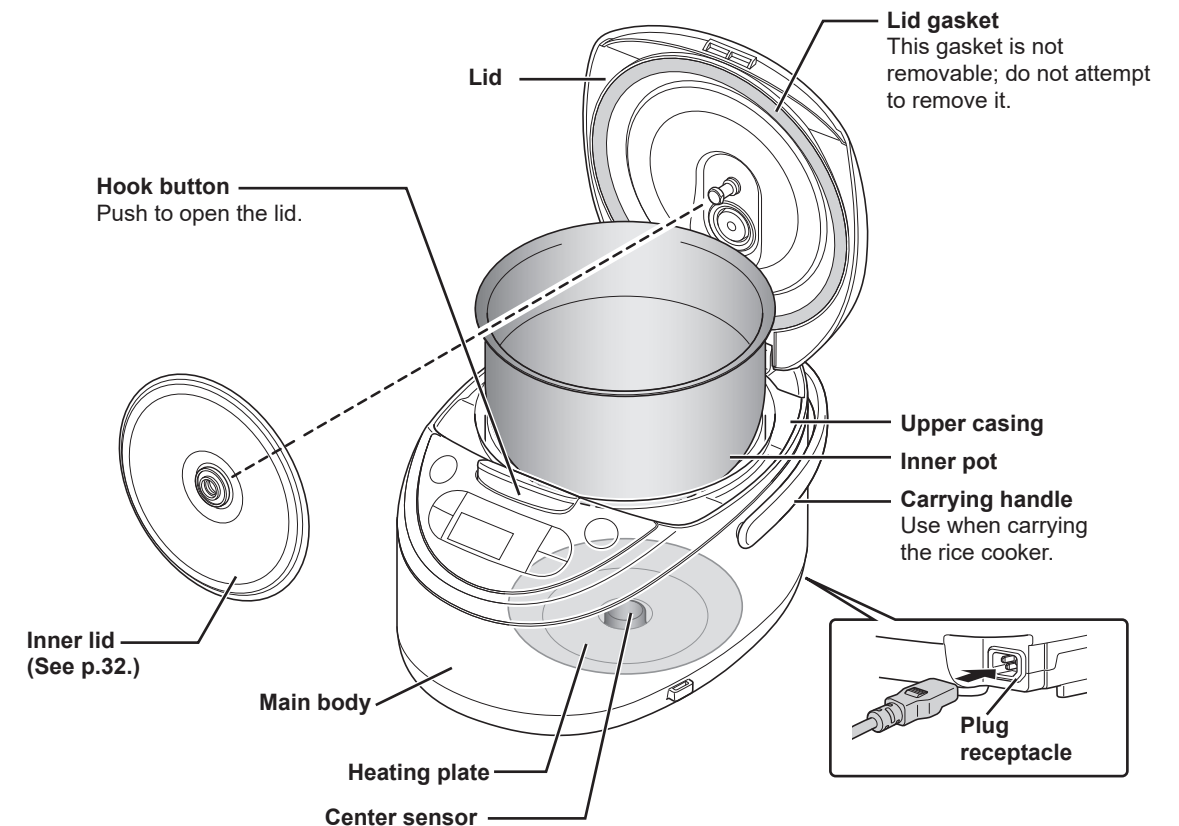
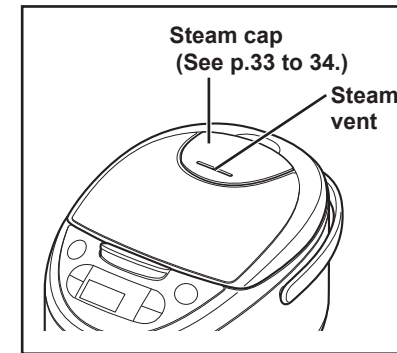

Operation panel

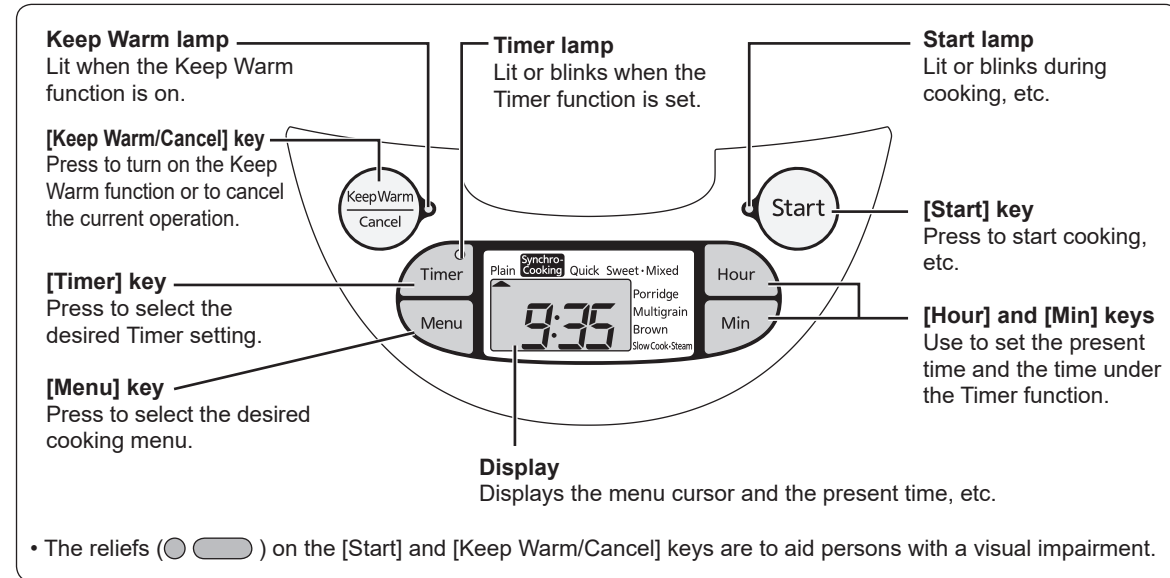

■ Checking the accessories

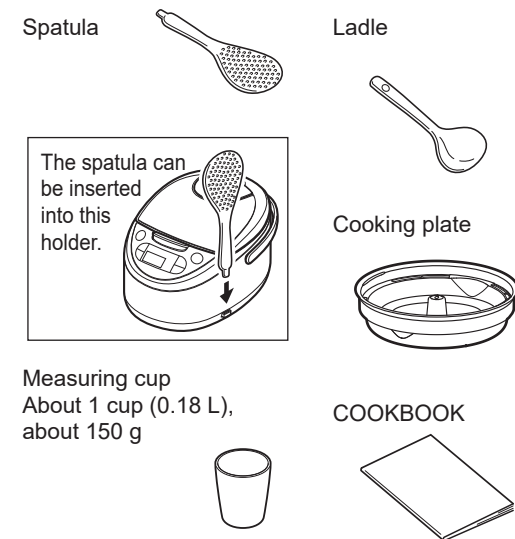

■ Sounds emitted by the rice cooker

The following sounds coming from the rice cooker during cooking, reheating, steaming, or when the Keep Warm function is on is normal and does not indicate a problem:

- A clicking sound (This is the sound of the microcomputer controller.)
- A scraping sound (This is the sound of metal contracting and rubbing together due to heat.)
- A sound like boiling water (Only during cooking or steaming.)

■ Checking the present time

The time is displayed in a 24-hour format. It should be adjusted if the correct time is not displayed. (See p.42.)

■ The lithium battery

The rice cooker has a built-in lithium battery that stores the present time and the preset timer settings even with the power plug disconnected.

- This lithium battery has a four-to-five-year life expectancy with the power plug disconnected.
- If the lithium battery runs out, "0:00" will blink on the display when the power cord is plugged back in. Normal cooking is still possible, but the present time, preset timer settings, and elapsed Keep Warm time will no longer be stored in memory when the power plug is disconnected.

Note

- Do not attempt to replace the lithium battery yourself.

To replace the battery, contact the place of purchase.

Menu options and features

Menu	Timer function availability	Keep Warm function availability	Feature
Plain	○	○	Select when cooking white rice.
Synchro-Cooking	—	△ *	Select when using the cooking plate to cook rice and side dishes together.
Quick	—	○	Select when quickly cooking white rice. Select when cooking long-grain rice.
Sweet•Mixed	—	△	Select when cooking seasoned rice or steamed glutinous rice.
Porridge	○	○	Select when making porridge.
Multigrain	○	△	Select when cooking grains like barley, foxtail millet, barnyard millet, black rice or red rice together with white rice.
Brown	○	△	Select when cooking brown rice or multi-grain-brown rice (brown rice mixed with grains).

See p.43 for cooking capacities.

△: Do not use the Keep Warm function because its flavor may not be maintained.

* Remove the cooking plate from the rice cooker before using the Keep Warm function.

Note

- When using the "Porridge" menu, the porridge can become pasty if kept warm for too long; serve as soon as possible.

Tips on making delicious rice



Read p. 14 to 15 for preparations before cooking rice, and p. 16 to 20 for how to cook rice.

Select high quality rice and store it in a cool location.

Choose freshly polished, glossy rice with a uniform grain size. Store in a cool, dark, well-ventilated place.

Carefully measure the rice with the supplied measuring cup.

One cup equals about 0.18 L.
Use the supplied measuring cup for rinse-free rice as well.

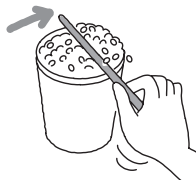

Wash the rice quickly.

Stir the rice around with your hand in a generous amount of water, pour out the water, and repeat until the water remains clear.

When cooking germinated brown rice, whole rice or semi-polished rice, select the "Multigrain" menu.

Cooking rinse-free rice

- Add the rinse-free rice and water, and then stir well from the bottom so that every individual grain of rice becomes immersed in the water. (Merely adding water to the rice will prevent it from soaking in the water and may result in improperly cooked rice.)
- If the added water turns white, we recommend you wash the rice thoroughly by replacing the water once or twice. (The water turning white is due to the starch in the rice and not its bran; however, cooking it with the starch left in the water may result in burned rice, the contents boiling over, or improperly cooked rice.)

Adding other ingredients to the rice

The total amount of ingredients should be no more than 70 g per cup of rice. Stir in any seasoning well and then add the extra ingredients on top of the rice. If other ingredients are to be added to the rice, be sure to use no more than the acceptable maximum amount (refer to the table below).

Menu	1.0 L (5.5-cup) type	1.8 L (10-cup) type
Sweet	3 cups or less	5 cups or less
Mixed	3 cups or less	6 cups or less
Porridge • hard	0.5 cup	1.5 cups or less
Brown	3 cups or less	5 cups or less

- Add water prior to adding the ingredients. Adding water after the ingredients will result in the cooked rice being too firm.

Add water according to the type of rice and your personal preference.

• Amount of water to add

If you choose to use more or less water than the recommended amount, do not deviate from that amount by any more than 1/3 of one line.

Menu	Corresponding scale (Use the corresponding scale on the inner pot as a guide and add water according to your personal preference.)
Plain Synchro-Cooking Quick Multigrain Mixed	"Plain" scale
Sweet (glutinous rice)	"Sweet" scale
Sweet (a mixture of glutinous and non-glutinous rice)	Between the "Plain" and "Sweet" scales
Brown	"Brown" scale
Porridge	Hard porridge: "Porridge • hard" scale Soft porridge: "Porridge • soft" scale

- When cooking rinse-free rice, use the "Plain" scale as a reference but add a little extra water (until it just covers the corresponding line).
- When making with the rinse-free rice, use "Porridge • hard" scale as a reference for hard porridge and the "Porridge • soft" scale for a soft porridge.
- When cooking germinated brown rice, whole rice or semi-polished rice, use the "Plain" scale as a reference.
- If the amount of water to add is specified on a package of germinated brown rice or multi-grain rice, follow those directions and add water according to your personal preference.

Cooking brown rice or multi-grain-brown rice mixed in with white rice

- If the rice to be cooked includes more brown rice or multi-grain-brown rice than white rice, use the "Brown" menu.
- If there is an equal amount of brown rice and white rice, or there is more white rice than brown rice, use the "Plain" menu. (The brown rice should be soaked separately for 1 to 2 hours before cooking.)
- If there is an equal amount of multi-grain-brown rice and white rice, or there is more white rice than multi-grain-brown rice, use the "Multigrain" menu. (The multi-grain-brown rice should be soaked separately for 1 to 2 hours before cooking.)

Cooking sweet rice

When cooking sweet rice, select the "Sweet•Mixed" menu.

Wash the rice, and then level it out so that all of the rice is under water.

Cooking grains together with white rice

- The amount of grains should equal less than 20% of the volume of the white rice.
- The grains should be placed on top of the white rice. Mixing them together may result in improperly cooked food.
- If you feel the cooked grains are too hard, soak the grains separately for about 1 hour prior to cooking.

Cooking grains together with brown rice

- Always use the "Brown" menu.
- The maximum acceptable amount for the combination of brown rice and grains is 3.5 cups with the 1.0 L type and 6 cups with the 1.8 L type.

Cooking long-grain rice

- When cooking long-grain rice, select the "Quick" menu. When cooking seasoned rice with various ingredients using long-grain rice, select the "Sweet•Mixed" menu. Selecting any other menu may result in the contents boiling over.

3 Before Cooking Rice

1 Measure the rice.

Always use the measuring cup supplied with the rice cooker (for rinse-free rice as well). A level filling of rice in the supplied measuring cup equals about 0.18 L.



- Fill the measuring cup as shown below.

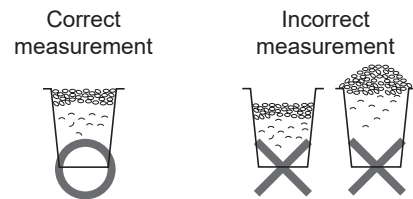

Note

- Always use the specified volume of rice (see "Specifications" on p.43). Otherwise the rice may not cook properly. If other ingredients are to be added to the rice, see p.12.

2 Wash the rice. (This can be done using the inner pot.)

For rinse-free rice, see p.12.

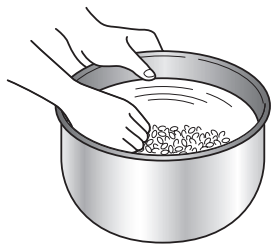

Note

- Do not use hot water (over 35°C) to wash the rice or when adding water. It may prevent the rice from cooking properly.
- Do not apply too much force while washing the rice. This could damage the inner pot and prevent rice from cooking properly.

3 Adjust the water level.

Place the inner pot on a level surface and adjust the water level to the appropriate line of the corresponding scale on the inside of the pot.



- The water level should be selected according to the type of rice and the selected cooking menu, but can be fine-adjusted to your personal preference. (See the guidelines on p.12.)

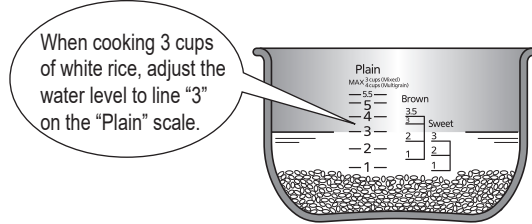

4 Wipe off any water and rice, etc.

<Outer surface and brim of the inner pot>



<Inside the rice cooker>

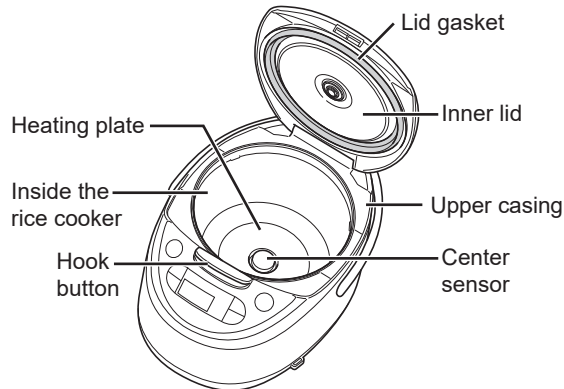

Caution

- Be sure to remove any rice or other material adhering to and around the heating plate, center sensor, upper casing, and the hook button. (See p.31.) Adhering material can prevent the lid from closing, allow steam to leak out during cooking, or enable the lid to open and the contents to spray out, resulting in burns or other injury.

5 Place the inner pot in the rice cooker.

- (1) Turn the inner pot slightly left and right so it is positioned correctly without any tilt.
- (2) Close the lid.

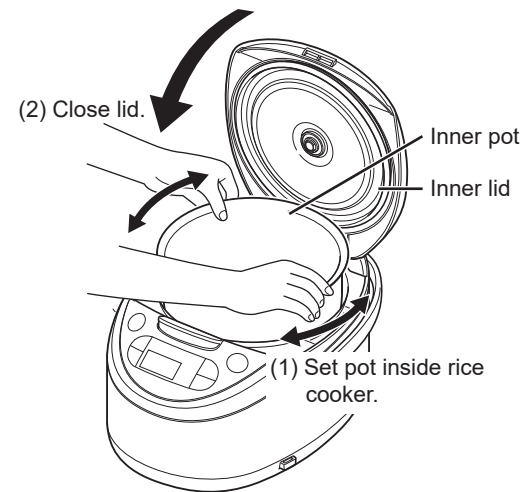

Note

- Make sure the inner pot is set securely into the rice cooker.

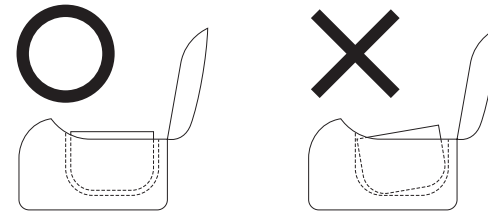

- Be careful not to touch an operation key when closing the lid.

6 Connect each end of the power cord to the specified locations.

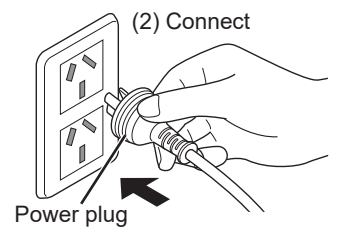
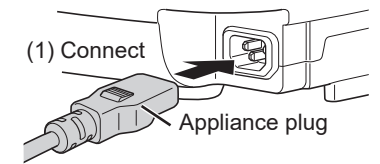

The power will turn on and the ▲ symbol will blink.

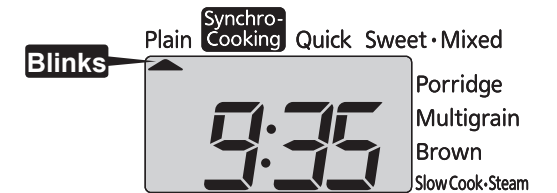

Note

- If the Keep Warm lamp is on, press the [KeepWarm/Cancel] key to turn off the lamp.

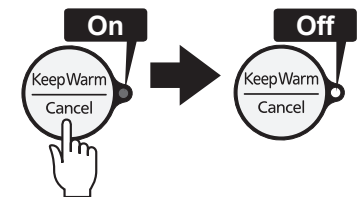

4 How to Cook Rice

1 Press the [Menu] key to select the desired menu.

Each time the [Menu] key is pressed, the selected menu will change in the order shown below.

The ▲ symbol will blink while the menu is being selected.

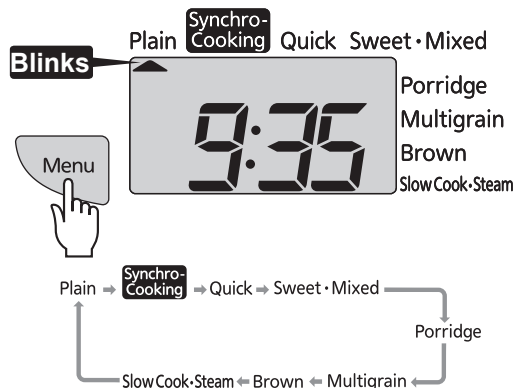

- It is not necessary to press the [Menu] key if the desired menu is already selected.

2 If you selected the “Porridge” menu, use the [Hour] and [Min] keys to set the desired cooking time.

- Each time the [Hour] key is pressed, the set time will increase by 5 minutes. Each time the [Min] key is pressed, that time will decrease by 5 minutes.
- The cooking time can be set to any 5-minute increment between 40 and 90 minutes.

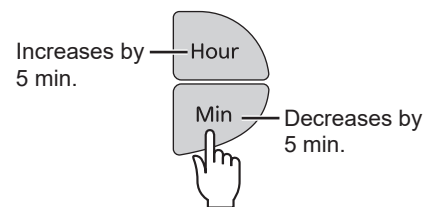

- The default setting is for 60 minutes. Adjust as desired.

3 Press the [Start] key.

The Start lamp will turn on. If you selected the “Plain” menu, a one-short, one-long beep alarm will sound. Otherwise, only a one-beep alarm will sound.

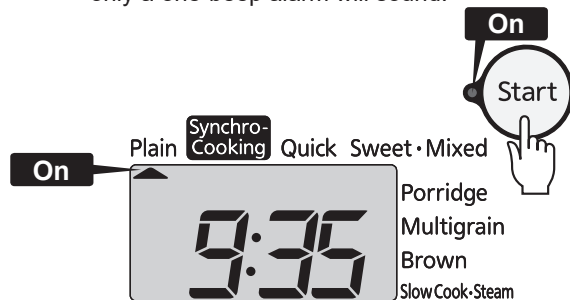

Cooking will start.

Appropriate amounts

See p.12 to 13 for the appropriate amounts of grains and ingredients.

Cooking time guidelines

Unit size	Menu	Plain	Synchro-Cooking	Quick	Sweet·Mixed	Multigrain	Brown
1.0 L (5.5-cup) type		44 to 57 min	44 to 56 min	26 to 45 min	37 to 61 min	47 to 59 min	65 to 79 min
1.8 L (10-cup) type		48 to 60 min	51 to 64 min	26 to 55 min	40 to 62 min	51 to 61 min	67 to 83 min

- The above times indicate the amount of time to the end of steaming after cooking is completed when the rice is not soaked prior to pressing the [Start] key. (Voltage: 230-240 V, Room temperature: 23°C, Water temperature: 23°C, Amount of water: normal level)
- Cooking times will differ somewhat depending upon the amount being cooked, the type of rice, the type and quantity of ingredients, the room temperature, the water temperature, the amount of water, electrical voltage, and whether the Timer function is used or not, etc.

5 Once the Rice Is Done Cooking

Once the final steaming process begins, the remaining time will be displayed.

The time until steaming is completed will be shown on the display in 1-minute increments.



• Steaming times will vary depending upon the selected menu.

Once the rice is fully cooked, the Keep Warm function will automatically engage (the Start lamp will turn off).

The Keep Warm lamp will turn on and an alarm (8 beeps) will sound.

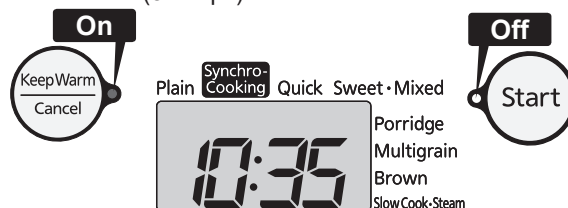

• If you added ingredients under the “Porridge” menu, or a longer cooking time is required, etc., you can set the desired additional cooking time. Simply press the [Hour] and [Min] keys once the Keep Warm lamp turns on, and then press the [Start] key. The cooking time can be extended up to 15 minutes in increments of 1 minute, a maximum of 3 times.
• Stir the rice well before reheating.

6 Setting the Timer

1 Stir and loosen the cooked rice.

Be sure to stir and loosen the rice as soon as cooking is complete.

- Always wear a kitchen mitten, etc., to hold the pot while stirring.

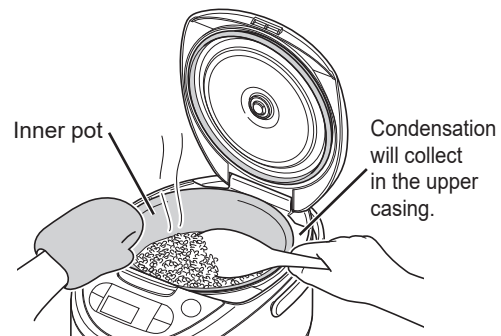

Note

- Be sure to wipe off any hot water that collects on the upper casing or that runs onto the outside of the rice cooker when you open the lid immediately after cooking or while the Keep Warm function is on.

When you are done using the rice cooker...

1 Press the [KeepWarm/Cancel] key to turn off the Keep Warm function.

The Keep Warm lamp will turn off.

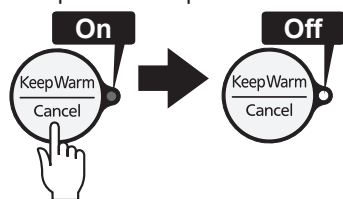

Note

- If you disconnect the power plug without canceling the Keep Warm function, the next time you turn on the rice cooker, the Keep Warm light turns on and you cannot cook.

2 Disconnect the power plug and then the appliance plug.

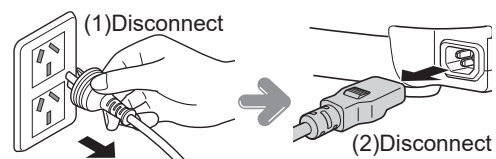

3 Clean the rice cooker. (See p.30 to 35.)

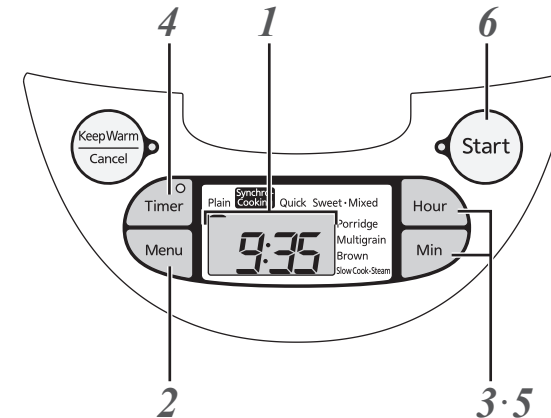

Using the Timer function (Timer 1 / Timer 2)

You can preset the time that you want cooking to be actually completed.

- Select either “Timer 1” or “Timer 2” and set the desired completion time. The start of cooking will be automatically adjusted so that the operation is completed at the preset time.
- Each timer can be set to different times. e.g. “Timer 1” for breakfast and “Timer 2” for dinner.
- The preset timer settings will be stored in memory.



- Example setting: If “Timer 1” is set to 13:30, cooking will be completed at 13:30.

1 Check the present time.

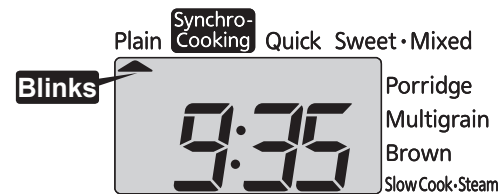

- See p.42 for the procedure to set the present time.

2 Press the [Menu] key to select the desired menu.

The ▲ symbol will blink while the menu is being selected.

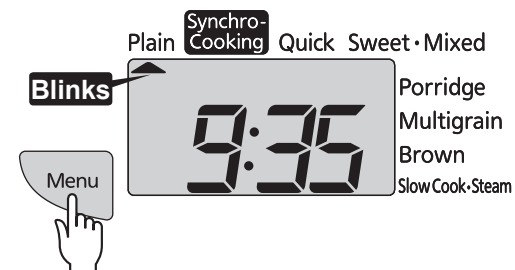

- It is not necessary to press the [Menu] key if the desired menu is already selected.

3 If you selected the “Porridge” menu, use the [Hour] and [Min] keys to set the desired cooking time.

- Each time the [Hour] key is pressed, the set time will increase by 5 minutes. Each time the [Min] key is pressed, that time will decrease by 5 minutes.
- The cooking time can be set to any 5-minute increment between 40 and 90 minutes.

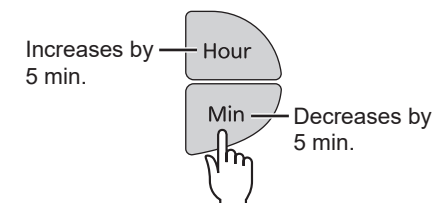

- The default setting is for 60 minutes. Adjust as desired.

4 Press the [Timer] key to select either “Timer 1” or “Timer 2”.

The selected setting will switch back and forth between “Timer 1” and “Timer 2” each time the [Timer] key is pressed.

Both the Timer lamp and the displayed “Timer 1” or “Timer 2” will blink.

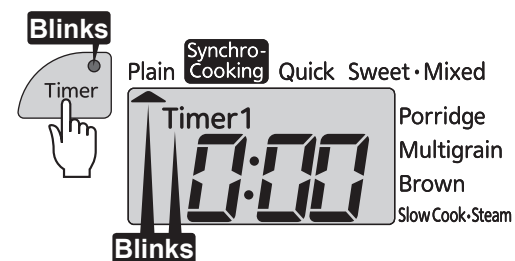

- The previously preset time will be displayed. It is not necessary to set the timer again if the desired completion time is already displayed.

Note

- The Timer function is not available in the following cases.
 - When the “Synchro-Cooking”, “Quick”, “Sweet•Mixed”, “Slow Cook•Steam” menu is selected
 - When the preset time is less than that indicated in the following table
- | Menu | Minimum preset time |
|------------|----------------------|
| Plain | 1 h 10 min |
| Porridge | Cooking time + 2 min |
| Multigrain | 1 h 10 min |
| Brown | 1 h 30 min |
- When “0:00” is blinking on the display
 - If the Keep Warm lamp is on, press the [KeepWarm/Cancel] key to turn off the lamp. (The Timer function is not available while the Keep Warm lamp is on.)
 - If you do not operate the rice cooker within about 30 seconds after pressing the [Timer] key, an alarm (3 beeps) will sound.
 - If the [Timer] or [Start] key is pressed while the rice cooker is in a state where the Timer function is not available, an alarm (3 beeps) will sound.
 - Rice may not be fully cooked by the preset time, depending on factors such as room temperature, water temperature, and supplied voltage.

5 Use the [Hour] and [Min] keys to set the desired completion time.

Press the [Hour] key to change the set time in 1-hour increments. Press the [Min] key to change that time in 10-minute increments. Hold down the corresponding key to change the time more rapidly.

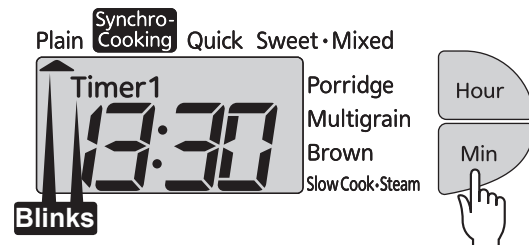

Note

- Do not set the timer to more than 12 hours, as it may result in spoiled rice.

6 Press the [Start] key.

The Timer lamp will turn on and the Timer function is set. If you selected the “Plain” menu, a one-short, one-long beep alarm will sound. Otherwise, only a one-beep alarm will sound.

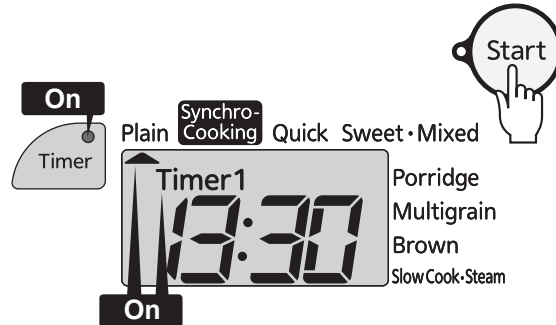

- If you make a mistake or otherwise want to reset the timer, press the [KeepWarm/Cancel] key and repeat the procedure from step 2 on p.19.

The Keep Warm function will automatically engage when cooking is completed.

Turning off the Keep Warm function

Press the [KeepWarm/Cancel] key.

The Keep Warm lamp will turn off.

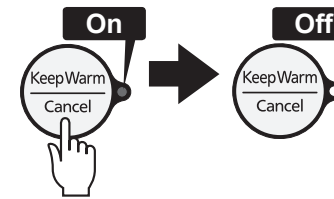

Restarting the Keep Warm function

Confirm that the Keep Warm lamp is off and press the [KeepWarm/Cancel] key.

The Keep Warm lamp will turn on.



Keeping a small amount of rice warm

Gather the rice at the center of the inner pot; serve as soon as possible.

Elapsed Keep Warm time display

Hold down the [Hour] key to display the elapsed Keep Warm time. The elapsed time will be displayed in 1-hour increments up to 24 hours (“24h”). If more than 12 hours has elapsed, the time on the display will blink up to 24 hours.

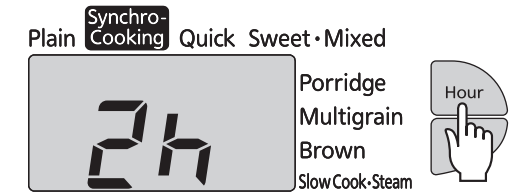

*Once 24 hours has elapsed, “24” will blink on the display.

Note

- Avoid the following, as they may result in unusual odors, dryness, discoloration, and spoiling of the rice, or corrosion of the inner pot.
 - Using the Keep Warm function with cold rice
 - Adding cold rice to rice that is being kept warm
 - Leaving a spatula in the inner pot while the Keep Warm function is on
 - Using the Keep Warm function with the power plug disconnected
 - Using the Keep Warm function for longer than 12 hours
 - Keeping less than the minimum required amount of rice warm
 - 1.0L (5.5-cup) type :1 cup
 - 1.8L (10-cup) type :2 cups
 - Using the Keep Warm function for anything other than white rice (including rinse-free rice)
 - Keeping warm a lump of rice with a hole in the middle.
 - Turning off the Keep Warm function with the rice left in the rice cooker.
- When using the “Porridge” menu, the porridge can become pasty if kept warm for too long; serve as soon as possible.
- Do not leave the cooking plate or food cooked using the cooking plate inside the rice cooker while the Keep Warm function is on.
- Be sure to remove any grains of rice that adhere to the brim of the inner pot as well as to any gaskets. Failure to do so can result in dryness, discoloration, odors, and stickiness of the rice being cooked.
- Serve cooked rice as soon as possible in cold climates and high temperature environments.

8 Reheating Cooked Rice

For piping hot rice, reheat the rice that is being kept warm before serving it.

Note

- Rice will not be fully heated if more than half of the inner pot is full.
- The rice will end up dry if reheated under any of the following conditions.
 - The rice is still hot, such as immediately after cooking.
 - There is less than the minimum required amount of rice (1 cup with the 1.0 L type, 2 cups with the 1.8 L type).
 - The rice is reheated 3 times or more.

1 Stir and loosen the rice that was being kept warm.

2 Add 1 to 2 tablespoons of water evenly over the rice.



- Adding water will prevent the rice from drying out and result in plumper rice.

3 Make sure that the Keep Warm lamp is on.



- Reheating is not available if the Keep Warm lamp is not on. If the lamp is not on, press the [KeepWarm/Cancel] key. (See p.21.)

9 Cooking Rice and Side Dishes Together ("Synchro-Cooking" Menu)

You can use the cooking plate to cook side dishes described in the supplied "COOKBOOK" at the same time as you cook rice. You can also add water to the inner pot and cook side dishes without making rice. Refer to the supplied "COOKBOOK" for directions.

Note

- Do not cook with a greater volume of ingredients than that indicated in the supplied "COOKBOOK". Doing so may cause the contents to boil over or result in improperly cooked food.
- When cooking dishes with a strong odor, the odor may adhere to the cooking plate.
- When cooking ingredients with a strong color, that color may be transferred to the cooking plate through the broth, etc.
- Do not use sharp instruments like kitchen knives, table knives, or forks inside the cooking plate.

Precautions for ingredients to be placed in the cooking plate

- Do not fill up the cooking plate with ingredients.
- Spread or make spaces between ingredients so that steam is applied evenly (fill up to the position shown below).

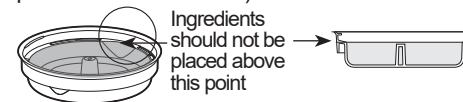

- Only use a small amount of liquid such as water or sauce (it takes time to heat a large amount of liquid).
- If milk or fresh cream is separated during use, stir it well.
- Only use a small amount of leavening ingredients such as pancake mix (about 1/3 of the cooking plate). Be careful about the number of eggs because they increase in volume (2 eggs (medium size) for 1.0L (5.5-cup) type rice cooker, 3 eggs (medium size) for 1.8L (10-cup) type rice cooker can be added. Adjustment may be necessary when you add other ingredients.).
- Cut the root vegetables in thin slices as it takes a long time to cook them.
- Using the cooking plate, only steaming is possible. *If heating is not sufficient while cooking by following the above suggestions, transfer the ingredients to another container, and reheat them using a device such as a microwave (do not put the inner pot and cooking plate in the microwave).

4 Press the [Start] key.

The Start lamp will blink and reheating will start. The remaining time will be displayed and an alarm (3 long beeps) will sound when the operation is completed.

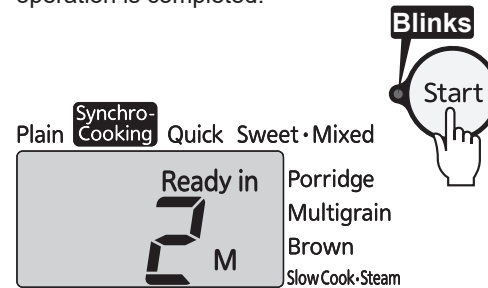

- To stop reheating, press the [Keep Warm/Cancel] key.
- Reheating is not available if the rice is too cold (under about 55°C). In this case, a repeated beeping alarm will sound.

5 Stir and loosen the reheated rice well, and even it out in the inner pot.

- Always wear a kitchen mitten, etc., to hold the pot while stirring.

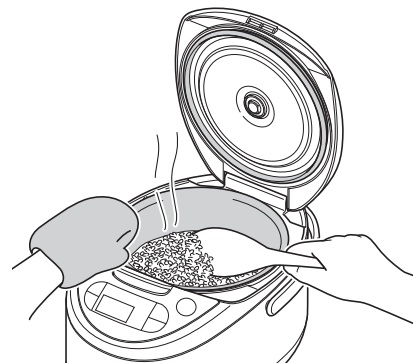

1 Prepare the ingredients and place them in the cooking plate.

- Stacking ingredients on top of each other may result in the contents boiling over or in improperly cooked food. Spread ingredients over the whole of the cooking plate.

2 Make the necessary preparations for cooking rice. (See p.14.)

Note

- Refer to the following table for the acceptable amounts of rice that can be cooked concurrently with food. Do not cook more than the acceptable maximum or less than the minimum required amounts. Doing so may cause the contents to boil over or result in improperly cooked food.

1.0 L type		1.8 L type	
Maximum	Minimum	Maximum	Minimum
2 cups	1 cup	4 cups	2 cups

3 Place the cooking plate inside the inner pot and close the lid.

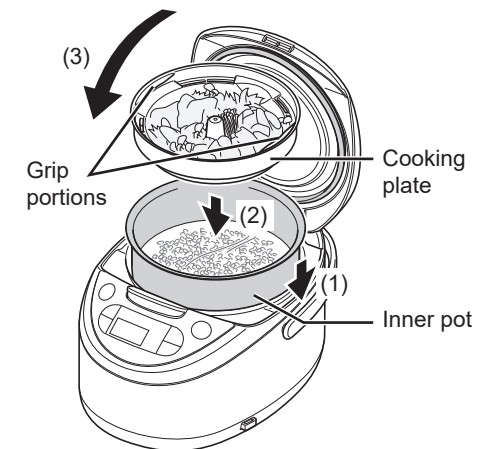

Note

- Always place the cooking plate inside the inner pot.
- Make sure that the cooking plate is level (not set at an angle).

10 Slow Cooking (“Slow Cook•Steam” Menu)

4 Connect each end of the power cord to the specified locations.

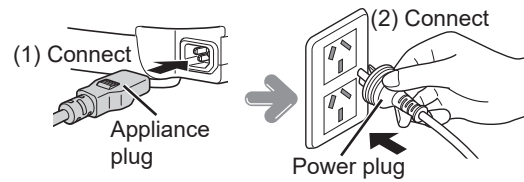

Note

- If the Keep Warm lamp is on, press the [KeepWarm/Cancel] key to turn off the lamp.

5 Use the [Menu] key to select the “Synchro-Cooking” menu.

The ▲ symbol will blink while the menu is being selected.

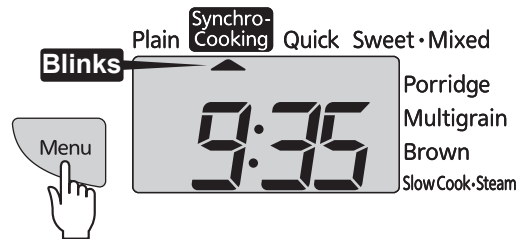

Always select the “Synchro-Cooking” menu when cooking concurrently.

6 Press the [Start] key.

The Start lamp will turn on and concurrent cooking will start.



Note

- Do not open the lid during steaming. Doing so may prevent the food from steaming properly.

7 Once cooking is completed, an alarm (8 beeps) will sound (the Start lamp will turn off).

The Keep Warm lamp will turn on.



8 Remove the cooking plate and stir and loosen the rice.

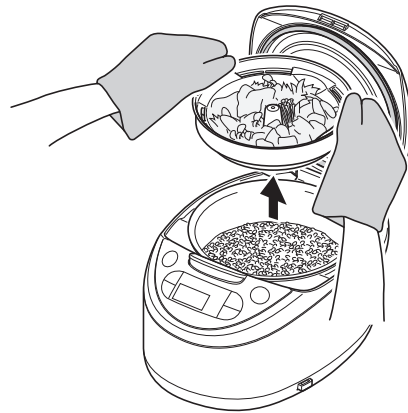

Note

- Do not leave the cooking plate in the rice cooker while the Keep Warm function is on.
- Be careful when removing the cooking plate after cooking, as it will be hot.
- Do not tilt the cooking plate while removing it. The broth, etc., may spill out and result in burns.
- Do not return the cooking plate to the inner pot after removing it. Doing so may result in the rice spoiling or not being kept warm.
- When cooking with ingredients that release a lot of liquid, oils or fats when heated, or that expand during heating, such as eggs and the like, some of the broth may overflow down into the rice.

Cooking without making rice

Cooking can be performed with water added to the inner pot.

See “Steaming Food (“Slow Cook•Steam” Menu)” (p.27 to 29).

Note

- Add water up to the appropriate line (line 1 for 1.0 L [5.5-cup] type, line 2 for 1.8 L [10-cup] type) on the “Plain” scale on the inside of the inner pot.
- Set the cooking time to between 20 and 30 minutes, according to the type of food being cooked.

You can prepare the following dishes with ease. Refer to the supplied “COOKBOOK” for directions.

With this menu, food is first brought to near boiling, the heat is then lowered to about 93°C and the food left to simmer. The temperature is then lowered even further to about 88°C and simmering is continued. By gradually lowering the heating temperature in this way, flavors are enhanced and the liquids do not boil down even when heated for a long period of time.

Menu examples

Braised pork, gobo and yamaimo soup



- For how to cook “braised pork” and “gobo and yamaimo soup”, see the supplied “COOKBOOK”.

Note

- Caution should be exercised when making dishes other than those described in the supplied “COOKBOOK”, as they may boil over.
- Stir well before cooking to prevent seasonings from settling at the bottom of the inner pot.

1 Prepare the ingredients.

2 Add ingredients to the inner pot and close the lid.

Note

- Use the “Plain” scale on the inside of the inner pot as a reference. Using more than the maximum acceptable amount (see the table below) can prevent proper boiling or cause the contents to boil over. Be careful also not to use less than the minimum required amount either, as that can also cause the contents to boil over.

“Plain” scale			
1.0 L type		1.8 L type	
Maximum	Minimum	Maximum	Minimum
5.5 or below	2 or above	8 or below	3 or above

3 Connect each end of the power cord to the specified locations.

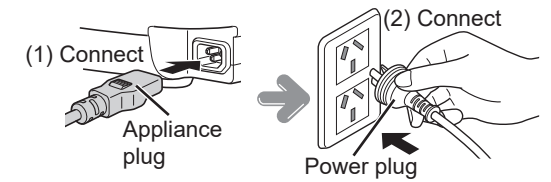

Note

- If the Keep Warm lamp is on, press the [KeepWarm/Cancel] key to turn off the lamp.

4 Use the [Menu] key to select the “Slow Cook•Steam” menu.

The ▲ symbol will blink while the menu is being selected.

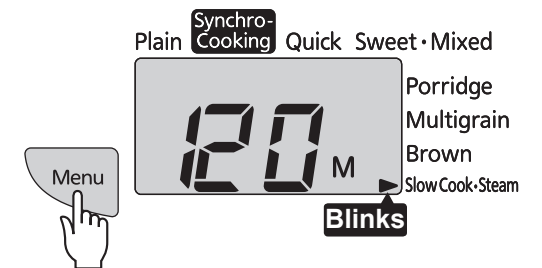

5 Use the [Hour] and [Min] keys to set the desired cooking time.

Each time the [Hour] key is pressed, the set time will increase by 5 minutes. Each time the [Min] key is pressed, that time will decrease by 5 minutes.

The cooking time can be set to any 5-minute increment between 5 and 180 minutes.

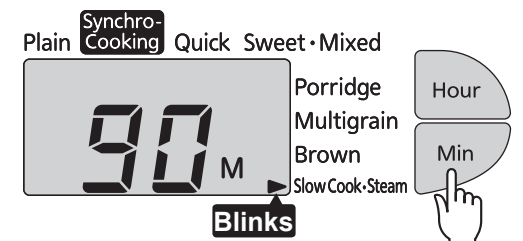

- 6 Press the [Start] key.**
The Start lamp will turn on and steaming will start.
“Ready in” will appear on the display.

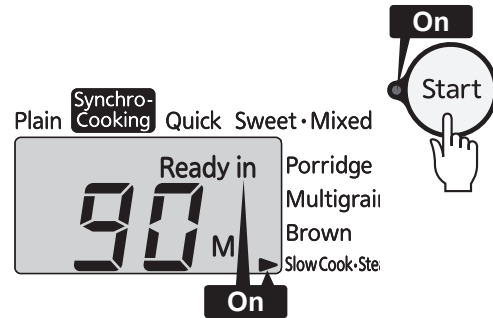

Note

- Do not open the lid during steaming. Doing so may prevent the food from steaming properly.

- 7 Once cooking is completed, an alarm (8 beeps) will sound (the Start lamp will turn off).**

The Keep Warm lamp will turn on and “0h” will be displayed.

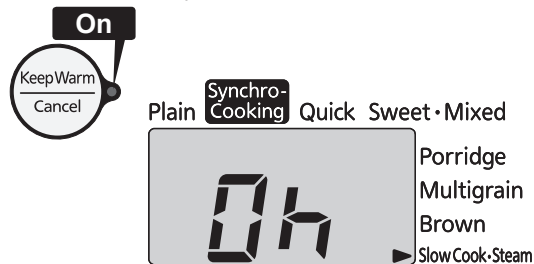

- If a longer cooking time is required, you can set the desired additional cooking time. Press the [Hour] and [Min] keys to set the additional cooking time with the Keep Warm lamp turn on. The cooking time can be extended up to 30 minutes, a maximum of 3 times.

Note

- If a longer cooking time is required, do not press the [Keep Warm/Cancel] key before extending that time. Doing so will cause the Keep Warm lamp to go out and additional cooking will not be possible. If you mistakenly pressed the [KeepWarm/Cancel] key, perform the following procedure.
 - Remove the inner pot and set it on a wet towel or cloth.
 - Leave the rice cooker lid open and cool down the unit and the inner pot for about 10 minutes.

- Place the inner pot back inside the rice cooker.
- Repeat the procedure from step 4 on p.25.

Once cooking is completed...

- 1 Press the [Keep Warm/Cancel] key to turn off the Keep Warm function.**
The Keep Warm lamp will turn off.

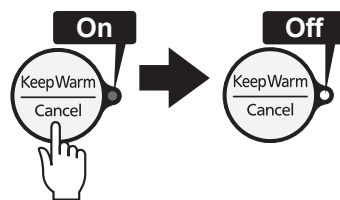

- 2 Disconnect the power plug and then the appliance plug.**

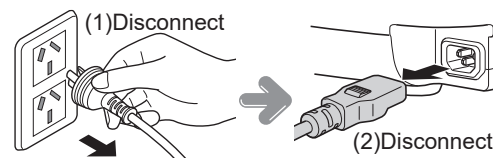

- 3 Remove any odors. (See p.35)**

Note

- If the [Keep Warm/Cancel] key is not pressed when cooking is completed, the Keep Warm function will automatically engage and the elapsed Keep Warm time will be displayed in hourly increments from the first hour (“1h”) up to 6 hours (“6h”) after that. After 6 hours has elapsed, “6” will blink on the display.
- Do not use the Keep Warm function continuously for more than 6 hours as some foods will lose their taste.

- 1 Add water to the inner pot and place the cooking plate inside.**

Refer to the following guideline on the amount of water to add.

- 1.0 L (5.5-cup) type: 3-1/2 cups (630 mL)
- 1.8 L (10-cup) type: 4-1/2 cups (810 mL)

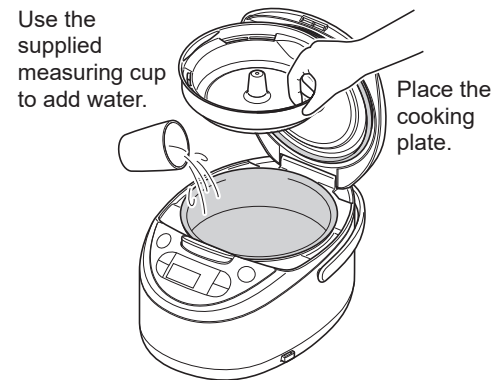

Note

- Be sure to put an appropriate amount of water in the inner pot. Do not allow the inner pot to run out of water or the cooking plate to become immersed in water during steaming.

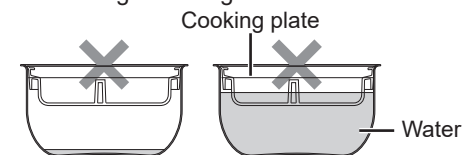

- 2 Add ingredients to the cooking plate and close the lid.**

- 3 Connect each end of the power cord to the specified locations.**

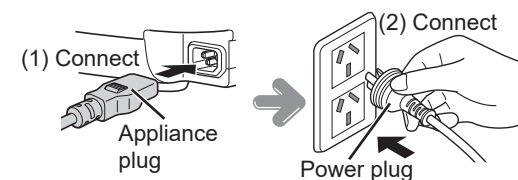

Note

- If the Keep Warm lamp is on, press the [KeepWarm/Cancel] key to turn off the lamp.

- 4 Press the [Menu] key to select the “Slow Cook·Steam” menu.**

The ▲ symbol will blink while the menu is being selected.

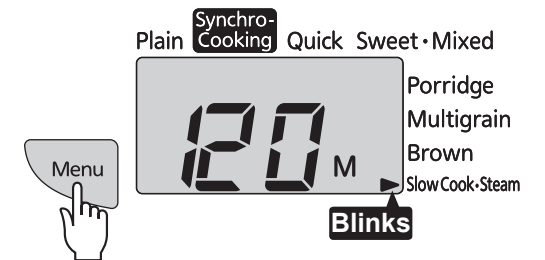

- 5 Press the [Hour] and [Min] keys to set the desired steaming time.**

Each time the [Hour] key is pressed, the set time will increase by 5 minutes. Each time the [Min] key is pressed, that time will decrease by 5 minutes.

Set the steaming time between 5 and 60 minutes.

* Do not set the time to more than 60 minutes.

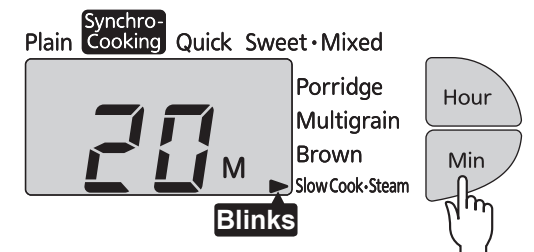

- 6 Press the [Start] key.**

The Start lamp will turn on and steaming will start.

“Ready in” will appear on the display.

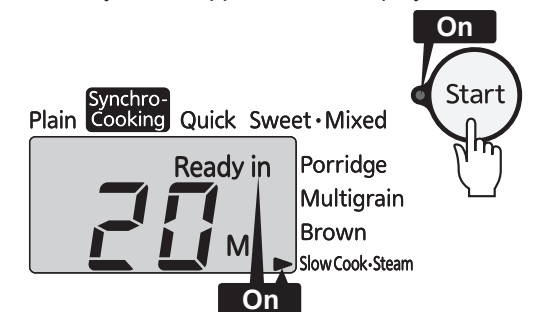

Note

- Do not open the lid during steaming. Doing so may prevent the food from steaming properly.

7 Once steaming is completed, an alarm (8 beeps) will sound (the Start lamp will turn off).

The Keep Warm lamp will turn on and "0h" will be displayed.



- To steam the food further, use the [Hour] and [Min] keys to set the additional steaming time and then press the [Start] key. The steaming time can be extended up to 30 minutes, a maximum of 3 times.

Caution

- Be careful not to get burned by the escaping steam when opening the lid.

Note

- When extending the steaming time, be sure to add water to prevent dry-boiling.
- If a longer steaming time is required, do not press the [Keep Warm/Cancel] key before extending that time. Doing so will cause the Keep Warm lamp to go out and additional steaming will not be possible. If you mistakenly pressed the [KeepWarm/Cancel] key, perform the following procedure.
 - Remove the inner pot and set it on a wet towel or cloth.
For the amount of water, see step 1 on p.27.
 - Leave the rice cooker lid open and cool down the unit and the inner pot for about 10 minutes.
 - Place the inner pot back inside the rice cooker.
 - Repeat the procedure from step 4 on p.27.

8 Remove the cooking plate.

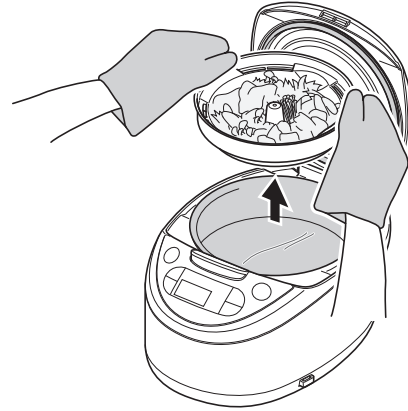

- Be careful when removing the cooking plate after cooking, as it will be hot.
- Serve as soon as steaming is completed. If not removed from the rice cooker right away, the food will become wet and soggy.
- Do not tilt the cooking plate while removing it. The broth, etc., may spill out and result in burns.

Once steaming is completed...

- Press the [KeepWarm/Cancel] key to turn off the Keep Warm function.
The Keep Warm lamp will turn off.

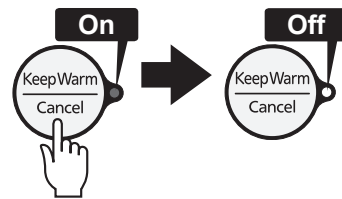

- Disconnect the power plug and then the appliance plug.

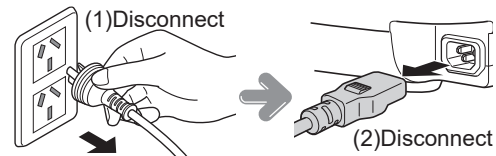

- Clean the rice cooker. (See p.30 to 35.)

Guidelines for steaming times

Ingredients	Amount	Approx. time	Hints for steaming
Chicken	1 fillet (200 to 300 g)	20 to 30 min	Make several small cuts in the chicken.
White fish	2 to 3 fillets (150 to 200 g)	20 to 25 min	Fillet to a thickness of 2 cm or less. Always wrap in aluminum foil.
Shrimp	6 to 10 (100 to 200 g)	15 to 20 min	Steam in shells.
Carrots	1 to 2 (200 to 300 g)	30 to 40 min	Cut into bite-sized pieces.
Potatoes	Medium size, 2 to 3 (250 to 300 g)	30 to 40 min	Cut into bite-sized pieces.
Sweet potatoes	Medium size, 1 (200 to 300 g)	30 to 40 min	Cut into bite-sized pieces.
Meat dumplings (warming)	8 to 15	20 to 25 min	Space evenly in cooking plate.

- Do not fill the cooking plate for the 1.0 L (5.5-cup) type any higher than 3 cm, or 4 cm, with the 1.8 L (10-cup) type. Doing so may result in the food touching the lid and becoming wet and soggy.
- Do not allow the hole of the pressure control cap to be blocked with ingredients.
- The steaming times above are only a guideline and the required time will differ depending upon the temperature, quality, and quantity of the ingredients.
- If steaming is still not complete, you can steam for an additional period of time based on how well the food is cooked.
- Normally, there will not be enough water for additional steaming. Add water to prevent the inner pot from running dry.
- If you steam meat and fish, etc., for too long, they will become hard. If food does not steam sufficiently at shorter times, cut into thinner slices.
- Always wrap fish, etc., in aluminum foil for steaming. Failure to do so may result in the contents of the cooking plate boiling over.

12 Cleaning and Maintenance

Any other servicing should be performed by an authorized service representative.

Perform cleaning and maintenance procedures as described on the following p.30 to 35.

Clean all parts by hand. Do not use a dishwasher/dryer.

To maintain cleanliness, always clean the rice cooker on the same day it is used. Also clean the rice cooker at regular intervals as well.

The rice cooker should also be cleaned on the day that it is used in order to remove any odors that remain from cooking. (See p.35.)

Note

- Be sure to disconnect the power plug and allow the rice cooker, inner pot, inner lid, and steam cap to cool down before cleaning.
- Clean with a soft sponge and cloth.
- When cleaning the rice cooker with a detergent, use only standard kitchen detergent (for tableware and kitchen utensils).
- Rinse the parts thoroughly since detergent remaining on them may result in deterioration and discoloration of part's materials such as resin.

Parts to wash after every use

1 Clean with a soft sponge and with tap or lukewarm water.

2 Wipe off water with a dry cloth and completely dry all parts.

Note

- Do not clean the inner pot with the abrasive side of a heavy-duty scrub sponge. Doing so may damage the fluorocarbon resin coating.

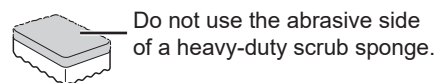

- Do not wash dishes, etc., inside the inner pot. Also, do not place the inner pot upside down on top of dishes, etc., to dry. Doing so may damage the fluorocarbon resin coating or cause it to peel.

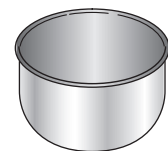
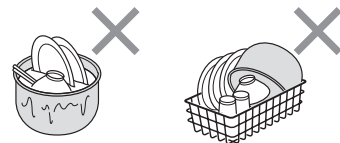

Inner pot

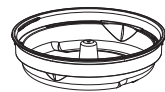

Cooking plate



Measuring cup



Spatula



Ladle



Steam cap
(See p.33 to 34.)

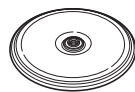

Inner lid

Parts to wash when dirty

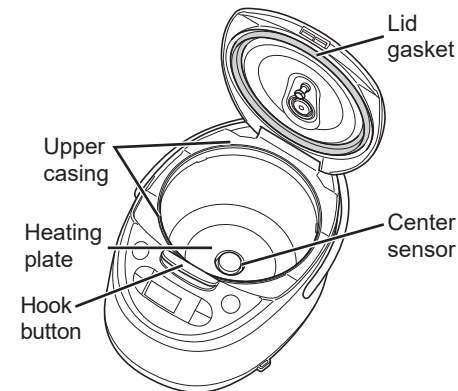

Inside and outside the rice cooker

Wet a towel or cloth, wring out excess water, and wipe.

Center sensor

Remove burned rice and any other adhering grains of rice. If adhering objects are hard to remove, use commercially available sandpaper (around #320), then wet a towel or cloth, wring out excess water, and wipe.

Around the upper casing and hook button and on the lid gasket

Remove any adhering grains of rice, etc.

Note

- Do not allow water to get inside the rice cooker unit.
- Do not immerse the power cord in or splash it with water. Doing so may result in short-circuiting or electric shock.

Power cord and plug

Wipe with a dry cloth.



Note

- Do not pull on the lid gasket.
- Always keep the inner pot and lid clean to prevent corrosion and odors.
- Do not clean the rice cooker or its parts with thinner, cleanser, bleach, disposable cloth, metal spatulas, nylon scouring sponges or the like.
- Always clean each part separately.
- Do not immerse the steam cap, measuring cup or spatula in hot water. Doing so may cause them to become deformed.
- Do not use a dishwasher/dryer to clean the rice cooker or its parts. Doing so may cause them to become deformed.
- When cleaning the rice cooker with a detergent, do not use alkaline kitchen detergent.
- Always clean the lid or pressure control cap after cooking rice with cereal grains. Otherwise the pressure control cap may be clogged causing a problem that the pressure control cap does not open or rice cannot be cooked well.

Removing and attaching the inner lid

Pull the inner lid towards you to remove it.
To reattach, align the inner lid gasket with the shaft on the main lid.

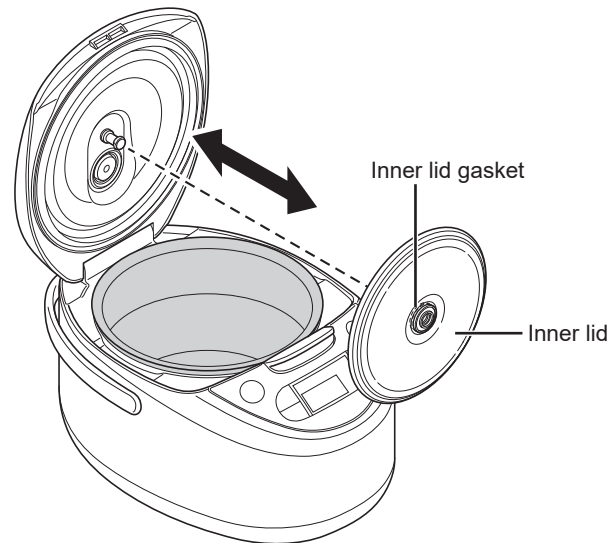

When attaching the inner lid, set it on the main lid by pressing the center of the inner lid without applying excessive force.
Applying excessive force or pressing the edge of the inner lid may cause the inner lid to become deformed.

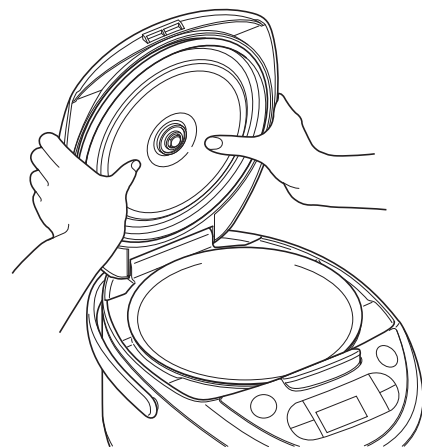

■ Attaching the inner lid gasket

If the inner lid gasket is loose, press it firmly back into place.

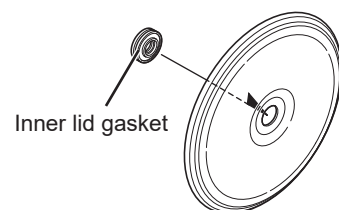

Removing and attaching the steam cap

■ Removing the steam cap

- 1 Insert your finger into the hole in the lid and lift the steam cap upwards.

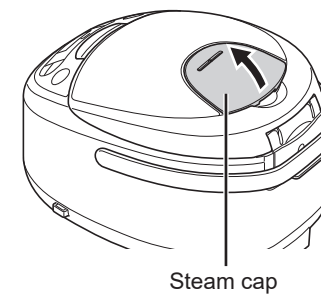

- 2 Turn the inside portion of the assembly as shown in the illustration to loosen it.

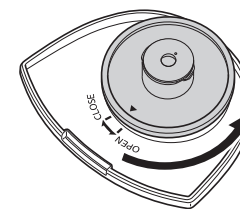

- 3 Lift up on the inside portion to separate it from the cap.

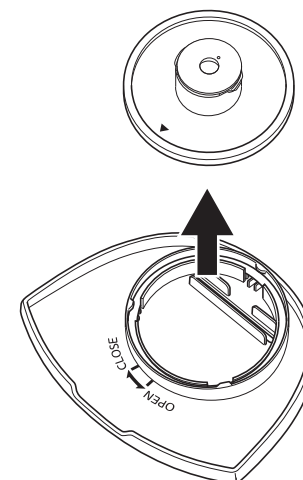

■ Attaching the steam cap

- 1 Set the inside portion of the assembly on top of the cap portion.

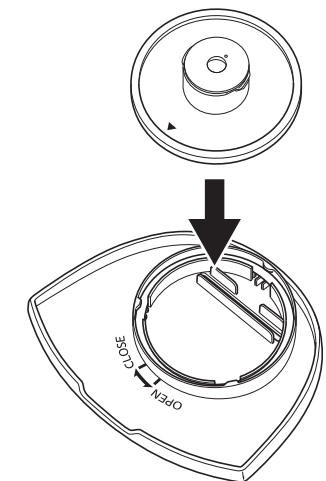

- 2 Turn the inside portion of the assembly as shown in the illustration to tighten it.

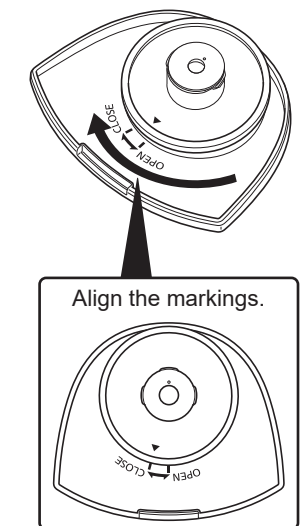

- 3 Attach the steam cap back in the lid.

■ Installing the steam cap gaskets

If the gaskets are loose, refer to the illustration and set them securely into place. If the gaskets are not set securely, they can become loose and may result in problems due to steam leaking out, etc.

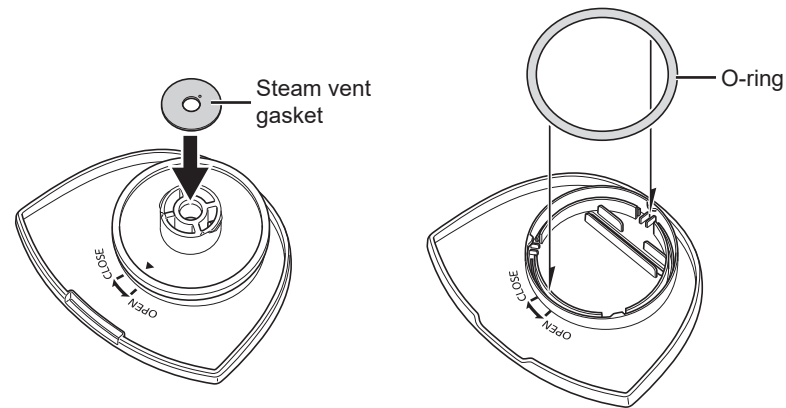

Cleaning the lower heating plate

Water drops may fall from the inner lid during cooking and cause the surface of the lower heating plate to become dirty. This will not affect the performance of the rice cooker but, if you would like, you can clean the heating plate using the following procedure.

- 1 Add a bit of standard kitchen cream cleanser to a nylon scouring sponge, and remove the surface dirt.
- 2 Wipe clean with a damp paper towel or cloth.

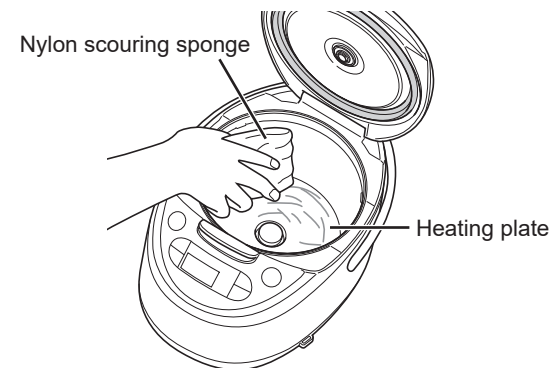

Removing odors (When odors remain in the rice cooker and/or cooking plate)

The following procedure should be performed each time after cooking, or if odors become bothersome.

Note

- Be careful of the hot inner pot, cooking plate, and rice cooker after cleaning. Touching them may result in burns.

■ Rice cooker

Do not place the cooking plate inside the inner pot.

- 1 Fill the inner pot to about 70 to 80% with water, select the "Plain" menu and press the [Start] key.
Confirm that the Keep Warm lamp is on and press the [KeepWarm/Cancel] key.

Note

- If odors become bothersome, use about 20g of citric acid added to the water for more effective deodorizing. It may be impossible to remove some odors completely. In this case, contact the place of purchase.

- 2 Wash the inner pot and steam cap with a standard kitchen detergent, and then rinse sufficiently with water.
- 3 Allow the rice cooker and all parts to dry in a well-ventilated location.

■ Cooking plate

Immerse the cooking plate in hot water and allow it to soak for about 1 hour.

13 If Rice Does Not Cook Properly

Check the following points if you experience a problem with the cooked rice or with the operation of the rice cooker, etc.

Check point		Was the amount of rice, ingredients, and water, or the ratio of multi-grain rice, correct?	Was cooking done with acceptable amount cooked?	Was cooking done with alkaline ionized water (pH 9 or higher)?	Was cooking done with hard water like mineral water?	Was the correct menu selected?	Was the Timer function used?	Was the [Start] key pressed after cooking without turning off the Keep Warm function?	Are there grains of burned rice or water drops adhering to the outside bottom of the inner pot, or to the heating plate or the center sensor?	Is the inner pot deformed?	Was the rice stirred and loosened well?	Was there a prolonged power outage?
Problem	Is too hard	●	●		●	●			●	●	●	●
	Is too soft	●		●		●	●	●	●	●	●	●
	Is not cooked completely	●	●			●		●	●	●	●	●
	Has a hard center	●	●			●		●	●	●	●	●
	Is burned	●		●		●	●	●	●	●	●	●
During cooking	Steam leaks	●	●					●	●			
	Boils over	●	●			●		●				
	The cooking time is excessively long	●	●			●		●	●			●
Reference page		12-14, 43	43	-	-	16	-	18	14, 30-31	-	18	43

Check point		Are there any grains of rice adhering to gaskets or the brim of the inner pot, etc.?	Was the rice (other than rinse-free rice) washed sufficiently?	Was hot water (35°C or higher) used to wash the rice or adjust the water level?	Was the rice left soaking in the water too long after washing?	Was the rice left in a colander after washing?	Was the lid closed securely?	Was the rice mixed with other ingredients or multi-grain rice? Were seasonings stirred well?	Were there a lot of cracked grains of rice?	Was cooking continued immediately after the initial cooking?	Was the rice cooker and its parts cleaned sufficiently?
Problem	Is too hard			●			●	●	●	●	●
	Is too soft			●	●	●	●	●	●	●	
	Is not cooked completely			●				●	●	●	
	Has a hard center			●				●	●	●	
	Is burned		●	●	●			●			●
During cooking	Smells like rice bran		●								
	Steam leaks	●					●				●
	Boils over	●	●					●			●
The cooking time is excessively long	●										
Reference page		14, 30-31	12, 14	14	-	-	15, 30-34	12	-	-	30-35

Problem	Cause
There is a thin film covering the rice.	A thin, tissue-like film is formed by melted and dried starch. This is not harmful to your health.
Rice sticks to the inner pot.	Soft rice and sticky rice can easily stick to the pot.

Check point		Was the amount of rice and water correct?	Are there grains of burned rice or water drops adhering to the outside bottom of the inner pot, or to the heating plate or the center sensor?	Was the rice stirred and loosened well?	Are there any grains of rice adhering to gaskets, the brim of the inner pot, or the lid, etc.?	Was the rice (other than rinse-free rice) washed sufficiently?	Was the rice or food reheated 3 or more times?	Was the Timer function set for more than 12 hours in advance?	Was the Keep Warm function used continuously for more than 12 hours?	Was the rice left in the rice cooker with the Keep Warm function turned off?	Was there a prolonged power outage?
Problem	Has an odor		●		●	●		●	●	●	●
	Is discolored		●	●	●			●	●		
	Is dry	●	●	●	●				●		
	Is sticky	●	●	●	●			●	●	●	●
	Reheated rice is dry	●	●				●				
Reference page		12-14, 43	14, 30-35	18	14, 30-31	12, 14	22	20	21	-	43

Check point		Is other than white rice or rinse-free rice being kept warm?	Was less than the minimum required amount of rice being kept warm or reheated?	Is the rice concentrated around the outer portions of the inner pot (less rice in the middle of the pot)?	Was cold rice added?	Was a spatula left in the inner pot?	Was the rice cooker and its parts cleaned sufficiently?	Did you try to reheat rice that was just cooked and was still hot?	Were odors removed after cooking?
Problem	Has an odor	●	●		●	●	●		●
	Is discolored	●	●	●	●	●			
	Is dry	●	●	●	●	●			
	Is sticky	●	●		●	●			
Reheated rice is dry			●					●	
Reference page		21	21	21	21	21	30-35	22	26, 35

14 If Synchro-Cooking Does Not Go As Expected

Check the following points when you experience a problem with food cooked concurrently using the cooking plate.

Check point		Were more ingredients and seasonings used than indicated in the "COOKBOOK"?	Were the ingredients arranged unevenly in the cooking plate?	Were more than the acceptable maximum or less than the minimum required amounts used?	Was a menu other than "Synchro-Cooking" used?	Was the food cooked according to precautions for ingredients to be placed in the cooking plate?	Was there a power outage during cooking?
Problem	Is too hard	●		●	●	●	●
	Is too soft	●		●	●	●	●
Cooked rice	Is not cooked completely			●	●	●	●
	Has a hard center			●	●	●	●
	Is burned	●	●	●	●	●	●
	Has an odor	●	●	●	●	●	
	Is sticky	●	●	●	●	●	
Cooked food	Is too hard	●	●	●	●	●	
	Is too soft	●	●	●	●	●	
	Is not fully heated	●	●	●	●	●	●
During cooking	Overflows into the rice	●	●	●		●	
	Steam leaks	●	●	●	●	●	
	Boils over	●	●	●	●	●	
	The cooking time is excessively long	●		●	●	●	●
Reference page		23	23	23	24	23	43

15 If Slow Cooking Does Not Go As Expected

Check the following points if you experience a problem with the cooked.

Check point		Were the appropriate ingredients and amounts used?	Were more than the maximum acceptable ingredients added?	Were less than the minimum required ingredients added?	Was the cooking time too short?	Was the cooking time too long?	Are there any grains of burned rice or any other remaining grains of rice adhering to gaskets or the brim of the inner pot, etc.?	Was the lid closed securely?	Was there a power outage during cooking?
Problem	Does not boil	●	●		●		●	●	●
	Boils over	●	●	●					
	Boils down	●		●		●			
Reference page		25			25		14, 30-31	15, 30-34	43

16 Troubleshooting

Check the following before requesting repair service.

Symptom	Check point	Action	Reference page
The rice or other foods are not cooked at all.	Is the power plug properly connected to an outlet?	Insert the power plug fully into an outlet.	15
Rice was not cooked completely by the preset time.	Does the display show the correct present time?	Set the correct present time.	42
	Check "The cooking time is excessively long" under "If Rice Does Not Cook Properly" and take the necessary action.		36
The Timer function cannot be set.	Does the display show the correct present time?	Set the correct present time.	42
	Is "0:00" blinking on the display?	Set the present time.	
	Was the "Synchro-Cooking", "Quick", "Sweet•Mixed", or "Slow Cook•Steam" menu selected?	The Timer function is not available under those menus.	19
	Was an unacceptable time set?	Set a time that is acceptable under the Timer function.	
The display is blurred.	Are there any grains of burned rice or any other remaining grains of rice adhering to gaskets or the brim of the inner pot?	Completely remove all remaining rice.	14, 30-35
	Is the outer surface of the inner pot wet?	Wipe with a dry cloth.	
Reheating is disabled.	An alarm (3 beeps) will sound if you press the [Start] key.	The rice is cold. Rice of below approximately 55°C cannot be reheated.	20
	Is the Keep Warm lamp off?	Press the [KeepWarm/Cancel] key and check that the Keep Warm lamp lights up. Then, press the [Start] key again.	22
Sounds can be heard during cooking, reheating, steaming, or while the Keep Warm function is on.	Do you hear a clicking sound?	That is the sound of the microcomputer controller. It is not a malfunction.	10
	Do you hear a sound like scraping metal?	This is the sound of metal contracting and rubbing together due to heat. It is not a malfunction.	
	Do you hear a sound like boiling water? (Only during cooking or steaming)	It is not a malfunction.	10
	Do you hear a completely different sound from the above?	Contact the place of purchase.	-
An alarm (3 beeps) sounds when the Timer function is set.	An alarm will sound if you do not operate the rice cooker within about 30 seconds after pressing the [Timer] key. Continue setting the Timer function.		19
Water or rice has gotten inside the rice cooker unit.	Water or rice inside the rice cooker unit may cause problems. Contact the place of purchase.		-
When setting the present time, pressing the [Hour] or [Min] key does not access the time setting mode.	The time cannot be set during cooking, when the Keep Warm function is on, when the Timer function is in use, or during reheating.		42
The elapsed Keep Warm time blinks on the display when the [Hour] key is pressed while the Keep Warm function is on.	Was the Keep Warm function used continuously for more than 12 hours?	The elapsed Keep Warm time will blink on the display when the Keep Warm function has been on for more than 12 hours.	21
	Was the Keep Warm function used continuously for more than 6 hours under the "Slow Cook•Steam" menu?	The elapsed Keep Warm time will blink on the display when the Keep Warm function has been on for more than 6 hours.	26
The present time, preset timer settings, and elapsed Keep Warm time are lost when the power plug is disconnected.	Does "0:00" blink on the display when the power plug is connected again?	The lithium battery has run out. Contact the place of purchase.	10

Symptom	Check point	Action	Reference page
Nothing happens when a key is pressed.	Is the power plug properly connected to an outlet?	Insert the power plug fully into an outlet.	15
	Is the Keep Warm lamp on?	Press the [KeepWarm/Cancel] key to turn off the Keep Warm function, then try the operation again.	15
The lid will not close, or it opens during cooking.	Are there any grains of rice adhering to the upper casing, lid gasket, or around the hook button?	Completely remove all remaining rice.	14, 31-34
There is a smell of plastic.	Such smells may occur when the rice cooker is first used, but they should go away over time as the rice cooker gets used.		-
There are stripes or waves on plastic parts.	Such stripes and waves are produced when the resin is being molded. They do not affect the performance of the rice cooker.		-
Food adheres to the inner lid during concurrent cooking.	When cooking with ingredients that expand during heating, such as eggs and the like, some of that may adhere to the inner lid. If it is bothersome, reduce the amount of the ingredients.		23

If these indications appear

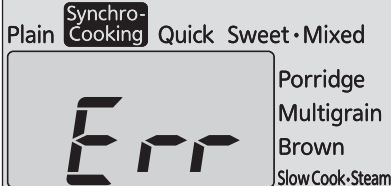
Display	Action	Reference page
<p>"Err" appears on the display and a long-lasting or continuous beeping alarm sounds.</p> 	If the rice cooker still does not respond, there is problem with the unit itself. Disconnect the power plug and contact the place of purchase.	-

Plastic parts

Plastic parts that come into contact with heat or steam will deteriorate over time. In this case, contact the place of purchase.

Setting the present time

The present time is displayed in a 24-hour format.
The time cannot be set during cooking, when the Keep Warm function is on, or when the Timer function is in use or during reheating.

■ Example: Changing the present time from “9:30” to “9:35”

1 Connect each end of the power cord to the specified locations.

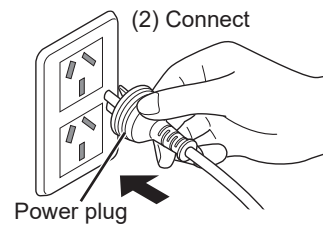
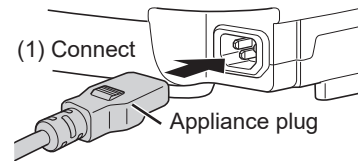

2 Display the time setting mode.

Press the [Hour] or [Min] key to display ☉.

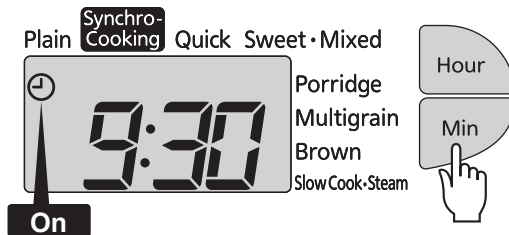

3 Set the present time.

Set the hour with the [Hour] key and the minute with the [Min] key. Hold down the corresponding key to change the time more rapidly.



4 Once you are finished setting the time, press the [Menu] key.

The present time is set.
☉ will go out and “:” will blink on the display.

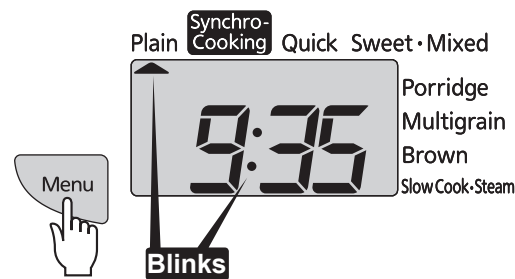

- To cancel setting the time, press the [KeepWarm/Cancel] key.

Specifications

Model	JAX-S10A	JAX-R18A	JAX-S18A		
Unit size	1.0 L (5.5-cup) type	1.8 L (10-cup) type	1.8 L (10-cup) type		
Power source	230 - 240 V 50 - 60 Hz				
Rated power (W)	588 - 641	843 - 918	843 - 918		
Cooking capacity (L)	Plain	0.18 to 1.0 (1 to 5.5 cups)	0.36 to 1.8 (2 to 10 cups)	0.36 to 1.8 (2 to 10 cups)	
	Synchro-Cooking	0.18 to 0.36 (1 to 2 cups)	0.36 to 0.72 (2 to 4 cups)	0.36 to 0.72 (2 to 4 cups)	
	Quick	0.18 to 1.0 (1 to 5.5 cups)	0.36 to 1.8 (2 to 10 cups)	0.36 to 1.8 (2 to 10 cups)	
	Sweet	0.18 to 0.54 (1 to 3 cups)	0.36 to 0.90 (2 to 5 cups)	0.36 to 0.90 (2 to 5 cups)	
	Mixed	0.18 to 0.54 (1 to 3 cups)	0.36 to 1.08 (2 to 6 cups)	0.36 to 1.08 (2 to 6 cups)	
	Porridge	hard	0.09 to 0.18 (0.5 to 1 cup)	0.09 to 0.36 (0.5 to 2 cups)	0.09 to 0.36 (0.5 to 2 cups)
		soft	0.09 (0.5 cup)	0.09 to 0.27 (0.5 to 1.5 cups)	0.09 to 0.27 (0.5 to 1.5 cups)
	Multigrain	0.18 to 0.72 (1 to 4 cups)	0.36 to 1.44 (2 to 8 cups)	0.36 to 1.44 (2 to 8 cups)	
Brown	0.18 to 0.63 (1 to 3.5 cups)	0.36 to 1.08 (2 to 6 cups)	0.36 to 1.08 (2 to 6 cups)		
Outside dimensions (cm)	Width	25.6	28.1	28.1	
	Depth	34.6	37.2	37.2	
	Height	20.8	24.5	24.5	
Weight (kg)	2.9	3.8	3.8		

Note

- One level cup of white rice is about 150 g

In case of a power outage

If a power outage does occur, the rice cooker will resume its normal functions once power is restored.

State when power outage occurs	Once power is restored
While the Timer function is set	The timer will resume operation. (If the power outage lasts for an extended period of time and the preset time has passed when power is restored, the rice cooker will immediately begin cooking.)
During cooking (reheating)	The rice cooker will resume cooking (reheating). Cooking may not be completed properly.
While the Keep Warm function is on	The Keep Warm function will be used continuously.

Purchasing consumables and optional accessories

Gaskets will need replacing over time. Though the amount of wear will vary according to conditions of use, gaskets will wear down as they are used. For stubborn dirt, odors, or serious damage, contact the place of purchase.

The inner pot's fluorocarbon resin coating may wear and peel with extended use. (See p.8.)



TIGER CORPORATION

Head Office: 3-1 Hayami-cho, Kadoma City, Osaka 571-8571, Japan