



SetPower

FC15/20

User Manual

V1.0

CONTENT

1.SAFETY INSTRUCTIONS	01
2.DATA SHEET	04
3.OVERVIEW	04
4.POWER SOURCE INSTRUCTIONS	05
5.OPERATING INSTRUCTIONS	06
6.TROUBLE SHOOTING	09
7.FILLING	11
8.DEFRODTING	11
9.MAINTETANCE	11
10.CLEANING	12
11.SUGGESTIONS	12
12.GENERAL SAFETY MESSAGES	13
13.NOTICE	13
14.WARRANTY	16
14.FCC WARNING	18

1.SAFETY INSTRUCTIONS

Please read this operating manual carefully before starting the appliance. Keep it in a safe place for future reference. If the appliance is passed on to another person, this instruction manual must be handed over to the user along with it. The manufacturer cannot be held liable for damage resulting from improper usage or incorrect operation.

1.1 WARNING

- This appliance is not intended for use by persons (including children) with reduced physical, sensory or mental capabilities, or lack of experience and knowledge, unless they have been given supervision or instruction concerning use of the appliance by a person responsible for their safety.
- Children should be supervised that they do not play with the appliance.
- Cleaning and user maintenance shall not be carried out by children without supervision.
- Do not store explosive substances such as aerosol cans with a flammable propellant in this appliance.
- Do not use this appliance near direct heat sources, for example, a cooker, radiator or exposing it to direct sunlight.
- The appliance shall not be exposed to rain. Place the refrigerator on a dry, protected surface, away from edges.

1.2 NOTICE

- No responsible for the damage by ignoring the safety instructions of SetPower.
- The use of accessories that are not recommended by SetPower can cause injuries and will invalidate any warranty that you may have.
- Place the products so that they do not collide against each other or break when the appliance is in motion.
- If the supply cord is damaged, it must be replaced by the manufacturer, its service agent or similarly qualified persons in order to avoid a hazard.
- Disconnect the power cable from the plug before carrying out any maintenance.

1.3 INTENDED TO USE

This appliance is intended to be used in household and similar applications such as:

- Staff kitchen areas in shops, offices and other working environments;
- Farm houses and hotels, motels and other residential type environments;
- Bed and meal environments;
- Catering and similar non-retail applications.

1.4 CAUTION

- Keep ventilation openings, clear of obstruction in the appliance enclosure or in the built-in structure.
- Do not use electrical appliances inside the food storage compartments of the appliance, unless they are of the type recommended by SetPower.
- Do not place ice or liquids which are not sealed in containers within the refrigerator.
- Do not place hot products or hot food in this appliance.

1.5 CORRECT DISPOSAL OF THIS PRODUCT

To prevent possible harm to the environment or human health from uncontrolled waste disposal, recycle it responsibly to promote the sustainable reuse of material resources. To return your used device, please use the recovery systems or contact the retailer that they can take this product for environmental safe recycling.

- Risk of child entrapment.

Before you throw away your old refrigerator or freezer:

- Take off the doors.
- Leave the shelves in place so that children may not easily climb inside.

2. DATA SHEET

Model	FC15	FC20
External Dimensions (L*W*H)	24.2×13.1×10.5 inches (615×332×268mm)	24.2×13.1×13 inches (615×332×330mm)
Capacity	15.8 Qt / 15 L	21 Qt / 20L
Net Weight	22.4 lbs (10.2 kg)	24 lbs (10.9kg)
Temperature Range	-4°F to 68°F (-20°C to +20°C)	
Installed Power	55W	
Supply Voltage	DC:12V / 24V	
Refrigerant Gas	R134a-CFC Free	
Insulation	C-pentane	
Shell Material	PP	

3. OVERVIEW

1. Lid Latches
2. Control Panel
3. Carry Handle
4. Power Input Panel
5. 12V/24V DC Power Cable

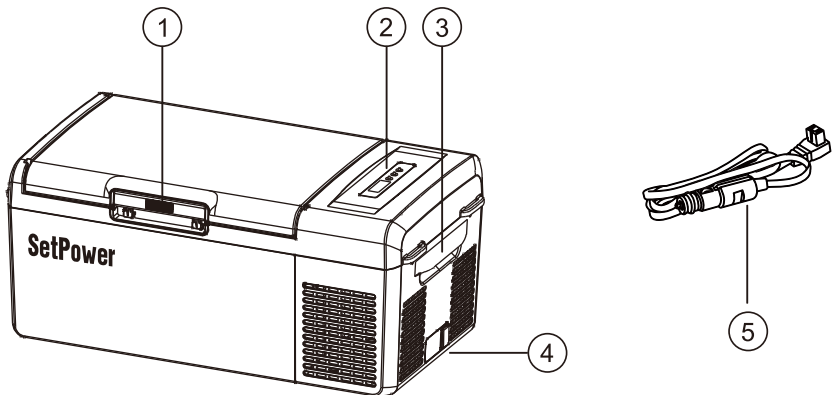

15.8Qt (15L) FRIDGE

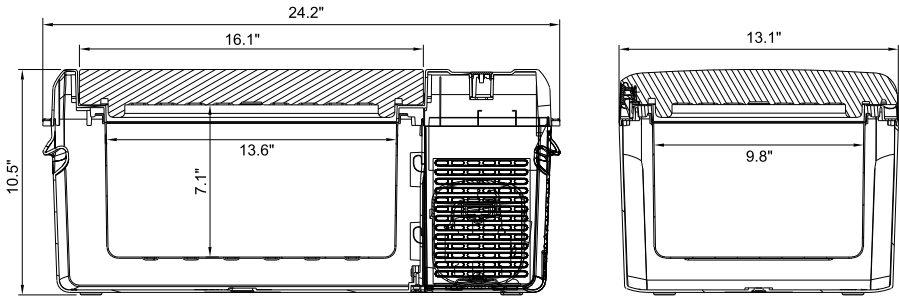

21Qt (20L) FRIDGE

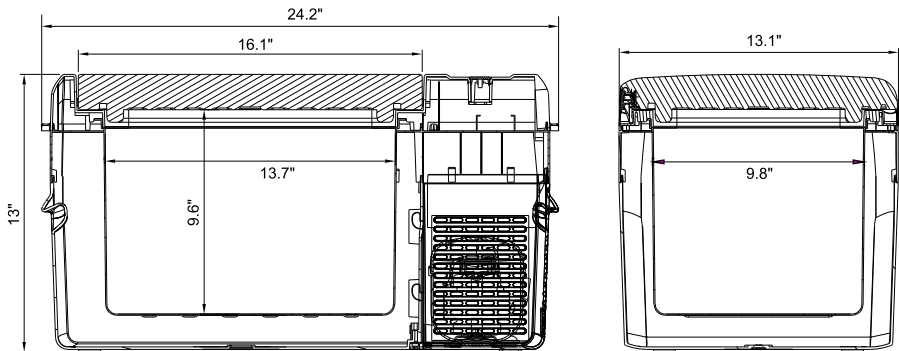

4. POWER SOURCE INSTRUCTIONS

4.1 CONNECTING WITH 12V OR 24V

- Connect the feeding cable to a direct current 12/24V DC power source.
- Make sure the polarity is right.
- If connected to an existing cigarette plug, please carefully check if power supply is sufficient.

4.2 CONNECTING WITH 110V-240V

- The Fridge/Freezer is designed to operate on DC voltage inputs only. Use the supplied AC/DC adapter to operate fridge on 240V(110V) AC.

Please note: 80W AC adapter is NOT included in the package. Need to buy separately.

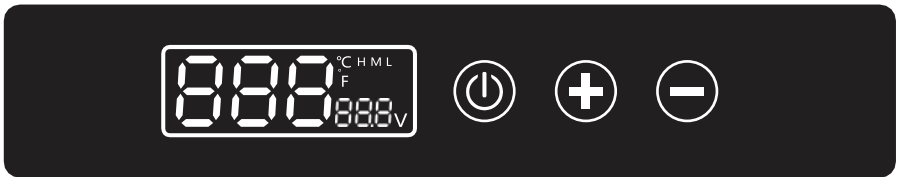

5. OPERATING INSTRUCTIONS





5.1 HOW TO USE THE REFRIGERATOR

1. Connect the fridge to a power source.
2. Short press “” to turn on or turn off the fridge.

5.2 ADJUSTING THE TEMPERATURE





With the appliance on, short press “” button to increase the temperature and the “” to decrease the temperature. The highest temp is 68°F, the lowest -4°F.

NOTE: Hold down the “” or “” button to fast scroll.

5.3 SAVING ENERGY TIPS

- Do not open the appliance frequently if unnecessary.
- Make sure leave enough space to ventilating.
- Defrost the appliance once a layer of ice forms.
- Allow warm food to cool down first before placing it in the freezer to keep cool.

5.4 SWAPPING BETWEEN FAHRENHEIT (°F) & CELSIUS (°C) & BATTERY PROTECTION SETTINGS

- To swap between C or F on the display you must have the fridge plugged in and turned off, long press “” and “” buttons at the same time for 3 seconds to enter the advanced settings.
- When the advanced settings appear, short press “” button to cycle into PR (protection settings), or F/C function (Fahrenheit/Celsius switch mode).
- With F/C showing on screen, short press “” or “” can convert Celsius to Fahrenheit. F refers to Fahrenheit, C refers to Celsius.

- With PR showing on screen (protection settings), short press “**+**” or “**-**” to set the below voltage protection levels.

5.5 BATTERY PROTECTION LEVEL

Battery protection (SWITCH POSITION)	Cut-out 12V	Cut-in 12V	Cut-out 24V	Cut-in 24V
L	9.6	10.9	21.3	22.7
M	10.4	11.7	22.8	24.2
H	11.1	12.4	24.3	25.7

What's battery protection mode?

This function is designed to prevent over-discharge and battery depletion. When the measured DC voltage is below the Cut-off value, the compressor will shut off to prevent battery depletion. After the voltage is higher than Start-up value, the compressor will go back to work again. Improper protection setting or low power voltage may cause E1 error, please lower the battery protection or recharge the battery in time.

6. TROUBLE SHOOTING

6.1 POWER CUTTING IN/OUT

- Your fridge has built in battery protection and needs a minimum 10.9 V to start and 9.6 V to continue operating.
- During operation a load is placed on the power supply and voltage can drop by as much as 2 V, especially if the wiring is insufficient (less than 6mm direct to battery) or if there is a loose connection somewhere.
- If this occurs when you try and start your SetPower and the power supply drops under 10.9 V it will not start. If this occurs when your SetPower is running and the power supply drops below 9.6 V it will stop.

6.2 COMMON 12V POWER SUPPLY ISSUES

Wiring

- Often the standard wiring from the car battery to the 12V outlet is too small.
- A minimum 6mm automotive wiring should be used and the earth should be wired directly back to the battery.

Battery

- The car battery could be old, undersized or have a dead cell causing too much voltage drop.

Connections

- The 12 V plug, car 12 V socket or any of the connections between the fridge and the battery could be faulty or have come loose since installation.

6.3 ERROR CODES

CADE	Error Type	Action
E1	Battery voltage low is low.	Check battery voltage and adjust Low Voltage Cut-Off as required.
E2	Fan failure / Frequent start-stop.	Contact point of sale to arrange further action.
E3	Compressor startup problems.	Check air vents are clear. Move fridge to cooler location(ambient temperature may be too high).
E4	Compressor's running speed fails to reach the requirements.	
E5	The model is overloading.	
E6	NTC failure(open circuit or short circuit).	

7.FILLING

- Do not put hot food items into the refrigerator. Place the products in such a way as to avoid them hitting against each other or breaking because of the movement of the vehicle.
- Make sure that the lid is always well closed and open it for as short a time as possible.

8.DEFROSTING

- Defrosting is needed when the layer of frost is thicker than 4 mm.
- To carry out this operation, turn off the refrigerator.
- Do not use sharp or cutting tools to remove the layer of frost or ice.
- Wait until complete unfreezing and then turn on again.

9.MAINTENANCE



Before carrying out any maintenance operation on the refrigerator, take the power cable out of its socket.

10. CLEANING

- Regularly clean the inside and outside of the refrigerator using only warm water and a neutral detergent.
- Subsequent to washing, rinse with clean water and dry thoroughly using a soft cloth.
- Do not use the following: special glass and mirror cleaning products, liquid, powder, or spray detergents, alcohol, ammonia or abrasive products.
- If you are not using the refrigerator, we suggest cleaning it well inside and leaving the door ajar to ventilate the interior.

11. SUGGESTIONS

Should the device fail to work or work badly, before referring to our after-sales service, make sure that:

- a) the feeding voltage is not missing;
- b) the voltage is the same as the one shown on the plate;
- c) the connections and the polarities are right;
- d) the airing grids are not covered over;
- e) the refrigerator unit is not near any heat source;
- f) the fuse of the feeding line is not blown.

12. GENERAL SAFETY MESSAGES ---



Failure to obey the following warnings could result in death or serious injury:

- ELECTRICAL SHOCK HAZARD. Do not immerse the product in water, or use it in an area that is excessively muddy.
- Do not use the cooler for any purpose other than as a mobile cooling device.



FALL HAZARD. Do not stand on the cooler. Doing so could damage the unit or cause minor to moderate injury.

13. NOTICE ---

Failure to obey the following notices could result in property damage:

- Keep sand or dirt away from the cooling system ventilation area.
- Do not leave the cooler on the deck of a boat for an extended period. Salt water damage to the cooling system, electronics, or metal hardware could occur.
- Do not expose the cooler to extreme heat.
- Only use mild soap and water to clean the cooler.

- Do not use a DC extension cord.
- Do not use a power strip or two-way splitter.
- Do not use power cord adapters of any kind other than those provided by the manufacturer.
- Do not use ice cubes or fill the cooler with water. If ice does accumulate at the bottom of the cooler, defrost the unit and use the drain plug to drain the water.
- Do not modify the unit in any way.
- Do not place hot materials (75 °F or higher) in the cooler. Allow materials to cool (50 °F or less) before placing them inside the cooler.
- Do not tip or store the cooler at an angle greater than 30° for extended periods. Compressor oil contamination of the cooling system could occur.
- Allow 2–4 inches of space around the cooler at all times for proper ventilation of the cooling system.
- The cooler must be secured at all times using straps or a mounting plate, especially in mobile applications.



The power supply cable must be replaced only by qualified technical personnel and in any case by an after sales service authorised by the Manufacturer.

SetPower is not liable in any way if you do not comply strictly with all the provisions in this manual.

- This appliance is not intended for use by persons (including children) with reduced physical, sensory or mental capabilities, or lack of experience and knowledge, unless they have been given supervision or instruction concerning use of the appliance by a person responsible for their safety.
- Children should be supervised to ensure that they do not play with the appliance.

14. WARRANTY & RETURN

7.1 Warranty

- 3-year Warranty for The Compressor
- 1-year General Warranty
- For Warranty Registration, please contact us for more information.

7.2 Customer Service

- If the product is received damaged or defective, you can contact us via these ways:
 - Customer Support Email: support@setpowerusa.com
 - Amazon Message Service
- If you email us, these information needs to be included:
 - Order ID
 - Unit Model
 - Phone number
 - Description of the Defect
 - Delivery Address
 - Videos or Photos Related to The Defect

Note:

- **Videos or photos** is preferred, because they can help us find out the reason causing the issue and improve the efficiency of solving problems.
- If calling the customer service number out of working time, you can leave a voice/text message. We will respond to you after getting back to work.

7.3 Return Policy

— Amazon-Fulfilled Order

The postage is afforded by Amazon in Amazon return window.

If the return window is expired but still in warranty, the return policy will be same as seller-fulfilled order.

— Seller-Fulfilled Order

If the warranty is not expired, the postage is afforded when the return is confirmed to be caused by **QUALITY ISSUE** of our products.

7.4 Refund & Replacement

- For returns or exchanges, all accessories must be returned in the original condition and packaging.
- After the unit is shipped, please provide us with the tracking number and carrier, so we can track it and process the refund in time.
- After the package is delivered back to our warehouse, a full refund will be initiated.
- If you file a return request on Amazon, we will process it in 48 hours and contact you via Amazon Message Service, please pay attention to your Amazon Message Box or Email in order to **avoid missing important notifications.**

15. FCC WARNING

Any Changes or modifications not expressly approved by the party responsible for compliance could void the user's authority to operate the equipment.

Note:

This equipment has been tested and found to comply with the limits for a Class B digital device, pursuant to part 15 of the FCC Rules. These limits are designed to provide reasonable protection against harmful interference in a residential installation.

This equipment generates uses and can radiate radio frequency energy and, if not installed and used in accordance with the instructions, may cause harmful interference to radio communications.

However, there is no guarantee that interference will not occur in a particular installation.

If this equipment does cause harmful interference to radio or television reception, which can be determined by turning the equipment off and on, the user is encouraged to try to correct the interference by one or more of the following measures:

- Reorient or relocate the receiving antenna.
- Increase the separation between the equipment and receiver.
- Connect the equipment into an outlet on a circuit different from that to which the receiver is connected.

- Consult the dealer or an experienced radio/TV technician for help.

This device complies with part 15 of the FCC Rules. Operation is subject to the following two conditions:
(1) This device may not cause harmful interference, and
(2) this device must accept any interference received, including interference that may cause undesired operation.

This equipment complies with FCC radiation exposure limits set forth for an uncontrolled environment. This equipment should be installed and operated with minimum distance 20cm between the radiator & your body.

OUR GUARANTEE

SetPower product comes with a 3-year warranty on the compressor and 1 year warranty on all other parts for your peace of mind. In the unlikely event this product fails when used according to our user guide, we will either repair or replace it. For full warranty terms and conditions on this product, please see the user guide.

We'd welcome you contact us support@setpowerusa.com if you have any question about the product.

Quality Service Guarantee

This product is warranted for 3 years on the compressor and 1 year for all other parts from the date of purchase. Our goods come with guarantees that cannot be excluded under the Local Consumer Law. You are entitled to a replacement or refund for a major failure and compensation for any other reasonably foreseeable loss or damage. You are also entitled to have the goods repaired or replaced if the goods fail to be of acceptable quality and the failure does not amount to a major failure. Warranty does not cover products that have not been used in accordance with user guide or are outside the warranty terms and conditions.



official@setpowerusa.com

support@setpowerusa.com

SetPower

3-YEAR WARRANTY

