

FLAT PANEL 35mm (1 3/8") Five Flat Panel 9mm Standard Square Sticking Veneered HG



Last Update: 03/01/2021

FSC Wood Statistic

Size in Inch Decimals:

Size in Milimeter:

Drawing Code:

**IMPRESSA  
DOORS.**

Drawing Scale: 1:10

0.024425m<sup>3</sup>

1.38 x 18 x 80

35 x 457 x 2032

A009434

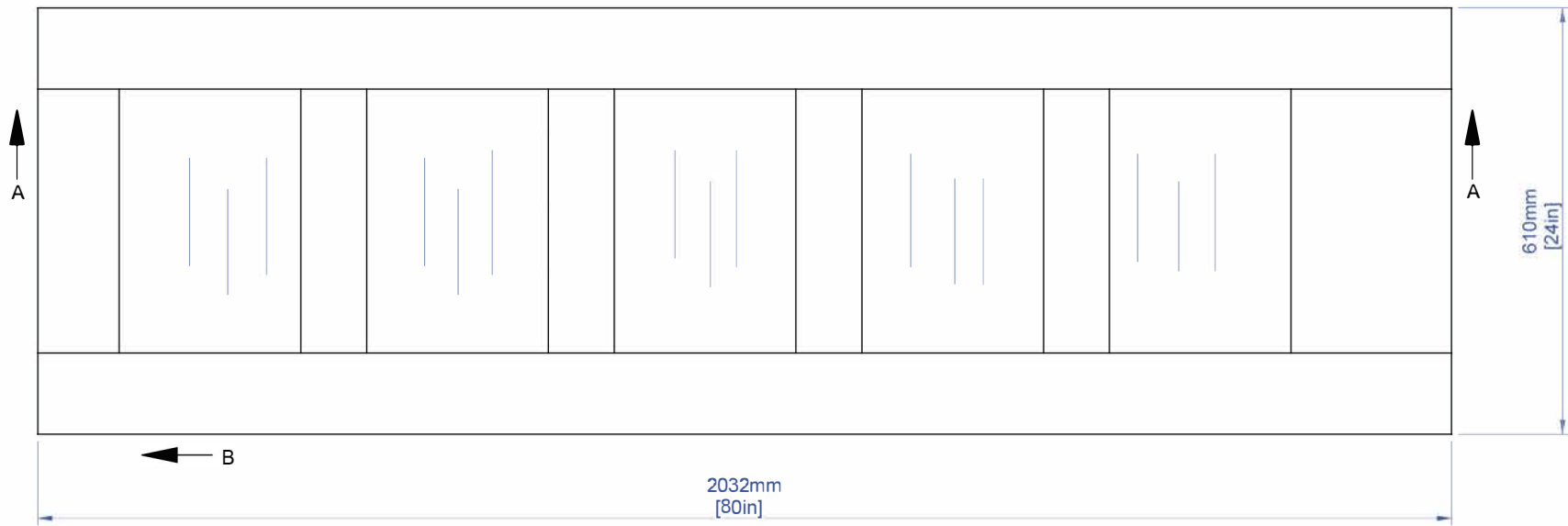
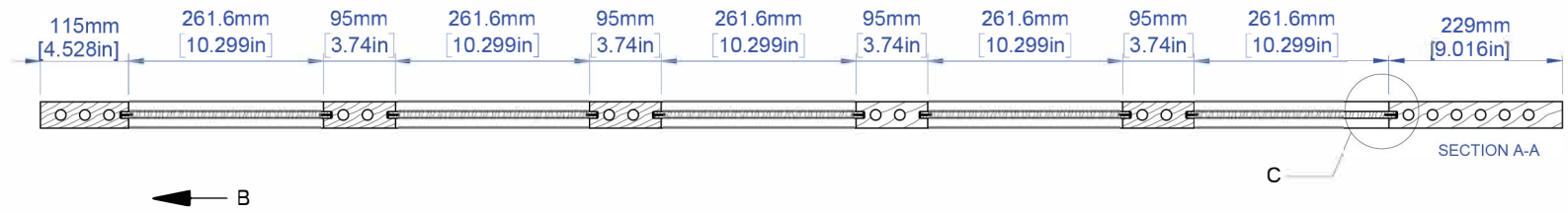

FLAT PANEL 35mm (1 3/8") Five Flat Panel 9mm Standard Square Sticking Veneered HG

	Last Update: 03/01/2021	FSC Wood Statistic	Size in Inch Decimals:	Size in Milimeter:	Drawing Code:	
	Drawing Scale: 1:10	0.030064m <sup>3</sup>	1.38 x 24 x 80	35 x 610 x 2032	A009431	

All products may incur slight alterations or modifications without any prior notice.

Measures mentioned herein are subject to the usual tolerances in the manufacturing process and can vary up to +/- 1/16" Inch decimals (ca. 1.58750 mm)

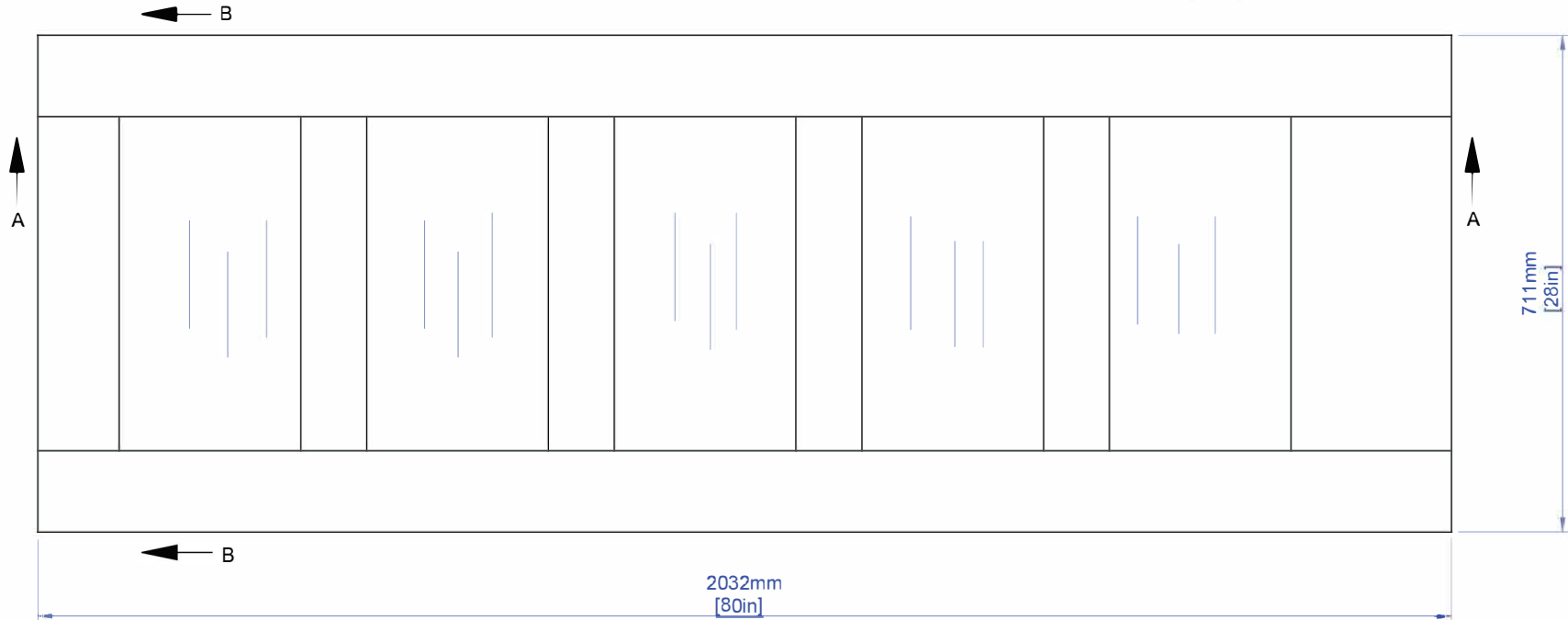
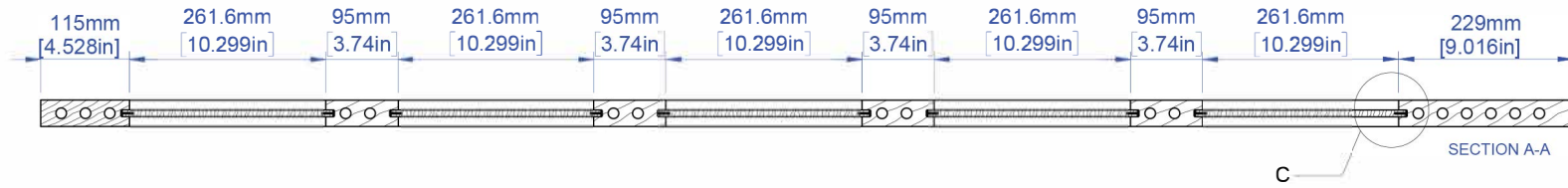
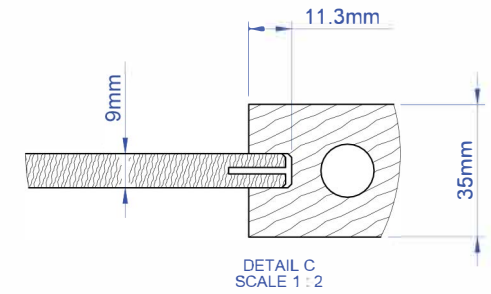
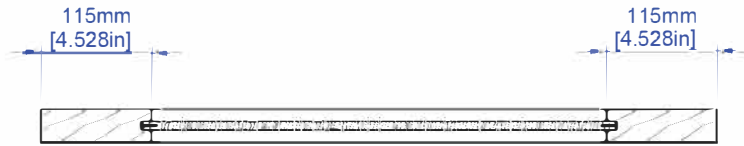

FLAT PANEL 35mm (1 3/8") Five Flat Panel 9mm Standard Square Sticking Veneered HG



Last Update: 03/01/2021

FSC Wood Statistic

Size in Inch Decimals:

Size in Milimeter:

Drawing Code:

IMPRESSA  
DOORS.

Drawing Scale: 1:10

0.033774m<sup>3</sup>

1.38 x 28 x 80

35 x 711 x 2032

A009429

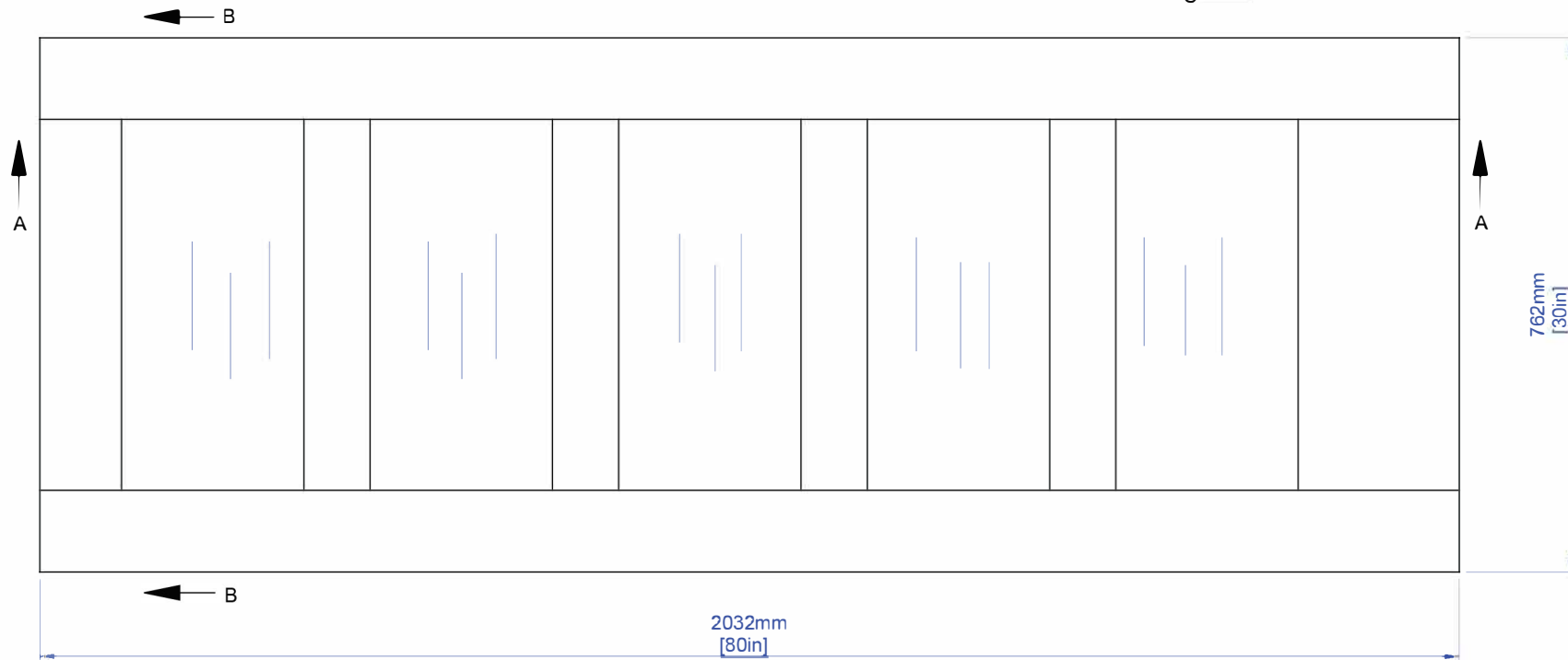
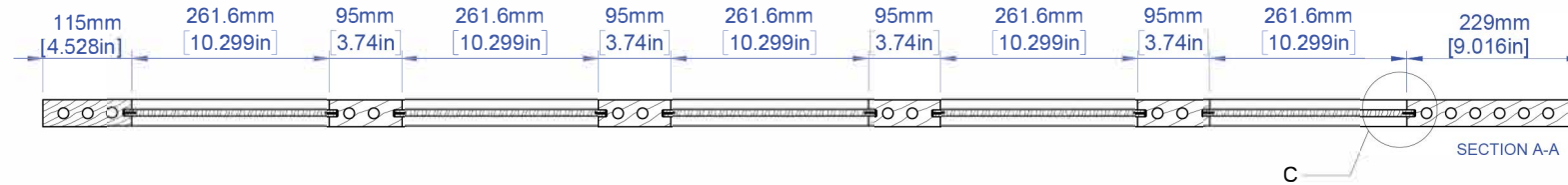
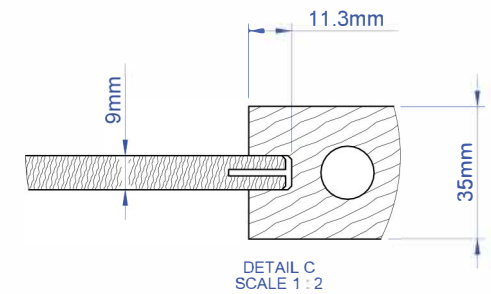
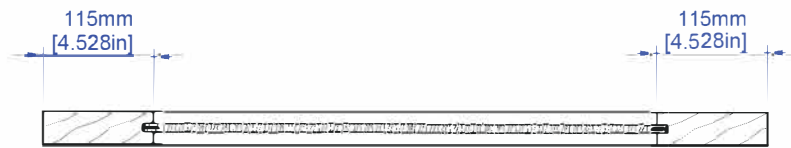

FLAT PANEL 35mm (1 3/8") Five Flat Panel 9mm Standard Square Sticking Veneered HG



Last Update: 03/01/2021

FSC Wood Statistic

Size in Inch Decimals:

Size in Millimeter:

Drawing Code:

**IMPRESSA  
DOORS.**

Drawing Scale: 1:10

0.035665m<sup>3</sup>

1.38 x 30 x 80

35 x 762 x 2032

A009428

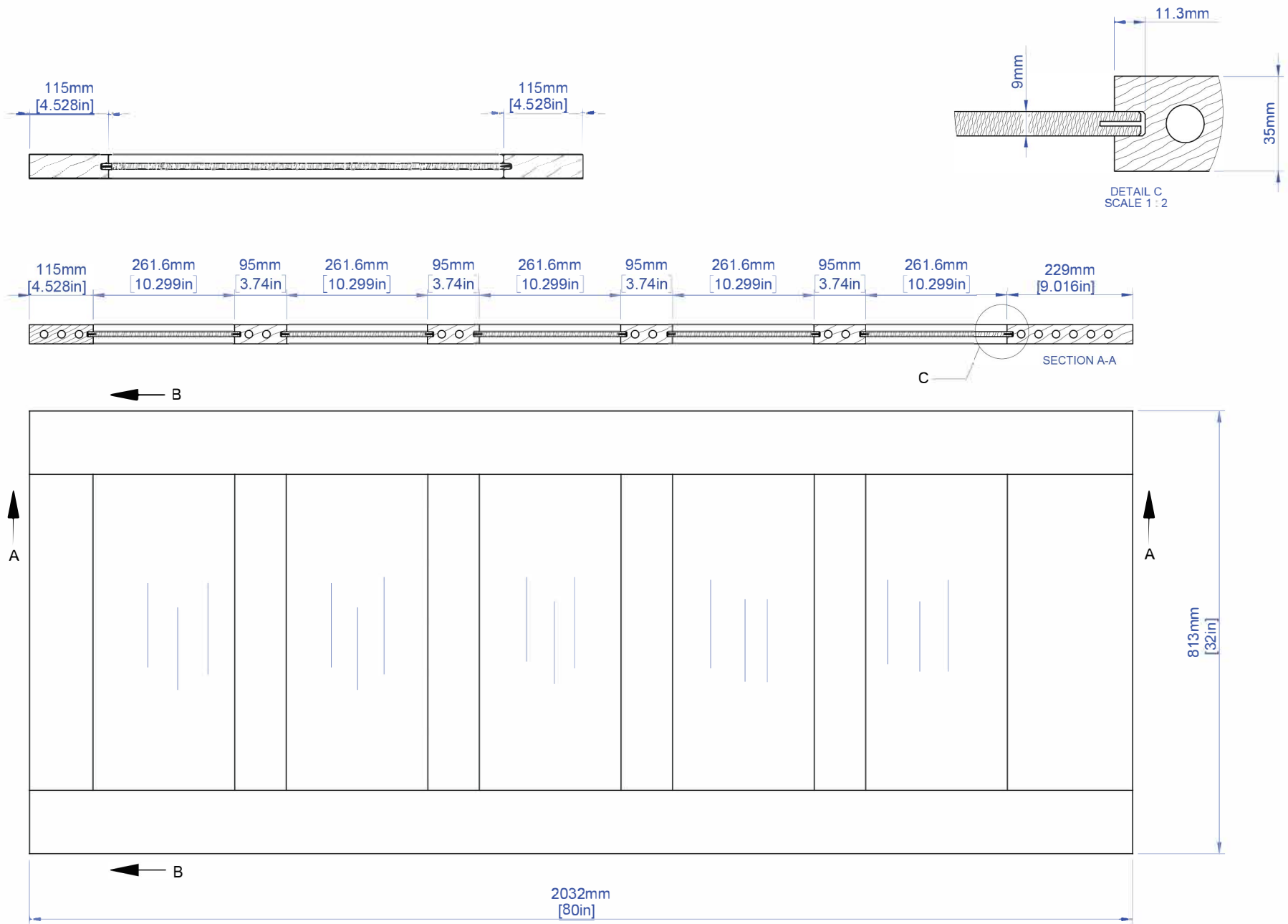

FLAT PANEL 35mm (1 3/8") Five Flat Panel 9mm Standard Square Sticking Veneered HG



Last Update: 03/01/2021

FSC Wood Statistic

Size in Inch Decimals:

Size in Milimeter:

Drawing Code:



Drawing Scale: 1:10

0.037557m<sup>3</sup>

1.38 x 32 x 80

35 x 813 x 2032

A009427

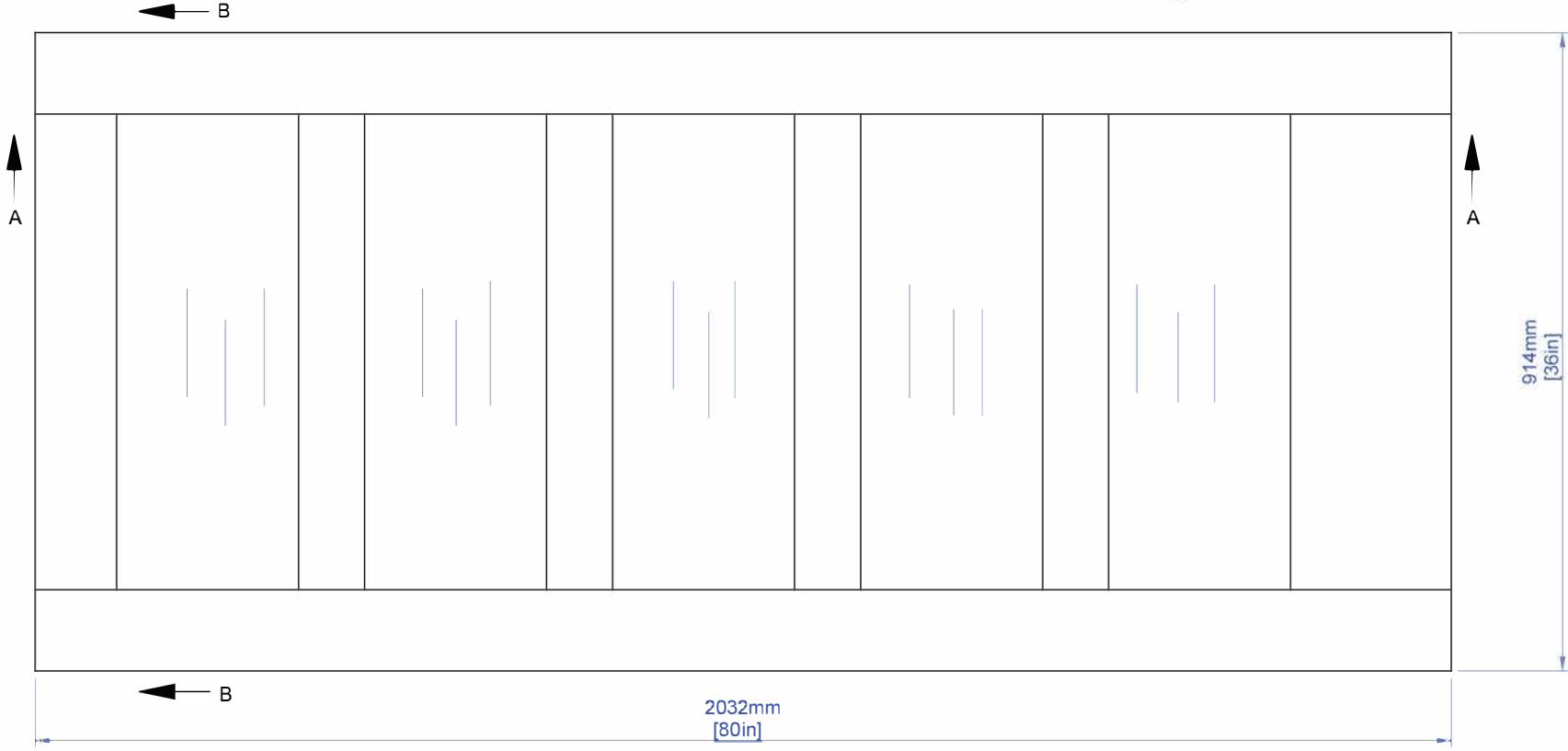
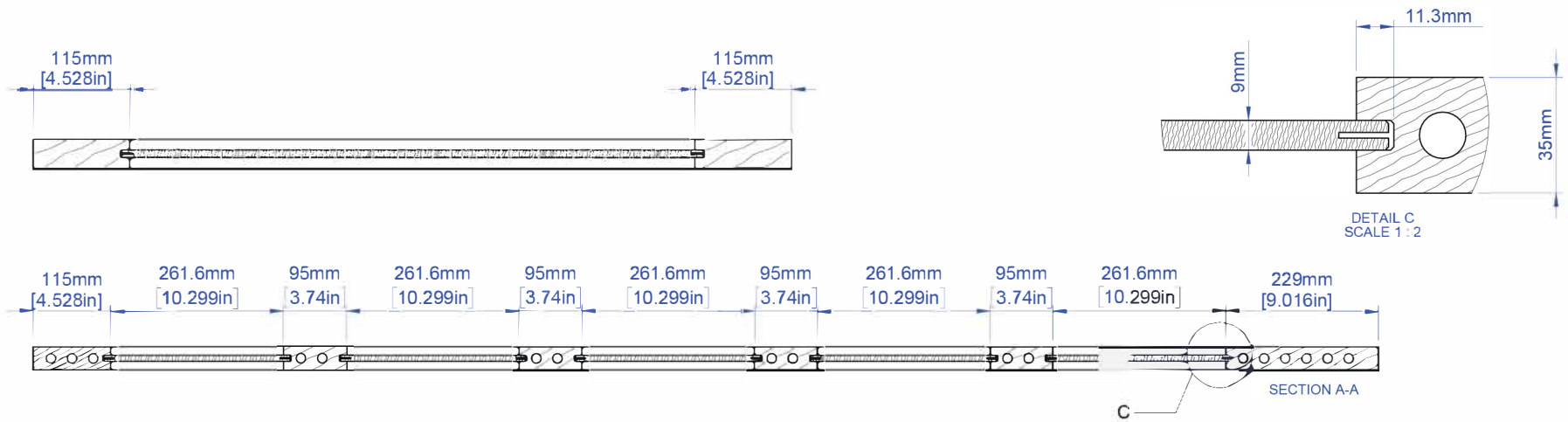

FLAT PANEL 35mm (1 3/8") Five Flat Panel 9mm Standard Square Sticking Veneered HG

	Last Update: 03/01/2021	FSC Wood Statistic	Size in Inch Decimals:	Size in Milimeter:	Drawing Code:	
	Drawing Scale: 1:10	0.041266m <sup>3</sup>	1.38 x 36 x 80	35 x 914 x 2032	A009422	

All products may incur slight alterations or modifications without any prior notice. Measures mentioned herein are subject to the usual tolerances in the manufacturing process and can vary up to +/- 1/16" Inch decimals (ca. 1,58750 mm)