

# User Manual

## Off Grid Solar Inverter Split Phase 4KW-12KW

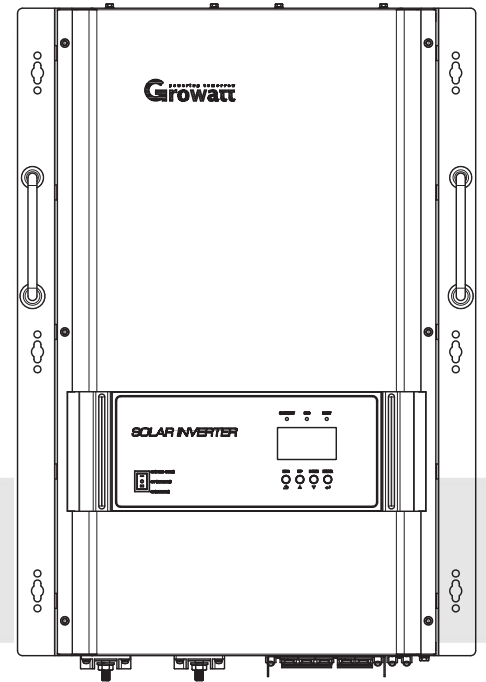

# Table Of Contents

Information on this Manual.....	1
<b>Validity</b> .....	<b>1</b>
<b>Scope</b> .....	<b>1</b>
<b>Target Group</b> .....	<b>1</b>
<b>Safety Instructions</b> .....	<b>1</b>
<b>Symbols</b> .....	<b>2</b>
Introduction.....	3
<b>Features</b> .....	<b>3</b>
<b>Product Overview</b> .....	<b>4</b>
Installation.....	5
<b>Unpacking and Inspection</b> .....	<b>5</b>
<b>Preparation</b> .....	<b>5</b>
<b>Mounting the Unit</b> .....	<b>5</b>
<b>Battery Connection</b> .....	<b>6</b>
<b>AC Input/Output Connection</b> .....	<b>7</b>
<b>PV Connection</b> .....	<b>9</b>
<b>Communication Connection</b> .....	<b>11</b>
<b>Dry Contact Signal</b> .....	<b>11</b>
<b>Electrical Performance</b> .....	<b>12</b>
Operation.....	13
<b>Power ON/OFF</b> .....	<b>13</b>
<b>Operation and Display Panel</b> .....	<b>13</b>
LCD Display Icons.....	14
LCD Setting.....	16
<b>Display Setting</b> .....	<b>20</b>
<b>Operating Mode Description</b> .....	<b>23</b>
<b>Fault Reference Code</b> .....	<b>24</b>
<b>Warning Indicator</b> .....	<b>26</b>
Trouble Shooting.....	27
Specifications.....	28

## Information on this Manual

### Validity

This manual is valid for the following devices:

- ▶ SPF 4000T DVM
- ▶ SPF 5000T DVM
- ▶ SPF 6000T DVM
- ▶ SPF 8000T DVM
- ▶ SPF 10000T DVM
- ▶ SPF 12000T DVM

### Scope

This manual describes the assembly, installation, operation and troubleshooting of this unit. Please read this manual carefully before installations and operations.

### Target Group

This document is intended for qualified persons and end users. Tasks that do not require any particular qualification can also be performed by end users. Qualified persons must have the following skills:

- ▶ Knowledge of how an inverter works and is operated
- ▶ Training in how to deal with the dangers and risks associated with installing and using electrical devices and installations
- ▶ Training in the installation and commissioning of electrical devices and installations
- ▶ Knowledge of the applicable standards and directives
- ▶ Knowledge of and compliance with this document and all safety information

### Safety Instructions



**WARNING: This chapter contains important safety and operating instructions. Read and keep this manual for future reference.**

1. **CAUTION** – Only qualified personnel can install this device with battery.
2. Before using the unit, read all instructions and caution marks on the unit, understand the batteries and all appropriate sections of this manual.
3. **CAUTION** --To reduce risk of injury, charge only deep-cycle lead acid type rechargeable batteries. Other types of batteries may burst, causing personal injury and damage.
4. **NEVER** cause AC output and DC input short circuited. Do NOT connect to the mains when DC input short circuits.
5. **NEVER** charge a frozen battery.
6. Do not disassemble the unit. Take it to a qualified service center when service or repair is required. Incorrect re-assembly may result in a risk of electric shock or fire.
7. To reduce risk of electric shock, disconnect all wiring before attempting any maintenance or cleaning. Turning off the unit will not reduce this risk.

8. Be very cautious when working with metal tools on or around batteries. A potential risk, such as dropping a tool to spark or short circuit batteries or other electrical parts, could cause an explosion.
9. For optimum operation of this off grid solar inverter, please follow required spec to select appropriate cable size. It's very important to correctly operate this off grid solar inverter.
10. Please strictly follow installation procedure when you want to disconnect AC or DC terminals. Please refer to INSTALLATION section of this manual for the details.
11. **GROUNDING INSTRUCTIONS** –This off grid solar inverter should be connected to a permanent grounded wiring system. Be sure to comply with local requirements and regulation to install this inverter.
12. **Warning!!** Only qualified service persons are able to service this device. If errors still persist after following troubleshooting table, please send this off grid solar inverter back to local dealer or service center for maintenance.

## Symbols

Symbol	Explanation
	Indicates a hazardous situation which, if not avoided, can result in machine damage or people injury Refer to page 24
	Indicates a hazardous situation which, if not avoided, can result in machine damage or people injury Refer to page 25
	Indicates overload which, if not avoided, can result in machine damage or people injury Refer to page 25

## Introduction

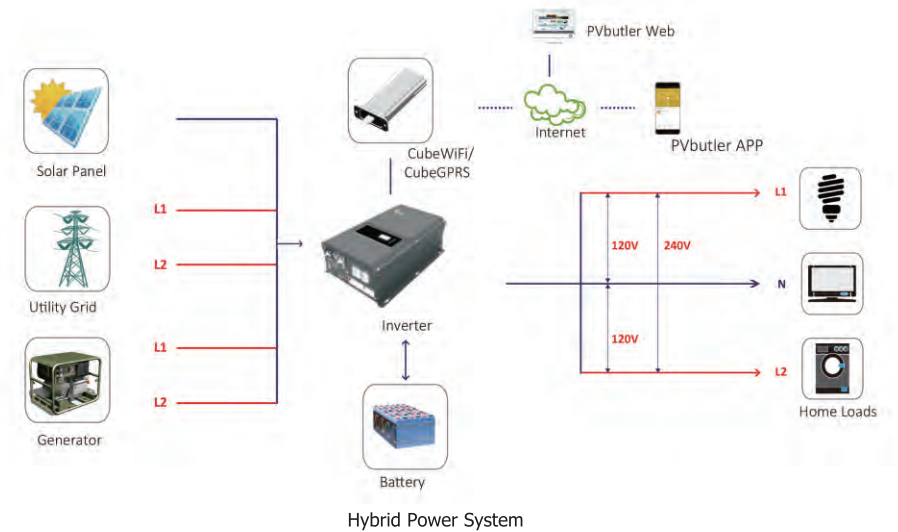

This is a multifunctional split-phase output off grid solar inverter, integrated with a MPPT solar charge controller, a low frequency pure sine wave inverter and a UPS function module in one machine, which is perfect for off grid backup power and self-consumption applications.

The whole system also need other devices to achieve complete running such as PV modules, generator, or utility grid. Please consult with your system integrator for other possible system architectures depending on your requirements. The WiFi / GPRS module is a plug-and-play monitoring device to be installed on the inverter. With this device, users can monitor the status of the PV system from the mobile phone or from the website anytime anywhere.

## Features

- ▶ Rated power 4KW to 12KW
- ▶ MPPT solar charge controller
- ▶ Low frequency inverter with large transformer
- ▶ Pure sine wave AC output
- ▶ Overload, short circuit and deep discharge protection
- ▶ Configurable AC/ solar input priority via LCD setting
- ▶ Compatible to mains voltage or generator power
- ▶ WIFI/ GPRS remote monitoring (optional)

## Product Overview

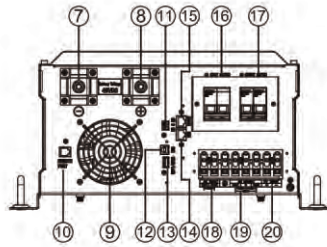
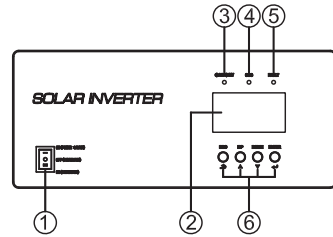
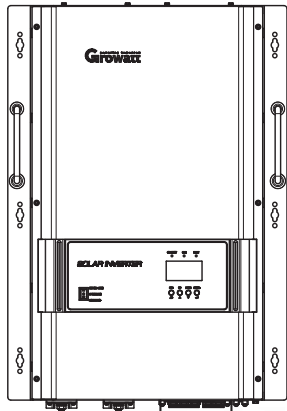

(4-6KW)

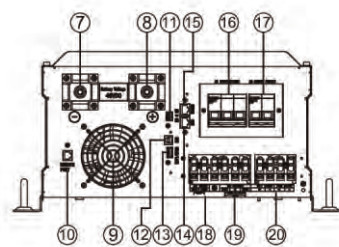

(8-12KW)

- |                           |                         |
|---------------------------|-------------------------|
| 1. ON/OFF power switch    | 2. LCD display          |
| 3. Status indicator       | 4. Charging indicator   |
| 5. Fault indicator        | 6. Function buttons     |
| 7. Battery "-"            | 8. Battery "+"          |
| 9. Fan                    | 10. Remote control port |
| 11. Dry contact           | 12. USB port            |
| 13. WiFi/GPRS device port | 14. BMS (optional)      |
| 15. RS 485 (optional)     | 16. AC input switch     |
| 17. AC output switch      | 18. AC input            |
| 19. AC output             | 20. PV input            |

## Installation

### Unpacking and Inspection

Before installation, please inspect the unit. Be sure that nothing inside the package is damaged. You should have received the following items in the package:

- ▶ The unit x 1
- ▶ User manual x 1
- ▶ Communication cable x 1
- ▶ Software CD x 1

### Preparation

Before connecting all wiring, please take off bottom cover by removing eight screws as shown below.

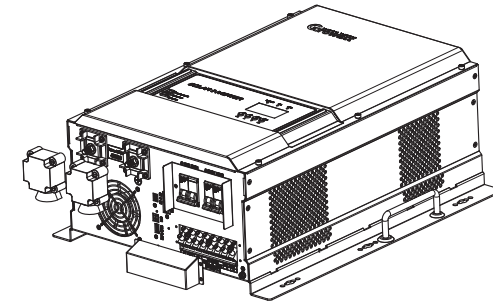

### Mounting the Unit

Consider the following points before selecting where to install:

- ▶ Do not mount the inverter on flammable construction materials.
- ▶ Mount on a solid surface
- ▶ Install this inverter at eye level in order to allow the LCD display to be read at all times.
- ▶ The ambient temperature should be between 0°C and 55°C to ensure optimal operation.
- ▶ The recommended installation position is to be adhered to the wall vertically.
- ▶ Be sure to keep other objects and surfaces as shown in the right diagram to guarantee sufficient heat dissipation and to have enough space for removing wires.

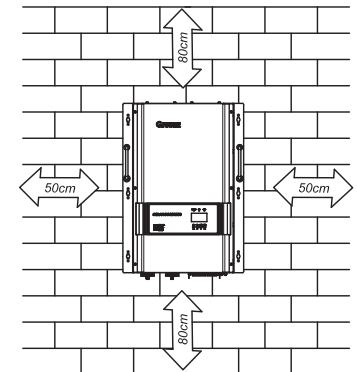

**SUITABLE FOR MOUNTING ON CONCRETE OR OTHER NON-COMBUSTIBLE SURFACE ONLY**

**Install the unit by screwing the six setscrews.**

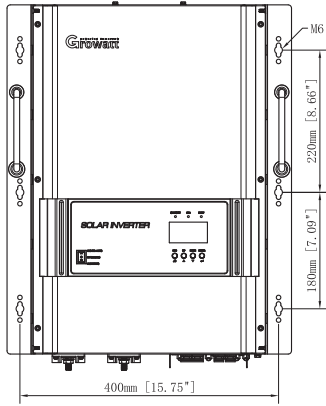

**(4-6KW)**

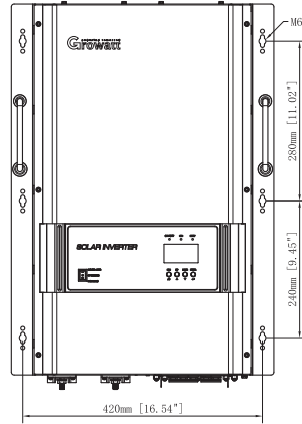

**(8-12KW)**

**Battery Connection**

**CAUTION:** For safety operation and regulation compliance, it's requested to install a separate DC over-current protector or disconnect device between battery and inverter. It may not be requested to have a disconnect device in some applications, however, it's still requested to have over-current protection installed. Please refer to typical amperage in below table as required fuse or breaker size.

**WARNING!** All wiring must be performed by a qualified person.

**WARNING!** It's very important for system safety and efficient operation to use appropriate cable for battery connection. To reduce risk of injury, please use the proper recommended cable and terminal size as below.

**Recommended battery cable and terminal size:**

Model	Battery Voltage	Wire Gage/min
4kw	48V	1*2AWG
5kw	48V	1*1AWG
6kw	48V	2*3AWG
8kw	48V	2*2AWG
10kw	48V	2*1AWG
12kw	48V	3*2AWG

Please follow below steps to implement battery connection:

1. Assemble battery ring terminal based on recommended battery cable and terminal size.
2. Connect all battery packs as units requires. It's suggested to connect at least 200Ah capacity battery for 4KW~6KW model and at least 400Ah capacity battery for 8KW~12KW model.
3. Insert the ring terminal of battery cable flatly into battery connector of inverter and make sure the bolts are tightened with torque of 2-3 Nm. Make sure polarity at both the battery and the inverter/charge is correctly connected and ring terminals are tightly screwed to the battery terminals.

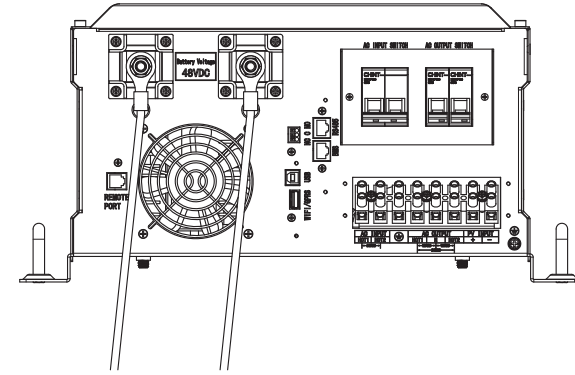

**WARNING: Shock Hazard**  
Installation must be performed with care due to high battery voltage in series.

**CAUTION!!** Do not place anything between the flat part of the inverter terminal and the ring terminal. Otherwise, overheating may occur.  
**CAUTION!!** Do not apply anti-oxidant substance on the terminals before terminals are connected tightly.  
**CAUTION!!** Before making the final DC connection or closing DC breaker/disconnector, be sure positive (+) must be connected to positive (+) and negative (-) must be connected to negative (-).

**AC Input/Output Connection**

**CAUTION!!** Before connecting to AC input power source, please install a **separate** AC breaker between inverter and AC input power source. This will ensure the inverter can be securely disconnected during maintenance and fully protected from over current of AC input. The recommended spec of AC breaker is 40A for 4KW~6KW, 80A for 8KW~12KW.

**CAUTION!!** There are two terminal blocks with "IN" and "OUT" markings. Please do NOT mis-connect input and output connectors.

**WARNING!** All wiring must be performed by a qualified personnel.

**WARNING!** It's very important for system safety and efficient operation to use appropriate cable for AC input connection. To reduce risk of injury, please use the proper recommended cable size as below.

**Suggested cable requirement for AC wires**

Model	Gauge	Torque Value
4KW/5KW	10 AWG	1.4~ 1.6 Nm
6KW/8KW	8 AWG	1.4~ 1.6 Nm
10KW/12KW	6 AWG	1.6~ 1.8 Nm

## AC Wiring

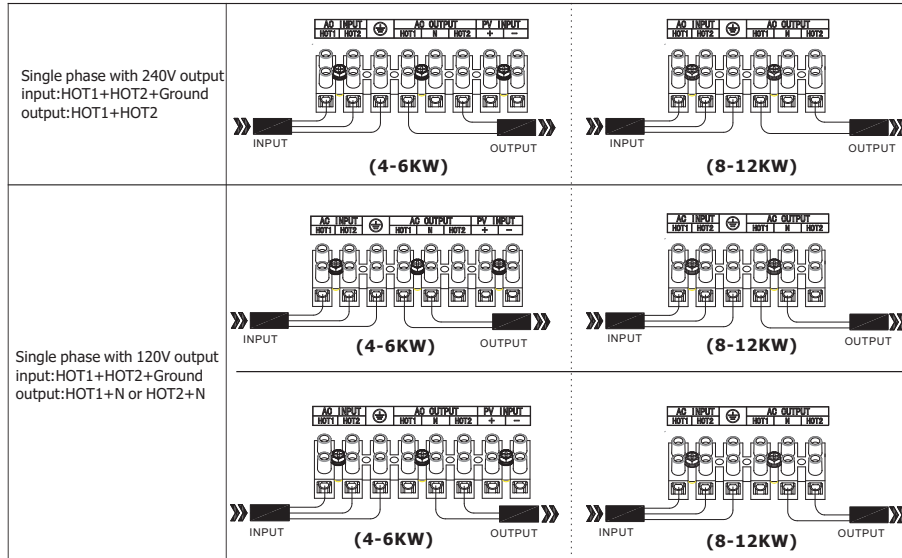

Please follow below steps to implement AC input/output connection:

1. Before making AC input/output connection, be sure to open DC protector or disconnecter first.
2. Remove insulation sleeve 10mm for six conductors. And shorten phase L and neutral conductor N 3 mm.
3. Insert AC input wires according to polarities indicated on terminal block and tighten the terminal screws. Be sure to connect PE protective conductor  $\oplus$  first.

$\oplus$  → Ground (yellow-green)

L → LINE (brown or black)

N → Neutral (blue)

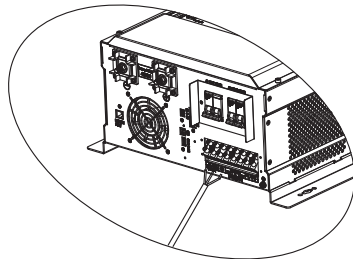

### WARNING:

Be sure that AC power source is disconnected before attempting to hardwire it to the unit.

4. Then, insert AC output wires according to polarities indicated on terminal block and tighten terminal screws. Be sure to connect PE protective conductor  $\oplus$  first.

$\oplus$  → Ground (yellow-green)

L → LINE (brown or black)

N → Neutral (blue)

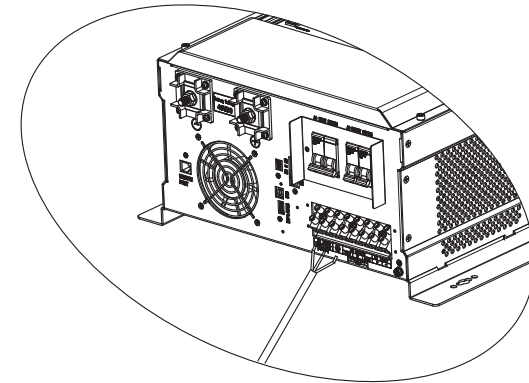

5. Make sure the wires are securely connected.

### CAUTION: Important

Be sure to connect AC wires with correct polarity. If L and N wires are connected reversely, it may cause utility short-circuited when these inverters are worked in parallel operation.

**CAUTION:** Appliances such as air conditioner are required at least 2~3 minutes to restart because it's required to have enough time to balance refrigerant gas inside of circuits. If a power shortage occurs and recovers in a short time, it will cause damage to your connected appliances. To prevent this kind of damage, please check with manufacturer of air conditioner that if it's equipped with time-delay function before installation. Otherwise, this off grid solar inverter will trigger overload fault and cut off output to protect your appliance but sometimes it still causes internal damage to the air conditioner.

## PV Connection

**CAUTION:** Before connecting to PV modules, please install **separately** a DC circuit breaker between inverter and PV modules.

**WARNING!** All wiring must be performed by a qualified personnel.

**WARNING!** It's very important for system safety and efficient operation to use appropriate cable for PV module connection. To reduce risk of injury, please use the proper recommended cable size as below.

Model	Typical Amperage	Cable Size	Torque
4KW/5KW/6KW	80A	8AWG	1.6~1.8 Nm
8KW/10KW/12KW	120A	8AWG	1.6~1.8 Nm

### PV Module Selection:

When selecting proper PV modules, please be sure to consider below parameters:

1. Open circuit Voltage (Voc) of PV modules not exceeds max. PV array open circuit voltage of inverter.
2. Open circuit Voltage (Voc) of PV modules should be higher than min. battery voltage.

Solar Charging Mode	
<b>INVERTER MODEL</b>	<b>4KW/5KW/6KW/8KW/10KW/12KW</b>
<b>Max. PV Array Open Circuit Voltage</b>	150Vdc
<b>PV Array MPPT Voltage Range</b>	60~145Vdc
<b>Min. battery voltage for PV charge</b>	34Vdc

Please follow below steps to implement PV module connection:

1. Remove insulation sleeve 10 mm for positive and negative conductors.
2. Check correct polarity of connection cable from PV modules and PV input connectors. Then, connect positive pole (+) of connection cable to positive pole (+) of PV input connector. Connect negative pole (-) of connection cable to negative pole (-) of PV input connector.
3. Make sure the wires are securely connected.

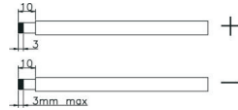

### PV Wiring

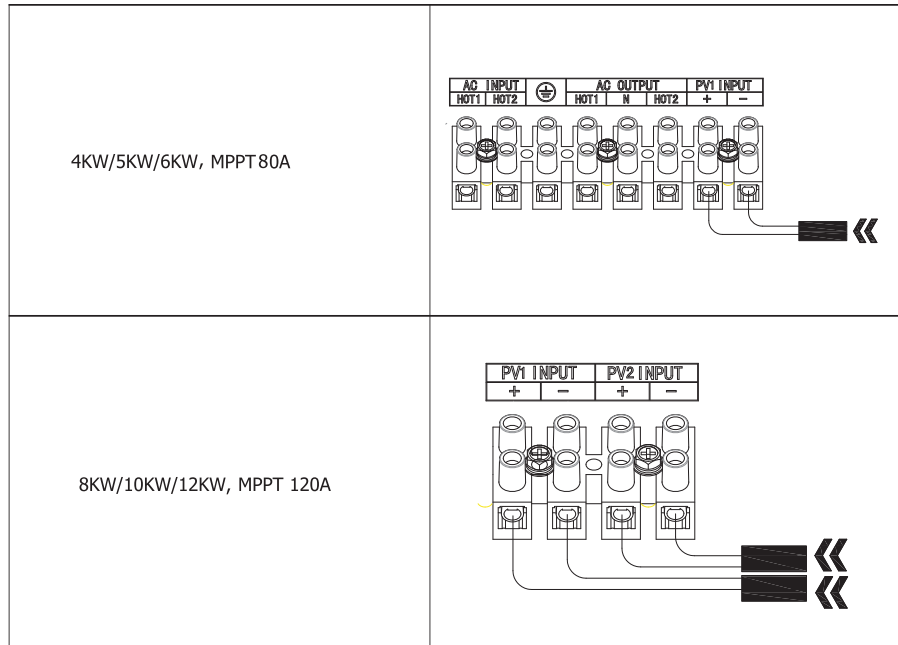

### Communication Connection

Please use supplied communication cable to connect to inverter and PC. Insert bundled CD into a computer and follow on-screen instruction to install the monitoring software. For the detailed software operation, please check user manual of software inside of CD.

### Dry Contact Signal

There is one dry contact (3A/250VAC) available on the rear panel. It could be used to deliver signal to generator when battery voltage reaches warning level.

Unit Status	Condition	Dry contact port:			
		NC & C	NO & C		
Power Off	Unit is off and no output is powered.	Close	Open		
Power On	Output is powered from Utility.	Close	Open		
	Output is powered from Battery or Solar.	Program 01 set as Utility	Battery voltage < Low DC warning voltage	Open	Close
			Battery voltage > Setting value in Program 13 or battery charging reaches floating stage	Close	Open
	Program 01 is set as SBU or Solar first	Battery voltage < Setting value in Program 12	Open	Close	
		Battery voltage > Setting value in Program 13 or battery charging reaches floating stage	Close	Open	

## Electrical Performance

### AC Charger

The inverter is equipped with an active PFC (power factor correction) multistage battery charger. The PFC feature is used to control the amount of power used to charge the batteries in order to obtain a power factor as close as possible to 1.

When AC voltage is in the range of 154~260 VAC, the charging current is 100%.

The inverter is with a strong charging current, 100Amp for 12KW model, and the charge current can be adjusted from 10A~100A . This will be helpful when using on a small capacity battery bank.

There are mainly 3 stages:

**Bulk Charging:** This is the initial stage of charging. While Bulk Charging, the charger supplies the battery with controlled constant current. The charger will remain in Bulk charge until the absorption charge voltage is achieved.

**Absorb Charging:** This is the second charging stage and begins after the absorb voltage has been reached. Absorb charging provides the batteries with a constant voltage and reduces the DC charging current in order to maintain the absorb voltage setting.

In this period , the inverter will start a T1 time; the charger will keep the boost voltage in Boost CV mode until the T1 time has run out. When charging current is <0.01C or the time is over 12 hours, then drop the voltage down to the float voltage.

**Float Charging:** The third charging stage occurs at the end of the absorb charging time. During float charging, the charge voltage is reduced to the float charge voltage. In this stage, the battery are kept fully charged and ready if needed by the inverter.

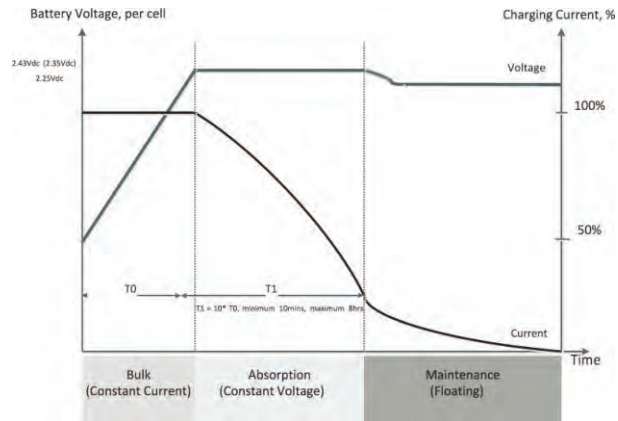

AC charging current

Model	Battery Voltage	Max. AC Charging Current
4KW	48V	40A
5KW	48V	50A
6KW	48V	60A
8KW	48V	70A
10KW	48V	80A
12KW	48V	100A

## Operation

### Power ON/OFF

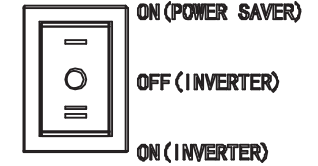
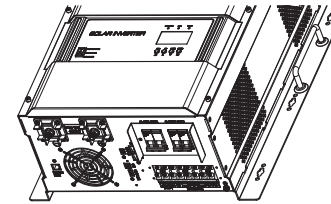

Once the unit has been properly installed and the batteries are connected well, simply press On/Off switch (located on the button of the case) to turn on the unit.

### Operation and Display Panel

The operation and display panel, shown in below chart, is on the front panel of the inverter. It includes three indicators, four function keys and a LCD display, indicating the operating status and input/output power information.

1. LCD display
2. Status indicator
3. Charging indicator
4. Fault indicator
5. Function buttons

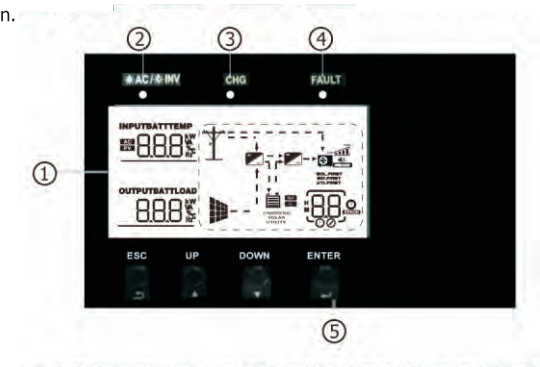

### LED Indicator

LED Indicator		Messages	
☀️ AC / 🌞 INV	Green	Solid On	Output is powered by utility in Line mode.
		Flashing	Output is powered by battery or PV in battery mode.
🌞 CHG	Green	Solid On	Battery is fully charged.
		Flashing	Battery is charging.
⚠️ FAULT	Red	Solid On	Fault occurs in the inverter.
		Flashing	Warning condition occurs in the inverter.

### Function Buttons

Button	Description
ESC	To exit setting mode
UP	To go to previous selection
DOWN	To go to next selection
ENTER	To confirm the selection in setting mode or enter setting mode



## LCD Display Icons

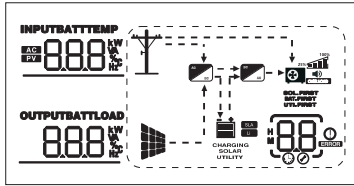

Icon	Function Description	
<b>Input Source Information</b>		
	Indicates the AC input.	
	Indicates the PV input	
	Indicate input voltage, input frequency, PV voltage, battery voltage and charger current.	
<b>Configuration Program and Fault Information</b>		
	Indicates the setting programs.	
	Indicates the warning and fault codes.	
	Warning: flashing with warning code.	
	Fault:lighting with fault code	
<b>Output Information</b>		
	Indicate output voltage, output frequency, load percent, load in VA, load in Watt and discharging current.	
<b>Battery Information</b>		
	Indicates battery level by 0-24%, 25-49%, 50-74% and 75-100% in battery mode and charging status in line mode.	
	These two signs indicate the charge priority. SOLAR indicates solar first. UTILITY indicate utility first. SOLAR blinking indicates solar only; SOLAR and UTILITY both on indicates combined charging.	
In AC mode, it will present battery charging status.		
Status	Battery voltage	LCD Display
Constant Current mode / Constant Voltage mode	<2V/cell	4 bars will flash in turns.
	2 ~ 2.083V/cell	Bottom bar will be on and the other three bars will flash in turns.
	2.083 ~ 2.167V/cell	Bottom two bars will be on and the other two bars will flash in turns.
Floating mode. Batteries are fully charged.	> 2.167 V/cell	Bottom three bars will be on and the top bar will flash.

In battery mode, it will present battery capacity.

Load Percentage	Battery Voltage	LCD Display
Load >50%	< 1.717V/cell	
	1.717V/cell ~ 1.8V/cell	
	1.8 ~ 1.883V/cell	
	> 1.883 V/cell	
50%> Load > 20%	< 1.817V/cell	
	1.817V/cell ~ 1.9V/cell	
	1.9 ~ 1.983V/cell	
Load < 20%	> 1.983	
	< 1.867V/cell	
	1.867V/cell ~ 1.95V/cell	
	1.95 ~ 2.033V/cell	
> 2.033		

### Load Information

	Indicates overload.			
	Indicates the load level by 0-24%, 25-49%, 50-74% and 75-100%.			
	0%~24%	25%~49%	50%~74%	75%~100%

### Mode Operation Information

	Indicates unit connects to the mains.
	Indicates unit connects to the PV panel.
	Indicates load is supplied by utility power.
	Indicates the utility charger circuit is working.
	Indicates the DC/AC inverter circuit is working.
	These three signs indicate the output priority. SOL.FIRST indicates solar first. BAT.FIRST indicates battery first. UTI.FIRST indicates utility first.

### Mute Operation

	Indicates unit alarm is disabled.
--	-----------------------------------

## LCD Setting

After pressing and holding ENTER button for 3 seconds, the unit will enter setting mode. Press “UP” or “DOWN” button to select setting programs. And then, press “ENTER” button to confirm the selection or ESC button to exit.

### Setting Programs:

Program	Description	Setting Option	
01	Output source priority: To configure load power source priority	Solar first	SOL 01
		Solar energy provides power to the loads as first priority. If solar energy is not sufficient to power all connected loads, battery energy will supply power the loads at the same time. Utility provides power to the loads only when any one condition happens: - Solar energy is not available - Battery voltage drops to either low-level warning voltage or the setting point in program 12.	
		Utility first (default)	UTI 01
		Utility will provide power to the loads as first priority. Solar and battery energy will provide power to the loads only when utility power is not available.	
		SBU priority	SBU 01
Solar energy provides power to the loads as first priority. If solar energy is not sufficient to power all connected loads, battery energy will supply power to the loads at the same time. Utility provides power to the loads only when battery voltage drops to either low-level warning voltage or the setting point in program 12.			
02	Maximum charging current: To configure total charging current for solar and utility chargers. (Max. charging current = utility charging current + solar charging current)	80 <sup>A</sup>	02
		12KW model: default 80A, 10A~180A Settable 10KW model: default 80A, 10A~160A Settable 8KW model: default 80A, 10A~150A Settable 6KW model: default 80A, 10A~140A Settable 5KW model: default 80A, 10A~130A Settable 4KW model: default 80A, 10A~120A Settable	

03	AC input voltage range	Apl 03	If selected, acceptable AC input voltage range will be within 154~272VAC
		UPS 03	If selected, acceptable AC input voltage range will be within 184~272VAC
05	Battery type	AGM (default) AGM 05	User-Defined
		Flooded FLD 05	If “User-Defined” is selected, battery charge voltage and low DC cut-off voltage can be set up in program 19, 20 and 21.
		Lithium LI 05	S1U1 S1U2 S1U3 Three lithium battery BMS communication protocol options
06	Auto restart when overload occurs	Restart disable (default) LFD 06	Restart enable LFE 06
08	Output voltage	230V 230 <sup>v</sup> 08	220V 220 <sup>v</sup> 08
		240V (default) 240 <sup>v</sup> 08	208V 208 <sup>v</sup> 08
09	Output frequency	50Hz (default) 50 <sup>Hz</sup> 09	60Hz 60 <sup>Hz</sup> 09

11	Maximum utility charging current	<p>30<sup>^</sup> 11</p> <p>12KW model: default 30A, 10A~100A Settable  10KW model: default 30A, 10A~80A Settable  8KW model: default 30A, 10A~70A Settable  6KW model: default 30A, 10A~60A Settable  5KW model: default 30A, 10A~50A Settable  4KW model: default 30A, 10A~40A Settable</p>
12	Setting voltage point back to utility source when selecting "SBU priority" or "Solar first" in program 01	<p>46.0<sup>v</sup> 12</p> <p>48V model: default 46.0V, 44.0V~51.2V Settable</p>
13	Setting voltage point back to battery mode when selecting "SBU priority" or "Solar first" in program 01	<p>54.0<sup>v</sup> 13</p> <p>48V model: default 54.0V, 48.0V~58.0V Settable</p>
14	Charger source priority: To configure charger source priority	<p>If this off grid solar inverter is working in Line, Standby or Fault mode, charger source can be programmed as below:</p>
		<p>Solar first</p> <p>C50 14</p> <p>Solar energy will charge battery as first priority. Utility will charge battery only when solar energy is not available.</p>
		<p>Utility first</p> <p>C0t 14</p> <p>Utility will charge battery as first priority. Solar energy will charge battery only when utility power is not available.</p>
		<p>Solar and Utility</p> <p>SNU 14</p> <p>Solar energy and utility will both charge battery.</p>
		<p>Only Solar</p> <p>O50 14</p> <p>Solar energy will be the only charger source no matter utility is available or not.</p>
		<p>If this off grid solar inverter is working in Battery mode or Power saving mode, only solar energy can charge battery. Solar energy will charge battery if it's available and sufficient.</p>

15	Alarm control	<p>Alarm on (default)</p> <p>60n 15</p>	<p>Alarm off</p> <p>60F 15</p>
16	Backlight control	<p>Backlight on (default)</p> <p>L0n 16</p>	<p>Backlight off</p> <p>L0F 16</p>
17	Beeps while primary source is interrupted	<p>Alarm on (default)</p> <p>A0n 17</p>	<p>Alarm off</p> <p>A0F 17</p>
19	Bulk charging voltage (C.V voltage). If self-defined is selected in program 5, this program can be set up	<p>C<sup>v</sup></p> <p>56.4<sup>v</sup> 19</p> <p>48V model: default 56.4V, 48.0V~58.4V Settable</p>	
20	Floating charging voltage. If self-defined is selected in program 5, this program can be set up	<p>FL<sup>v</sup></p> <p>54.0<sup>v</sup> 20</p> <p>48V model: default 54.0V, 48.0V~58.4V Settable</p>	
21	Low DC cut-off voltage. If self-defined is selected in program 5, this program can be set up	<p>C0<sup>v</sup></p> <p>42.0<sup>v</sup> 21</p> <p>48V model: default 42.0V, 40.0V~48.0V Settable</p>	

## Display Setting

The LCD display information will be switched in turns by pressing "UP" or "DOWN" key. The selectable information is switched as below order: input voltage, input frequency, PV voltage, MPPT charging current, MPPT charging power, battery voltage, output voltage, output frequency, load percentage, load in VA, load in Watt, DC discharging current, main CPU Version and second CPU Version.



Setting Information	LCD display
Input voltage/Output voltage (Default Display Screen)	Input Voltage=230V, output voltage=230V 
Input frequency	Input frequency=50Hz 
AC Charging current	Charging current: 29A 
PV voltage	PV voltage=103V 
PV Charging current	Charging current: 50A 

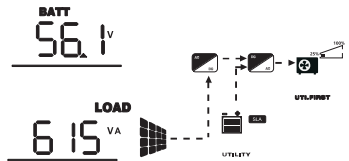
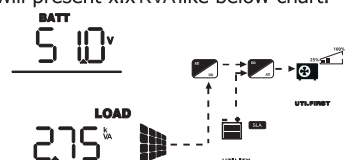
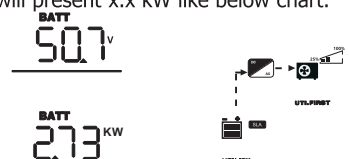
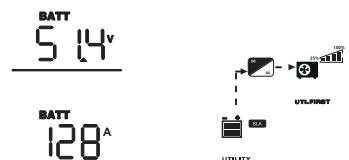
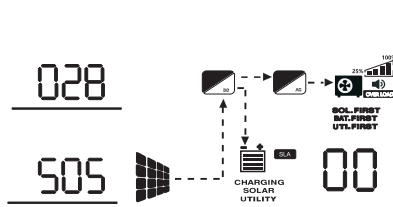

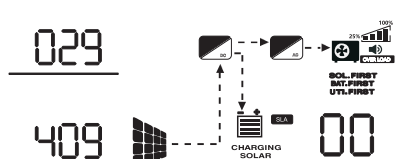
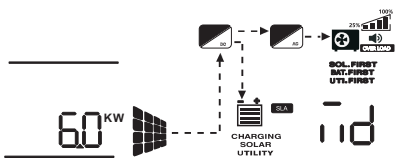
MPPT Charging power	MPPT charging power=1.68KW 
PV and utility Charging current	current=60A  current=140A 
Battery voltage/DC discharging current	Battery voltage=47.5V, discharging current=70A 
Output frequency	Output frequency=50Hz 
Load percentage	Load percent=92% 

Load in VA	<p>When load is lower than 1kW, load in W will present xxx W like below chart.</p>  <p>When load is larger than 1kW (<math>\geq 1\text{KW}</math>), load in W will present x.x kVA like below chart.</p> 
Load in Watt	<p>When load is larger than 1kW (<math>\geq 1\text{KW}</math>), load in W will present x.x kW like below chart.</p> 
DC discharging current	<p>DC discharging current=128A</p> 
Main CPU version checking	<p>CPU version <u>028</u> <u>505</u> 00</p> 

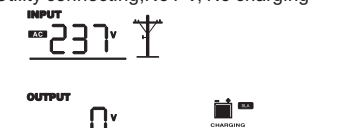
Secondary CPU version checking	<p>Secondary CPU version <u>029</u> <u>409</u> 00</p> 
Inverter rated power	<p>60 kW</p> 



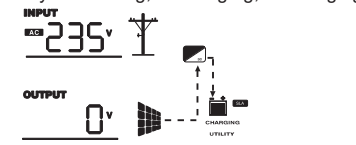
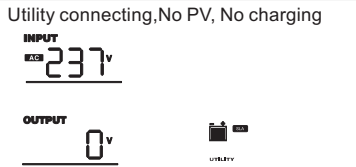
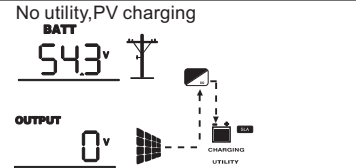

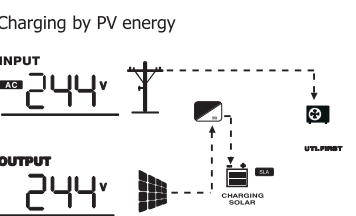
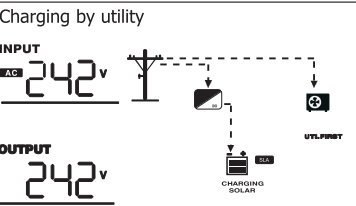

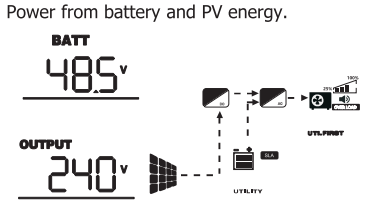
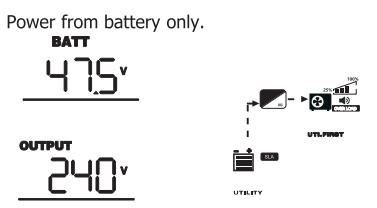

### Operating Mode Description

Operation mode	Description	LCD display
<p>Standby mode / Power saving mode</p> <p><b>Note:</b></p> <p>*Standby mode: The inverter is not turned on yet but at this time, the inverter can charge battery without AC output.</p> <p>*Power saving mode: If enabled, the output of inverter will be off when connected load is pretty low or not detected.</p>	<p>No output is supplied by the unit but it still can charge batteries.</p>	<p>Utility connecting, No charging, PV charging</p> 
		<p>Utility connecting, No PV, No charging</p> 
		<p>No utility, PV charging</p> 
		<p>No charging.</p> 





<p>Fault mode</p> <p>Note:</p> <p>*Fault mode: Errors are caused by inside circuit error or external reasons such as over temperature, output short circuited and so on.</p>	<p>PV energy and utility can charge batteries.</p>	<p>Utility connecting, No charging, PV charging</p> <p>INPUT AC 235v</p> <p>OUTPUT 0v</p> 
		<p>Utility connecting, No PV, No charging</p> <p>INPUT AC 237v</p> <p>OUTPUT 0v</p> 
		<p>No utility, PV charging</p> <p>BATT 54.3v</p> <p>OUTPUT 0v</p> 
		<p>No charging.</p> <p>INPUT AC 236v</p> <p>OUTPUT 0v</p> 
<p>Line Mode</p>	<p>Priority for utility drive the loading solar priority charging</p> <p>INPUT AC 244v</p> <p>OUTPUT 244v</p> 	
	<p>The unit will provide output power from the mains. It will also charge the battery at line mode.</p> <p>INPUT AC 242v</p> <p>OUTPUT 242v</p> 	

<p>Battery Mode</p>	<p>The unit will provide output power from battery and PV power.</p>	<p>Power from battery and PV energy.</p> <p>BATT 48.5v</p> <p>OUTPUT 240v</p> 
		<p>Power from battery only.</p> <p>BATT 47.5v</p> <p>OUTPUT 240v</p> 

### Fault Reference Code

Fault Code	Fault Event	Icon on
01	Fan is locked when inverter is off.	
02	Over temperature	
03	Battery voltage is too high	
04	Battery voltage is too low	
05	Output short circuited or over temperature is detected by internal converter components.	
06	Output voltage is abnormal. Output voltage is too high.	
07	Overload time out	
51	Over current or surge	

## Warning Indicator

Warning Code	Warning Event	Audible Alarm	Icon flashing
10	Battery low voltage	Beep twice every 3 seconds	
11	Overload on bypass	Beep once every second	
12	Solar controller over temperature	Beep once every second	
54	PV input over voltage	Beep once every second	
58	AC output low voltage	Beep once every second	

## Trouble Shooting

Problem	LCD/LED/Buzzer	Explanation / Possible cause	What to do
Unit shuts down automatically during startup process.	LCD/LEDs and buzzer will be active for 3 seconds and then complete off.	The battery voltage is too low (<1.91V/Cell)	1. Re-charge battery. 2. Replace battery.
No response after power on.	No indication.	1. The battery voltage is far too low. (<1.4V/Cell) 2. Battery polarity is connected reversed.	1. Check if batteries and the wiring are connected well. 2. Re-charge battery. 3. Replace battery.
Mains exist but the unit works in battery mode.	Input voltage is displayed as 0 on the LCD and green LED is flashing.	Input protector is tripped	Check if AC breaker is tripped and AC wiring is connected well.
	Green LED is flashing.	Insufficient quality of AC power. (Shore or Generator)	1. Check if AC wires are too thin and/or too long. 2. Check if generator (if applied) is working well or if input voltage range setting is correct. (UPS Appliance)
	Green LED is flashing.	Set "Solar First" as the priority of output source.	Change output source priority to Utility first.
When the unit is turned on, internal relay is switched on and off repeatedly.	LCD display and LEDs are flashing	Battery is disconnected.	Check if battery wires are connected well.
Buzzer beeps continuously and red LED is on.	Fault code 01	Fan fault	Replace the fan.
	Fault code 02	Internal temperature of component is over 100°C.	Check if the air flow of the unit is blocked or the ambient temperature is too high.
	Fault code 03	Battery is over-charged.	Return to repair center.
		The battery voltage is too high.	Check if spec and quantity of batteries are meet requirements.
	Fault code 04	The battery voltage is too low	
	Fault code 05	Output short circuited.	Check if wiring is connected well and remove abnormal load.
	Fault code 06/58	Output abnormal (Inverter voltage below than 180Vac or is higher than 290Vac)	1. Reduce the connected load. 2. Return to repair center
	Fault code 07	Overload error. The inverter is overload 110% and time is up.	Reduce the connected load by switching off some equipment.
Fault code 51	Over current or surge.	Restart the unit, if the error happens again, please return to repair center.	

## Specifications

MODEL	SPF 4000T DVM	SPF 5000T DVM	SPF 6000T DVM	SPF 8000T DVM	SPF 10000T DVM	SPF 12000T DVM
Battery voltage	48VDC	48VDC	48VDC	48VDC	48VDC	48VDC
<b>INVERTER OUTPUT</b>						
Rated Power	4KW	5KW	6KW	8KW	10KW	12KW
Surge Rating (20ms)	12KW	15KW	18KW	24KW	30KW	36KW
Waveform	Pure sine wave/ same as input (bypass mode)					
Nominal Output Voltage RMS	110-115-120Vac / 220-230-240Vac(+/-10% RMS)					
Output Frequency	50Hz/60Hz (+/-0.3 Hz)					
Inverter Efficiency(Peak)	>85%			>88%		
Line Mode Efficiency	>95%					
Power Factor	1.0					
<b>SOLAR CHARGER</b>						
Maximum PV Charge Current	80A			120A		
DC Voltage	48V					
Maximum PV Array Power	5000W			7000W		
MPPT Operating Voltage(VDC)	60-145Vdc					
Max. PV Array Open Circuit Voltage	150Vdc					
Maximum Efficiency	>98%					
<b>DC Input</b>						
Low DC Cut-Off Voltage	@load<20%: 42.0V; @20%≤load<50%: 40.8V; @load≥50%: 38.4V					
Low DC Warning Voltage	@load<20%: 44.0V; @20%≤load<50%: 42.8V; @load≥50%: 40.4V					
Low DC Warning Return Voltage	@load<20%: 46.0V; @20%≤load<50%: 44.8V; @load≥50%: 42.4V					
High DC Recovery Voltage	58VDC					
High DC Cut-Off Voltage	AGM:60V, FLD:62V, USE Mode: C.V. Voltage + 4.0V					
<b>AC INPUT</b>						
Voltage	230VAC					
Selectable Voltage Range	154~272VAC (for appliances) / 184~272VAC (for UPS)					
Frequency Range	50Hz/60Hz (Auto sensing)					
Maximum Charge Current	40A	50A	60A	70A	80A	100A
<b>BYPASS &amp; PROTECTION ( Grid &amp; Generator )</b>						
Typical Transfer Time	10ms					
Overload Protection (SMPS Load)	Circuit breaker					
Output Short Circuit Protection	Circuit breaker					
<b>MECHANICAL SPECIFICATIONS</b>						
Dimensions (W*H*D)	540*360*218mm			650*380*225mm		
Net Weight (Solar CHG) kg	38	41	45	64	66	75
<b>OPERATING ENVIRONMENT</b>						
Operation Temperature Range	0°C to 40°C					
Storage Temperature	-15°C to 60°C					