

CN/EN-A01

Creator 3 Pro 金刚狼3 Pro

# 用户使用手册

USER GUIDE

中文P30



This guide is only applicable to FLASHFORGE Creator 3 Pro 3D printer

本手册仅适用于闪铸科技 金刚狼3 Pro 3D打印机

## PREFACE

**Note:** Every 3D printer has undergone printing test before leaving factory. If there are some residues in the extruder of the equipment or some slight scratches on the build plate, it is normal and will not affect its use.

Dear Flashforge users, thank you for choosing Flashforge products. Thank you for your great support and help for Flashforge. Please read this guide carefully before use and follow the instructions strictly. The whole Flashforge team will provide you with superior service. No matter what problems you encounter during use, please contact us according to the phone number and email address provided at the end of the guide.

In order for you to better experience our products, you can also acquire skills about the equipment operation from the following sources.

### (1) User Guide:

Please unpack the box carefully. Then you can take out the attached documents from the top foam or browse the latest user guide from the USB disk. This will help you familiarize yourself with the equipment and successfully complete your first printing.

### (2) Official Flashforge Website:

Flashforge Chinese website: [www.sz3dp.com](http://www.sz3dp.com)

Flashforge English website: [www.flashforge.com](http://www.flashforge.com)

You can visit the Flashforge official website to obtain information about related software and hardware, contact information, equipment operation, equipment maintenance and other related information.

## NOTICE

**PLEASE STRICTLY FOLLOW ALL THE SAFETY WARNINGS AND NOTICES BELOW ALL THE TIME.**

### WORK ENVIRONMENT SAFETY

- ◆ Keep Creator 3 Pro's work table clean and tidy.
- ◆ Do not operate Creator 3 Pro in the presence of flammable liquids, gases or dust. (The high temperature generated by equipment operation may react with airborne dust, liquids, and combustible gases and cause fire.)
- ◆ Keep Creator 3 Pro out of children and untrained persons' reach.

### ELECTRICAL SAFETY

- ◆ Make sure to use Creator 3 Pro with a properly grounded outlet. Do not refit Creator 3 Pro's plug. (Ungrounded/improperly grounded/modified plug will inevitably increase the risk of electric leakage.)
- ◆ Do not expose Creator 3 Pro to damp or hot-sun environment. (Humidity will increase the risk of electric leakage./Exposure to sunlight will accelerate the aging of plastic parts.)
- ◆ Make sure to only use the power supply provided by Flashforge.
- ◆ Do not use Creator 3 Pro during a thunderstorm.
- ◆ Please shut down Creator 3 Pro and unplug it if it is not in use for a long time.

### PERSONAL SAFETY

- ◆ Do not touch the extruder and build plate, etc during printing.
- ◆ Do not touch the extruder when finishing printing.
- ◆ Dress properly. Do not wear scarves, masks, gloves, jewelry ornaments or other objects that can easily get caught in the equipment when operating it.
- ◆ Do not operate Creator 3 Pro while you are tired or under the influence of drugs, alcohol or medication.

## CAUTIONS

- ◆ Do not leave the running equipment for a long time.
- ◆ Do not make any modifications to the equipment.
- ◆ Please keep the distance between the extruder and the build plate for at least 50mm during filament loading operation. (Too-close distance may cause extruder blockage.)
- ◆ Operate the equipment in a well-ventilated environment.
- ◆ Do not use the equipment for illegal activities.
- ◆ Do not use the equipment to make any food storage products.
- ◆ Do not use the equipment to make any electrical appliances.
- ◆ Do not put the printed model into your mouth.
- ◆ Do not remove the printed models with brute force.
- ◆ Do not connect the equipment with the network cable longer than 3m.

## ENVIRONMENT REQUIREMENTS

- ◆ Temperature: RT 15-30°C
- ◆ Humidity: 20%-70%

## EQUIPMENT PLACING REQUIREMENTS

- ◆ The equipment must be placed in a dry and ventilated environment. The distances of the left, right and rear side space of the equipment should be at least 20cm, and the distance of the front side space should be at least 35cm.

## COMPATIBLE FILAMENT REQUIREMENTS

- ◆ When using the equipment, please use Flashforge filaments or other filaments provided or specified by Flashforge. There is a wide variety of filaments on the market with varying quality. Poor quality or incompatible filaments can easily cause extruder blockage and extruder damage.

## FILAMENT STORAGE REQUIREMENTS

- ◆ Do not unpack the filament until it is needed for use. Please store the filament in a dry and dust-free environment after unpacking.

## LEGAL NOTICE

- ◆ Do not copy or print any items prohibited by law.
- ◆ According to local laws, it is generally illegal to copy or print the following items:
  1. Gun
  2. Copy works protected by the copyright. Some copyrighted works may be allowed to be partially copied for "fair use". Multiple copies will be regarded as improper use. Artistic works are equivalent to copyrighted works.
- ◆ The above list is for reference only and does not include all contents. Flashforge shall not be liable for its completeness or accuracy. If you have questions regarding the legality of copying or printing certain items, please consult the legal counsel.

## LEGAL STATEMENT

- ◆ The user has no right to make any modification to this user guide.
- ◆ Flashforge will not be responsible for any safety accidents caused by disassembly or modification of the equipment by the customer. No one is allowed to modify or translate this guide without the permission of Flashforge.
- ◆ This guide is protected by copyright, and Flashforge reserves the right of final interpretation of this guide.
- ◆ Flashforge reserves the right to modify the guide due to subsequent equipment upgrades.
  
- ◆ First Edition (July 2021)  
©Copyright 2021 Zhejiang Flashforge 3D Technology Co., Ltd. All Rights Reserved.

## SERVICE

- ◆ Unplug the Creator 3 Pro before performing any service procedures. Failure to do so may result in personal injury and equipment damage. Only filaments and components approved by Flashforge can be used, otherwise the warranty may be invalid.



# CONTENT

<b>Equipment Parameter</b>	<b>05</b>
<b>1. Equipment Introduction</b>	<b>06</b>
1.1 - Creator 3 Pro Introduction	06
1.2 - Packing List	07
1.3 - Precautions for Unpacking the Equipment	08
<b>2. Preparation for Printing</b>	<b>09</b>
2.1 - Filament Loading	09
2.2 - Leveling and Calibration	12
2.3 - Internet Connection	13
<b>3. FlashPrint Installation</b>	<b>14</b>
<b>4. First Printing</b>	<b>14</b>
4.1 - File Transfer: Wi-Fi transfer	14
4.2 - Printing via USB Disk	15
4.3 - Printing via FlashCloud	15
4.4 - Model Removal	15
<b>5. Equipment Configuration and Operation</b>	<b>16</b>
5.1 - Dual-extruder Printing Mode Setting	16
5.2 - Mirror/Duplicate Mode	17
5.3 - Filament Configuration	19
5.4 - Filament Setting	19
5.5 - Removal Method of Water-soluble Support Filament	20
5.6 - Camera Connection	21
<b>6. Equipment Operation Interface Introduction</b>	<b>22</b>
6.1 - Printing Screen	22
6.2 - Tools Screen	24
6.3 - Setting Screen	25
<b>7. Maintenance</b>	<b>26</b>
7.1 - Copy the Log	26
7.2 - Maintenance and Service	26
7.3 - Unclog the Nozzle	27
7.4 - Replace the Nozzle Assembly	27
7.5 - Anti-oozing Plate	28
7.6 - Daily Maintenance and Use Suggestion	28
<b>8. Support and Service</b>	<b>29</b>

## Equipment Parameter

Printer Name	Creator 3 Pro
Number of Extruder	2, independent
Printing Technology	Fused Filament Fabrication(FFF)
Touch Screen	4.3-inch color IPS Touch Screen
Build Volume	300×250×200mm
Layer Height	0.05 - 0.4mm
Printing Accuracy	±0.2mm
Positioning Accuracy	Z axis: 0.0025mm; XY axis: 0.011mm
Printing Filament	PLA/ABS/PETG/PA/PC/HIPS/ASA/PLA-CF/ PETG-CF/PACF/WOOD filament
Filament Diameter	1.75mm (±0.07mm)
Extruder Diameter	0.4mm
Printing Speed	10~150 mm/s
Software	FlashPrint
Supported Format	Input: 3MF/STL/OBJ/FPP/BMP/PNG/JPG/JPEG Output: GX/G
Operation System	Win XP/Vista/7/8/10、 Mac OS、 Linux
Printer Size	627×485×615mm
Net Weight	40Kg
Connectivity	USB Stick, Wi-Fi, Ethernet

# 1. Equipment Introduction

## 1.1 Creator 3 Pro Introduction

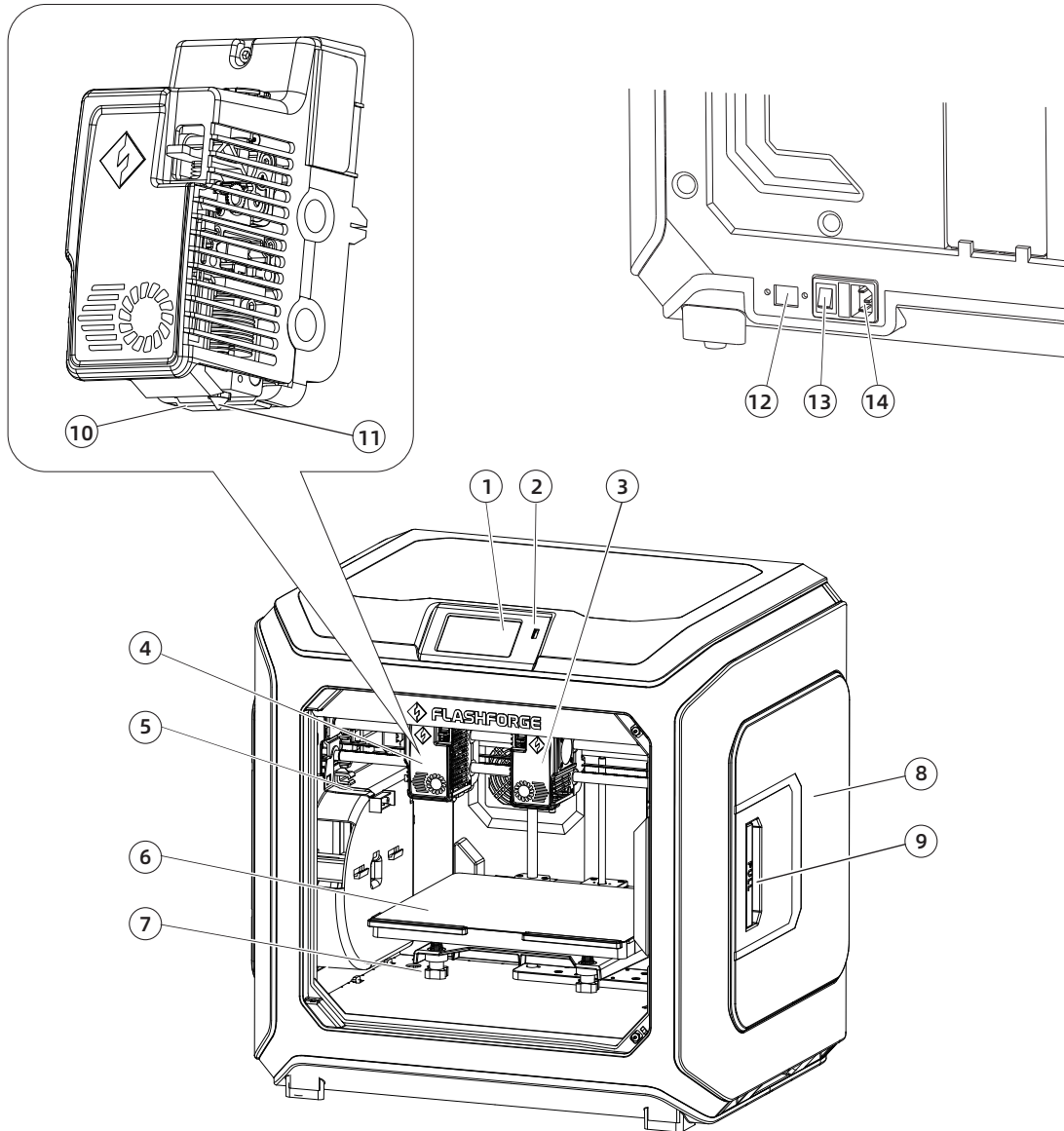

- |                   |                                |                                 |                      |
|-------------------|--------------------------------|---------------------------------|----------------------|
| 1. Touch screen   | 5. The anti-oozing metal plate | 9. Filament holder cover handle | 13. Power switch     |
| 2. USB disk port  | 6. Build plate                 | 10. Wind guide nozzle           | 14. Power cord entry |
| 3. Right extruder | 7. Leveling nut                | 11. Nozzle                      |                      |
| 4. Left extruder  | 8. Filament holder cover       | 12. Ethernet port               |                      |

## 1.2 Packing List

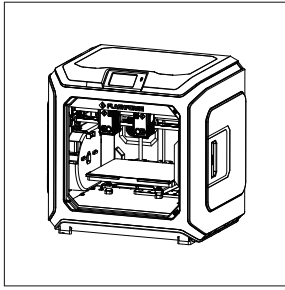

Creator 3 Pro

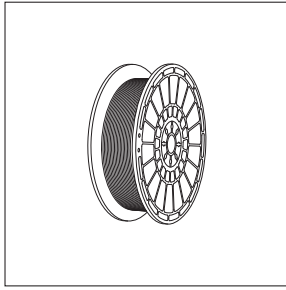

Filament

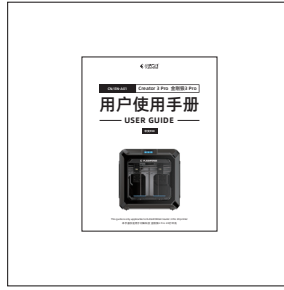

User Guide



After-sales service card

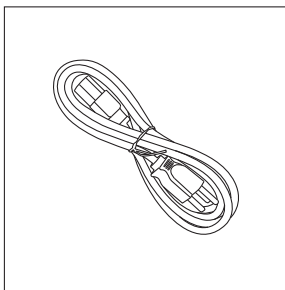

Power cord

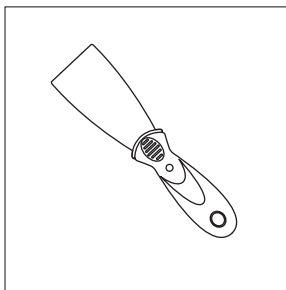

Scraper

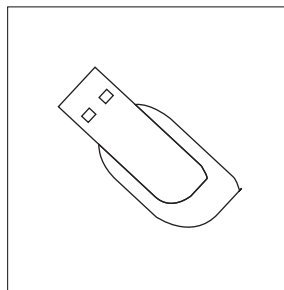

USB disk

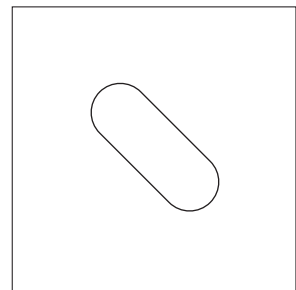

Leveling card

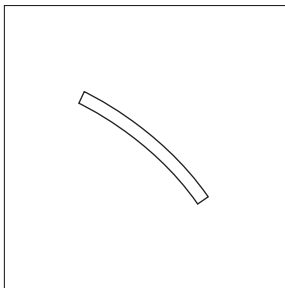

PTFE tube

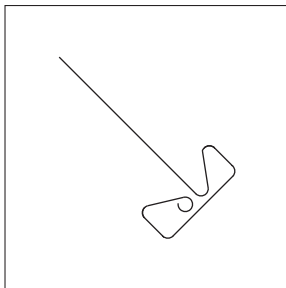

Unclogging pin tool

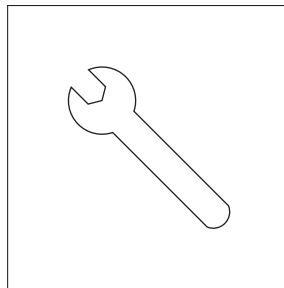

Stamping wrench

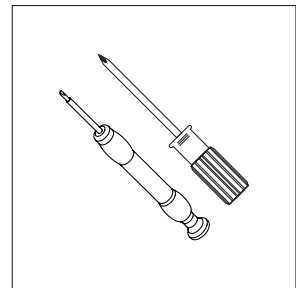

Screwdriver

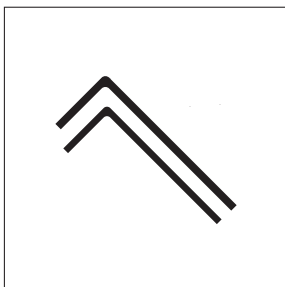

Allen wrench

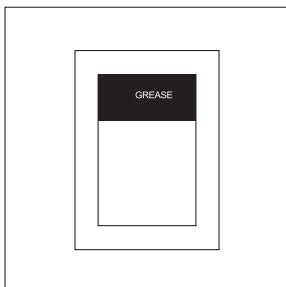

Lubricating grease

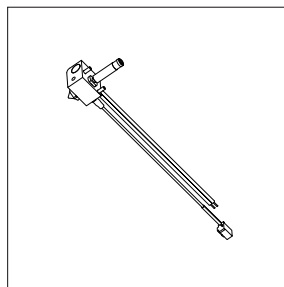

Nozzle kit

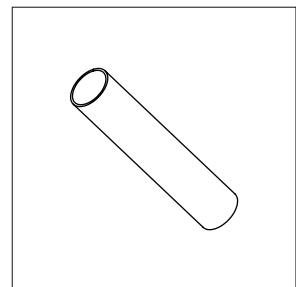

Nozzle support tube

## 1.3 Precautions for Unpacking the Equipment

1. Take out the top accessories and pearl cotton.
2. Remove the tape from the machine.
3. Take out the internal pearl cotton block.

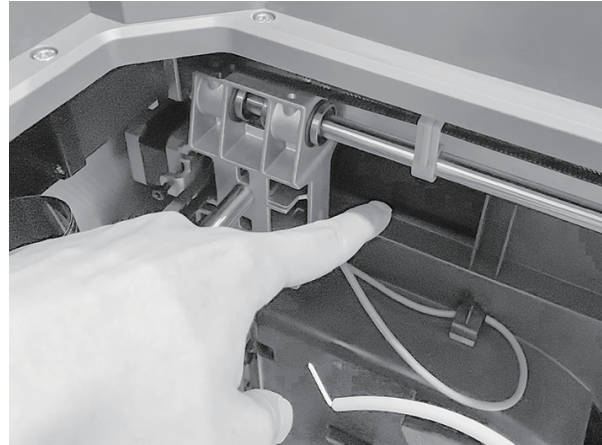
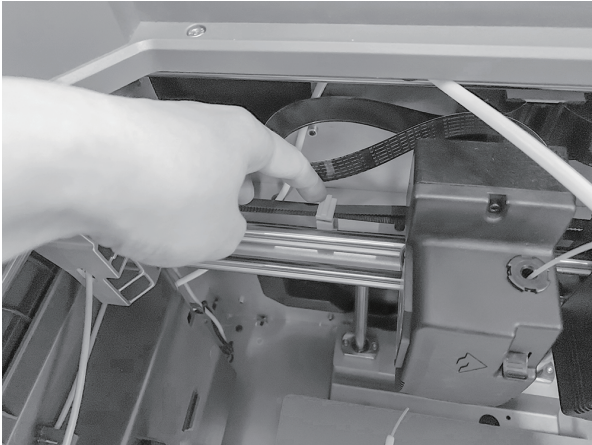

4. Remove the buckles on the X-axis and Y-axis synchronous belts.

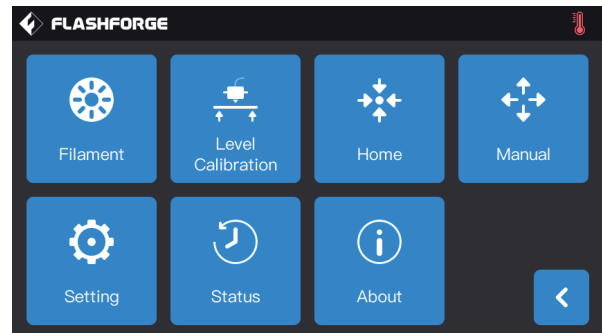
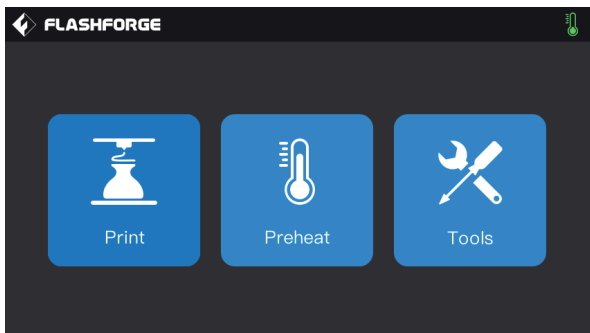

5. Connect the printer to the power supply, after power on, and then click [Tools] and [Manual] in turn on the touch screen to enter the manual control interface.

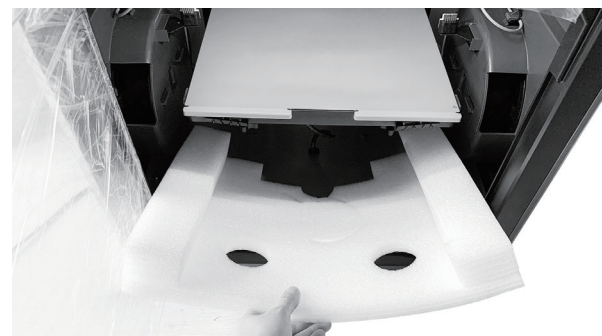
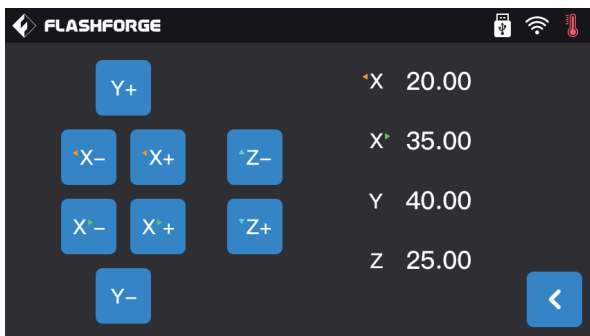

6. Press and hold [Z-] continuously until the build plate rises to a higher position, and then take out the foam block below.

## 2. Preparation for Printing

### 2.1 Filament Loading

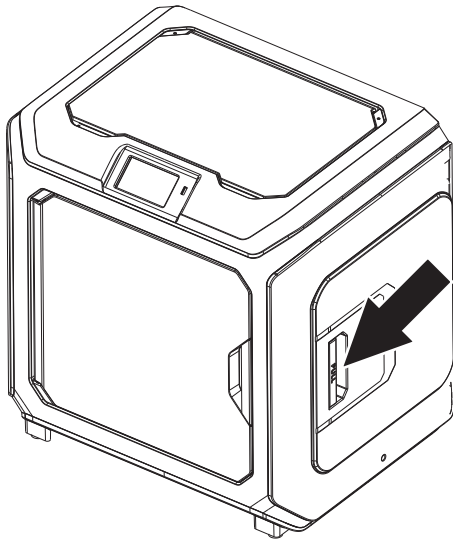

1. Open the filament holder cover.

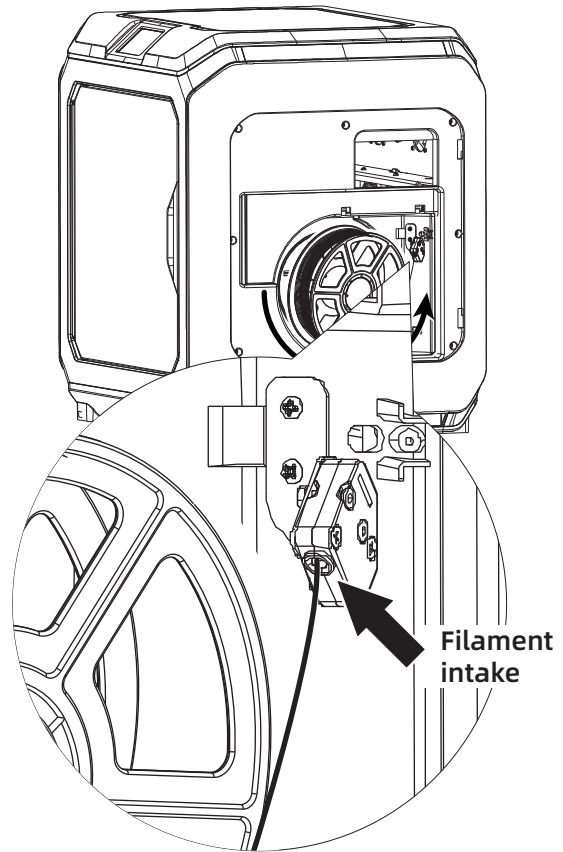

2. Take out the filament and insert it into the filament feeding inlet.

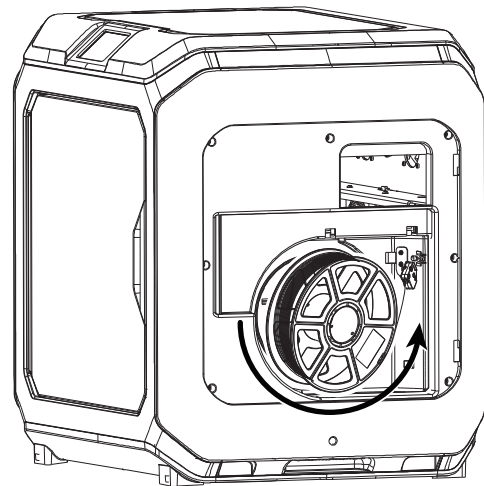
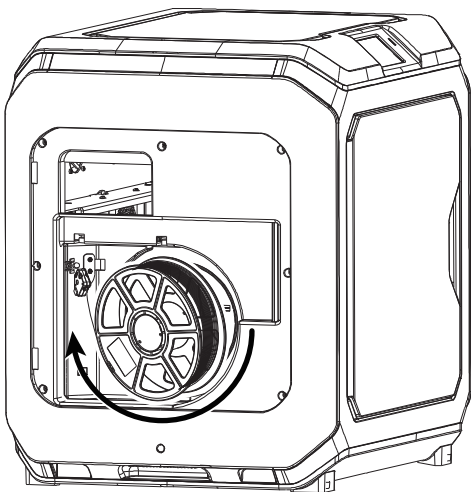

3. Attention: To facilitate smooth rotation of the filament, please install the filament in the direction shown in the figure.

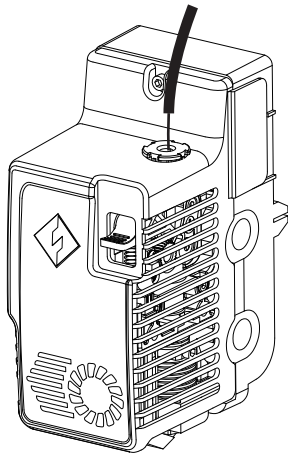

4. Insert the filament into the filament feeding inlet continuously until the filament goes through the filament guide tube.

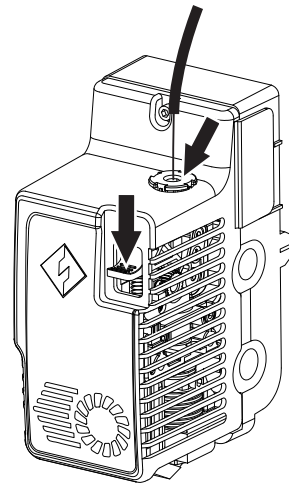

5. Press the filament feeding pressing plate in front of the extruder, insert the filament vertically into the extruder until it can't be inserted any further, and then loosen the filament feeding pressing plate.

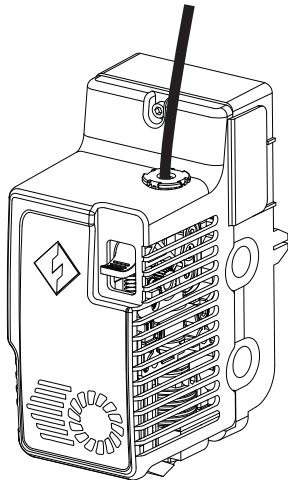

6. Insert the filament guide tube into the filament inlet hole on the extruder to fix.

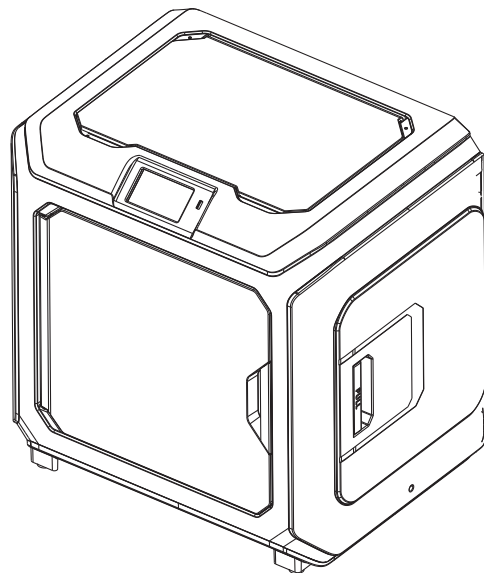

7. Finally, fix the filament spool on the filament spool holder and close the cover.

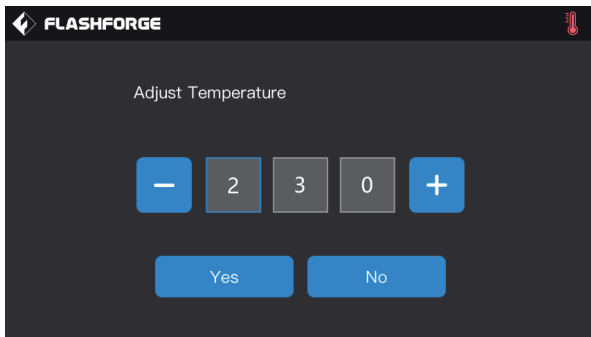
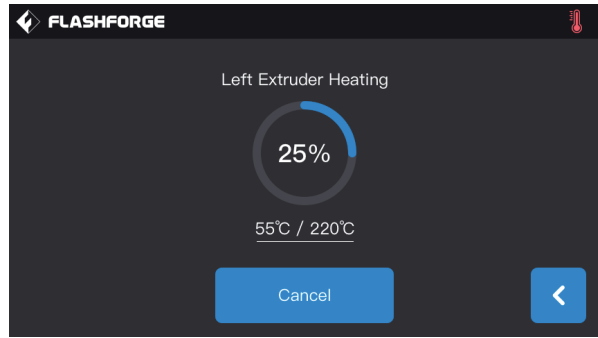
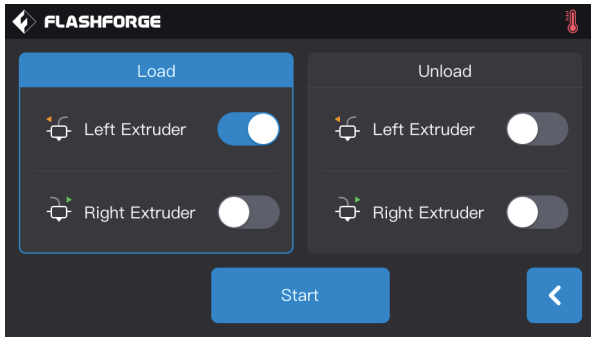
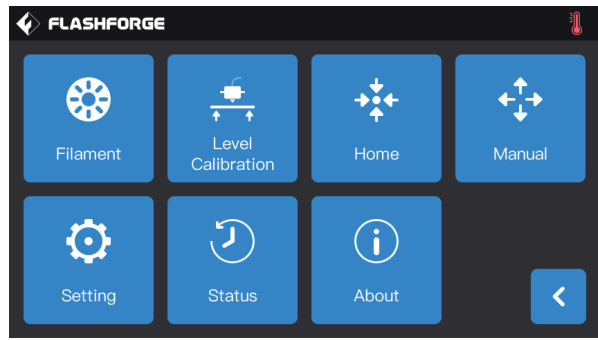
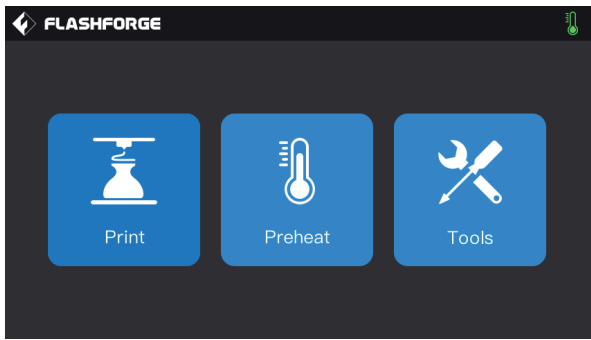

8. Filament feeding operation: Click the [Tools]-[Filament] button on the screen in turn, and set a reasonable heating temperature according to the required temperature value of the material; Operate according to the screen prompts, and wait for the nozzle to extrude uniform filament smoothly.

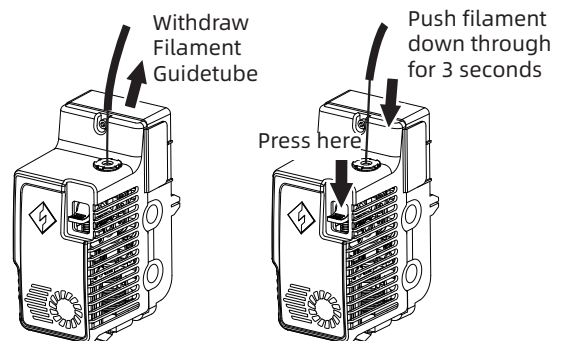
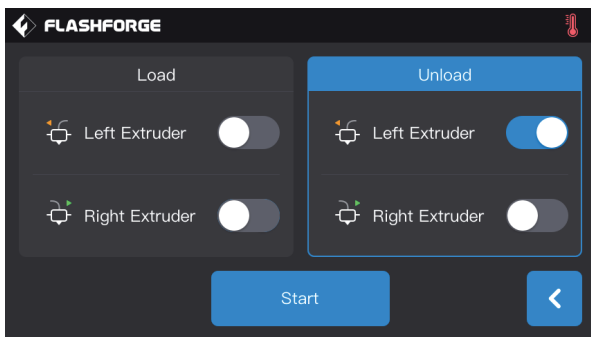

Filament unloading operation: Click [Unload], press down the filament pressing plate after the extruder temperature heating is completed, pull out the white filament guide tube, and pull out the filament upward quickly and then filament unloading is completed.



## 2.2 Leveling and Calibration

The equipment has been leveled and calibrated before leaving factory. However, the leveling plane may be damaged due to the vibration generated during transportation. It is recommended to perform leveling before the first printing. There are two leveling modes: auxiliary leveling mode and manual leveling mode. In the auxiliary leveling mode, all execution will be completed with the help of the extruder sensor and auxiliary prompts. When the function option is in the manual mode, the platform leveling in the auxiliary mode will not activate the sensor function.

In total, the equipment contains the following leveling calibrations: Platform Leveling, Calibration XY, Calibration Z and Auto level;

Please operate in the following order:

1. Click [Tools] and [Level Calibration] on the touch screen;
2. Select the auxiliary mode for leveling and calibration;
3. The extruder sensor calibration has been set before leaving factory, so there is no need to operate again; Click platform leveling and operate following the prompts on the screen.
4. Perform Z-axis calibration and operate following the prompts on the screen;
5. The X, Y axis have been calibrated before leaving factory, so there is no need to operate again;
6. The whole leveling and calibration is completed.

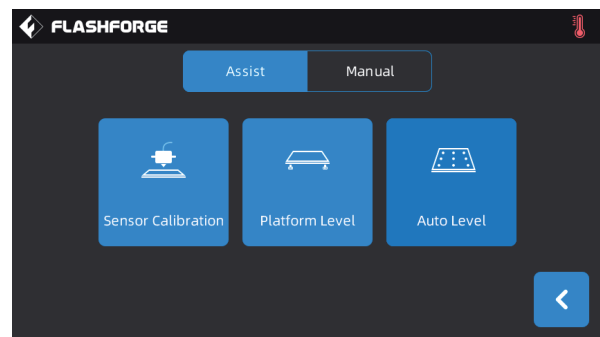
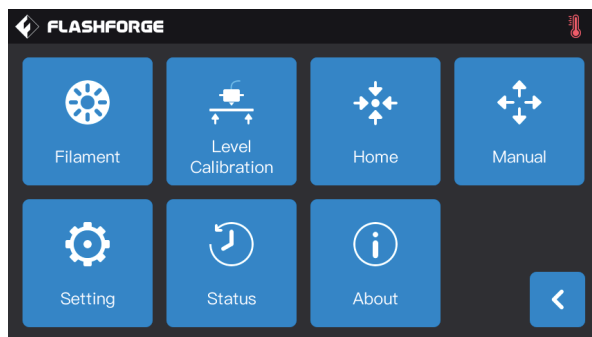

9-point leveling function: when the printing flatness is still poor after the platform leveling and XY/Z axis calibration, this function can be used to compensate for better flatness;

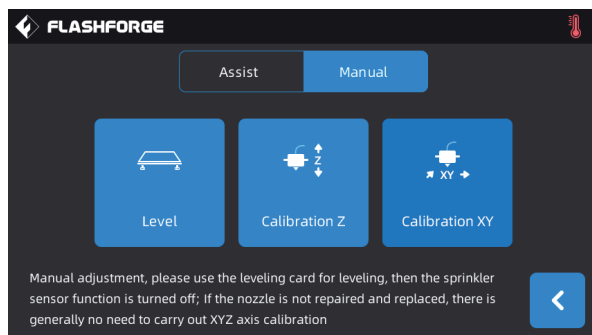

Manual leveling mode: Execute platform leveling, Z-axis calibration and X, Y axis calibration in turn. This is a complete set of leveling and calibration operation procedures.

## 2.3 Internet Connection

### • Wired network connection

Plug the network cable into the equipment's network port, and an icon  appears in the upper right corner of the screen, indicating that the equipment is successfully connected to the network.

### • WLAN network connection

Click [Tools]-[Setting]-[WiFi] on the main interface of the touch screen of the equipment, turn on the WLAN and select the network to be connected. The icon  appears in the upper right corner of the screen, indicating that the equipment is successfully connected to the network.

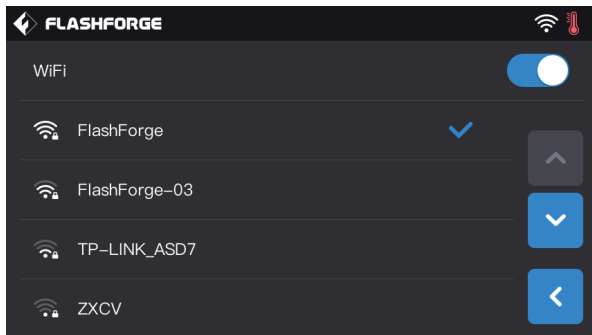

### • WLAN hotspot connection

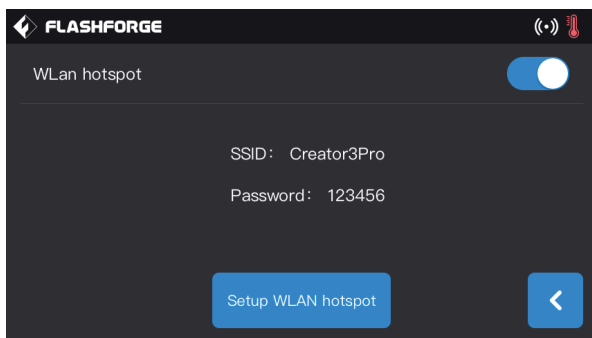

1. Click [Tools]-[Setting]-[Wlan hotspot] on the main interface of the touch screen of the equipment, turn on the hotspot of the equipment. You can freely set the name and password of the hotspot. The icon  appears in the upper right corner of the screen, indicating that the device has successfully turned on the hotspot.



2. Search for the hotspot you set with your laptop, connect it, and enter the password.

**Note:** If you have more than one Creator 3 Pro at the same time, please go to the WLAN hotspot setting to modify the hotspot names separately.

# 3. FlashPrint Installation

**Method 1:** Find the FlashPrint software installation package in the USB disk and select the corresponding system version for installation.

**Method 2:** Download the latest slicing software from the official Chinese website ([www.sz3dp.com](http://www.sz3dp.com)) or the official English website ([www.flashforge.com](http://www.flashforge.com)) for installation.

**3D printing process:**

Get the model file - Slice with the slicing software - Transfer the file to the printer for printing.

# 4. First Printing

## 4.1 File Transfer: Wi-Fi transfer

Import the STL or OBJ file to FlashPrint for slicing, select Creator 3 Pro to connect to the machine (or by entering the IP address or by auto-scanning, while the IP address can be viewed in Device [About]). Then it will be sent directly to the printer after slicing is completed.

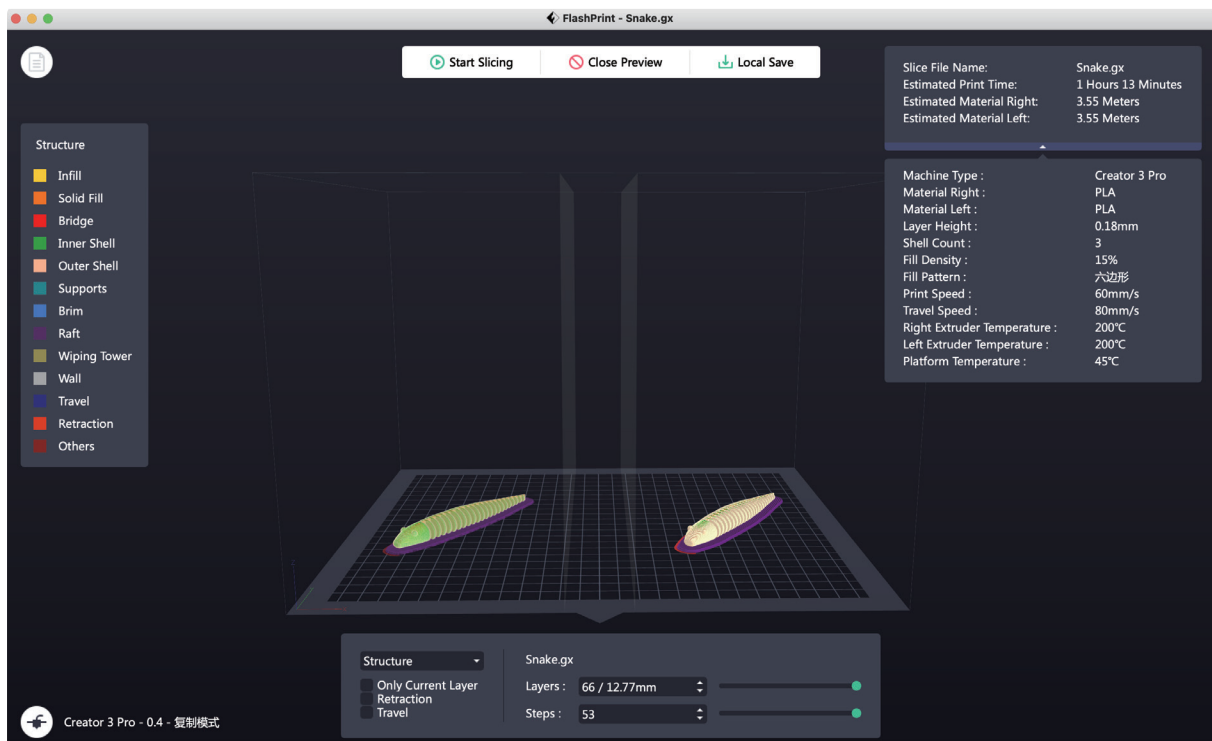

## 4.2 Printing via USB Disk

The equipment can perform printing via USB disk: save the sliced file to the USB disk, insert the USB disk into the equipment, and select the corresponding file to print.

## 4.3 Printing via FlashCloud

1. Enter the FlashCloud website, register your account, and then you can log in and use it after the email activation.

FlashCloud: <https://cloud.sz3dp.com>

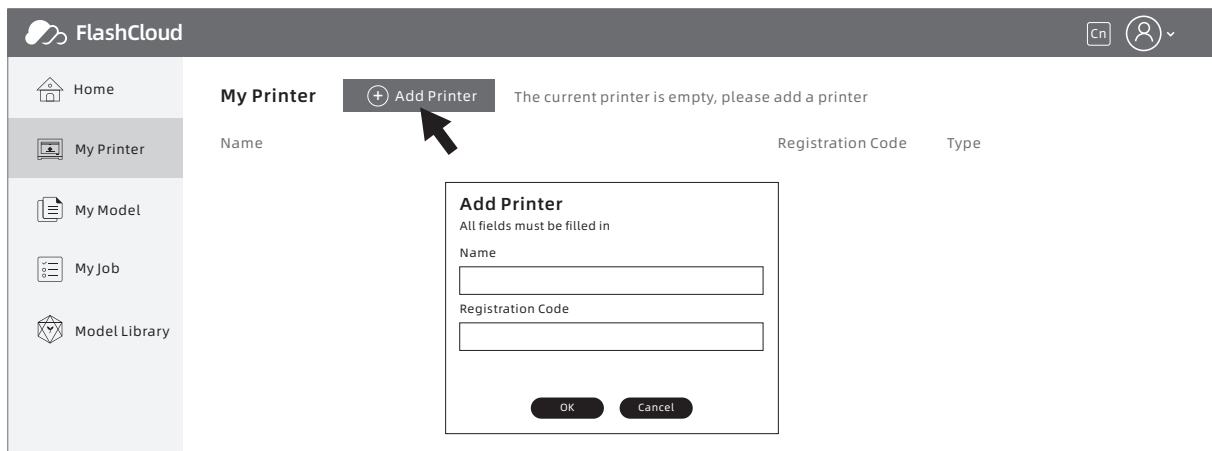

2. Click [My Printer] - [Add Printer].

Fill in the registration number (cloud registration code) on the Add Printer page, and name the printer. After clicking OK, these information will appear in the FlashCloud interface of the printer.

## 4.4 Model Removal



### Note

**Notice:** Wait for the platform to cool down before operating.

**Warning:** Please be careful when removing the model from the build plate with hand tools. Sudden tool slippage and improper body position when removing the model from the build plate may result in personal injury.

**Attention:** Do not scratch the build plate when removing the model. Scratches in the build plate will lead to model creation errors.

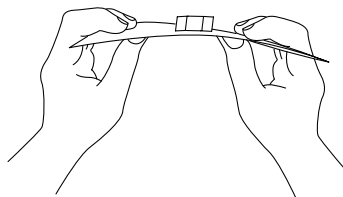

Remove the magnetic steel plate and bend it and the model can be removed.

# 5. Equipment Configuration and Operation

## 5.1 Dual-extruder Printing Mode Setting

When printing dual-color/dual-filament models in the dual-extruder printing mode, please make sure the nozzles are in contact with the anti-oozing plate. This will prevent the nozzles from overflowing during the printing process.

Creator 3 Pro defaults to the left extruder as the filament supporting extruder and the right extruder as the printing extruder. When printing a single-color model, the right extruder is automatically used as the printing extruder if not set by the user. The following modes can be set for printing:

In the expert mode:

1. Load the model;
2. Select the support type, and click  ;
3. Add the support automatically, and click [Supports] > [Auto Supports];
4. Click [Start Slicing], entering the parameter configuration screen;
5. Select the configured filament, such as Creator 3 Pro PLA + PVA;
6. Click [Slice].

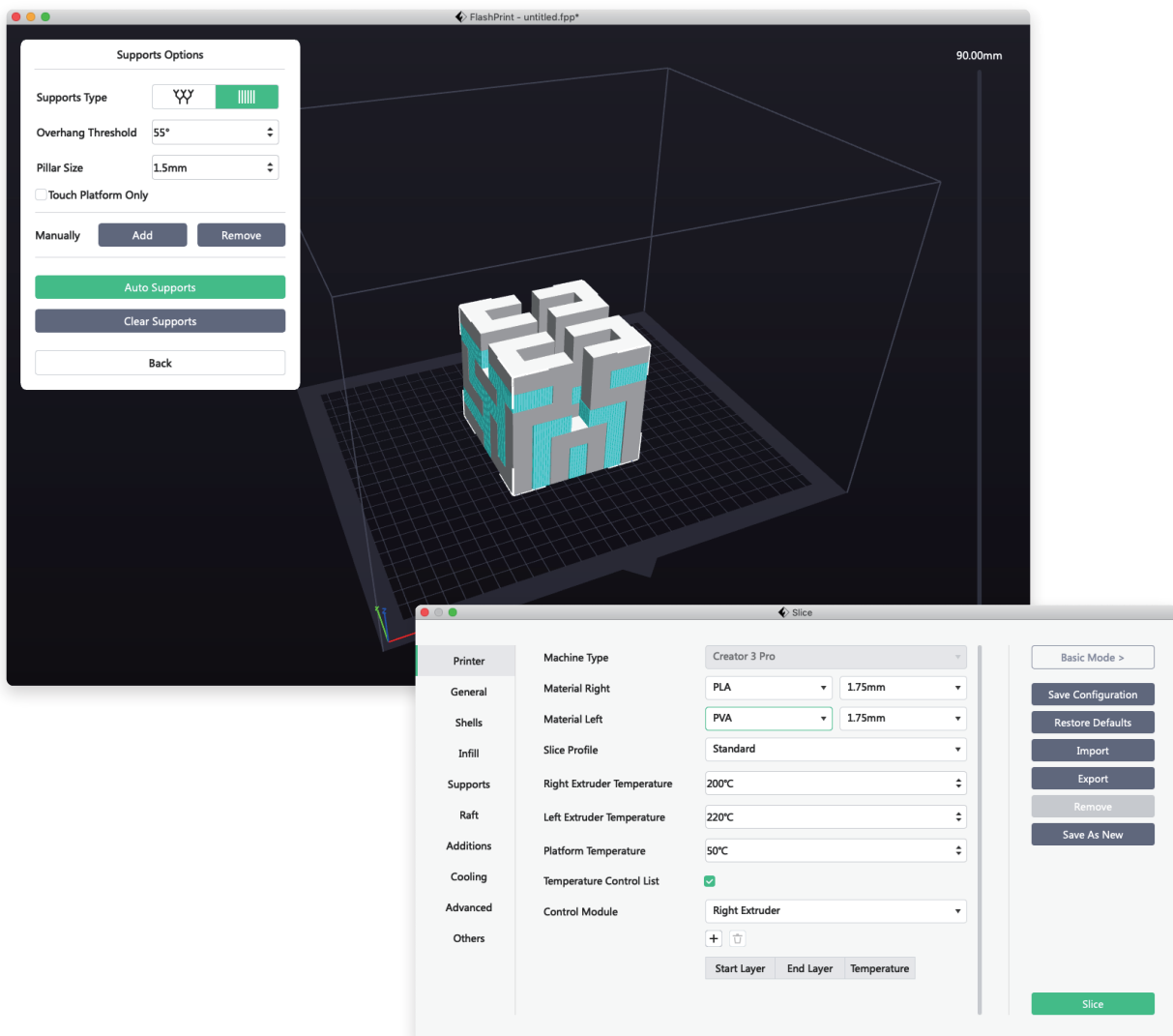

## 5.2 Mirror/Duplicate Mode

If you want to print two identical or mirror models, please choose the mirror/duplicate mode. In this mode, the left and right extruders will print the models at the same time. (Note that when in the mirror/duplicate mode, the X-axis size of the model only supports the models smaller than 133mm.)

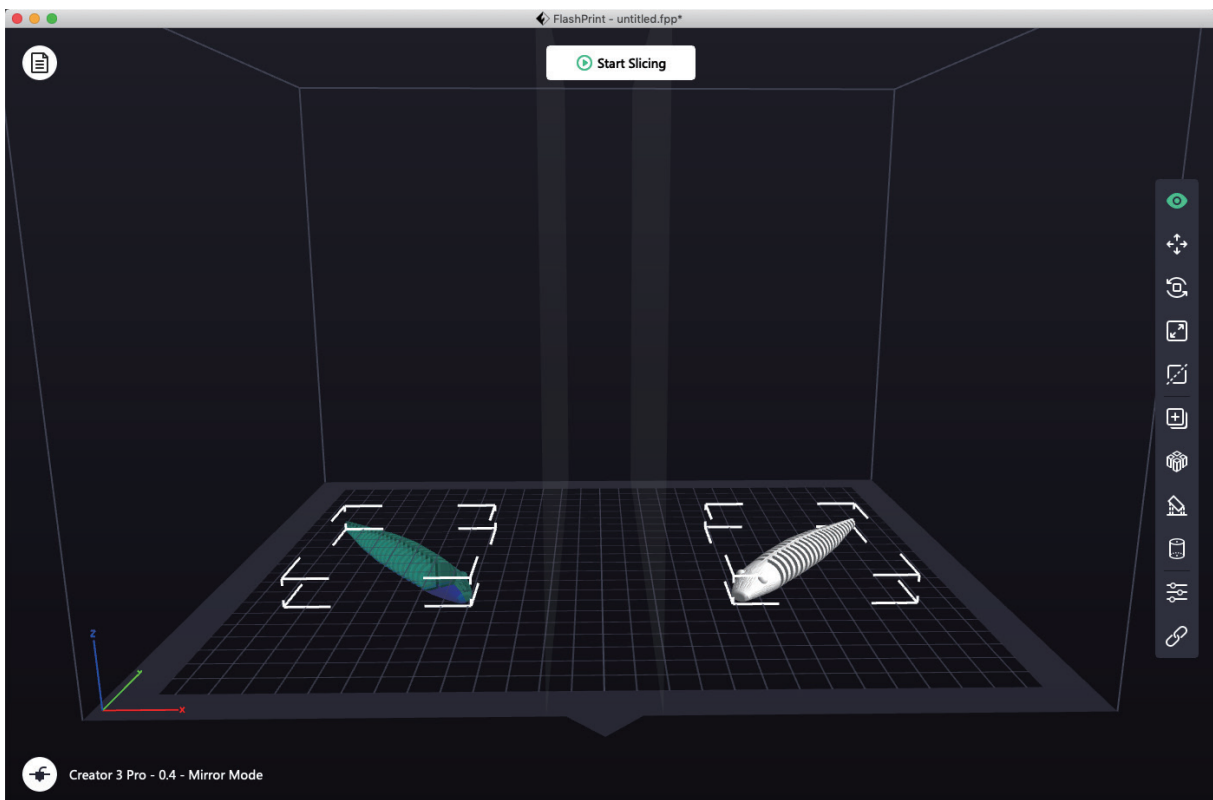
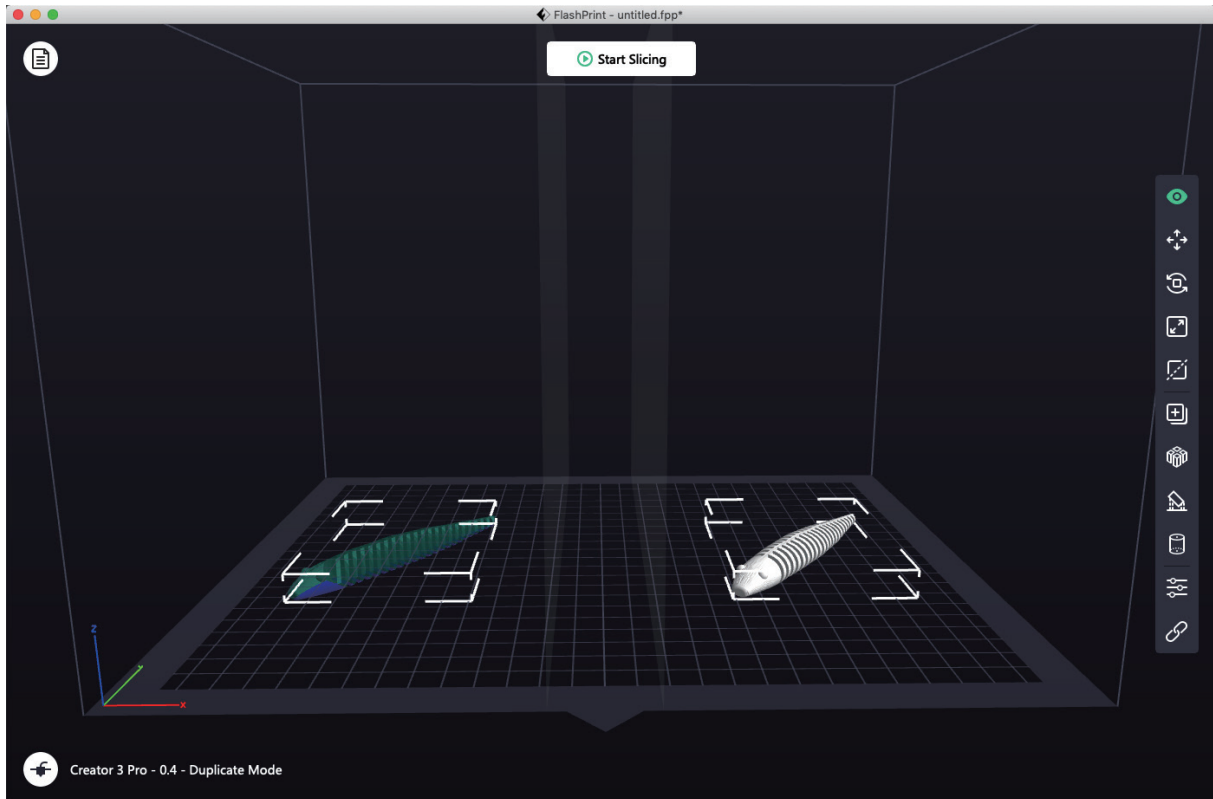

## Compensation layer in the mirror/duplicate mode

**Mirror/duplicate mode:** Since the heights of the left and right extruders are different after installation, the software will automatically add a compensation layer to compensate for the height difference when slicing, so that the printing heights of the left and right sides are consistent. Z-axis calibration is based on the right extruder, and the height difference between the left and right extruders is recorded.

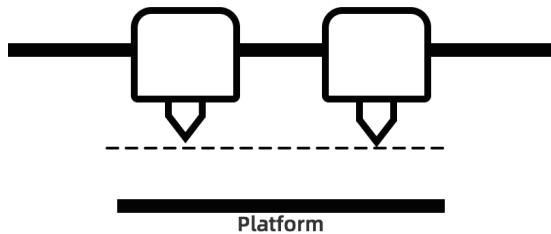

When the distance between the right extruder and the platform is small, the left extruder prints the compensation layer.

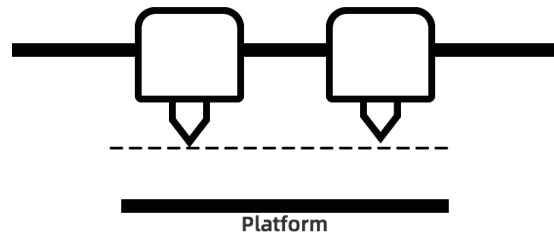

When the distance between the left extruder and the platform is small, the right extruder prints the compensation layer.

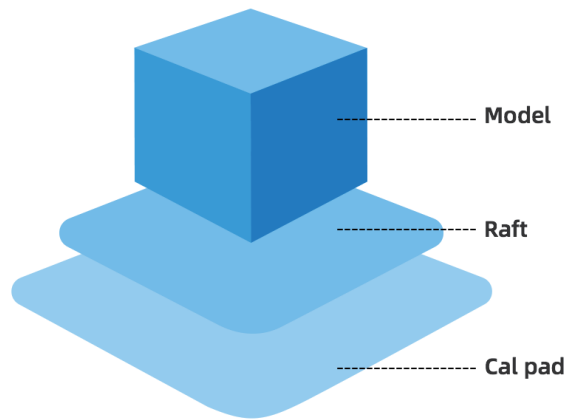
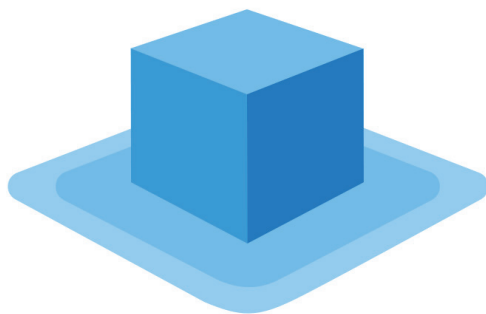

When the height difference is less than 0.2mm, the compensation layer is not printed.

The compensation layer is printed first, and it is easy to be removed by adhering to the raft. If the raft printing is not performed, the compensation layer will be directly applied to the model, which is difficult to remove.

## 5.3 Filament Configuration

Creator 3 Pro is equipped with two independent extruders. It can be used for printing PLA, ABS, PETG, Nylon, PC, HIPS and PVA filaments. Creator 3 Pro's left extruder print support filaments by default.

Please refer to the table below for the combination of independent dual-extruder extrusion filaments.

### Soluble filament combination:

Left extruder	Right extruder
PVA	PLA
PVA	NYLON
HIPS	ABS
HIPS	ASA
HIPS	PC
HIPS	PETG
HIPS	HIPS

PVA: Soluble in water;

HIPS: Soluble in limonene.

### Insoluble filament combination:

Left extruder	Right extruder
PLA	PLA
ABS	ABS
ASA	ASA
PC	PC
PA	PA
PETG	PETG
PA-CF	PA-CF
PA-GF	PA-GF

**Note:** Creator 3 Pro can print nylon carbon fiber and nylon glass fiber. However, because the nozzle is not made of high-strength material, it will cause wear on the nozzle. Therefore it is estimated that the nozzle needs to be replaced when printing one roll of 1kg nylon carbon fiber filaments. This situation can be switched to high-strength nozzle printing.

### Storage of PVA/PA filaments

PVA filaments are water-soluble and have strong water absorption. Filaments will soften when absorbing water, which will easily lead to printing failure. PVA filaments should be placed in a drying box when printing. PA/PVA storage needs to be sealed and dried.

## 5.4 Filament Setting

For best results, each filament requires different settings.

If a model is prepared using FlashPrint, these settings will automatically be set correctly if the correct extruder and filament are selected.

### Adaptability of filament parameters

Different filament brands correspond to different filament characteristics, so it is recommended to use the expert mode to fine-tune the parameters to ensure better printing quality when using Creator 3 Pro.

- Thickening the first layer height, and increasing the amount of the first layer filament output is conducive to the adhesion of the first layer;
- Please set the raft temperature at 45°C when printing small models with PLA (or ambient temperature is higher than 25°C);
- Please set the raft temperature at 70°C when printing large models with PLA (or ambient temperature is lower than 10°C);
- When using PVA support, it is recommended that the support speed be reduced to 40%.

For all materials supported by Creator 3 Pro, it is recommended to apply a thin layer of glue (using the glue stick in the accessory box) on the build plate before starting printing, which will ensure that the finished printing work adheres well to the build plate.



## 5.5 Removal Method of Water-soluble Support Filament

Models using PVA as the support filament require some subsequent treatment to remove the PVA support filament. This can be done by dissolving the PVA in water.

### 1. Soak the model in water

The PVA model can be dissolved slowly by putting it into water. You can use the following methods to speed up the dissolution process:

- Using hotter water can reduce the dissolution time. If the construction material is PLA, please make sure that the maximum temperature of the water does not exceed 35°C to avoid PLA deformation. If it is of nylon, please make sure the water temperature does not exceed 50°C to prevent burning.
- Using stirred/flowing water can significantly reduce the dissolution time. PVA dissolves faster when water flows.
- Soak the model in water for about 10 minutes first, then remove most of the support with pliers, and then put the model back in water, so that PVA can be dissolved more easily.

### 2. Wash with water

After the PVA support is completely dissolved, rinse the model with water to remove the remaining PVA.

### 3. Dry the model

Dry the model completely and then perform additional post-processing on the model if necessary.

### 4. Waste water treatment

Since PVA is biodegradable, it is easy to dispose of waste water afterwards. When the waste water pipeline is connected with the waste water treatment unit, the waste water can be discharged through the waste water pipeline. After the disposal of the waste water, flush the drain pipe with hot water for 30 seconds to remove excess PVA in the drain pipe and avoid long-term blockage.

The water can be reused to soak multiple models, but it may increase the dissolution time. Therefore, it is recommended to use fresh water to achieve the fastest effect.

## 5.6 Camera Connection

Before using the camera, please remove the cover at the front of the camera.

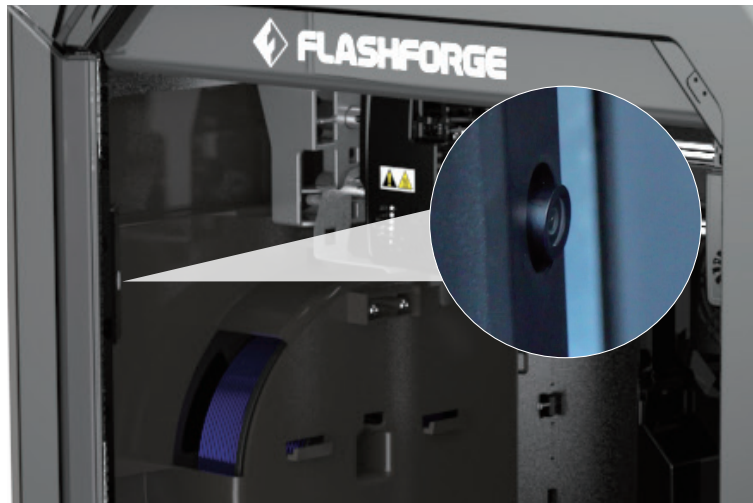

### · WLAN network camera connection

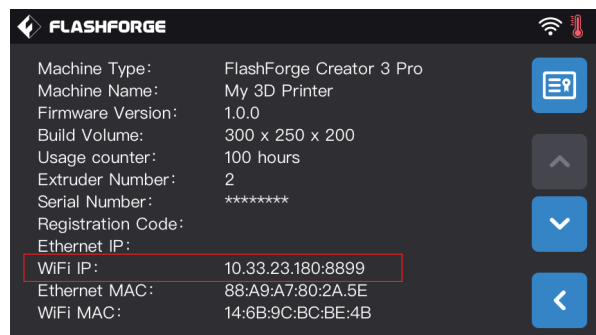
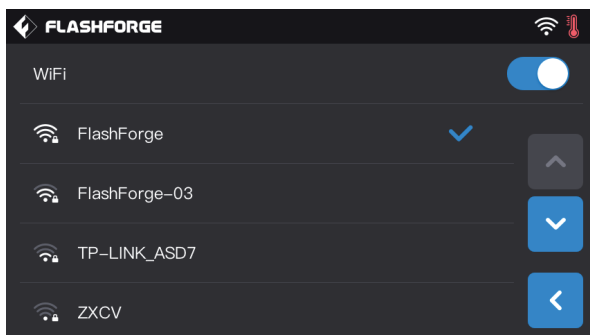

1. Click [Tools]-[Setting]-[WiFi] in the main interface of the touch screen of the equipment in turn, turn on the WLAN network connection button and connect to the network.

2. Click [Tools]-[Setting]-[About] in turn in the main interface to query and record the equipment Wi-Fi IP address: 10.33.23.180 (The example is for reference only. The local IP address shall prevail.)

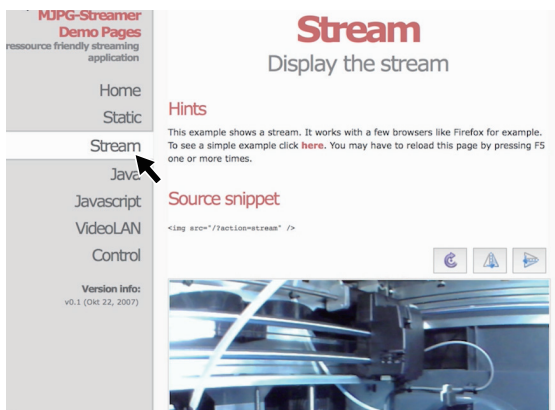

3. Open the browser, enter and go to the address 10.33.23.180:8080 (The example is for reference only. The local IP address shall prevail.), and click [Stream] to view the internal camera screen of Creator 3 Pro.

**Note:** The results of clicking [Stream] using a browser on a computer, mobile phone, or tablet computer are the same.

# 6. Equipment Operation Interface Introduction

**Note** Attention: The firmware is upgraded from time to time. Please refer to the actual display screen for the interface. The following is only a brief introduction of functions.

## 6.1 Printing Screen

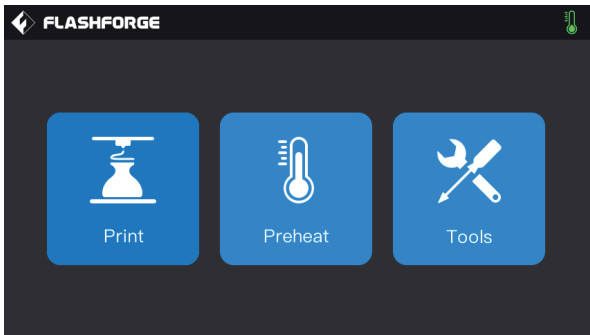

Click [Print] and select the model to be printed.

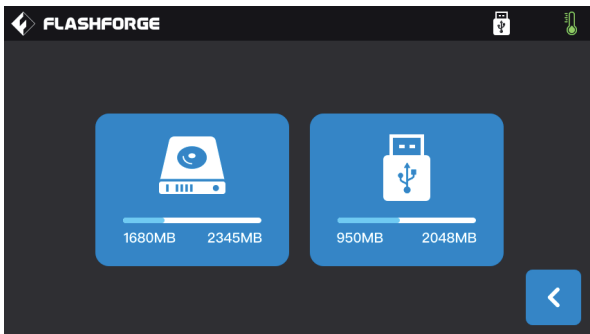

Select the path to read the printing file:

1. Read from the local memory card of the printer;
2. Read from the external USB disk.

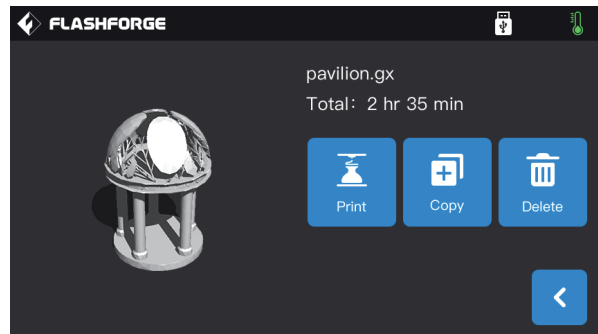

Select the printing file from the file list

1. **Print:** Start printing;
2. **Copy:** Copy the file from the USB disk to the local memory card of the printer (This function is unavailable when local memory card printing is selected);
3. **Delete:** Delete this printing file.

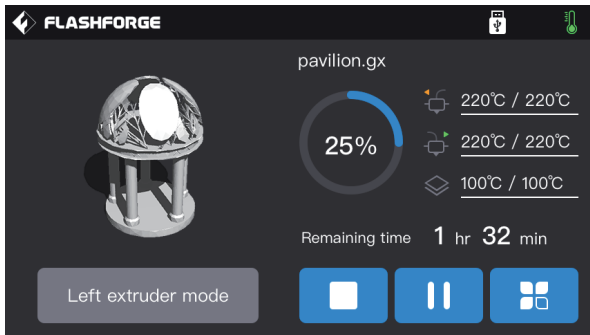

### Printing screen

1. **Stop:** Cancel the printing operation;
2. **Pause/Start:** Pause printing/start printing;
3. **More:** Query or modify in real time during printing: light status, filament changing setting, printing progress, printing speed, filament usage, printing time and z-axis coordinates;
4. **Left/right extruder temperature, build plate temperature:** The temperatures can be modified during printing.

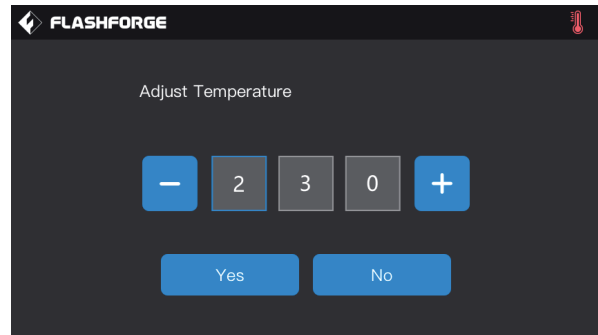

### Modify the left/right extruder temperature and raft temperature

When the extruder temperature reaches the target temperature value, click on the extruder temperature value after a underline appears. Select the number box, and click "-" and "+" to modify the set extruder temperature value.

Click [Yes] to save the set value; Click [No] to cancel the setting.

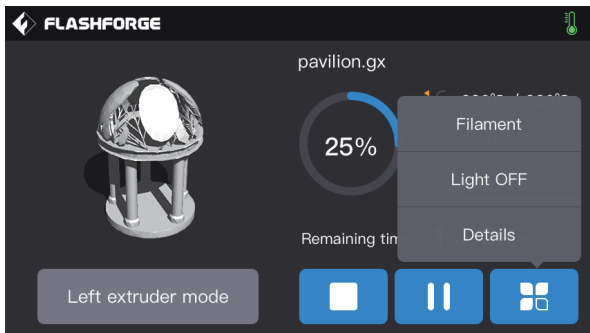

### Click more buttons during printing

You can query or modify these in real time: filament changing setting, light-off setting, and printing details (printing speed, filament usage, printing time, and Z axis coordinates).

1. **Filament:** When you need to change the filament in the middle of printing, you can click the [Filament] button (This function is available after the printing is paused);
2. **Light OFF:** You can turn on or off the light in real time by clicking the [Light OFF] button during printing;
3. **Details:**
  - a. **Printing speed:** You can click it to set the printing speed value during printing;
  - b. **Filament usage:** You can check the amount of the filament usage of the printing model (unit: meter);
  - c. **Printing time:** You can check the printing time;
  - d. **Z-axis coordinates:** You can check the Z-axis coordinates;
  - e. **Z Axis compensation;**
  - f. **Back:** You can cancel more commands and return to the printing screen.

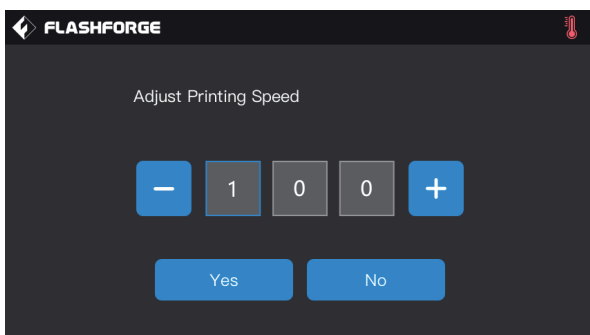
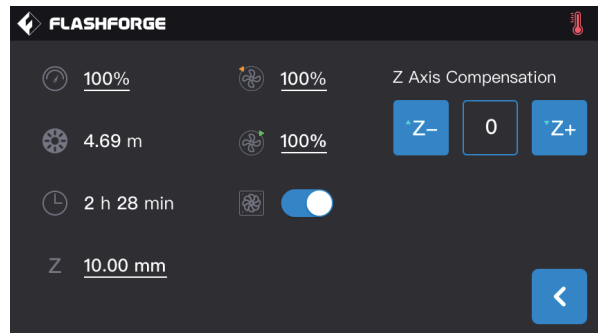

### Modify the printing speed

After starting printing, click on the printing speed value, select the number box, modify the set printing speed value by clicking "-" and "+", and click [Yes] to save the set value; Click [No] to cancel the setting.

## 6.2 Tools Screen

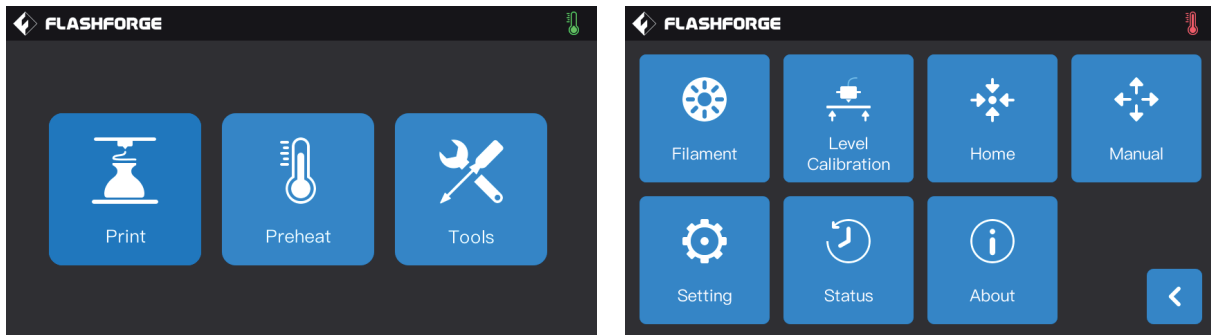

### Tools screen function:

1. **Filament:** You can perform filament loading/unloading operation;
2. **Level Calibration:** You can level and calibrate the extruder and build plate values;
3. **Home:** You can make the X/Y/Z axis of the printer back to the mechanical origin;
4. **Manual:** You can manually adjust the position of X/Y/Z axis;
5. **Setting:** You can set the relevant functions of the printer;
6. **Status:** You can check the real-time status of the printer;
7. **About:** You can check the version information of the printer, etc.

## 6.3 Setting Screen

[Tools]- [Setting]Click the setting icon to enter the setting screen.

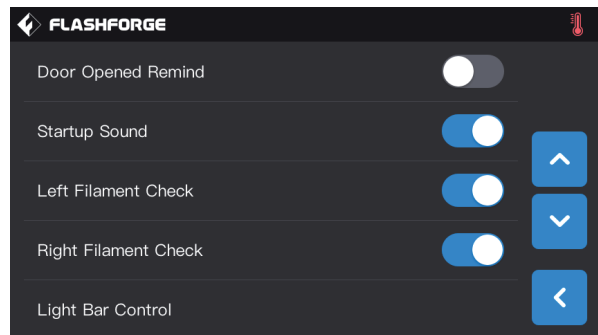
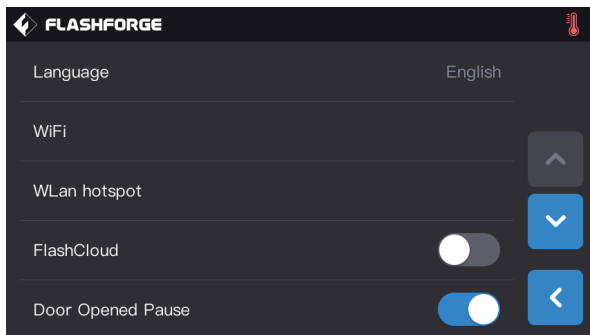

1. **Language:** To set the printer display language;
2. **WiFi:** To turn off/on the network connection;
3. **WLAN hotspot:** To turn off/on the Wi-Fi hotspot;
4. **FlashCloud:** To turn off/on the cloud connection for downloading and printing function;
5. **Door Opened Pause:** To turn off/on the door-opened pause;

6. **Door Opened Remind:** To turn off/on the door-opened reminder prompt;
7. **Startup Sound:** To turn on/off the start-up sound of the machine;
8. **Left Filament Check:** To turn on/off the left filament inspection function;
9. **Right Filament Check:** To turn on/off the right filament detection function;
10. **Light Bar Control:** To turn on/off the light bar inside the machine;

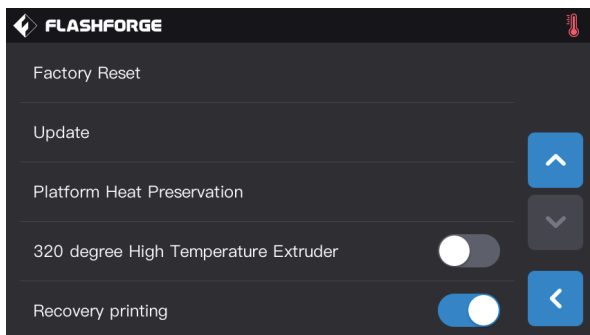



11. **Factory Reset:** To return to factory settings;
12. **Update:** To reserve the updated function;
13. **Platform Heat Preservation:** After printing, the platform is still in heat preservation;
14. **320 degree High Temperature Extruder;**
15. **Recovery printing:** Resume printing after recovering from power failure.

# 7. Maintenance

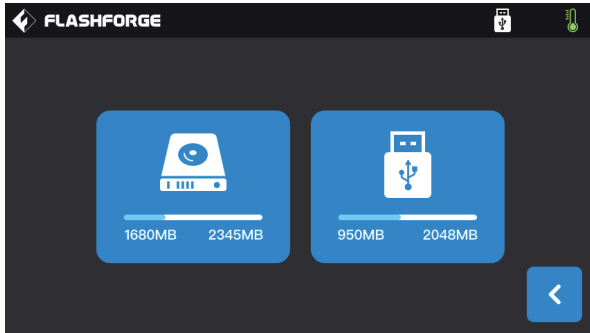
## 7.1 Copy the Log



1. Insert the USB disk, and an icon  will appear in the upper right corner of the touch screen of the equipment.
2. Click the icon , wait for 10 seconds, and unplug the USB disk.
3. Insert the USB disk into the computer and open the USB disk folder to find the log file.
4. Please send the log file to Flashforge After-sales Service.

## 7.2 Maintenance and Service

Problem	Cause	Solution
The extruder is off-center.	The equipment has lost the precise position track of the extruder and thus leading to printing failure.	Remove the model, clean the build plate, return the extruder back to its original position, and recalibrate. Then print a new model.
Filaments are not properly extruded or adhering to the build plate.	It may be that the build plate is not leveled and the distance between the build plate and the extruder is inconsistent.	Re-level.
The equipment does not respond before starting printing the model.	The equipment may have received conflicting commands.	Turn off the power switch, wait for 30 seconds, and then turn on the power switch.
At the end of printing, filaments are attached to the nozzle in blocks; Or filaments are scattered in the printer in the form of filaments.	A layer of the model did not adhere correctly, and the minimum surface area in contact with the build plate was adopted when saving the model; Or no support is selected when printing and it is suspended above the build plate.	Re-slice the model and add supports if necessary.
The model is only half printed.	The printing filaments run out. The extruder is blocked during printing.	Replace the printing filament, turn on the filament detection function, and continue printing; See "The printing filament cannot be extruded" below for more.
The printing filament cannot be extruded.	The extruder is blocked.	Use the unclogging pin tool to push the filament in the filament feeding state. Contact After-sales Service.
The extruder can not return to its original position.	Limit switch line fault.	Contact After-sales Service.
In the steep protruding part, the surface of the model is slender and sparse or worn.	The model protrudes too far or shakes too much. (angle less than 45 degrees).	Print with supports.

## 7.3 Unclog the Nozzle

1. Click [Preheat], set the heating temperature, and tap the Return button.
2. Click [Tools]-[Filament]-target extruder [Load], wait for the extruder to heat up until the screen prompts for filament feeding, and insert the pin into the extruder inlet (top).
3. Push the blocked residue down and squeeze it out from the nozzle. If you encounter some resistance, you can push down. Be careful not to use brute force. If you have tried doing this several times and it still can not be clogged with force, then you need to replace the nozzle or contact after-sales customer service.

## 7.4 Replace the Nozzle Assembly

Please operate with the power off:

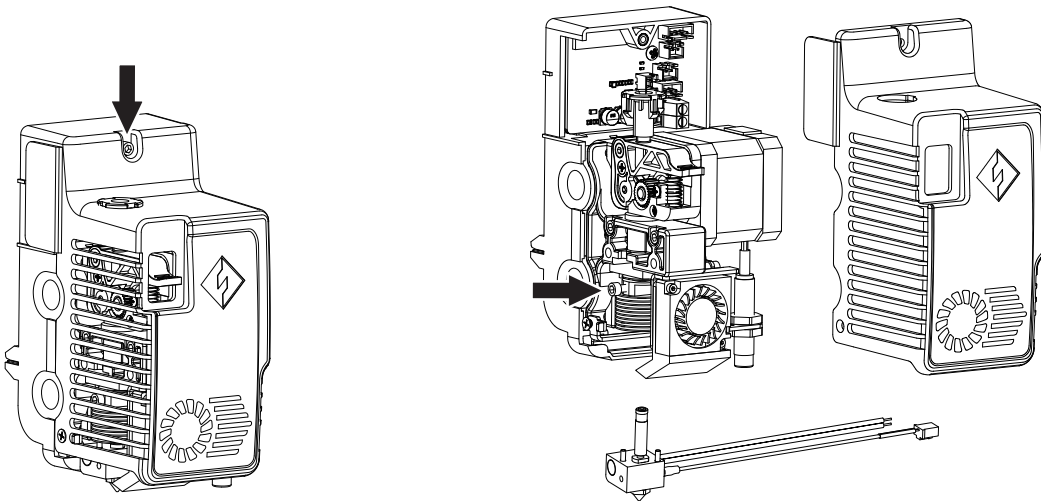

1. Unscrew the screws with an Allen screwdriver and remove the extruder cover;

2. Unscrew the screws here and pull out the wire harness of the heating pipe and thermocouple;

3. Replace the nozzle assembly with a new one. Be sure to push the nozzle assembly to the bottom, and there must be no installation gap. Tighten the corresponding screws; Insert the wire harness into the extruder circuit board; Cover the housing and lock the screws.



## 7.5 Anti-oozing Plate

It is a normal phenomenon that the anti-oozing plate may have partial scratches on itself due to factory testing. With the continuous use of printing, scratches will become more obvious, but this will not affect the use of the nozzles, and the distance between the anti-oozing plate and the nozzles can be adjusted manually. Please make sure that the nozzles are always in contact with the anti-oozing plate when in use. If the scratches are deep, it can be replaced according to the actual situation.

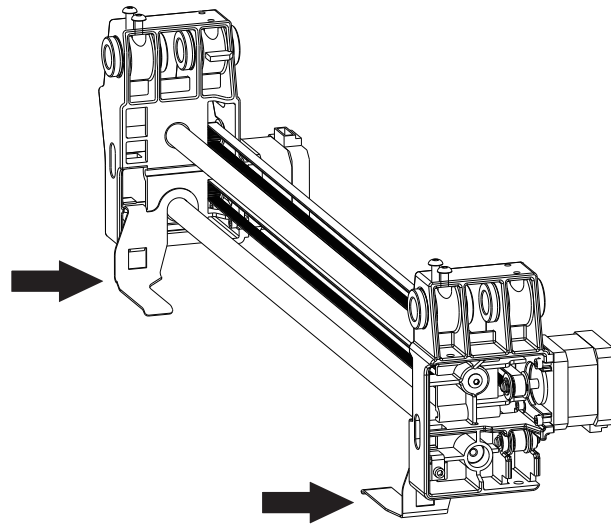

## 7.6 Daily Maintenance and Use Suggestion

1. When the equipment is not used in daily life, please cover the top cover and close the front door to avoid dust falling on the equipment. If the equipment is not used for a long time, it is recommended to use original package for sealing.
2. Lubricate the moving parts regularly. If the equipment is used frequently, add lubricating oil (grease) at least once every three months; If the equipment is not used for a long time, add lubricating oil (grease) at least once every six months.
3. After each printing, please clean up the filament residue and other sundries in the printing cavity in time to avoid small sundries falling into the bottom circuit board and affecting the use of the equipment.
4. Printing stickers are consumables. When the adhesion of the build plate's stickers drops or even the sticks are damaged, please replace the printing stickers in time so as not to affect the printing effect.
5. After using the equipment for the first time or replacing the printing filaments, Flashforge official filaments shall be used until the colors of the filaments extruded from the nozzles are consistent with the colors of the filaments loaded.
6. At any time, it is recommended to place the model at the center of the build plate. You can set the placing position of the model in the slicing software.
7. Support printing is recommended for steep protruding parts (angle less than 45 degrees).

## 8. Support and Service

Flashforge professional after-sales service personnel and salesmen are on standby for you at any time, and are very willing to help you solve any problems you encountered during use. If you can't find the answer from the user guide, you can go to our official website to search for the solution of your problem, or contact us by phone.

Some explanations and solutions of common problems can be found in our official website. Many of your problems can be solved in [www.flashforge.com](http://www.flashforge.com), the official English website of Flashforge.

The Flashforge after-sales team can be reached by email or phone from 8:00 a.m. to 5:00 p.m. from Monday to Saturday to solve your problems. In case you contact us during off-duty time, your inquiry will be answered the next following business day immediately. We are sorry for any inconvenience caused.

**Note:** Due to the replacement of different filament, there will be a small amount of impurities left in the extruder, which will cause the extruder blockage. As this can be solved by just unclogging it, this is not a quality problem. If our user encounters this problem when using the equipment, please contact our after-sales department, and complete the unclogging work under the guidance of the after-sales personnel.

After-sales Service Tel: +86-400-886-6023

E-mail: [support@flashforge.com](mailto:support@flashforge.com)

Address: No. 518, Xianyuan Road, Wucheng District, Jinhua City, Zhejiang Province, China

**Note:** Please provide the product serial number which is the barcode at the back of the printer before contacting our after-sales department.



# 前言

注：每台3D打印机在出厂前都经过打印测试，若设备喷头内存在耗材残留或打印平台有轻微划痕，均属正常现象，不影响使用。

尊敬的闪铸用户，

感谢您选择使用闪铸科技的产品。感谢您对闪铸科技的大力支持和帮助。

请您在使用之前仔细阅读该说明书，并严格按照说明书的指示进行操作。整个闪铸科技团队将为您提供优质的服务。在使用过程中无论遇到什么问题，请按照说明书结尾所提供的电话及邮箱与我们联系。

为了您能够更好地体验我们的产品，您还可以从以下途径获取设备的操作知识：

## (1) 说明书：

请您小心拆箱，您可以从最上层的泡沫中取出附带的文件或从U盘中浏览最新的说明书。这将帮助您熟悉设备并成功完成初次打印体验。

## (2) 闪铸官网：

闪铸中文官方网址：[www.sz3dp.com](http://www.sz3dp.com)

闪铸英文官方网址：[www.flashforge.com](http://www.flashforge.com)

您可以登陆闪铸官网获得相关软硬件、联系方式、设备操作、设备保养等相关信息。

# 注意事项

请确保认真阅读以下安全提示

## 工作环境安全

- ◆ 请保证打印机的工作台面干净整洁。
- ◆ 请保证打印机工作时远离可燃性气体、液体及灰尘。（设备运行产生的高温有可能会与空气中的粉尘、液体、可燃性气体反应引发火灾）
- ◆ 儿童及未经培训的人员请勿单独操作设备。

## 用电操作安全

- ◆ 请务必将设备接地；切勿改装设备的插头。（未接地/未正确接地/改装插头必然会增加漏电风险）
- ◆ 请勿将设备暴露在潮湿或烈日的环境中。（潮湿的环境会增加漏电的风险/暴晒会加速塑件老化）
- ◆ 请勿滥用电源线，务必使用闪铸科技提供的电源线。
- ◆ 切勿在雷雨天气使用设备。
- ◆ 如长时间不使用设备，请关闭设备并拔下电源线插头。

## 个人操作安全

- ◆ 在设备运行时，请勿触碰喷头、平台等位置。
- ◆ 在打印完成时，请勿触碰喷头。
- ◆ 在操作设备时，请勿穿戴围巾、口罩、手套、珠宝装饰等容易卷入设备的物件。
- ◆ 请勿在饮酒、服药之后操作设备。

## 设备使用提示

- ◆ 切勿长时间离开正在运行的设备。
- ◆ 请勿自行对该设备进行任何改装。
- ◆ 请在设备进丝操作时，使喷头和平台的距离至少保持50mm的距离。（距离过近，有可能会造成喷头堵塞）
- ◆ 请在通风的环境下操作设备。
- ◆ 请勿利用该设备进行违法犯罪的活动。
- ◆ 请勿利用该设备制作食物储存类产品。
- ◆ 请勿利用该设备制作电器类产品。
- ◆ 请勿将打印模型放入口腔。
- ◆ 请勿用蛮力卸下打印模型。
- ◆ 请勿使用长度大于3米的网线连接本设备。

## 设备运行环境要求

- ◆ 温度：室温15-30°C为宜
- ◆ 湿度：20%-70%为宜。

## 设备放置要求

- ◆ 设备需要放置于干燥通风的环境中。设备左侧、右侧以及后侧必须要留至少20cm的距离，前侧必须要留至少35cm的空间距离。

## 设备兼容耗材要求

- ◆ 在使用该设备时，请使用闪铸提供或指定的耗材。市场上耗材鱼龙混杂，质量良莠不齐。质量低劣或不兼容的耗材很容易造成喷头堵塞及喷头损坏。

## 耗材储存要求

- ◆ 除非需要使用耗材，否则请勿轻易将耗材拆封。拆封后请将耗材储存在干燥、无尘的环境中。

## 法律禁止项目

- ◆ 请勿复制或打印法律禁止复制的任何项目。
- ◆ 根据当地法律，复制或打印以下项目一般属于违法行为：
  - 1、枪支
  - 2、复制受版权保护的作品。一些受版权保护的作品可以被部分复制以进行“合理使用”。多份复制将被视为不正当使用。艺术作品等同于受版权保护的作品。
- ◆ 以上列表仅作参考，并不包括所有内容在内。对于其完整性及准确性，本公司概不承担责任。如果您有与复制或打印某些项目的合法性相关的问题，请咨询法律顾问。

## 法律声明

- ◆ 用户无权对此使用手册进行任何修改。
  - ◆ 客户若自行拆装或改造设备造成任何安全事故，闪铸科技概不负责。未经闪铸科技允许，任何人不得对该手册进行修改或翻译。
  - ◆ 本手册受版权保护，闪铸科技对本手册保留最终解释权。
  - ◆ 后续因设备升级，闪铸科技保留对说明书修改的权利。
- 
- ◆ 第一版（2021年7月）  
@Copyright 2021浙江闪铸三维科技有限公司版权所有

## 服务

- ◆ 实施任何服务之前，请先拔出金刚狼3 Pro的电源插头。如果不这样做，则可能造成人员受伤及设备损伤。只能使用闪铸科技核准的耗材和组件，否则可能导致保修无效。

# 目录

<b>设备参数</b>	<b>34</b>
<b>第一章 设备简介</b>	<b>35</b>
1.1 - 整机介绍	35
1.2 - 装箱清单	36
1.3 - 设备开箱的注意事项	37
<b>第二章 打印前准备</b>	<b>38</b>
2.1 - 安装丝料	38
2.2 - 调平与校准	41
2.3 - 网络链接	42
<b>第三章 软件安装</b>	<b>43</b>
<b>第四章 首次打印</b>	<b>43</b>
4.1 - 传输文件：Wi-Fi传输	43
4.2 - U盘打印	44
4.3 - 云打印	44
4.4 - 打印完成移除模型	44
<b>第五章 设备的配置与操作</b>	<b>45</b>
5.1 - 设置双头打印模式	45
5.2 - 镜像复制模式	46
5.3 - 材料配置	48
5.4 - 材料设置	48
5.5 - 水溶性支撑材料的去除方式	49
5.6 - 摄像头连接查看	50
<b>第六章 设备操控界面简介</b>	<b>51</b>
6.1 - 打印界面	51
6.2 - 工具界面	53
6.3 - 设置界面	54
<b>第七章 维护</b>	<b>55</b>
7.1 - 拷贝日志	55
7.2 - 维护与检修	55
7.3 - 疏通喷嘴	56
7.4 - 如何更换喷嘴组件	56
7.5 - 防溢丝板	57
7.6 - 日常保养及使用建议	57
<b>第八章 帮助与支持</b>	<b>58</b>

## 设备参数

打印机名称	金刚狼3 Pro
喷头个数	2 (独立)
技术基础	丝熔制造 (FFF)
屏幕	4.3英寸彩色 IPS 触摸屏
打印尺寸	300×250×200mm
层厚	0.05 - 0.4mm
打印精度	±0.2mm
定位精度	Z轴: 0.0025mm; XY轴: 0.011mm
打印材质	PLA/ABS/PETG/PA/PC/HIPS/ASA/PLA-CF/PETG-CF/PACF/ WOOD
耗材直径	1.75mm (±0.07mm)
喷头直径	0.4mm
打印速度	10~150mm/s
软件名称	FlashPrint
支持格式	输入: 3MF/STL/OBJ/FPP/BMP/PNG/JPG/JPEG文件 输出: GX/G文件
操作系统	Win xp/Vista/7/8/10、Mac OS、Linux
打印机尺寸	627×485×615mm
净重	40Kg
数据传输	U盘、WiFi、以太网

# 第一章 设备简介

## 1.1 整机介绍

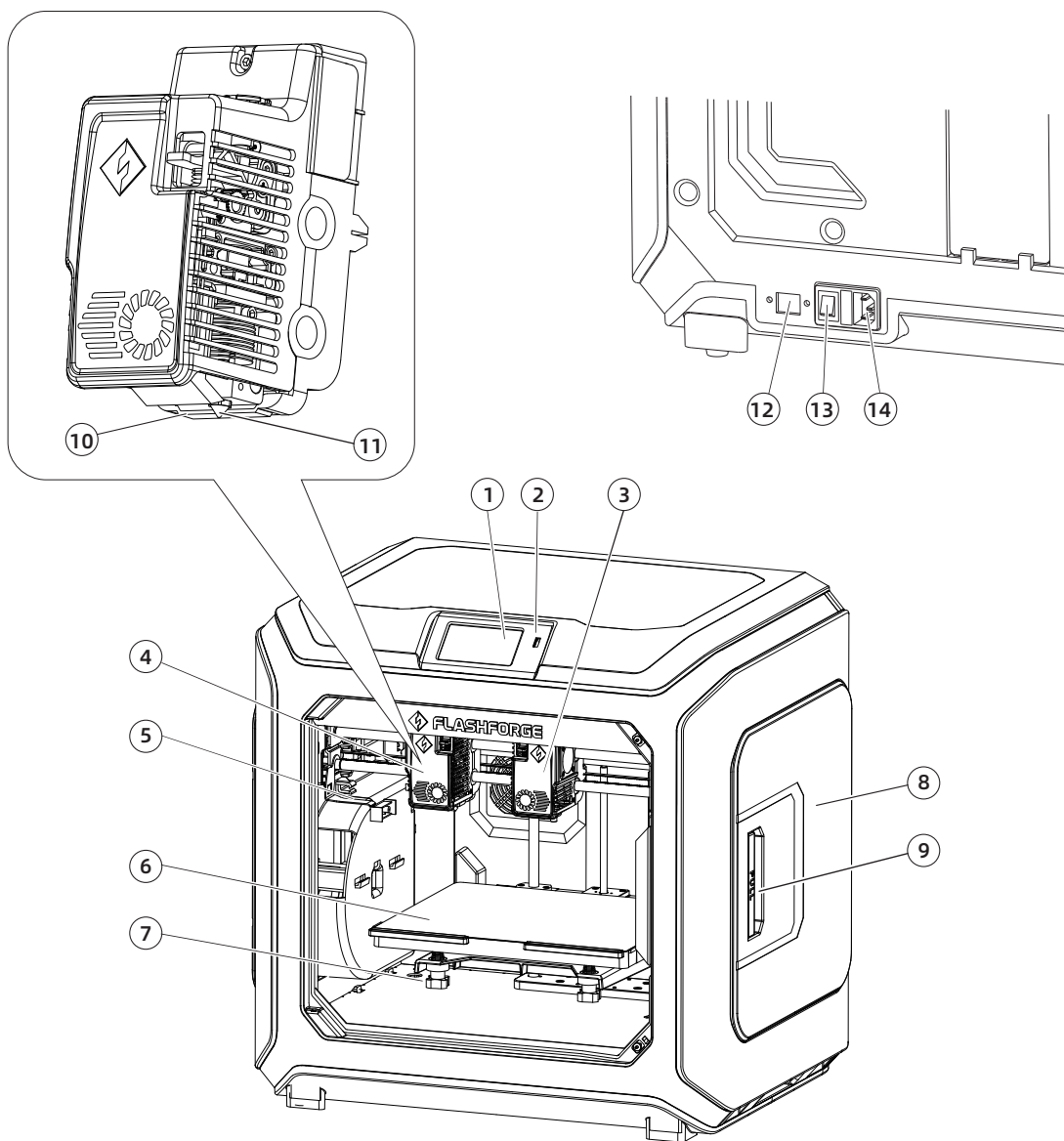

- 1、触摸屏
- 2、U盘端口
- 3、右喷头
- 4、左喷头

- 5、金属防漏丝板
- 6、打印平台
- 7、调平螺母
- 8、丝盘盖

- 9、丝盘盖把手
- 10、导风嘴
- 11、喷嘴
- 12、以太网接口

- 13、电源开关
- 14、电源线接口



## 1.2 装箱清单

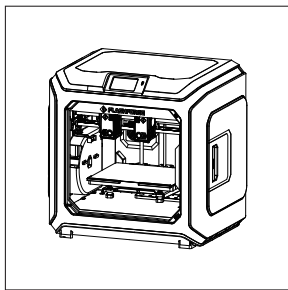

3D打印机

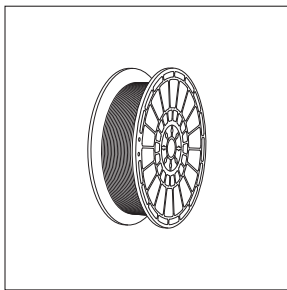

3D打印耗材



用户使用手册

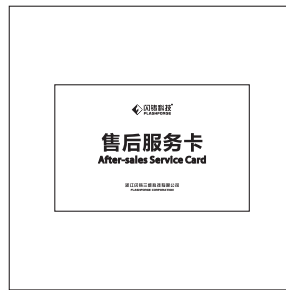

售后服务卡

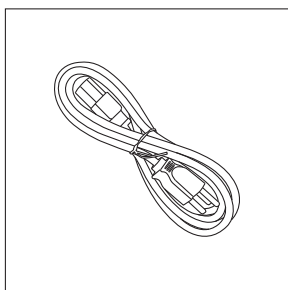

电源线

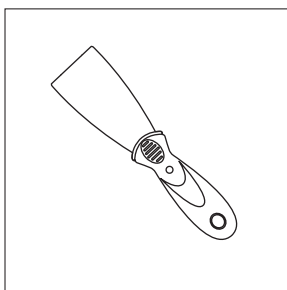

铲刀

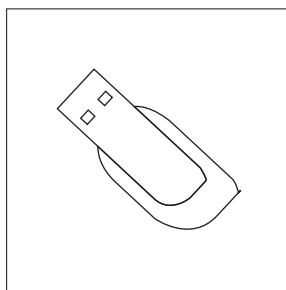

U盘

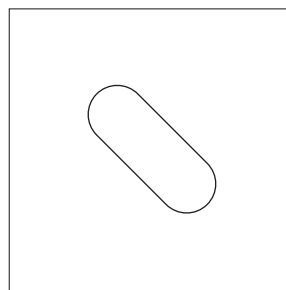

调平卡

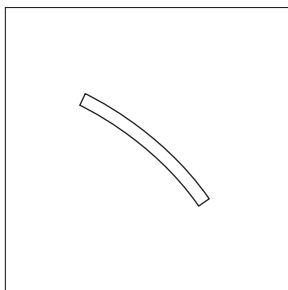

聚四氟乙烯管

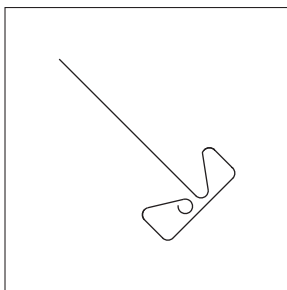

通针

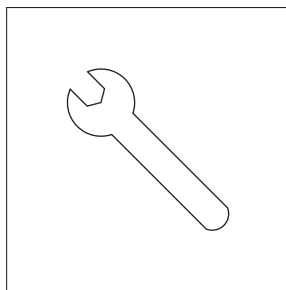

冲压扳手

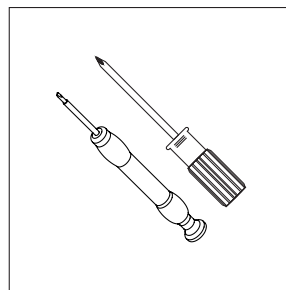

螺丝刀

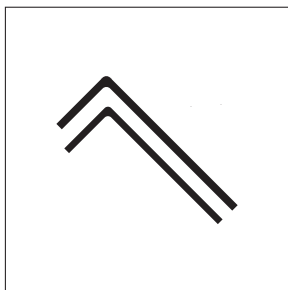

内六角扳手

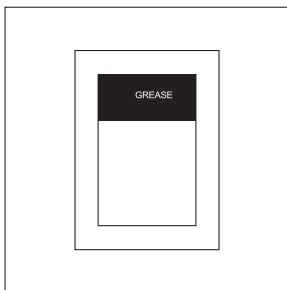

润滑脂

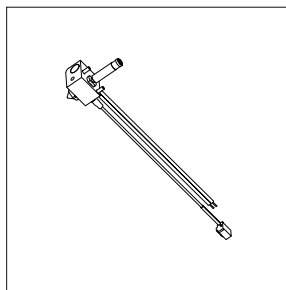

喷嘴组件

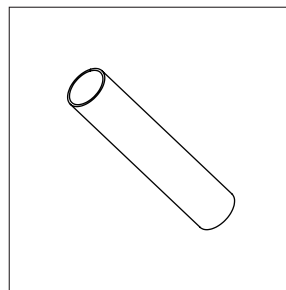

喷嘴支撑管

## 1.3 设备开箱的注意事项

1. 取出顶部配件与珍珠棉;
2. 移除身上的胶带;
3. 取出内部的珍珠棉块;

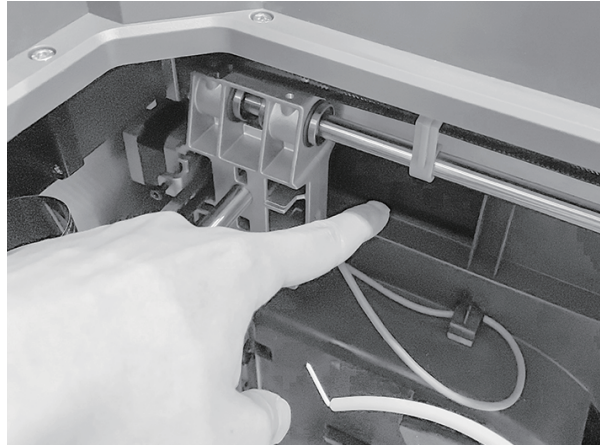
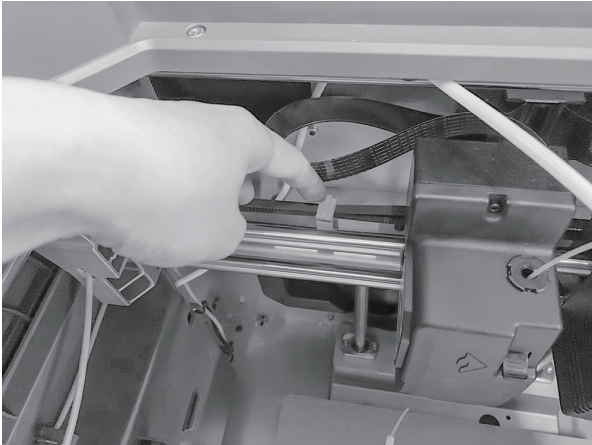

4. 移除X轴、Y轴同步带上的卡扣;

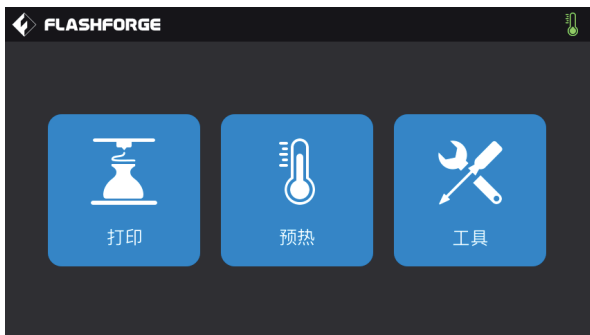

5. 打印机连接电源，开机后，在触摸屏上依次点击【工具】、【手动调节】进入手动控制界面;

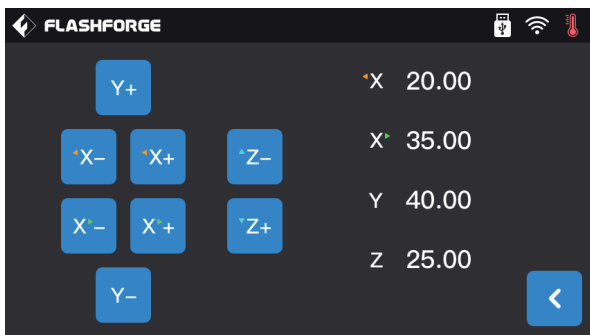

6. 持续按住【Z-】，直到打印平台上升到较高的位置，取出下方的泡沫块。

## 第二章 打印前准备

### 2.1 安装丝料

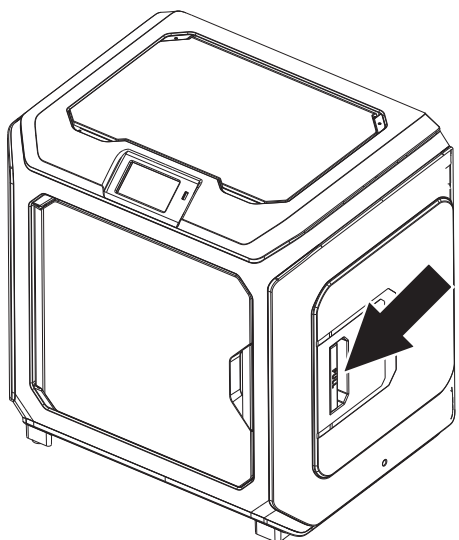

1. 打开丝盘盖。

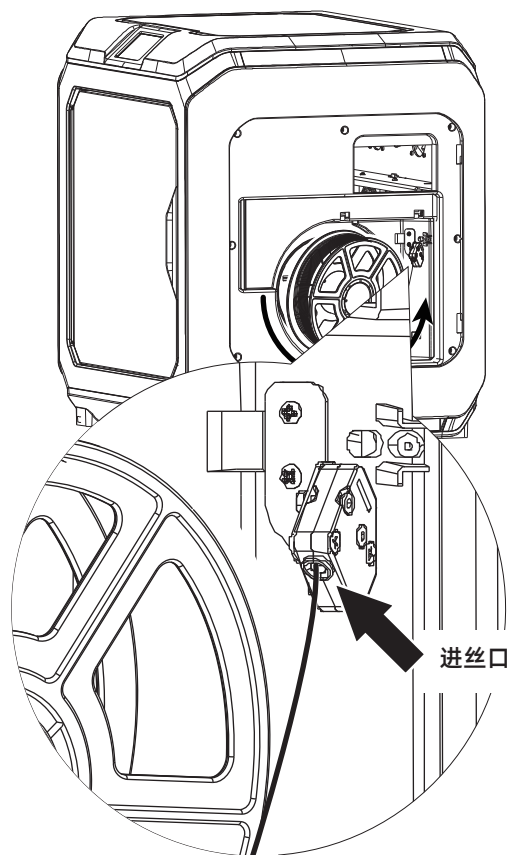

2. 取出耗材，将耗材插入进丝口中。

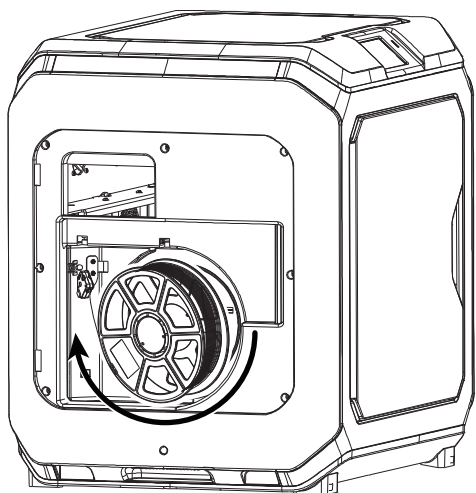

3. 注意：为方便耗材转动顺畅，请按图中所示的方向安装耗材。

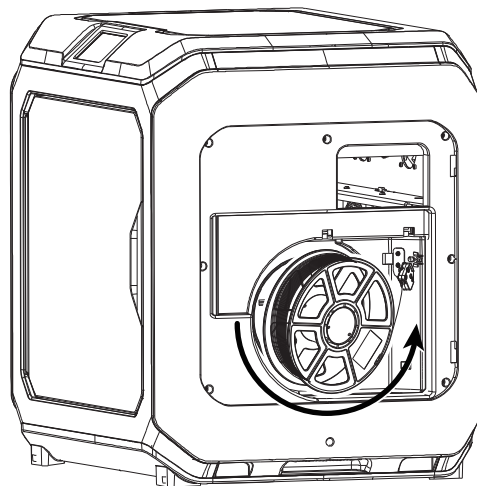

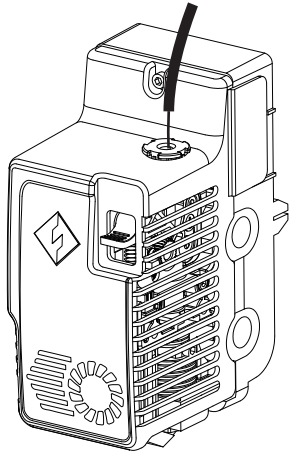

4. 持续将耗材送入进丝口，直到耗材从导丝管穿出。

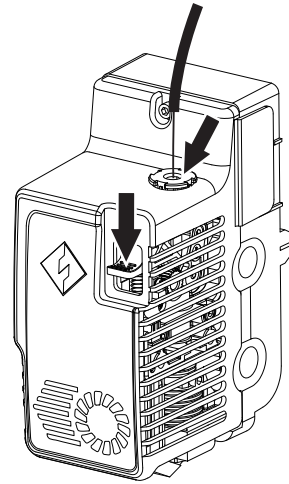

5. 按下喷头前方的进丝压板，将耗材垂直插入喷头，直到无法继续插入。松开进丝压板。

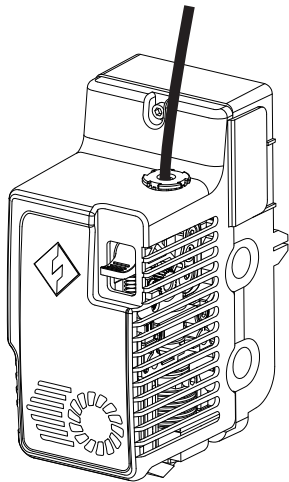

6. 将导丝管插入喷头进丝孔中固定。

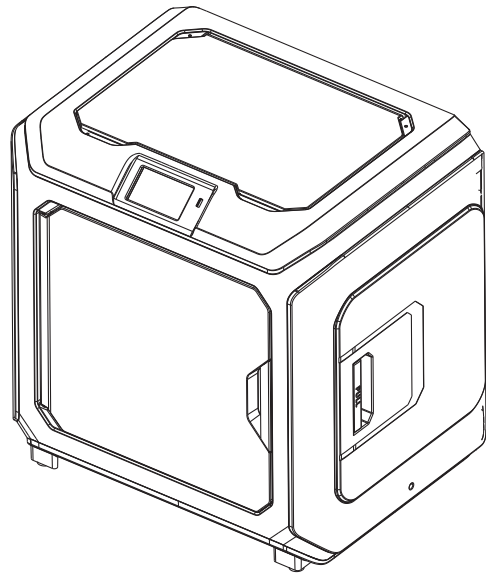

7. 最后将丝盘固定在丝盘架上，盖上丝盘盖。

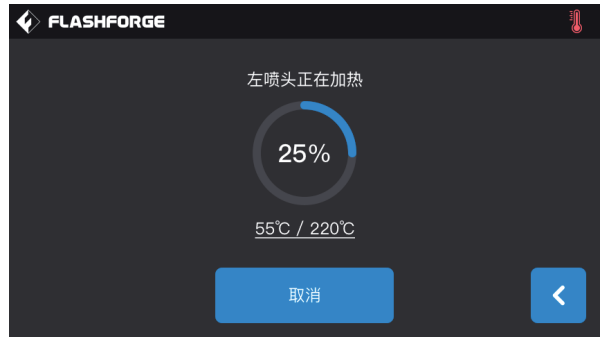
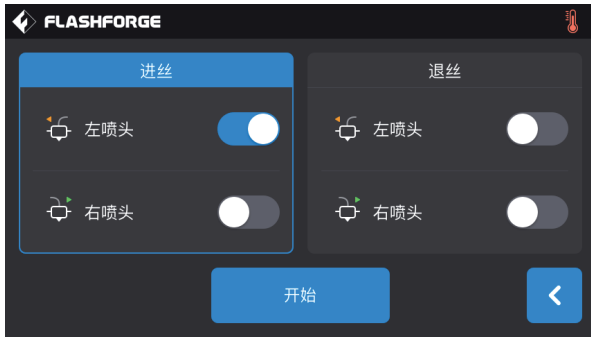
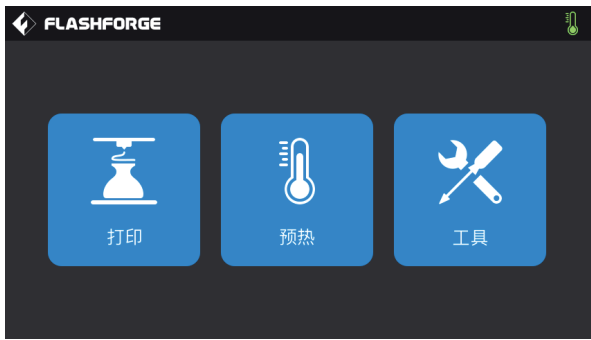

8. 进丝操作：点击屏幕中的【工具】-【换丝】按钮，根据材料所需温度值设置合理加热温度；根据屏幕提示进行操作，等待喷嘴挤出均匀的耗材。

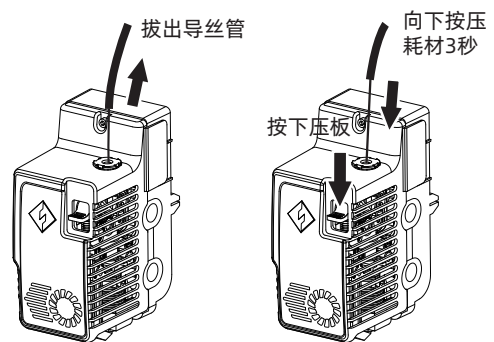

退丝操作：点击【退丝】，待喷头温度加温完成后，向下压耗材压板，拔出白色耗材导丝管，将耗材迅速向上拔出，退丝完成。

## 2.2 调平与校准

设备出厂已进行过调平校准，由于运输中会产生震动，调平面可能会被破坏，建议首次打印前进行一次调平。调平方式有两种模式：辅助调平模式和手动调平模式。在辅助调平模式下，所有执行将借助喷头传感器及辅助提示完成。当功能选项在手动模式时，辅助模式中的平台调平将不启动传感器功能。

设备总共包含如下调平校准：平台调平，XY校准，Z轴校准，9点调平；

按如下顺序进行操作：

1. 在触控屏上点击【工具】、【调平与校准】；
2. 选择辅助模式进行调平校准；
3. 喷头传感器校准已在出厂前完成设定，无需再操作；点击平台调平，按照屏幕指示进行操作；
4. 进行Z轴校准，按屏幕提示进行操作；
5. X.Y轴在出厂前已经完成校准，无需再操作；
6. 整个调平校准完成。



9点调平功能：在平台调平以及XY/Z轴校准后，打印平面度仍较差时，可以使用该功能进行补偿，以获得更好的平面度；



手动调平模式：依次执行平台调平、Z轴校准、XY轴校准。此为一套完整的调平校准操作流程。

## 2.3 网络链接

### · 有线网络连接

将网线插到设备的网线插口，屏幕右上角出现  图标，则表明设备已经成功连接上网络。

### · WLAN网络连接

在设备触摸屏的主界面依次点击【工具】-【设置】-【WLAN网络】，开启无线局域网，选择需要连接的网络。屏幕右上角出现  图标，则表明设备已经成功连接上网络。

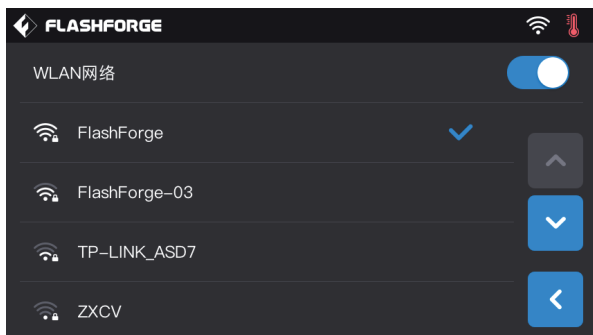

### · WLAN热点连接

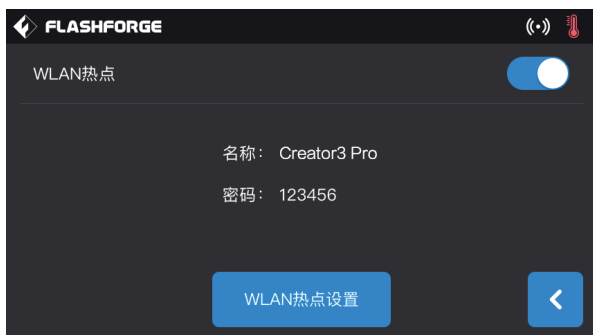

1、在设备触摸屏的主界面依次点击【工具】-【设置】-【WLAN热点】，开启设备热点。您可以自由设置热点的名称和密码。屏幕右上角出现  图标，则表明设备已经成功开放热点。



2、使用笔记本电脑搜索到您设置的热点，并点击连接，输入密码。

建议：如果同时拥有多台金刚狼3 Pro，请进入WLAN热点设置中分别修改热点名称。

# 第三章 软件安装

方法一：在U盘中找到FlashPrint软件安装包，选择对应的系统版本进行安装。

方法二：从中文官方网站www.sz3dp.com或英文官方网站www.flashforge.com下载最新的切片软件进行安装。

## 3D 打印过程：

获取模型文件 - 使用切片软件进行切片 - 文件传输至打印机打印。

# 第四章 首次打印

## 4.1 传输文件：Wi-Fi传输

将STL或OBJ文件导入到FlashPrint进行切片，选择金刚狼3 Pro连接机器（可通过输入IP地址或自动扫描的方式，IP地址可在【设备关于】中查看）。切片完成后直接发送至打印机。

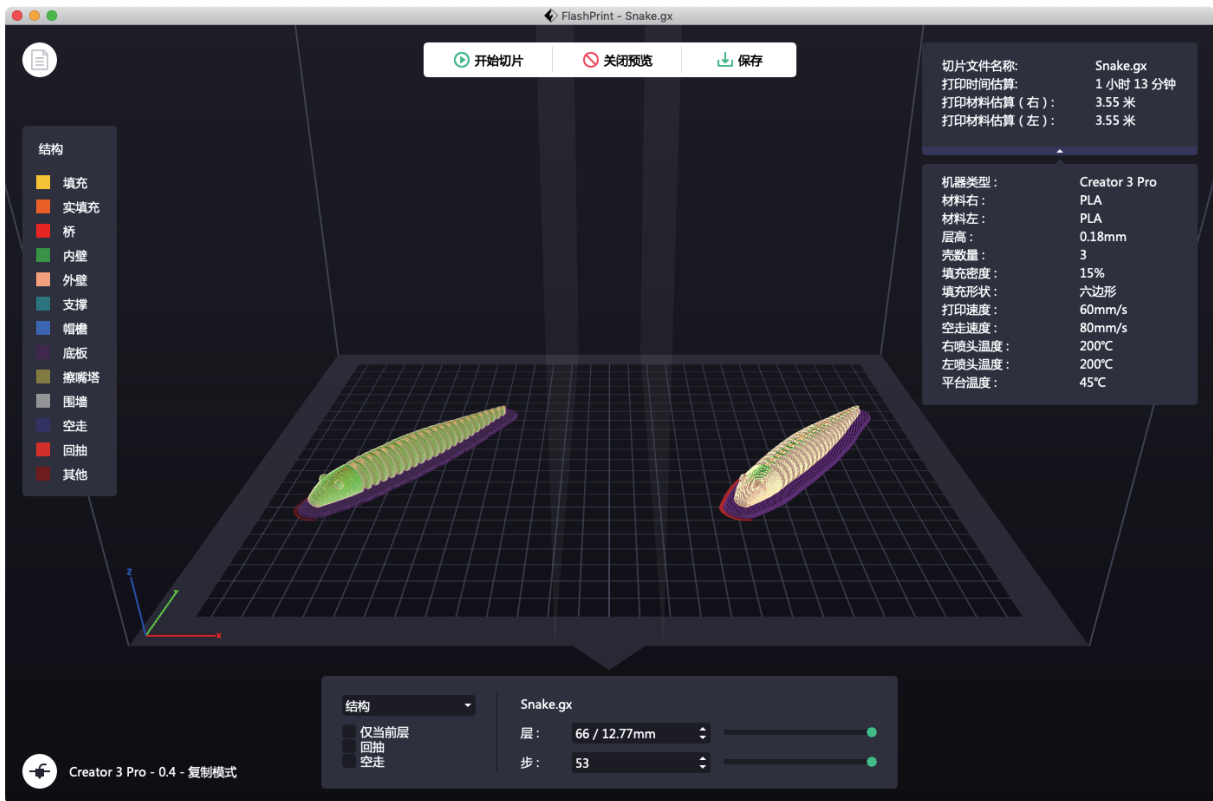



## 4.2 U盘打印

设备可通过U盘打印：将切片好的文件保存至U盘，将U盘插入到设备，选择对应文件即可打印。

## 4.3 云打印

1. 打开闪铸云网站，注册账号，经过邮箱激活后，即可登录使用。

闪铸云：<https://cloud.sz3dp.com>



2. 点击【我的打印机】-【添加打印机】。

在添加打印机页面填写注册号（云注册码），为打印机起个名字，点击确定后，这些信息会出现在打印机的闪铸云界面。

## 4.4 打印完成移除模型

### ⚠ 注意事项

**注意：**等待平台冷却后再操作。

**警告：**使用手动工具从打印平台上移除模型时，请注意安全。从打印平台移除模型时，突发性工具打滑和身体位置不当可能导致人员受伤。

**当心：**移除模型时，请勿刮花打印平台。打印平台中的划痕将会导致模型创建错误。

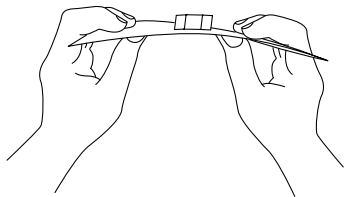

取下磁性钢板，将其折弯即可取下模型。

# 第五章 设备的配置与操作

## 5.1 设置双头打印模式

双头打印模式时若打印双色/双材料模型，请确保喷嘴接触防溢丝板。这可避免喷嘴在打印过程中溢料。

金刚狼3 Pro默认左喷头作为支撑材料喷头，右喷头为打印喷头。当打印单色模型时，若用户未进行设置，自动使用右喷头作为打印的喷头，打印有如下模式可设置：

在专家模式下：

- 1、载入模型；
- 2、选择支撑类型，点击【线性支撑】；
- 3、自动添加支撑，点击【支撑】>【自动支撑】；
- 4、点击【开始切片】，进入参数配置页面；
- 5、选择配置材料，比如 Creator 3 Pro PLA+PVA；
- 6、点击【切片】。

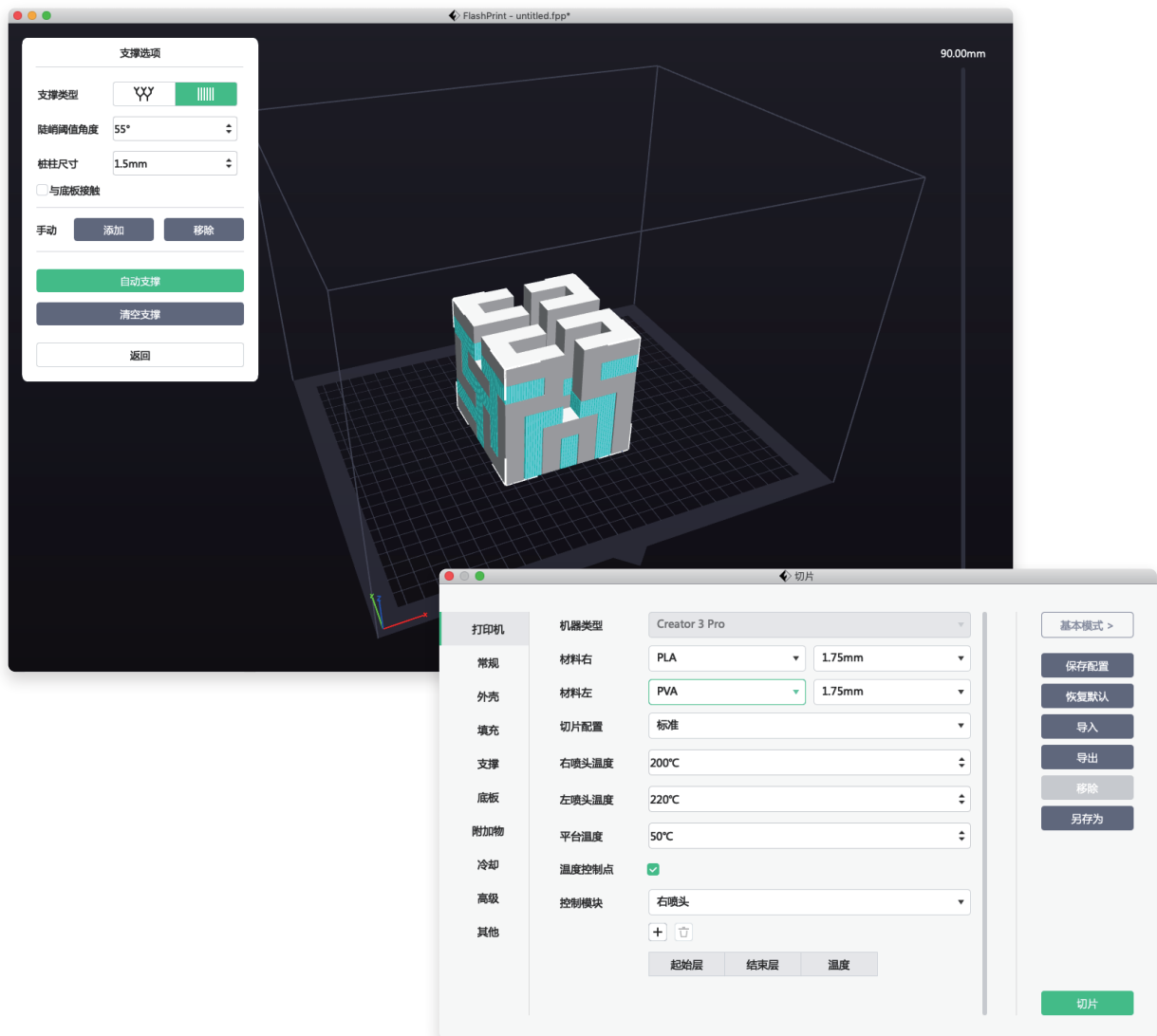

## 5.2 镜像复制模式

当需要打印两个相同或者镜像的模型，可以选择镜像/复制模式，在此类模式下，左右喷头将同时打印模型。（注意镜像/复制模式下，模型X轴大小仅支持小于133mm的模型）

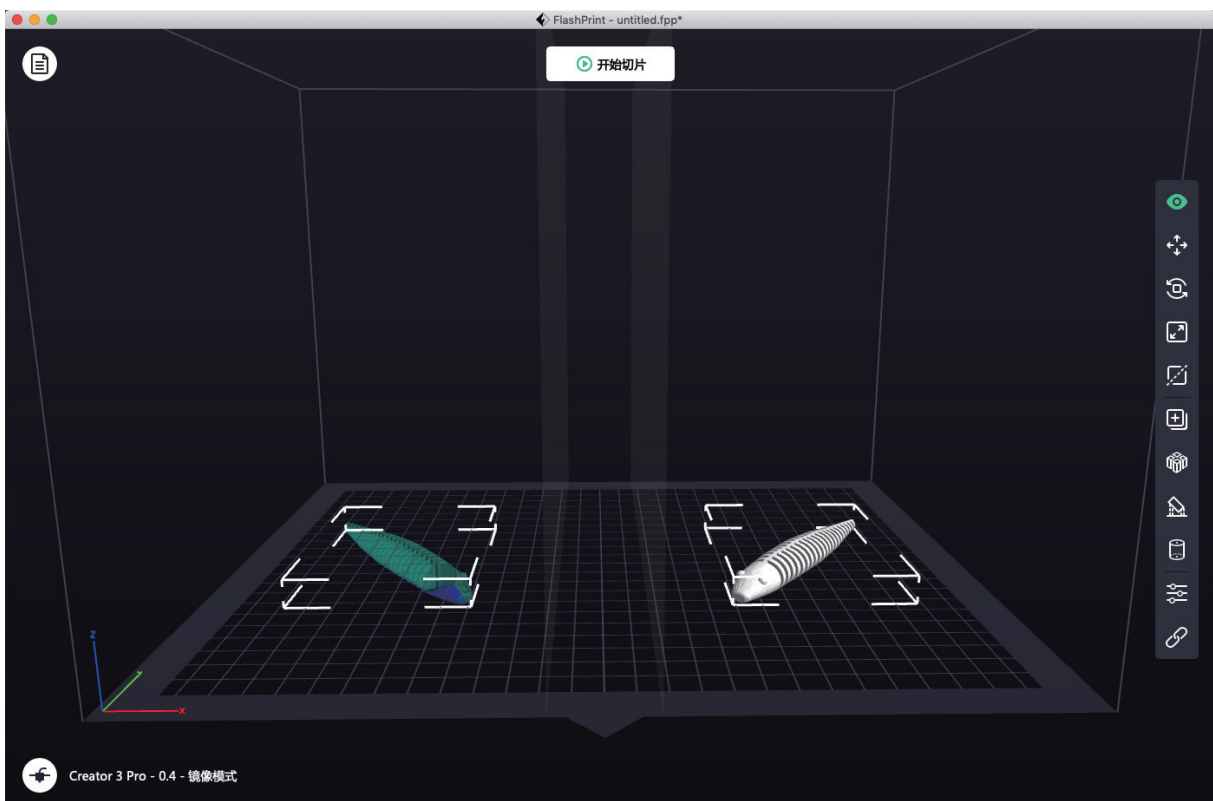
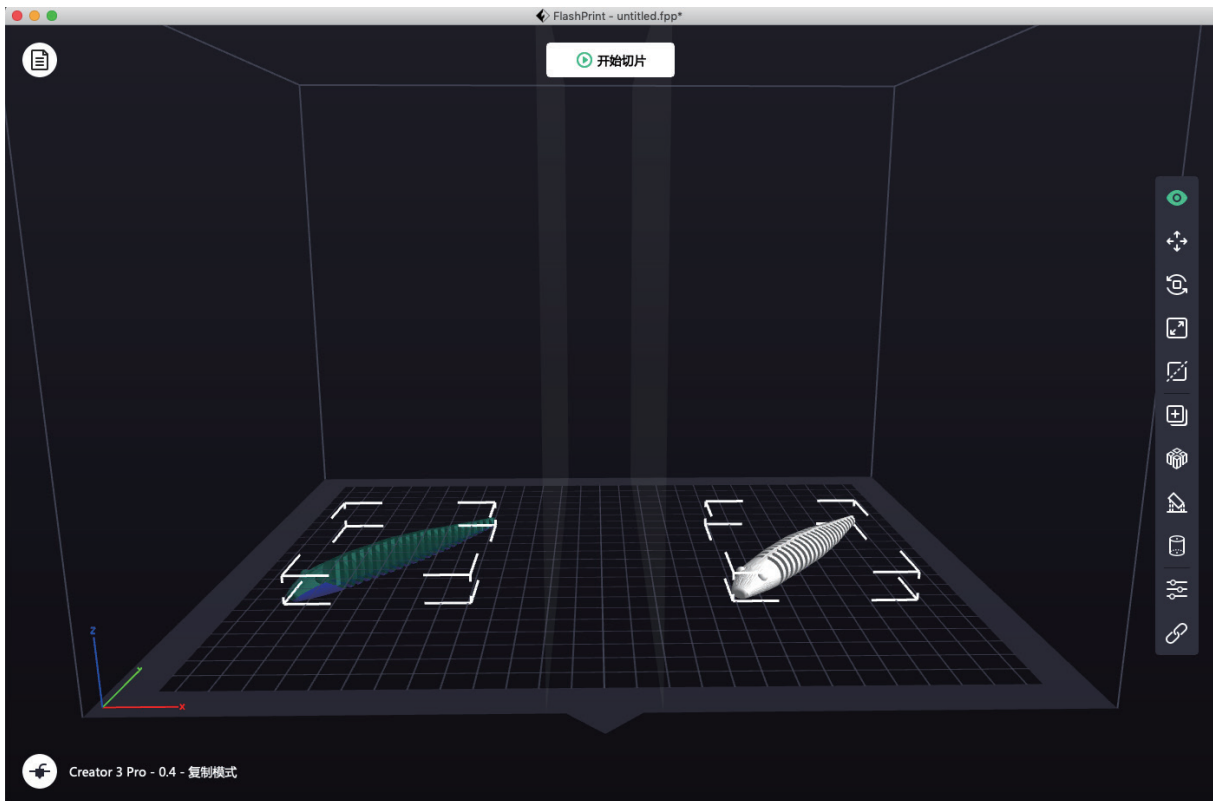

## 关于镜像与复制模式中的补偿层

**镜像与复制模式：** 由于左右喷头安装后高度不相同，因此切片时软件会自动增加补偿层以补偿高度差，使得左右两边打印高度一致。Z轴校准时以右喷头为基准，记录左右喷头的高度差。

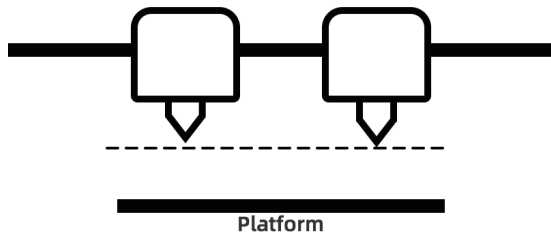

右喷头与平台距离小，左喷头打印补偿层。

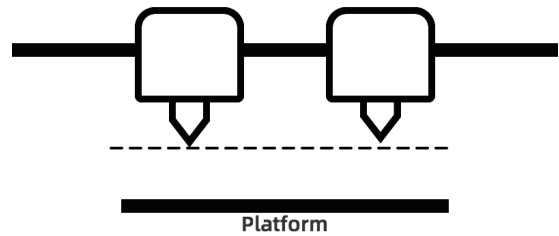

左喷头与平台距离小，右喷头打印补偿层。

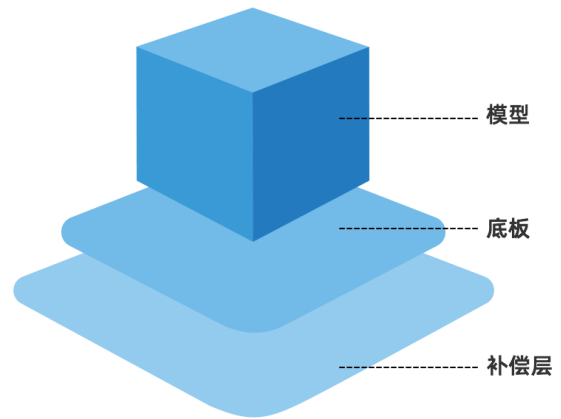
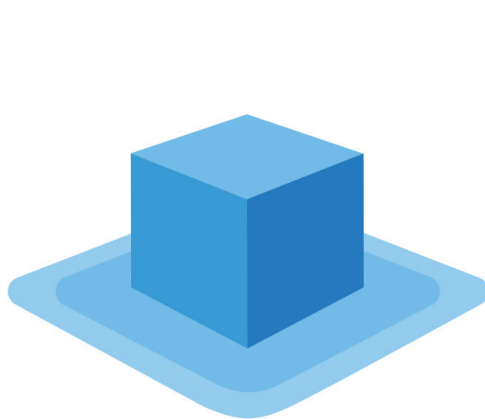

高度差小于0.2mm时，补偿层不打印。

补偿层被最先打印，与底板粘附在一起容易拆除。若不增加底板打印，补偿层将会被直接作用于模型，较难拆除。

## 5.3 材料配置

金刚狼3 Pro搭配两个独立喷头。可用于打印PLA、ABS、PETG、尼龙、PC、HIPS和PVA耗材。默认金刚狼3 Pro的左喷头打印支撑耗材。

独立双头挤出材料组合情况，请参见下表。

### 可溶性耗材组合：

左喷头	右喷头
PVA	PLA
PVA	NYLON
HIPS	ABS
HIPS	ASA
HIPS	PC
HIPS	PETG
HIPS	HIPS

PVA: 可溶解于水

HIPS: 可溶解于柠檬烯

### 非可溶性耗材组合：

左喷头	右喷头
PLA	PLA
ABS	ABS
ASA	ASA
PC	PC
PA	PA
PETG	PETG
PA-CF	PA-CF
PA-GF	PA-GF

注：金刚狼3 Pro可打印尼龙碳纤维，尼龙玻璃纤维。但由于喷嘴非高强度材料，将会对喷嘴造成磨损，预计打印1卷1kg尼龙碳纤维耗材需更换喷嘴。此情况可切换至高强喷嘴打印。

### PVA/PA耗材的存储

由于PVA耗材是水溶性的，有较强的吸水性。耗材吸水会软化，容易打印失败。打印时需将PVA耗材放置在干燥盒中。PA/PVA存储都需要密封干燥存储。

## 5.4 材料设置

为获得最佳效果，每种材料都需要不同的设置。

如果使用FlashPrint准备模型，在选择了正确的喷头和材料的情况下，这些设置将会自动正确设定好。

### 耗材参数的适配性

不同耗材品牌对应的材料特性有差异，因此使用金刚狼3 Pro时建议使用专家模式，对参数进行微调以确保更好的打印质量。

- 第一层高加厚，加大第一层出丝量有利于第一层的粘附；
- 打印PLA小模型（或环境温度高于25°C）时请设置45°C的底板温度；
- 打印PLA大模型（或环境温度低于10°C）时请设置70°C的底板温度；
- 使用PVA支撑时，建议支撑速度降低至40%。

对于金刚狼3 Pro支持的所有材料，建议在开始打印前在打印平台板上涂一层薄薄的胶（使用配件箱中的胶棒），这样可确保打印成品很好地附着在打印平台板上。

## 5.5 水溶性支撑材料的去除方式

使用PVA为支撑材料的模型需要一些后续处理，以去除PVA支撑材料。这可以通过将PVA溶解于水中的方式完成。

### 1、将模型浸泡水中

将带有PVA的模型放入水中，可让PVA缓慢溶解。您可以利用以下几种方法加快溶解过程：

- 使用较热的水可以减少溶解的时间。如果结构材料是PLA，请确保水的最高温度不超过35°C，以避免PLA变形。如果是尼龙，请确保水温勿超过50°C，以防止燃烧。
- 使用搅拌/流动的水可显著地减少溶解时间。当水流动时，PVA溶解得更快。
- 先将模型在水中浸泡约10分钟，之后可以用钳子去除大部分的支撑，再把模型放回水中，这样可以使PVA更容易溶解。

### 2、用水冲洗

在PVA支撑完全溶解后，用水冲洗模型以去除剩余的PVA。

### 3、晾干模型

让模型完全干燥，如有必要再对模型进行额外的后处理。

### 4、废水处理

由于PVA可生物降解，因此事后处置废水很容易。当废水管道和废水处理厂相连接时，废水可通过废水管道排出。处置废水过后，用热水冲洗排水管30秒，以去除排水管中多余的PVA，避免长期堵塞。

水可以重复用于浸泡多个模型，不过可能会增加溶解时间。因此建议使用新水以达到最快效果。

## 5.6 摄像头连接查看

在使用摄像头前，请取掉位于摄像头前部的盖子。

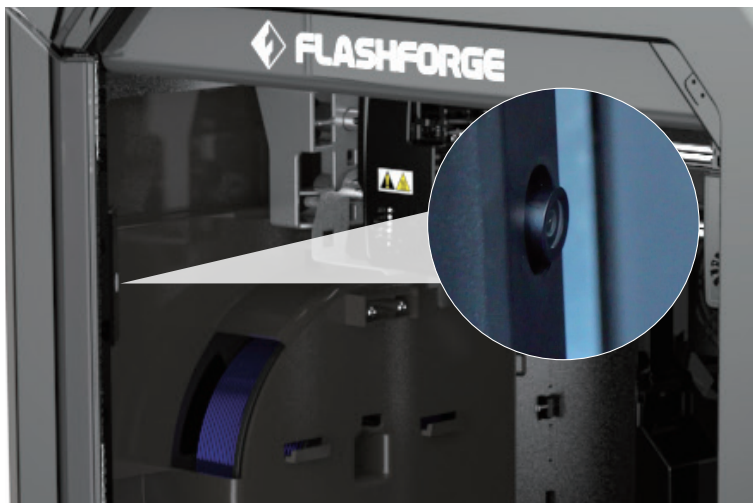

### · WLAN网络连接摄像头

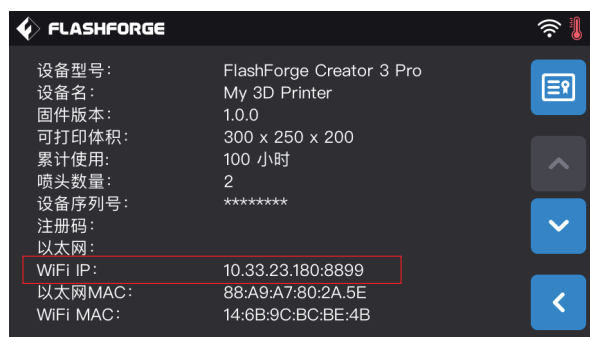
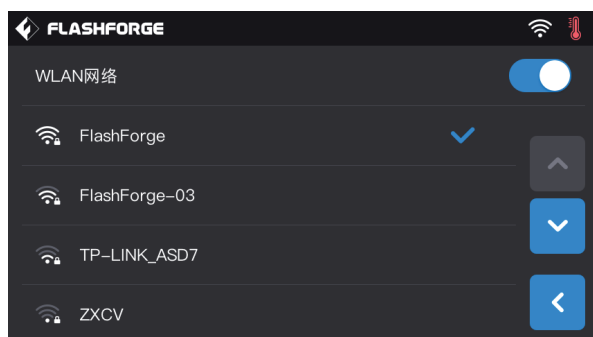

1、在设备触摸屏的主界面依次点击【工具】-【设置】-【WLAN网络】，开启WLAN网络连接按钮并连接网络。

2、在主界面依次点击【工具】-【设置】-【关于】，查询并记录设备WiFi IP地址：10.33.23.180（示例仅供参考，以本地获取的IP地址为准）

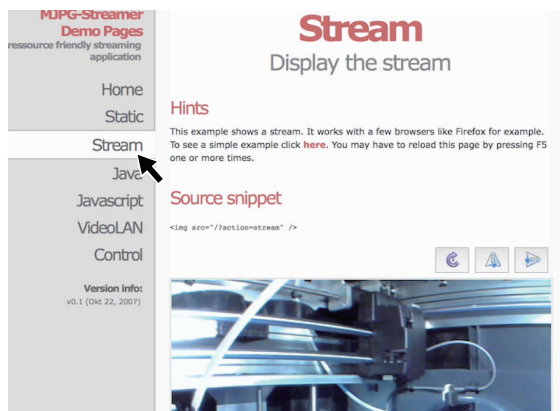

3、打开浏览器，输入并前往地址10.33.23.180:8080（示例仅供参考，以本地获取的IP地址为准），点击【Stream】即可查看金狼3 Pro内摄像头画面。

注：使用电脑、手机、平板电脑的浏览器打开【Stream】的结果是一致的。

# 第六章 设备操控界面简介

**⚠ 注意事项** 固件不定期升级，界面请以实际显示页面为准。以下仅为功能简介。

## 6.1 打印界面



点击【打印】，选择需要打印的模型

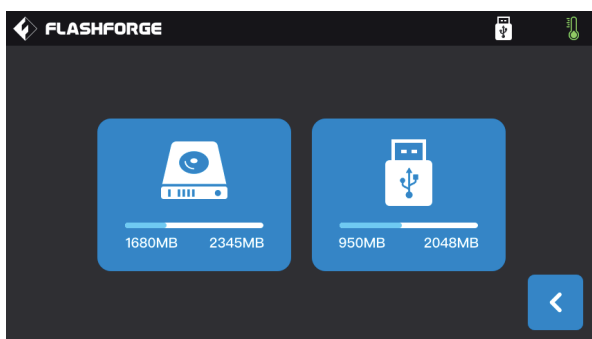

选择读取打印文件的路径

- 1、从打印机本地存储卡中读取；
- 2、从外接U盘中读取打印文件；



在文件列表中选择打印文件

- 1、打印：开始打印；
- 2、复制：将U盘中的文件复制到打印机本地存储卡（选择本地存储卡打印时此功能不可用）；
- 3、删除：删除此打印文件；



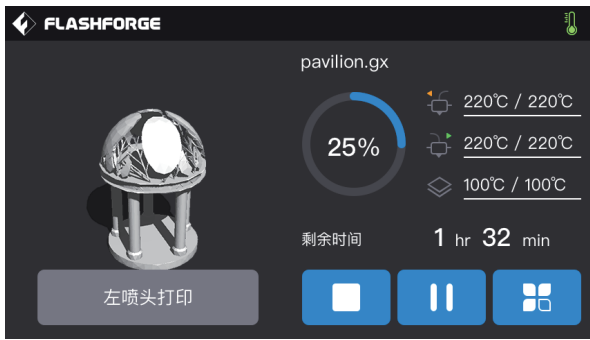

### 开始打印界面

- 1、停止：取消此次打印工作；
- 2、暂停/开始：暂停打印/开始打印；
- 3、更多：打印过程中可实时查询或更改：灯带状态、换丝设置、打印进度、打印速度、丝料使用量、打印时间和Z轴坐标；
- 4、左/右喷头温度、打印平台温度：打印过程中可进行修改；



### 修改左/右喷头温度和底板温度

喷头温度达到目标温度值，出现下划线后，点击喷头温度数值，选中数字框，通过点击“-”“+”修改设定喷头温度数值，点击【是】保存设定值；点击【否】取消设定。

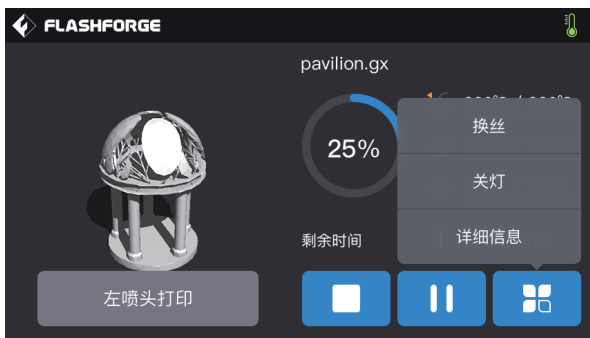

### 打印过程中点击更多按键

可实时查询或更改：换丝设置、关灯设置、打印详细信息（打印速度、丝料使用量、打印时间、Z轴坐标）。

- 1、换丝：打印中途需要换丝时可点击换丝按键（暂停打印后该功能可用）；
- 2、关灯：打印过程中可通过点击关灯按键实时打开或关闭灯带；
- 3、详细信息：
  - a、打印速度：打印过程中可点击设置打印速度数值；
  - b、丝料使用量：查看打印模型丝料使用量（单位：米）；
  - c、打印时间：查看打印时间；
  - d、Z轴坐标：查看Z轴坐标；
  - e、z轴补偿：修改第一层打印坐标位置；
  - f、返回：取消更多命令，返回打印界面；

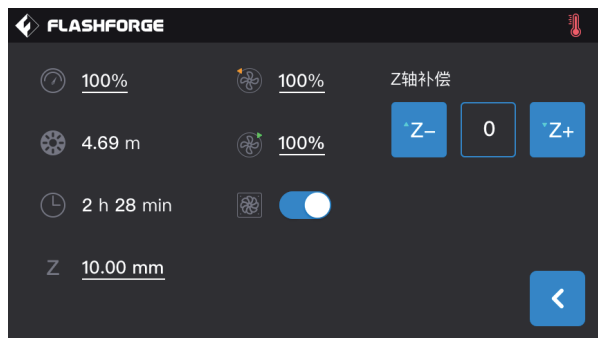

### 修改打印速度

开始打印后，点击打印速度数值，选中数字框，通过点击“-”“+”修改设定打印速度数值，点击是保存设定值；点击否取消设定。

## 6.2 工具界面

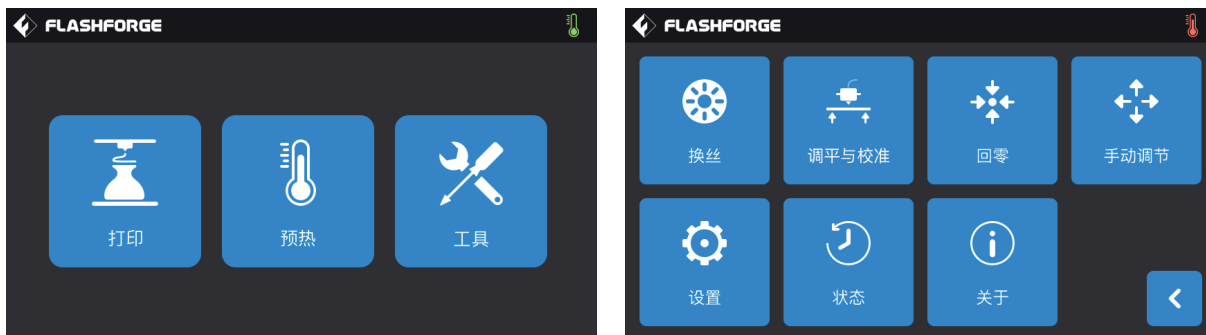

### 工具界面显示功能：

- 1、换丝：进行进/退丝操作；
- 2、调平与校准：校准喷头与平台值；
- 3、回零：使打印机的X/Y/Z轴回到机械原点；
- 4、手动调节：手动调节X/Y/Z轴的位置；
- 5、设置：对打印机进行相关的功能设置；
- 6、状态：查看打印机的实时状态；
- 7、关于：查看打印机的版本信息等。

## 6.3 设置界面

【工具】-【设置】 点击设置图标，进入设置界面。

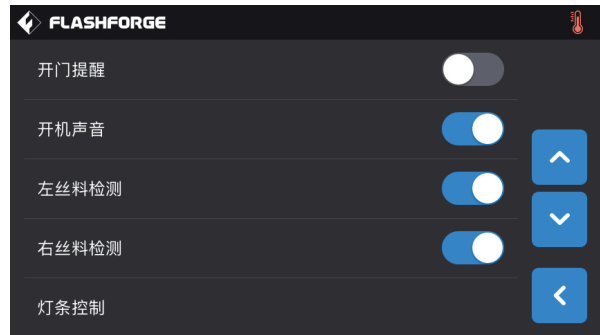
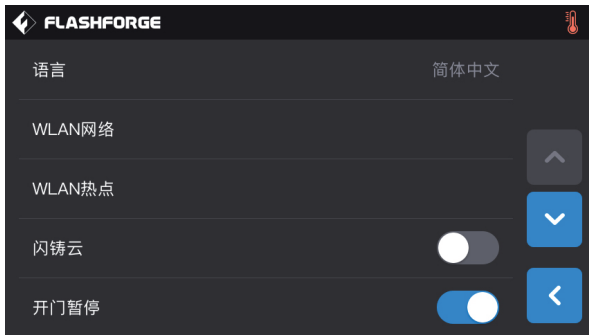

- 1、**语言**：设置打印机显示语言；
- 2、**WLAN网络**：关闭/开启网络连接；
- 3、**WLAN热点**：关闭/开启Wi-Fi热点；
- 4、**闪铸云**：关闭/开启云连接下载打印功能；
- 5、**开门暂停**：关闭/开启开门暂停；

- 6、**开门提醒**：关闭/开启开门提醒；
- 7、**开机声音**：打开/关闭机器开机声音；
- 8、**左丝盘检测**：打开/关闭左丝料检测功能；
- 9、**右丝盘检测**：打开/关闭右丝料检测功能；
- 10、**灯条控制**：打开/关闭机器内部灯条；

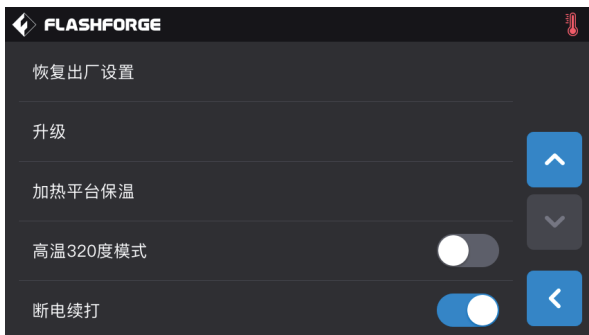



- 11、**恢复出厂设置**：回到出厂时的设置；
- 12、**升级**：预留更新功能；
- 13、**加热平台保温**：打印完成平台仍处于保温；
- 14、**高温320度模式**；
- 15、**断电续打**。

# 第七章 维护

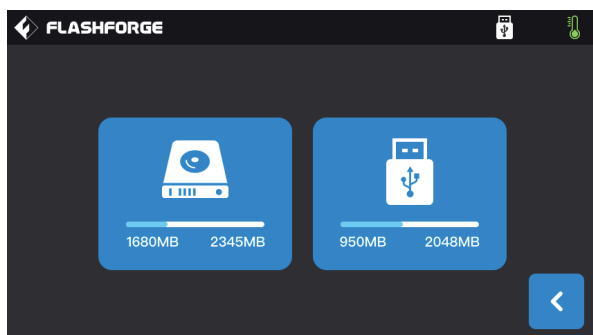
## 7.1 拷贝日志



- 1、插入U盘，在设备的触摸屏右上角会出现  图标。
- 2、点击  图标，等待10秒，拔掉U盘。
- 3、把U盘插入电脑，打开U盘文件夹找到 log文件。
- 4、请把日志文件发给闪铸客服。

## 7.2 维护与检修

问题	原因	改正措施
喷头偏离中心。	设备以遗失喷头的精确位置轨迹无法正确打印。	取下模型，清理干净打印平台，将喷头送回原始位置，重新校准。再打印新的模型。
耗材未能正确挤出或粘附在打印平台上。	可能是打印平台未调平，与喷头间距不一致。	重新调平。
模型开始打印之前设备无响应。	设备可能接收到了相互矛盾的命令。	关闭电源开关，等待30秒，然后打开电源开关。
打印结束时，耗材成块附着在喷嘴上；或耗材呈丝状散落在打印机内。	模型某层未能正确粘附，保存模型时采用了接触打印平台的最小表面积；或模型打印时未选择支撑，悬浮于打印平台上方。	重新对模型进行切片，如有必要增加支撑。
模型只打印了一半。	打印耗材耗尽。 打印期间喷头堵头。	更换打印哈耗材，开启丝料检测功能，继续打印；参见下面的“打印耗材无法挤出”。
打印耗材无法挤出。	喷头堵头。	使用通针在进丝状态下推动耗材。 联系客服。
喷头无法回到原位。	限位开关线路故障。	联系客服。
在陡峭的突出部分，模型表面呈细长稀疏或有磨损。	模型突出太远或太抖（小于45度角）。	使用支撑打印。

## 7.3 疏通喷嘴

- 1、点击【预热】，设置加温温度，轻点返回键。
- 2、点击【工具】-【换丝】-目标喷头【进丝】，等待喷头加热升温至屏幕提示进丝，将通针插入喷头入口（顶部）。
- 3、将阻塞的残渣推下去，并从喷嘴挤出。若遇到一定阻力，可以向下用力。注意，不要使用蛮力，若尝试几次，用力疏通无果，需要更换喷嘴或联系售后客服。

## 7.4 如何更换喷嘴组件

请在关机状态下操作：

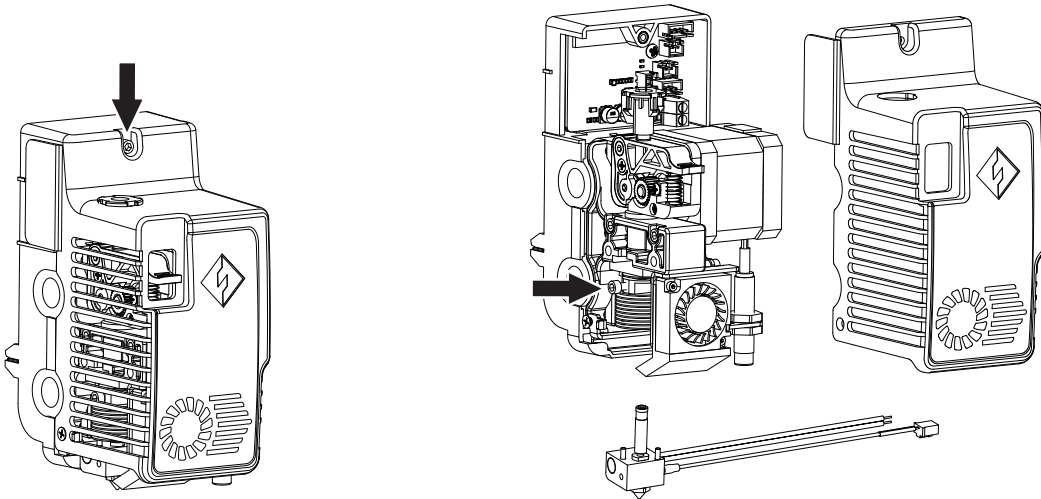

1. 使用内六角螺丝刀拧开螺丝，取下喷头外罩；
2. 拧开此处的螺丝，拔出加热管线束以及热电偶的线束；
3. 换上新的喷嘴组件。请务必将喷嘴组件顶到底为止，不可以存在安装间隙。拧紧对应螺丝；将线束插入到喷头电路板中；盖上外壳并锁紧螺丝。

## 7.5 防溢丝板

防溢丝板由于经过厂内检测，可能存在局部划痕，属于正常现象。随着打印的不断使用，划痕会更加明显，但不会影响喷嘴的使用，可手动调节防溢丝板与喷嘴的距离。请确保使用时喷嘴始终能接触到防溢丝板。若划痕较深，可根据实际情况做更换。

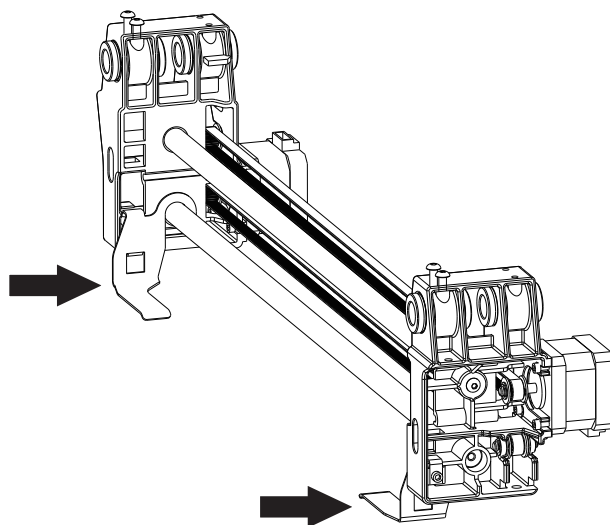

## 7.6 日常保养及使用建议

- 1、日常不使用设备期间，请盖上顶盖，关闭前门，避免设备落灰。长期未使用者，建议使用原厂包装封存。
- 2、定期给运动部件上润滑油（脂）。使用频繁者，至少每三个月添加一次润滑油（脂）；长期不使用者，至少每半年添加一次润滑油（脂）。
- 3、每次打印结束，请及时清理打印内腔的耗材残渣和其他杂物，避免细小杂物掉入底部电路板中，影响设备使用。
- 4、打印贴纸为消耗品，当打印平台贴纸附着力下降，甚至破损；请及时更换打印贴纸。以免影响打印效果。
- 5、首次使用设备或更换打印耗材后，应使用闪铸官方耗材，直到喷嘴挤出耗材与装入耗材颜色一致。
- 6、无论何时，建议将模型至于打印平台的中心位置。可以在切片软件中设置模型摆放位置。
- 7、对于陡峭的凸出部分（小于45度角），建议使用支撑打印。

## 第八章 帮助与支持

闪铸专业的售后服务人员及业务员随时为您待命，非常乐意为您解决在您使用过程中遇到的任何问题。如果您无法从用户手册中找到答案，您可以进入我们的官方网站来搜索问题的解决方案，或者通过电话联系我们。

在我们的官网中可以找到一些常见问题的说明和解决方法。您的许多问题都可以在闪铸科技中文官方网站[www.sz3dp.com](http://www.sz3dp.com)得到解决。

您可以在周一到周六上午8:00到下午5:00通过电话来联系闪铸售后团队，为您解决问题。如果您在下班时间联系我们，闪铸将在下一个工作日的第一时间给您反馈。若造成不便，我们万分抱歉。

提示：由于更换不同的丝料，会有少量杂质残留在喷头中造成喷头堵塞，疏通后即可，不属于质量问题。若用户使用时存在该问题，请联系售后，并在售后的指导下完成疏通工作。

售后服务热线：400-886-6023

邮箱：[support@flashforge.com](mailto:support@flashforge.com)

公司地址：浙江省金华市婺城区仙源路518号

提示：联系售后时，请提供产品序列号，即打印机背部的条形码





Follow us

**Zhejiang Flashforge 3D Technology Co., Ltd.**

Address: No.518 XianYuan Road, Jinhua City,Zhejiang Province, China

Service Hotline: +86 579 82273989

[support@flashforge.com](mailto:support@flashforge.com)