

BlueAnt

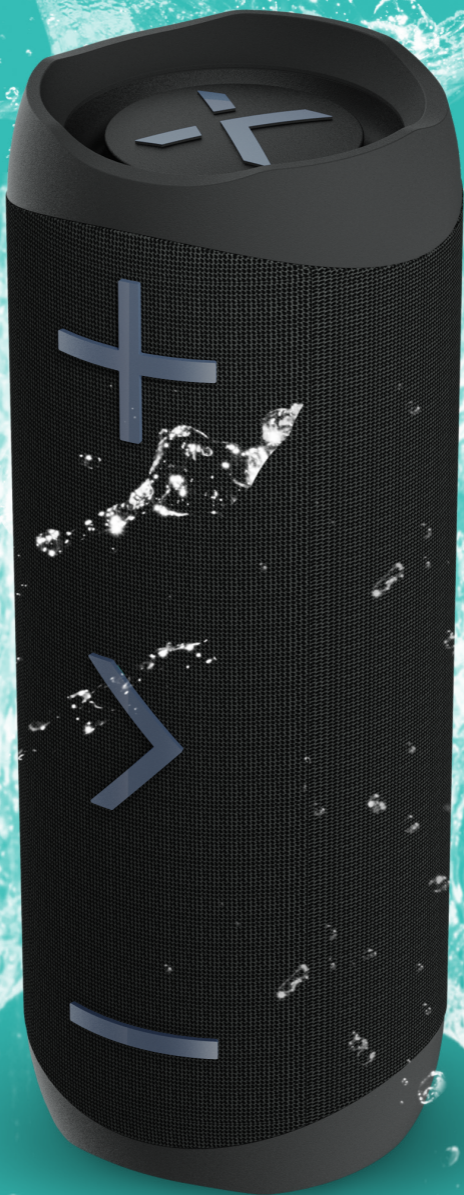

X-3D MAX
40 Watt Bluetooth Speaker

User Manual



Welcome

You've just unlocked a world of awesome with your X3D MAX purchase. Please read through this manual to unleash the full magic of your speaker. Let the fun begin!

Inside the box

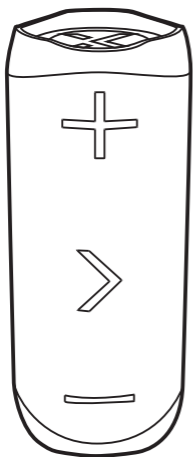

**BlueAnt X3D MAX
Speaker**



User Manual

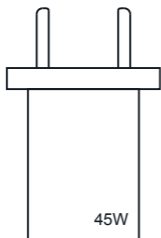

Fast Charger

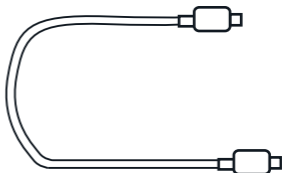

**USB-C to USB-C
Fast Charge Cable**

The X3D MAX is capable of very high volume output. For Continuous Play, please use the supplied Fast Charger and Fast Charging Cable for endless uninterrupted audio.

Get to know your X3D MAX Speaker

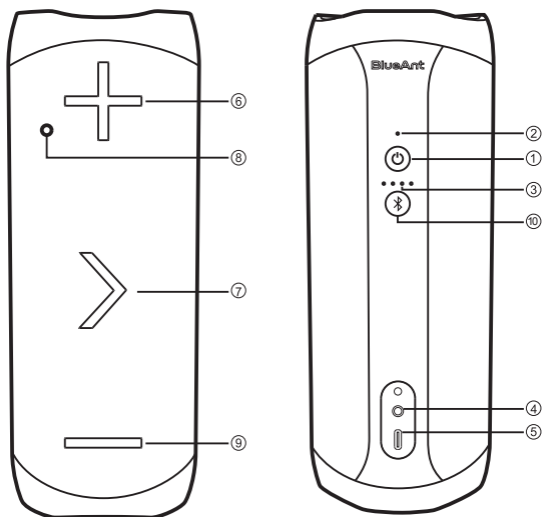

Item	Button	Function
1		<i>Power Button</i> - Press for 1.5 seconds to power on Press for 1.5 seconds to turn off
2		Bluetooth Indicator
3		Battery Indicator
4		AUX in Jack 3.5mm
5		USB-C Charge Port - USB-C to USB-C cable supplied
6		<i>Volume Up</i> - Click or press and hold
7		<i>Click to Play/Pause</i> <i>Double Click to skip forward a track</i> <i>Click to Answer/End a Call</i> <i>Double Click or press and hold to reject a call</i>
8		Microphone
9		<i>Volume Down</i> - Click or press and hold
10		Press for 1.5 seconds to disconnect Bluetooth

Let's Get Started

Charging the X3D MAX

Please use the supplied USB-C to USB-C Fast charge cable and Fast charger to charge the X3D MAX. A full charge will take around 4 hours. Please close the port cover after you have charged the speaker.

WATERPROOF - The X3D MAX features waterproof IP67 rating. The speaker is only waterproof when the port cover is closed.



Power ON/OFF

1. Press and hold the power button  for 1.5 seconds to power the speaker *ON* or *OFF*.



Each time the speaker powers on, it will reset to 25% volume. After 10 minutes with no connection, the speaker will automatically power OFF to conserve battery.

MODES

A) Bluetooth Mode - Pairing the speaker to your phone or device



1. Power *ON*  the speaker and press  button to go into Bluetooth pairing. The light indicator will flash.
2. On your phone or device, look for "BlueAnt X3D MAX" under the Bluetooth settings menu. Click on "BlueAnt X3D MAX" on your phone.
3. Once paired, the speaker will say "Connected" and the LED display will stop flashing. You are now ready to play some music!

B) Using the buttons for playing music

	Click or press and hold to increase volume
	Click to Play/Pause Double click to skip forward a track
	Click or press and hold to decrease volume

Let's Get Started cont'd...

C) Calls

	Click to answer an incoming call
	Click to end the active call
	Click and hold or double click to Reject Call



D) Disconnect

	Press and hold the Bluetooth button for 1.5 seconds to disconnect the current Bluetooth connection. The speaker will prompt, "Disconnected". Then other Bluetooth devices can find and pair with the speaker.
--	---

F) Duo Mode

Duo Mode Connection

The BlueAnt X3D MAX can be paired to another X3D MAX or an X3D in Duo Mode.

1. Press the power  button on the *PRIMARY* speaker, to turn the speaker on.
2. Then on the *PRIMARY* speaker, press and hold *Volume +* & *Volume -* for 1.5 seconds, until the speaker says, "Duo Mode pairing". Then release the button.
3. Press the power  button on the *SECONDARY* speaker, to turn the speaker on.
4. Then on the *SECONDARY* speaker, press and hold *Volume +* & *Volume -* for 1.5 seconds, until the speaker says, "Duo Mode pairing". Then release the button.
5. Please wait until one speaker says, "Duo Mode Connected". This may take up to 1 minute. The speakers are now connected to each other.

Let's Get Started cont'd...

For Bluetooth pairing, search for "BlueAnt X3D MAX" on your smartphone. If you receive a call while in Duo Mode, the call will only come through the PRIMARY speaker.

When in *Duo Mode* and you power off one speaker, BOTH speakers will power off. When you power on the speakers, they need to be turned on individually.

When you power on the *SECONDARY* speaker, if it had previously been connected in Duo mode, it will reconnect to the *PRIMARY* speaker.

Duo Mode Disconnection



To disconnect *Duo Mode*, press and hold *Volume +* & *Volume -* for 3 seconds on the *SECONDARY* speaker until the speaker says, "Duo Mode Disconnected". The speaker will then say, "Duo Mode Cleared".

This means the *SECONDARY* speaker will no longer automatically reconnect to the *PRIMARY* speaker when it powers on.

Assuming direct line of sight, you should be able to achieve a range of over 30 metres between the speakers. When used indoors, the range will be affected by internal walls or obstacles between the speakers.

AUX In Mode

Use 3.5mm audio cable to connect the speaker to an audio source (PC, MP3/MP4, mobile phone). When you plug the AUX cable into the speaker, it will automatically change to *AUX In Mode*. When you unplug the AUX cable, the speaker will change to Bluetooth mode. The speaker will play the music from the audio source.

	Click or press and hold to increase volume
	Click to mute/unmute play back
	Click to press and hold to decrease volume

To change or control tracks, please use your music source when in *AUX In Mode*.

Duo Mode



X3D MAX
with another
X3D MAX



Duo Mode

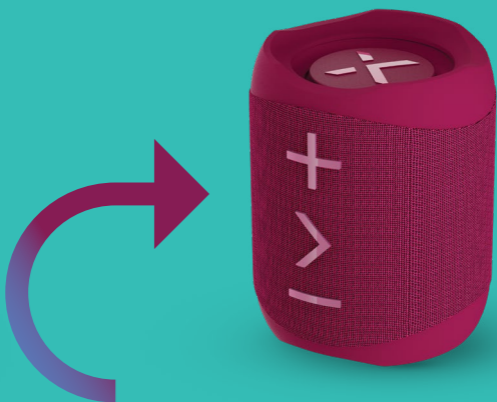

X3D MAX
with an X3D



SAFETY INFORMATION & WARRANTY TERMS

Important Safety Information

**PLEASE READ THIS ENTIRE DOCUMENT CAREFULLY,
BECAUSE IT CONTAINS IMPORTANT INFORMATION
ABOUT THE USE OF BLUEANT DEVICES**

WARNING - PROTECT YOUR HEARING

**BLUEANT DEVICES CAN REACH VOLUMES
ABOVE 100 DECIBELS**

ONLY CHARGE WHEN DEVICE IS CLEAN AND DRY

Care and Handling

Your BlueAnt Bluetooth device is a precision engineered instrument. To ensure its ongoing performance, you should look after it as you would any quality consumer electronic product, and use it in accordance with the instructions. BlueAnt recommends that you take the following precautions. Avoid leaving your device in direct sunlight.

- Do not leave your device, or use your device, in any area where the temperature may exceed 45 degrees Centigrade, such as inside a closed car on a hot day. Remember that on a hot day, the temperature inside a closed car may be significantly higher than the outside air temperature.
- Do not leave your device, or use your device, in any area where the temperature is likely to drop below 0 degrees Centigrade (32 degrees Fahrenheit).
- Do not leave your device, or use your device, in any area exposed to humidity, dust, soot, other foreign objects, smoke, or steam as this may cause your device to malfunction.

**PROLONGED USE AT HIGH VOLUMES MAY
AFFECT YOUR HEARING CAPACITY AND MAY
RESULT IN NOISE INDUCED HEARING LOSS
(NIHL). TURN OFF THE POWER TO YOUR
DEVICE WHEN NOT IN USE.**

- Do not use any household or industrial grade detergents or cleaners to clean your device. If your device becomes dirty or smeared, in most instances a wipe with a dry or slightly damp cloth should be sufficient to clean it.
- Before charging your BlueAnt device, make sure that the AC outlet, adaptor and cable are not damaged. If you notice any abnormalities, seek advice from a qualified professional.
- If travelling internationally, ensure that your BlueAnt wall or car power adapter is approved for use in the country where you plan to use it and that the adapter voltage is suited to the local power supply.
- Should a fault develop with your BlueAnt product, contact BlueAnt for advice on how to proceed. Do not attempt to repair or alter any BlueAnt product yourself.

THANK YOU FOR CHOOSING A BLUEANT PRODUCT

Register your BlueAnt product for warranty and
new product updates at:

register.blueantwireless.com

Approved Accessories

The use of accessories not approved by BlueAnt, including but not limited to batteries, antennas, wall adapters, car charger, ear gels and foam tips and convertible covers, may cause your BlueAnt device to malfunction or in the case of non approved electrical accessories may cause the device to exceed RF energy exposure guidelines.

Electromagnetic Interference

Nearly every electronic device is susceptible to electromagnetic interference (EMI) if inadequately shielded, electromagnetic configured for electromagnetic compatibility. Similar to a mobile phone, your BlueAnt device is a low power transmitter/receiver and is covered by regulations pertaining to such devices. Turn off your BlueAnt device in any facility where posted notices instruct you to do so. These facilities may include hospitals or health care facilities that may be using equipment that is sensitive to external RF energy.

- When instructed to do so, turn off your BlueAnt device when on board an aircraft. Any use of a mobile device must be in accordance with applicable laws, regulations and airline crew instructions.
- If you use any other personal medical device, consult the manufacturer of your device to determine if it is adequately shielded from RF energy. Your doctor or physician may be able to assist you in obtaining this information.
- If you are in doubt about whether your BlueAnt device can be safely turned on or used, please consult an authorised person in the location you want to use your BlueAnt device. If no authorised person is available or you remain uncertain, BlueAnt recommends that you turn off your Bluetooth device and any mobile phones unless they are required in an emergency situation.

Recycling Bluetooth Accessories

Do not dispose of Bluetooth accessories, such as chargers, speakers, headphones or headsets with your household waste. In some countries or regions, collection systems are set up to handle electrical and electronic waste items, and may prohibit or restrict how such items are disposed of. Check the laws and regulations for your areas to determine how to properly dispose of such items.

BlueAnt Limited Global Warranty

This product is covered by BlueAnt's limited global warranty for one (1) year from the date of purchase by the first consumer purchaser of the product. Please refer to warranty.blueantwireless.com for full terms and conditions.

For warranty and technical support, please email care@blueantwireless.com or head over to our website www.blueantwireless.com

Australian Consumer Law

Our goods come with guarantees that cannot be excluded under the Australian Consumer Law. You are entitled to a replacement or refund for a major failure and compensation for any other reasonably foreseeable loss or damage. You are also entitled to have the goods repaired or replaced if goods fail to be of acceptable quality and the failure does not amount to a major failure.

BlueAnt Wireless

Suite 6, 861 Doncaster Road
Doncaster, Vic, 3109 Australia

BlueAnt



REGISTER & SCAN

Register your BlueAnt product for warranty and new product updates by scanning the QR Code above

Visit support.blueantwireless.com or email: care@blueantwireless.com

100% AUSTRALIAN
DESIGNED & OWNED



blueantwireless.com