



0-10V to DALI Converter

Datasheet Interface

Module for the control of a DALI-
line with analogue 0-10V signals

- Art. Nr. 86468353-1-HS (1 channel)
- Art. Nr. 86468353-2-HS (2 channels)
- Art. Nr. 86468353-3-HS (3 channels)

0-10V to DALI Converter Interface

Overview

- Small interface module for the conversion of 0-10V control signals to DALI dim levels
- Devices with 1, 2 and 3 channels available
- The 0-10V voltage is transformed to a DALI dim level and DALI-command Off and sent to the defined effective range on the DALI line
- A change on the 0-10V input voltage (<1%) is used as event trigger
- Supply voltage 12V to 24V DC (e.g. 24V/300mA Art.Nr. 24166012-24HS), multiple devices can be supplied by the same supply voltage
- Configuration of effective range and conversion characteristic (conversion curve and behaviour below 1V input voltage) via DALI-Cockpit and DALI-USB-interface
- Passive input: the module does not supply any voltage to the input, suitable for control with a 0-10V analogue signal (e.g. Siemens LOGO)
- External DALI power supply (e.g. DALI PS) required, multiple devices can be connected to the same DALI-line
- **Galvanic isolation between DALI-Bus and 0-10V input respectively 24V-supply voltage**

Specification, Characteristics

Type	0-10V to DALI Converter		
article number	86468353-1-HS	86468353-2-HS	86468353-3-HS

Electrical data:			
supply	12V-24V DC		
typ. input current 24V	5mA		
input	1x 0-10V / 0,1mA	2x 0-10V / 0,1mA	3x 0-10V / 0,1mA
output	DALI		
Function	converter, function configurable via DALI		

Technical data:	
storing and transportation temperature	-20°C ... +75°C
operating ambient temperature	-20°C ...+75°C
protection class	IP20
connecting wire cross section	up to 2.5 mm ²
mounting	Din rail
dimensions	1TE, 98mm x 17.5mm x 56mm

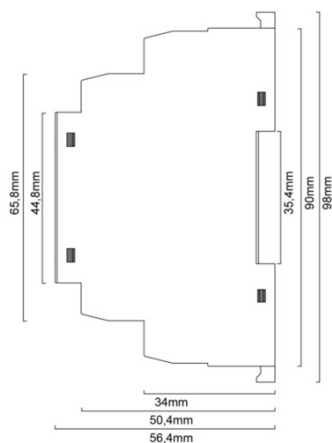

dimensions

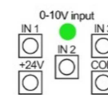
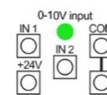
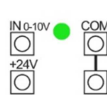
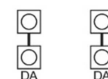

connection plan
1 channel

connection plan
2 channel

connection plan
3 channel

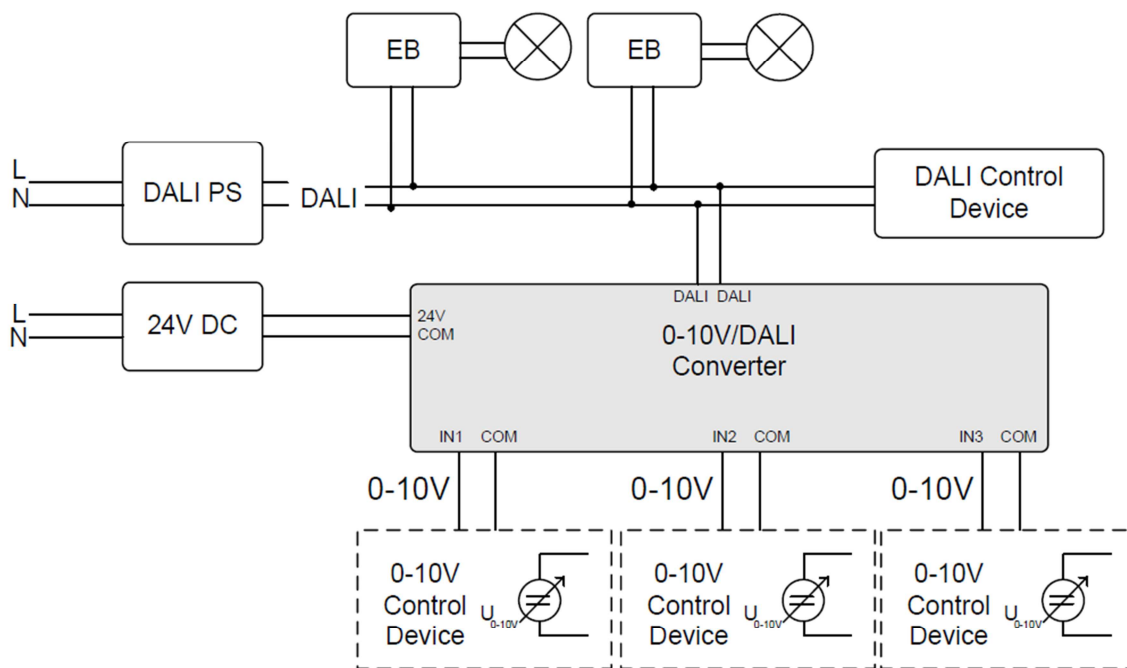

typical installation 3channel 0-10V to DALI converter

Installation

- Supply: 12V-24V DC (e.g.. 24V/300mA Art.Nr.: 24166012-24HS)
- Galvanic isolation between DALI and 0-10V input / supply
- The 0-10V input voltage has same potential as the supply voltage
- the connection to the DALI-line is polarity free, the DALI-line is powered by an external DALI power supply

Default Settings and Configuration

- After connecting the device it is ready to use, dependent on the type different factory default settings apply:

Type	1 channel (86468353-1-HS)	2 channel (86468353-2-HS)	3 channel (86468353-3-HS)
Effective Range	Broadcast	channel1: G0 channel2: G1	channel1: G0 channel2: G1 channel3: G2
Dimming range	1%-100%		
Behaviour for input voltage below 1V	OFF		
Fade Time	0.7s		

- Changes on the default settings can be done with the help of the DALI-Cockpit:

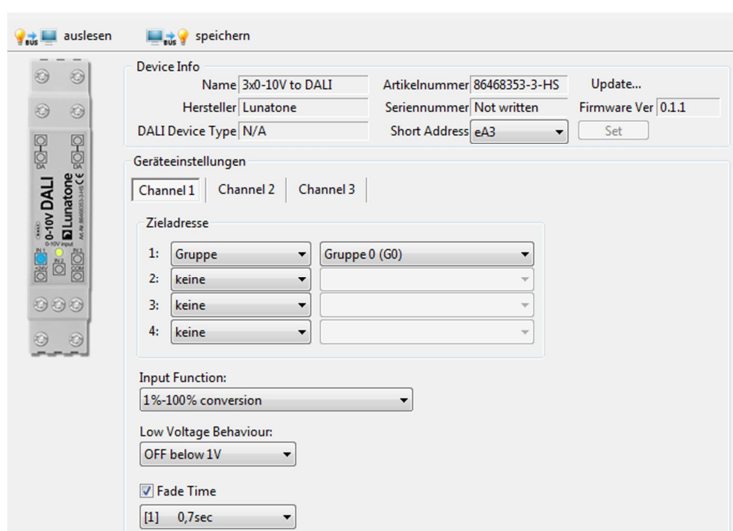

0-10V / DALI conversion

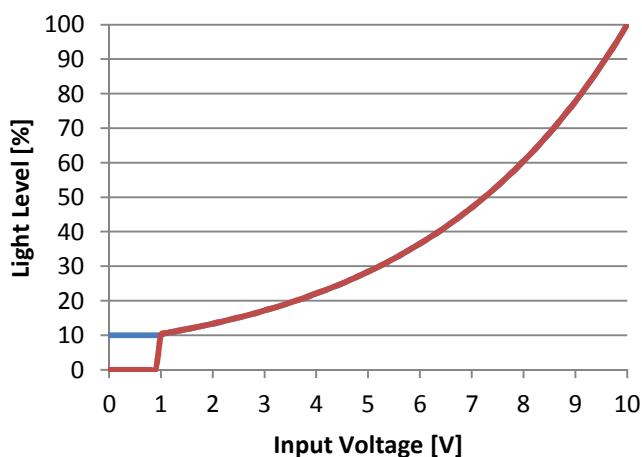

Light level of a DALI-ballast connected to the converter (corresponding to IEC62386-102).

conversion characteristic:

The input voltage in the range of 1V-10V is converted into DALI dim levels.

In the DALI-Cockpit the following parameters can be changed:

Light Level Range:

0.1%-100%, 1%-100% or 10%-100%

On/Off-Behaviour:

the behaviour below 1V input voltage: DALI-command OFF or RECALL MIN

On the left the characteristic with 10%-100% dimming range is shown as an example.

Purchase Order Information

Art. Nr.: 86468353-1-HS: 1 channel 0-10V to DALI Konverter, conversion of a 0-10V analog voltage to a DALI dim level, input passive, 24V DC supply, input and supply electrically isolated to DALI-line, suitable for external DALI power supply, din rail

Art. Nr.: 86468353-2-HS: 2 channel 0-10V to DALI Konverter, conversion of a 0-10V analog voltage to a DALI dim level, input passive, 24V DC supply, input and supply electrically isolated to DALI-line, suitable for external DALI power supply, din rail

Art. Nr.: 86468353-3-HS: 3 channel 0-10V to DALI Konverter, conversion of a 0-10V analog voltage to a DALI dim level, input passive, 24V DC supply, input and supply electrically isolated to DALI-line, suitable for external DALI power supply, din rail

Art. Nr.: 24166012-24HS, 24VDC/300mA power supply, dinrail, 1TE

Additional Information and Equipment

DALI-Cockpit – free configuration tool from Lunatone for DALI systems

<http://lunatone.at/de/dali-systeme/software/>

Lunatone DALI products

<http://www.lunatone.at/de/>

Lunatone datasheets and manuals

<http://lunatone.at/de/downloads/>

Contact

Technical Support: support@lunatone.com

Requests: sales@lunatone.com

www.lunatone.com



Disclaimer

Subject to change. Information provided without guarantee.
The datasheet refers to the current delivery.

The compatibility with other devices must be tested in advance to the installation.