

CQH SERIES CONNECTOR

The CQH Series are designed for high-purity use and feature all plastic construction. Molded, virgin materials and lubricant-free design enable use in the most demanding applications. Broad chemical compatibility and cleanroom manufacturing make them ideal for use in critical wet processes.



SPECIFICATIONS

CQH PRESSURE: 0 - 80 psig (0 - 5.5 bar)

CQH TEMPERATURE:
32°F to 225°F (0°C to 107°C)

CQH MATERIALS:

Main components: Natural, virgin polypropylene

Valve o-rings: FKM (black)

External insert o-ring:
Simriz® FFKM perfluoro (black)

Valve (wetted) and thumb latch spring:
PEEK®

Flare nuts: PVDF

Lubricants: None used

SPILLAGE/AIR INCLUSION:

~1.5 cc (ml)/disconnect (reconnect)

Note: CQH are also available with optional PPS springs and Chemraz FFKM or EPDM seals.



cpcworldwide.com/CQH

FEATURES

- 100% metal free → No risk of metal contaminants or corrosion
- High flow valve design → High flow in a compact package
- Disconnect under pressure → Speeds servicing and reduces risk of injury
- Polypropylene and PVDF → Broad chemical compatibility

BENEFITS

NOTE

See page 139 for ChemQuik Dual Containment Nut options.

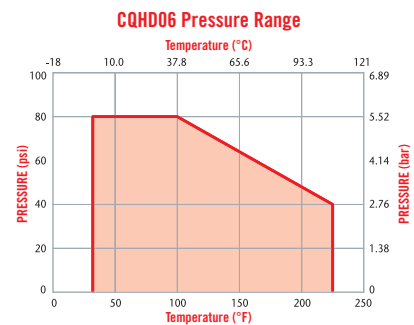
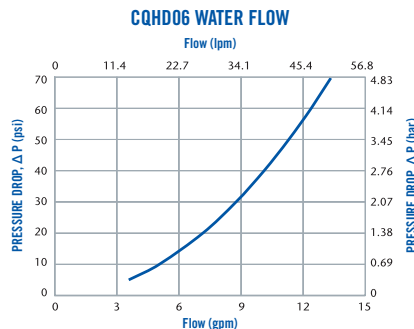

These graphs are intended to give you a general idea of the performance capabilities of each product line. The shaded area of each graph represents the operating range of the product family, i.e., upper and lower values are shown. Therefore, depending on the exact coupling configurations selected, you can reasonably expect values to fall within the shaded area.





COLDER PRODUCTS COMPANY
U.S.A.
PHONE: +1 (651) 645-0091
FAX: +1 (651) 645-5404
TOLL FREE: +1 (800) 444-2474
E-MAIL: info@cpcworldwide.com

COLDER PRODUCTS COMPANY GMBH
Germany
E-MAIL: cpcgmbh@cpcworldwide.com

DOVER (SHANGHAI) INDUSTRIAL CO., LTD
ShangHai, China
PHONE: +86 21 2411 2666
TOLL FREE: +86 400 990 1978
E-MAIL: asiapacific@cpcworldwide.com

CQH SERIES DIMENSIONS

COUPLING BODIES - Polypropylene

TERMINATION	TUBING/THREAD SIZE	TERMINATION TYPE	SHUTOFF	A	B	C
 IN-LINE	3/8" OD	Flare compression	CQHD06100106	1.44 (36.6)	3.38 (85.9)	
 PANEL MOUNT	3/8" Taper	Male NPT	CQHD06110206	1.82 (46.2)	2.73 (69.3)	1 (25.4)

COUPLING INSERTS - Polypropylene

TERMINATION	TUBING/THREAD SIZE	TERMINATION TYPE	SHUTOFF	A	B	C
 IN-LINE	3/8" OD	Flare compression	CQHD06200106	1 (25.4)	2.55 (64.8)	1 (25.4)
	3/8" Taper	Male NPT	CQHD06200206	1.16 (29.5)	1.9 (48.3)	1 (25.4)

All measurements are in inches (millimeters) unless otherwise noted. Tubing must meet stated inside and outside diameters.

PRODUCT DIMENSIONS

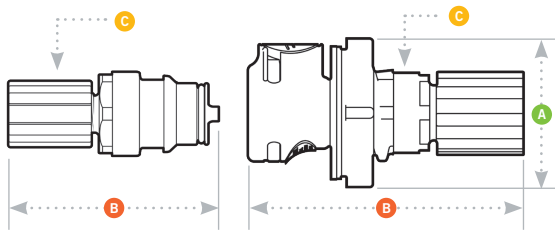

- A = Height/Diameter
- B = Total Length
- C = Hose Barb Length

PANEL DIMENSIONS

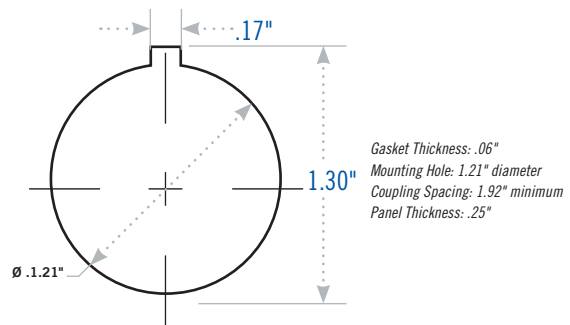

	PANEL OPENING	PANEL THICKNESS MAX.-MIN.
COUPLING BODIES	see drawing	.25 - .03

WARRANTY: All sales are subject to Colder Products Company's limited express warranty set forth in the CPC catalog. Contact your local distributor or CPC Customer Service for warranty provisions.

Warning: Due to the wide variety of possible fluid media and operating conditions, unintended consequences may result from the use of this product, all of which are beyond the control of CPC. It is the user's responsibility to carefully determine and test for compatibility for use with their application. All such risks shall be assumed by the buyer.

COPYRIGHT © 2021 BY COLDER PRODUCTS COMPANY. COLDER PRODUCTS COMPANY, COLDER PRODUCTS AND CPC ARE REGISTERED

TRADEMARKS WITH THE US PATENT & TRADEMARK OFFICE