

Korlite VAPOR TIGHT LED LIGHT FIXTURE INSTALLATION INSTRUCTION

Upon receiving the fixture, thoroughly inspect for any freight damage. All damage should be reported to the delivery carrier. Compare the catalog description listed on the packing slip with the fixture label on the inside of the housing to be sure you have received the correct merchandise.

Please read this manual carefully before using the product

READ AND FOLLOW THESE SAFETY INSTRUCTIONS!

- ▶ To reduce the risk of death, personal injury or property damage from fire, electric shock, falling parts, cuts/abrasions, and other hazards please read all warnings and instructions included with and on the fixture box and all fixture labels.
- ▶ Before installing, servicing, or performing routine maintenance on this equipment, follow these general precautions.
- ▶ Commercial Installation: Service and maintenance of luminaires should be performed by a qualified licensed electrician.
- ▶ Residential Installation: If you are unsure about the installation or maintenance of the luminaires, consult a qualified licensed electrician and check your local electrical code.
- ▶ Maintenance of the luminaires should be performed by person(s) familiar with the luminaires' construction and operation and any hazards involved. Regular fixture maintenance programs are recommended.
- ▶ This fixture is intended to be connected to a properly installed and grounded UL listed junction box.
- ▶ It will occasionally be necessary to clean the outside of the refractor/lens. Refractor/lens should be washed in a solution of warm water and any mild, non-abrasive household detergent, rinsed with clean water and wiped dry. Should optical assembly become dirty on the inside, wipe refractor/lens and clean in above manner, replacing damaged gaskets as necessary.
- ▶ DO NOT INSTALL DAMAGED PRODUCT! This luminaire has been properly packed so that no parts should have been damaged during transit. Inspect to confirm.
- ▶ Any part damaged or broken during or after assembly should be replaced.
- ▶ These instructions do not purport to cover all details or variations in equipment nor to provide every possible contingency to meet in connection with installation, operation, or maintenance. Should further information be desired or should particular problems arise which are not covered sufficiently for the purchaser's or owner's purposes, this matter should be referred to manufacturer.

WARNING RISK OF ELECTRIC SHOCK

- ▶ Disconnect or turn off power before installation or servicing.
- ▶ Verify that supply voltage is correct by comparing it with the luminaire label information.
- ▶ Make all electrical and grounded connections in accordance with the National Electrical Code (NEC) and any applicable local code requirements.
- ▶ All wiring connections should be capped with UL approved wire connectors.

CAUTION RISK OF INJURY

- ▶ Wear gloves and safety glasses at all times when removing luminaire from packaging, installing, servicing or performing maintenance.
- ▶ Avoid direct eye exposure to the light source while it is on.

CAUTION RISK OF PRODUCT DAMAGE

- ▶ Never connect components under load.
- ▶ Do not mount or support these fixtures in a manner that can cut the outer jacket or damaged wire insulation.
- ▶ Unless individual product specifications deem otherwise: Never connect an LED product directly to dimmer packs, occupancy sensors, timing devices, or other control devices. LED fixtures must be powered directly off a switched circuit.
- ▶ Unless individual product specifications deem otherwise: Do not restrict fixture ventilation. Allow for some volume of airspace around the fixture. Avoid covering LED fixtures with insulation, foam, or other material that will prevent convection or cooling.
- ▶ Unless individual product specifications deem otherwise: Do not exceed fixtures' maximum ambient temperature.
- ▶ Only use the fixture in its intended location.
- ▶ LED products are polarity sensitive. Ensure proper polarity before installation.
- ▶ Electrostatic Discharge (ESD): ESD can damage LED fixtures. Personal grounding equipment must be worn during all installation or servicing of the unit.

WARNING RISK OF BURN

- ▶ Allow lamp/fixture to cool before handling. Do not touch enclosure, lens or light source.
- ▶ Do not exceed maximum wattage marked on luminaire label.
- ▶ Follow all manufacturer's warnings, recommendations and restrictions including but not limited to: driver type, mounting locations/methods, replacement and recycling.
- ▶ Use only lamps that comply with ANSI standards.

CAUTION RISK OF FIRE

- ▶ Keep combustible and other materials that can burn, away from lamp/lens.
- ▶ Do not operate in close proximity to persons, combustible materials, or substances affected by heat.

- ▶ Do not touch individual electrical components as this can cause ESD, shorten lamp life, or alter performance.
- ▶ Some components inside the fixture may not be serviceable. If your unit requires service, stop using the unit immediately and contact a manufacture representative for assistance.
- ▶ Changes or modifications not expressly approved by manufacturer will void the product warranty.
- ▶ Always read the fixtures' complete installation instructions prior to installation for any additional fixture-specific warnings.

» Package

1. VTL LED Vapor Tight Light
2. Installation Instruction
3. Mounting Accessories

» Installation Instructions

ALWAYS TURN OFF THE POWER SUPPLY FROM MAIN CIRCUIT BREAKER FIRST!

Installation Method 1

Surface Mount

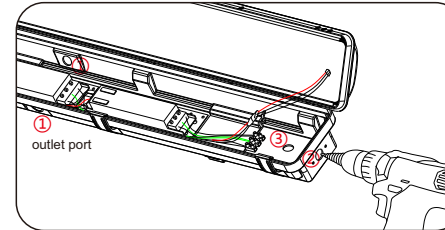

1. Before installation, please confirm the outlet port in advance and drill it to prepare for subsequent wiring.

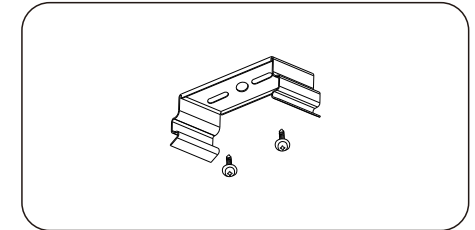

2. Secure mounting clips to ceiling using 4-8 screws. Space the clips 33.67 inches apart for 4ft luminaire, or 37.8 inches apart for 8ft luminaire.

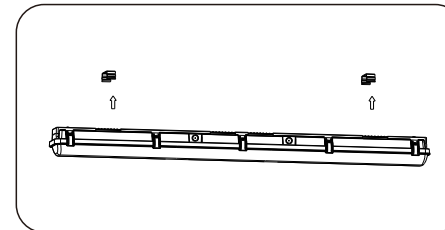

3. Orient the luminaire so conduit fitting faces incoming supply power or conduit. Apply gentle upward pressure to secure luminaire onto both mounting clips.

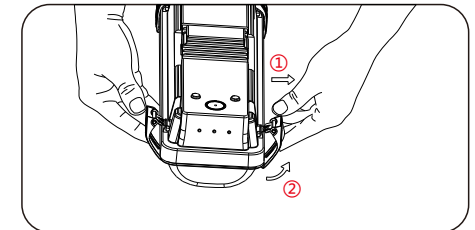

4. Release latches by pulling top of latch away from housing. Remove lens and set aside.

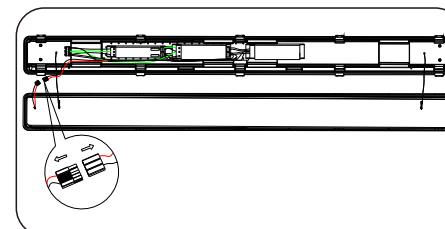

5. Disconnect the wire connecting the LED board and the driver to avoid unstable connection due to heavy suspension.

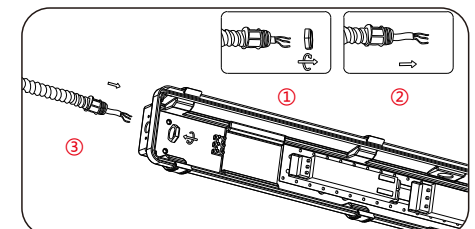

6. After passing the input wire through the hose, connect the hose to the light fixture as shown.

Please read this manual carefully before using the product

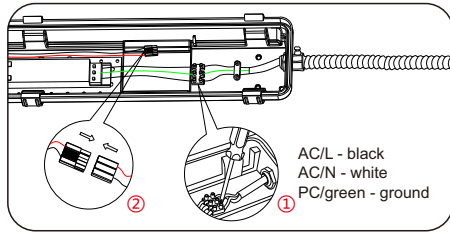

7. After the wire connection is completed, reconnect the wiring between the LED board and the driver.

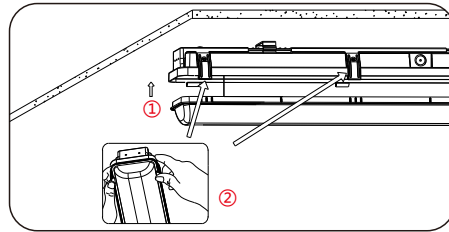

8. After aligning the lens and bottom housing, turn off the luminaire. Secure lens to housing with lens latches.

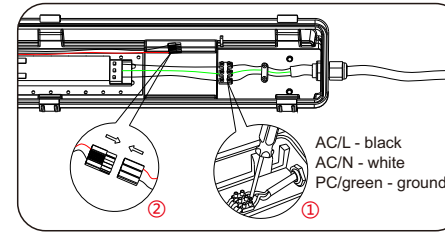

7. After the connection is completed, tighten the waterproof plug. Reconnect the wiring between the LED board and the driver.

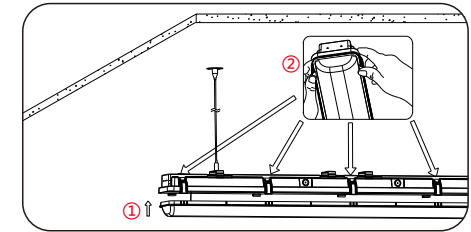

8. After align lens and bottom housing, turn off the luminaire. Secure lens to housing with lens latches.

Installation Method 2 Suspension Mount

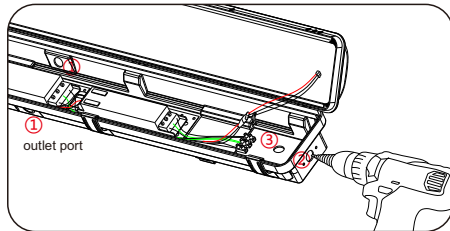

1. Before installation, please confirm the outlet port in advance and drill it to prepare for subsequent wiring.

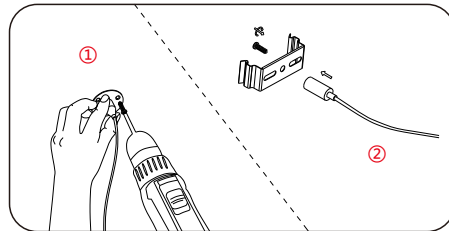

2. "Secure one side of the suspension mounting kit to the ceiling using 6-12 screws*. Secure the other side to the clips using 2-4 screws*

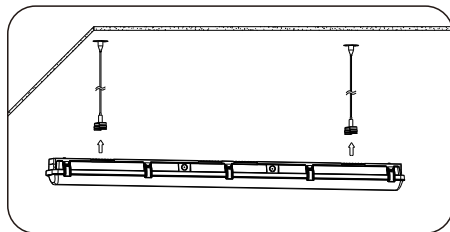

3. Orient the luminaire so conduit fitting faces incoming supply power or conduit. Apply gentle pressure to secure luminaire onto both mounting clips.

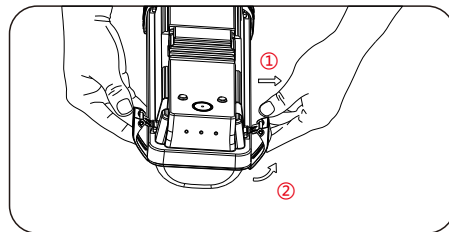

4. Release latches by pulling top of latch away from housing. Remove lens and set aside.

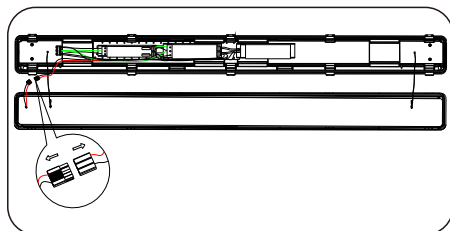

5. Disconnect the wire connecting the LED board and the driver to avoid unstable connection due to heavy suspension.

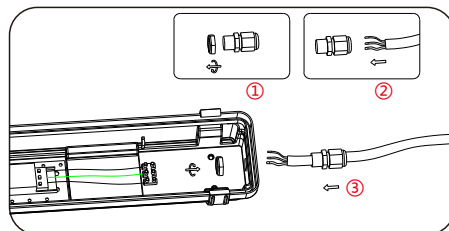

6. Separate the waterproof plug, and connect the input wire to output wire of the driver after passing through the plug and outlet as shown in the figure.

» TROUBLESHOOTING

1. Check that the line voltage at the fixture is correct. Refer to wiring directions.
2. Is the fixture grounded properly.
3. Be sure the photocell, if used, is functioning properly.

» Wattage & CCT Selectable

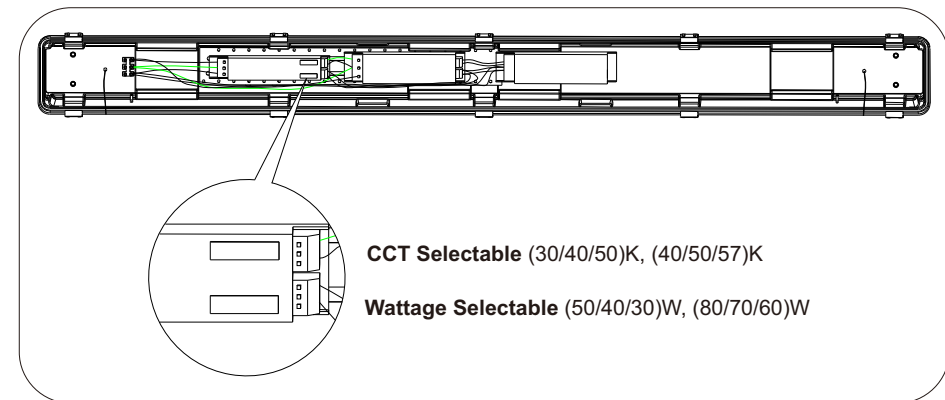

» Wiring Diagram

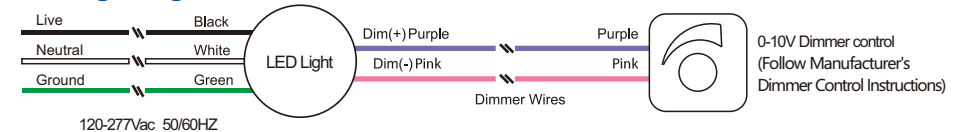

» Suspension Mounting

- *4ft Vapor Tight Lights include 6 screws for mounting to the ceiling & 2 screws for the clips.
- *8ft Vapor Tight Lights include 12 screws for mounting to the ceiling & 4 screws for the clips.