

Regular cleaning with mild soap on a soft cloth, followed by a clean damp cloth, then a dry cloth, will preserve the original luster and beauty of this fine finish of your Romina Furniture product.



Thank you for being one of our distinguished clients.

Romina[®]
Furniture *Team*

Visit
www.rominafurniture.com
for updates, special offers and more new designs.

THIS CRIB CONFORMS TO APPLICABLE REGULATIONS PROMULGATED BY THE CONSUMER PRODUCT SAFETY COMMISSION AND BY THE AMERICAN SOCIETY FOR TESTING AND MATERIALS

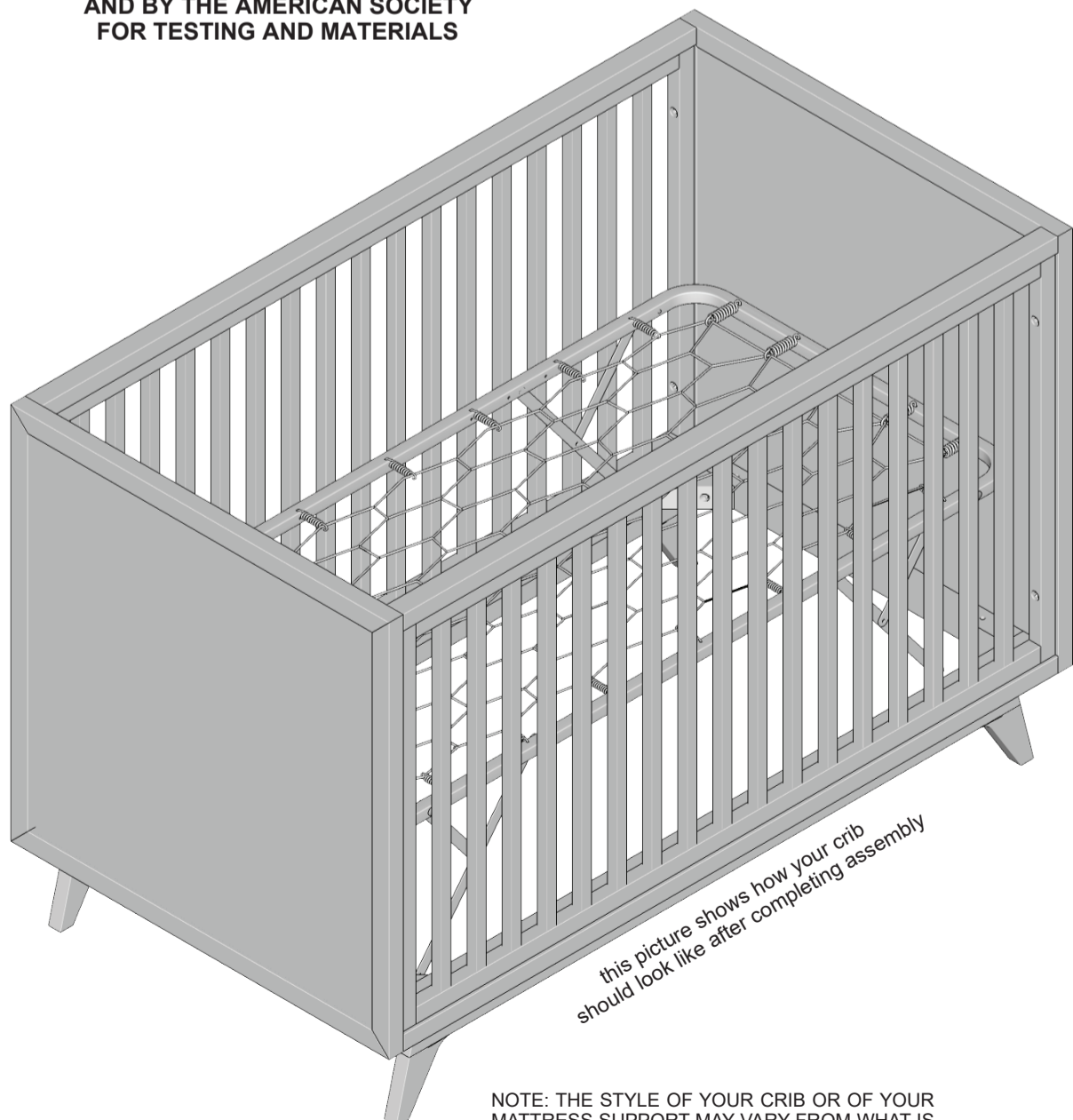

this picture shows how your crib should look like after completing assembly

NOTE: THE STYLE OF YOUR CRIB OR OF YOUR MATTRESS SUPPORT MAY VARY FROM WHAT IS PICTURED IN THE INSTRUCTION SHEET

ASSEMBLY INSTRUCTIONS FOR YOUR 15510 STATIONARY CRIB

WARNING: THE PROPER USE OF THIS CRIB IS IMPORTANT FOR YOUR BABY'S SAFETY. TO KEEP YOUR BABY SECURE AND SAFE, AND TO AVOID POTENTIAL INJURY OR DEATH, CAREFULLY READ AND FAMILIARIZE YOURSELF WITH ALL WARNINGS, CAUTIONS AND INSTRUCTIONS IN THIS BOOKLET. KEEP THIS INSTRUCTION BOOKLET FOR FUTURE USE.

DO NOT THROW THIS INSTRUCTION BOOKLET!

- * READ ALL INSTRUCTIONS BEFORE ASSEMBLING CRIB. KEEP INSTRUCTIONS FOR FUTURE USE.
- * NEVER USE PLASTIC SHIPPING BAGS OR OTHER PLASTIC FILM AS MATTRESS COVERS BECAUSE THEY CAN CAUSE SUFFOCATION.
- * INFANTS CAN SUFFOCATE IN GAPS BETWEEN CRIB SIDES AND A MATTRESS THAT IS TOO SMALL.

Romina[®]
Furniture

4300 Northlake Ct, Ste E, Charlotte, NC 28216
Phone: 980-585-1460 / contact@rominafurniture.com
www.rominafurniture.com

⚠️WARNING! INFANTS CAN SUFFOCATE ON SOFT COMFORTER. NEVER PLACE ADDITIONAL PADDING UNDER AN INFANT. FAILURE TO FOLLOW THESE WARNINGS AND ASSEMBLY INSTRUCTIONS COULD RESULT IN SERIOUS INJURY OR DEATH.

CAUTION: ANY MATTRESS USED IN THIS CRIB SHALL BE AT LEAST 27 1/4 BY 51 5/8 IN. WITH A THICKNESS NOT EXCEEDING 6 IN.

- TO REDUCE THE RISK OF SIDS, PEDIATRICIANS RECOMMEND HEALTHY INFANTS BE PLACED ON THEIR BACKS TO SLEEP, UNLESS OTHERWISE ADVISED BY YOUR PHYSICIAN.

STRANGULATION HAZARD:

- STRINGS CAN CAUSE STRANGULATION! **DO NOT** PLACE ITEMS WITH A STRING AROUND A CHILD'S NECK, SUCH AS HOOD STRINGS OR PACIFIER CORDS. **DO NOT** SUSPEND STRINGS OVER A CRIB OR ATTACH STRINGS TO TOYS.
- TO HELP PREVENT STRANGULATION TIGHTEN ALL FASTENERS. A CHILD CAN TRAP PARTS OF THE BODY OR CLOTHING ON LOOSE FASTENERS.
- **DO NOT** PLACE CRIB NEAR WINDOW WHERE CORDS FROM BLINDS OR DRAPES MAY STRANGLE A CHILD.

FALL HAZARD:

- WHEN CHILD IS ABLE TO PULL TO A STANDING POSITION, SET MATTRESS TO LOWEST POSITION AND REMOVE BUMPER PADS, LARGE TOYS AND OTHER OBJECTS THAT COULD SERVE AS STEPS FOR CLIMBING OUT.
- STOP USING CRIB WHEN CHILD BEGINS TO CLIMB OUT OR REACHES THE HEIGHT OF 35 IN. (89 CM).

- CHECK THIS PRODUCT FOR DAMAGED HARDWARE, LOOSE JOINTS, LOOSE BOLTS OR OTHER FASTENERS, MISSING PARTS, OR SHARP EDGES BEFORE AND AFTER ASSEMBLY AND FREQUENTLY DURING USE. SECURELY TIGHTEN LOOSE BOLTS AND OTHER FASTENERS. **DO NOT** USE CRIB IF ANY PARTS ARE MISSING, DAMAGED OR BROKEN. CONTACT **ROMINA FURNITURE** FOR REPLACEMENT PARTS AND INSTRUCTIONAL LITERATURE IF NEEDED. **DO NOT** SUBSTITUTE PARTS.

- IF REFINISHING, USE AN ANON-TOXIC FINISH SPECIFIED FOR CHILDREN'S PRODUCTS.

- FOLLOW WARNINGS ON ALL PRODUCTS IN A CRIB.

- READ ALL INSTRUCTIONS BEFORE ASSEMBLING CRIB. **KEEP INSTRUCTIONS FOR FUTURE USE.** A STORAGE POUCH & 2 PLASTIC TIES HAVE BEEN PROVIDED IN THE HARDWARE BAG. ATTACH POUCH TO MATTRESS SUPPORT WITH PLASTIC TIES AND STORE THE INSTRUCTIONS THERE.

- **NEVER** USE PLASTIC SHIPPING BAGS OR OTHER PLASTIC FILM AS MATTRESS COVERS BECAUSE THEY CAN CAUSE SUFFOCATION.

- INFANTS CAN SUFFOCATE IN GAPS BETWEEN CRIB SIDES AND A MATTRESS THAT IS TOO SMALL.

- **DO NOT** USE A WATER MATTRESS WITH THIS CRIB.

- BEFORE USING THIS CRIB RECHECK ALL SCREWS AND BOLTS TO BE SURE THEY ARE FASTENED SECURELY. A PERIODIC CHECK SHOULD BE MADE TO BE SURE THESE ITEMS REMAIN TIGHT.

- TO AVOID HEAD INJURY, **DO NOT** ALLOW ANY CHILD TO PLAY UNDERNEATH CRIB.

GENERAL FURNITURE CARE TIPS

- Wood, like any natural material is likely to present variations of grain and texture which will result in slight color variations or richness in the finish. These differences make each Romina Furniture item as beautiful and unique as you and your baby are.
- To preserve the initial appearance and functionality of your furniture, it is recommended that all furniture items be used in accordance with their intended design.
- Special water-based finishes are used to make this furniture safe for your baby. These finishes may be more delicate than those used on adult furniture thus requiring careful maintenance.
- Constant rubbing or mechanical interaction with sharp/hard objects such as belt buckles, jeans' zippers or buttons will likely damage the finish on your furniture. When placing or retrieving items onto the furniture, always set them down and pick them up, do not "slide" them. Items placed onto the horizontal surfaces must be moved/rotated to prevent discoloration in the finish.
- Exposure to extreme variations of environmental conditions such as humidity and temperature can affect the finish quality due to wood sudden expansion or shrinkage. It is recommended that the room temperature be maintained in between 65 and 75 degrees Fahrenheit and a relative humidity of 35 – 40%. Do not place items which are too hot or too cold directly onto the finished surfaces!
- Use caution when using a humidifier or vaporizer. Excessive moisture is harmful to the furniture causing the finish to peel and the wood to warp.
- Wipe up spills promptly. If water or other liquids stay in contact with the furniture for a long period of time, they can cause the finish to turn white or discolor. Alcohol or solvent containing substances or materials will permanently damage the finish.
- In general, furniture should not be placed in front or too close to air-conditioning outlets, fireplaces, heaters or humidifiers. Direct sunlight and ultraviolet rays will cause colors to fade, affect the luster and smoothness of the finish and in most cases may cause hairline cracks in the finish. White finishes will yellow naturally over time; exposure to direct sunlight will accelerate this natural process. Please note that all wood essences will darken over time along with the natural aging process which is not considered to be a quality defect.
- To clean the furniture, use a damp cloth immediately followed by wiping with a dry cloth. Do not allow water to stay in contact with the finish as it will damage the finish.
- If you need to put your furniture into storage for any period of time, avoid placing it in damp basements or hot attics. Air flow around and under the furniture should be allowed. Do not place furniture too close to walls, do not stack anything on it and do not cover it entirely.
- When using a vinyl changing pad or similar plastic accessories, make sure to use a fabric felt underneath. Certain plastics have ingredients that can react with and damage the finish. It is recommended to rotate the changing pad's position frequently to avoid finish discoloration.

NOTE: THE STYLE OF YOUR CRIB, METALLIC BRACKETS OR MATTRESS SUPPORT MAY VARY FROM WHAT IS PICTURED IN THE INSTRUCTION SHEET

15510 BOX CONTENT

Note: The letters which identifies a part are the initials of the respective part name (such method is employed to facilitate parts recognition between the drawings and the parts list).

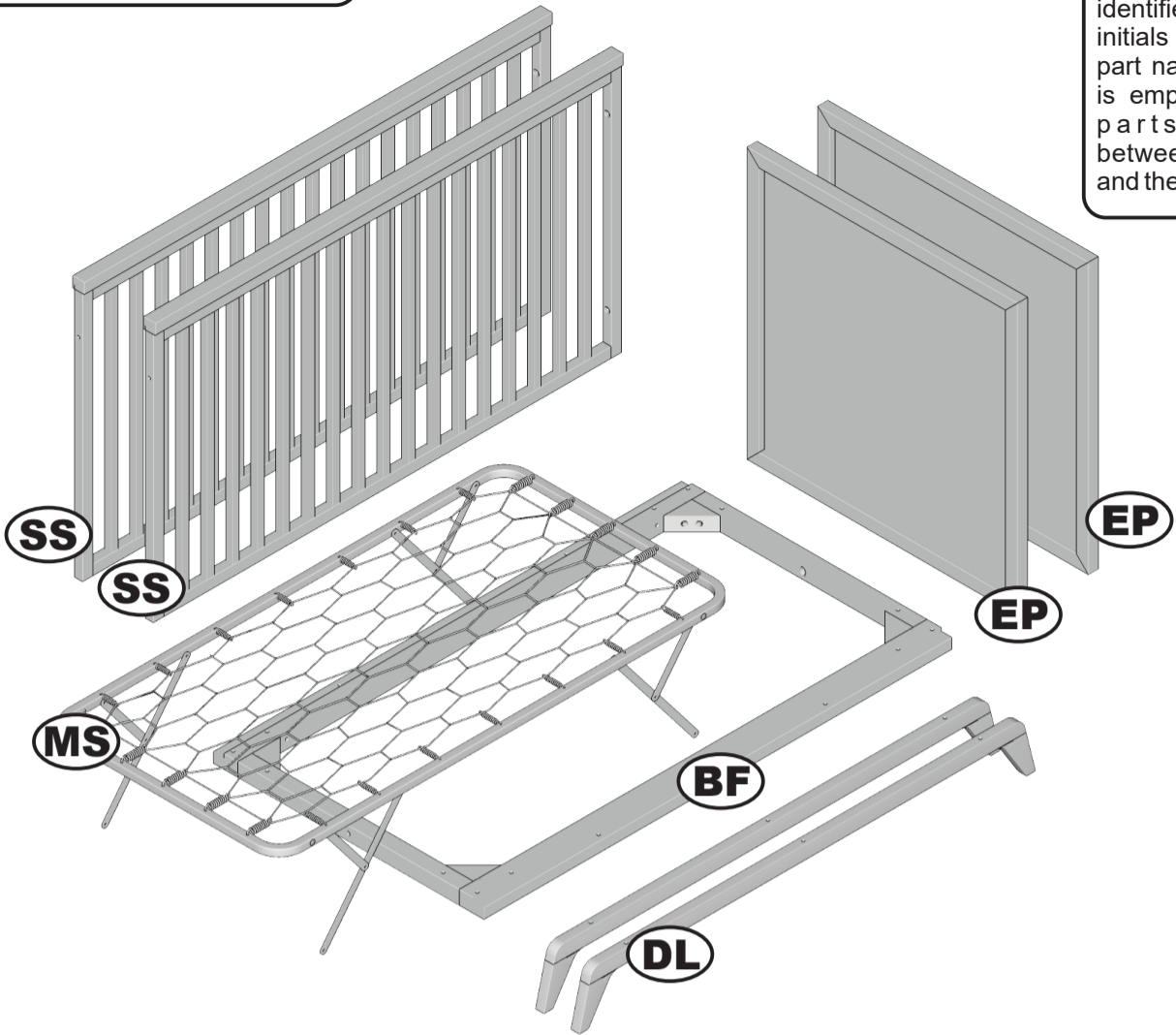

Please locate and confirm that you have the following parts:

- EP. end panel = 2
- SS. stationary side = 2
- BF. bottom frame = 1
- MS. mattress support = 1
- DL. decorative leg = 2

and one bag of hardware with the following:

1. bigger Allen wrench = 1
2. one storage pouch and two plastic ties
3. Allen bolt (40mm - 1 5/8" - w/o centering tip) = 12
4. Allen bolt (50mm - 2" - w/o centering tip) = 8
5. rounded head bolt (30mm - 1 1/8") = 4
6. rounded head bolt (15mm - 5/8") = 4
7. "butterfly" type nut = 4
8. "internal star" lock washer = 20
9. "external star" lock washer = 8



Required tools: Allen wrench (supplied), Phillips screwdriver (not included), flat screwdriver (not included).

CAUTION: Do not use a power screwdriver which can cause screws to break or strip.

Note: The item number of your product is located on the inner side of the left panel, on a black and white label. Please, refer to this number in the event that you need to call ROMINA FURNITURE or your local

Note: During the assembly process whenever using screws or bolts, check each by placing the screw / bolt on the hardware diagram which is drawn in actual size. Be sure to use the proper size and shape specified in the instructions. Be sure to **COMPLETELY TIGHTEN** the screws / bolts when you are

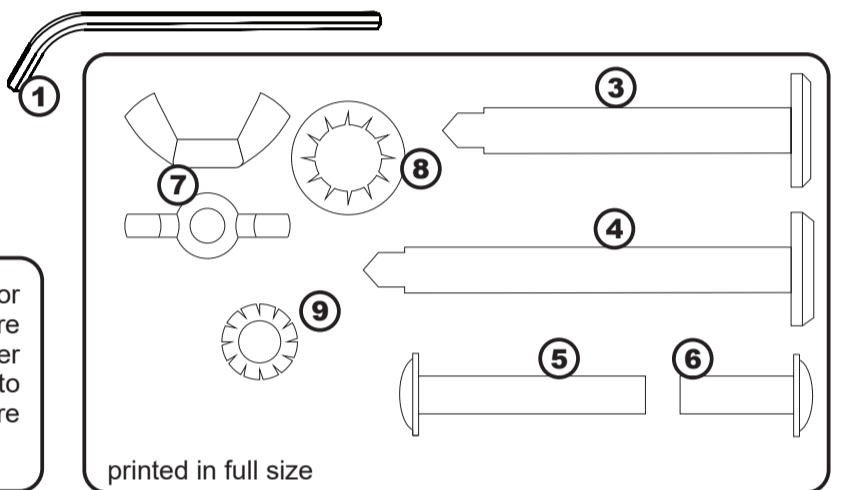

CAUTION:

- *WHEN A CHILD'S HEIGHT REACHES 35 INCHES, THE CHILD SHOULD BE PLACED IN A YOUTH OR REGULAR BED.
- *USE OF A VAPORIZER NEAR FURNITURE WILL CAUSE WOOD TO SWELL AND FINISH TO PEEL.
- *DO NOT STORE CRIB IN AREAS WHERE TEMPERATURES AND CONDITIONS ARE EXTREME. SUCH AS HOT ATTICS OR COLD DAMP BASEMENTS. BOTH OF THESE EXTREME CONDITIONS MAY CAUSE THE WOOD TO CRACK AND GLUE JOINTS TO LOOSEN RESULTING IN STRUCTURAL FAILURE.
- *SHOULD IT BECOME DESIRABLE TO REFINISH THIS CRIB IN LATER YEARS, THE MANUFACTURER WARNS THAT ANY MATERIAL USED SHOULD BE NON-TOXIC. REGULAR CLEANING WITH MILD SOAP ON A SOFT CLOTH, FOLLOWED BY A CLEAN DAMP CLOTH, THEN A DRY CLOTH, WILL PRESERVE THE ORIGINAL LUSTER AND BEAUTY OF THIS FINE FINISH.
- *THIS CRIB IS NOT EQUIPPED TO HANDLE THE EXCESS WEIGHT OF A CRIB WATER MATTRESS.
- *LIFT SLIGHTLY WHEN MOVING ON CARPETING TO PREVENT LEG BREAKAGE.

ENSURE A SAFE ENVIRONMENT FOR THE CHILD BY CHECKING REGULARLY, BEFORE PLACING THE CHILD IN THE CRIB, THAT EVERY COMPONENT IS PROPERLY AND SECURELY IN PLACE.

MAINTENANCE OF YOUR ROMINA CONVERTIBLE CRIB:

AFTER YOU FINISH ASSEMBLING YOUR CRIB, BE SURE THAT ALL BOLTS HAVE BEEN TIGHTENED SECURELY. YOU MUST CHECK ALL BOLTS PERIODICALLY AND RE-TIGHTEN AS NECESSARY. PERIODICALLY INSPECT CRIB FOR DAMAGED HARDWARE, LOOSE JOINTS OR SPLINTERED EDGES.

DO NOT USE CRIB IF PARTS ARE DAMAGED OR BROKEN! CONTACT YOUR DEALER OR **ROMINA FURNITURE** FOR ASSISTANCE AND REPLACEMENT PARTS. PLEASE BE SURE TO HAVE YOUR MODEL CODE WRITTEN DOWN BEFORE YOU MAKE CONTACT. THE MODEL CODE CAN BE FOUND ON A WHITE LABEL LOCATED ON THE INSIDE OF YOUR CRIB ON THE SIDE PANEL.

NEVER SUBSTITUTE PARTS OR MAKE ALTERATIONS TO YOUR CRIB!

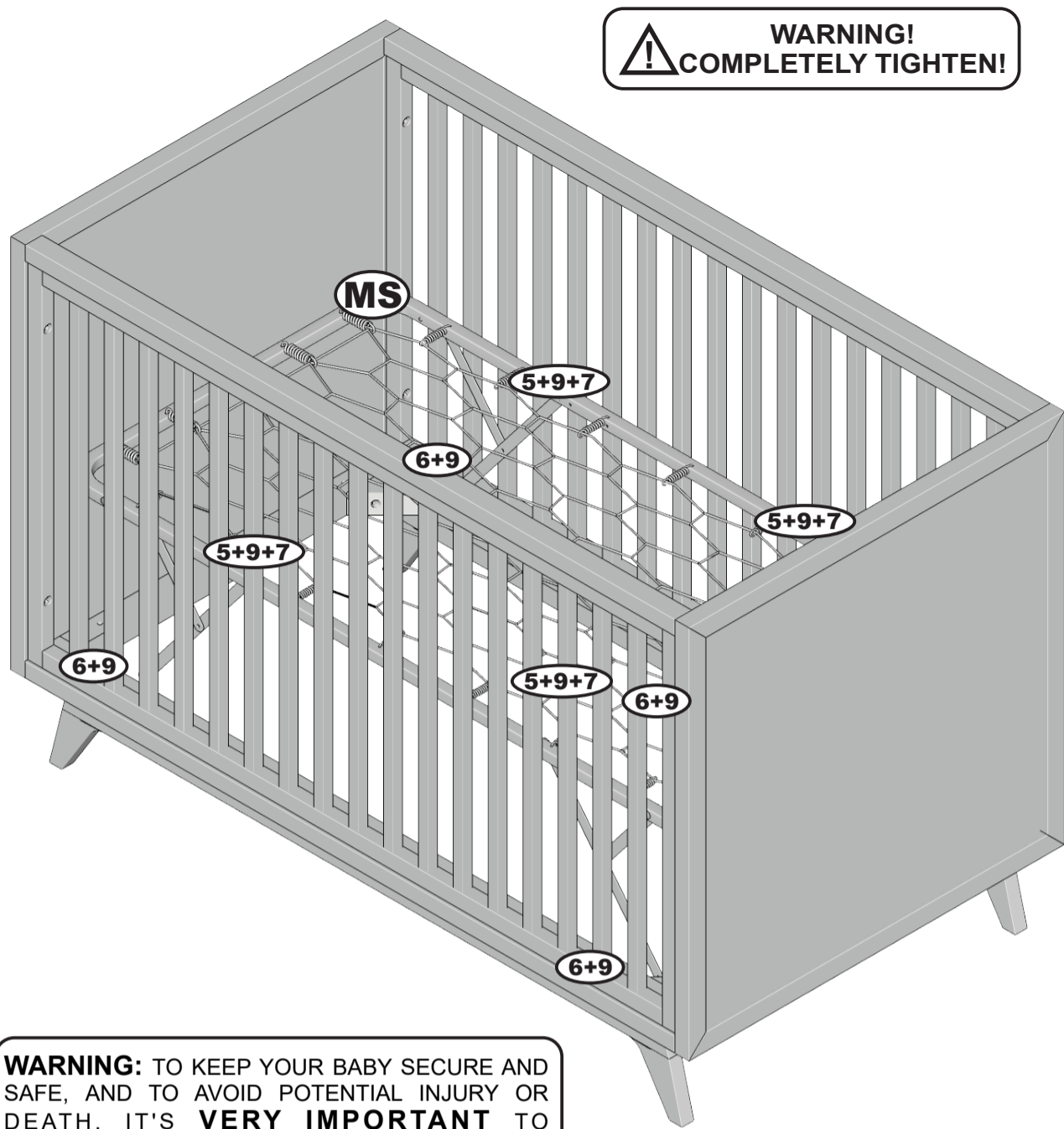

WARNING!
COMPLETELY TIGHTEN!

STEP 4 (Two adults are required to complete this step)

Attach the mattress support (MS) to the bottom frame (BF) using four smaller rounded head bolts (6), four smaller washers (9) and a Phillips screwdriver (not supplied). The lock washer must be attached to the bolt before inserting the bolt through the metallic bracket of the mattress support.

Completely tighten all 8 bolts (5+9+7, 6+9) involved in mattress support fixing using a Phillips screwdriver (not supplied).

REMINDER

You have to completely tighten 8 rounded head bolts, distributed as following:

- 4 bolts (5+9+7) in the mattress support;
- 4 bolts (6+9) in the bottom frame.

Attach the storage pouch supplied to the mattress support spring using two plastic ties (also supplied). Store this instruction booklet in the storage pouch for future use.

After completing assembly, your crib should look like the one depicted on the first page of this manual.

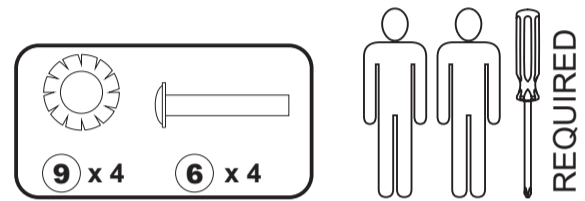

NOTE: THE STYLE OF YOUR CRIB, METALLIC BRACKETS OR MATTRESS SUPPORT MAY VARY FROM WHAT IS PICTURED IN THE INSTRUCTION SHEET

WARNING: TO KEEP YOUR BABY SECURE AND SAFE, AND TO AVOID POTENTIAL INJURY OR DEATH, IT'S **VERY IMPORTANT** TO **COMPLETELY TIGHTEN** ALL 8 BOLTS LISTED IN **STEP 4**.

FIGURE 4

STEP 1 (Two adults are required to complete this step)

Attach the stationary sides (SS) to the end panels (EP) using eight smaller Allen bolts (3), eight bigger washers (8) and the Allen key. Take care to insert the washer between the bolt and the stationary side vertical post!

Do not completely tighten the bolts at this step, you will be asked to do this later.

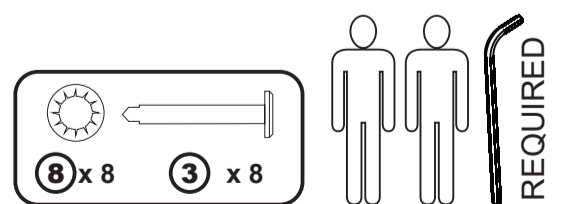
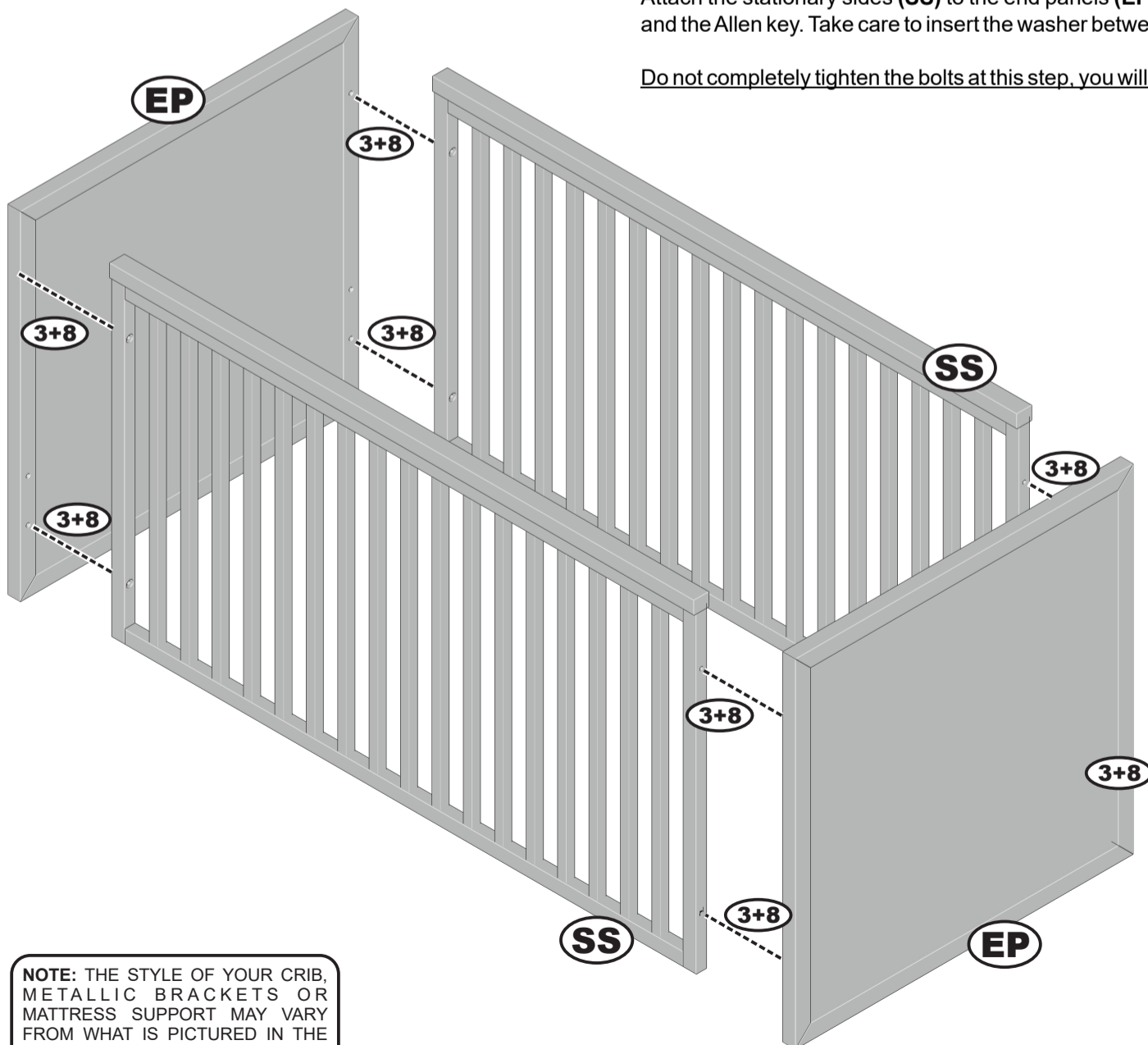

NOTE: THE STYLE OF YOUR CRIB, METALLIC BRACKETS OR MATTRESS SUPPORT MAY VARY FROM WHAT IS PICTURED IN THE INSTRUCTION SHEET

FIGURE 1

WARNING: TO KEEP YOUR BABY SECURE AND SAFE, AND TO AVOID POTENTIAL INJURY OR DEATH, IT'S **VERY IMPORTANT** TO **COMPLETELY TIGHTEN** ALL 12 BOLTS LISTED IN **STEP 2**.

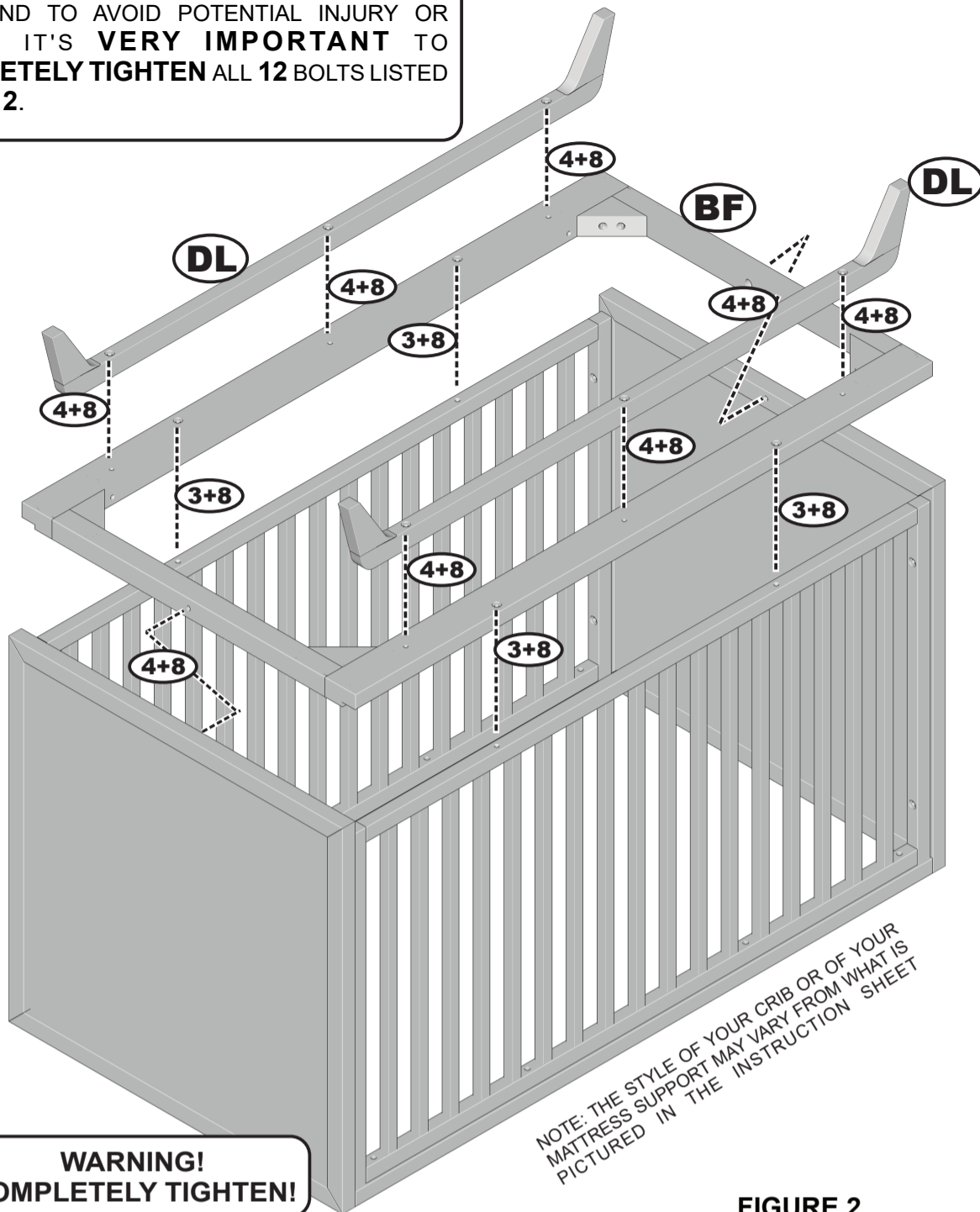

WARNING!
COMPLETELY TIGHTEN!

FIGURE 2

STEP 2 (Two adults are required to complete this step)

Turn the crib upside down, taking care not to scratch its finish.

Attach the base frame (BF) to the stationary sides (SS) and to the end panels (EP) using four smaller Allen bolts (3), four bigger washers (8) and the Allen key. Take care to insert the washer between the bolt and the base frame wooden components!

Attach the decorative legs (DL) to the crib using 8 bigger Allen bolts (4), 8 washers (8) and the smaller Allen key. Take care to insert the washer between the bolt and the leg!

Completely tighten all 4 smaller Allen bolts (3+8) and all 8 bigger Allen bolts (4+8).

Turn the crib in its normal position, taking care not to scratch its finish.

REMINDER

You have to completely tighten 8 bigger Allen bolts and 4 smaller Allen bolts, distributed as following:

- 4 smaller bolts (3+8) in the base frame;
- 8 bigger bolts (4+8) in the decorative legs.

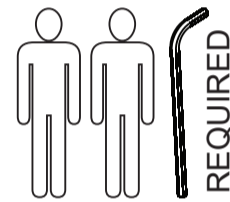
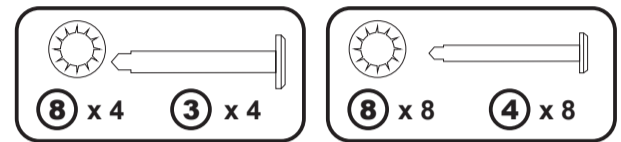

STEP 3 (One adult is required to complete this step)

Assemble the mattress support using 4 bigger round head bolts (5), 4 "butterfly" type nuts (7), 4 smaller lock washers (9) and a Phillips screwdriver (not supplied). The lock washer must be attached to the bolt after the bolt passed through the frame and the metallic bracket of the mattress support and before attaching the nut.

There are three positions for the mattress support (from the highest one for a newborn to the lowest one for a child that is maximum 35" tall - see caution note). You must adjust the height of the mattress support depending of your child height by inserting all four bolts in the same position (see **FIGURE 3**).

Do not completely tighten the bolts at this step, you will be asked to do this later.

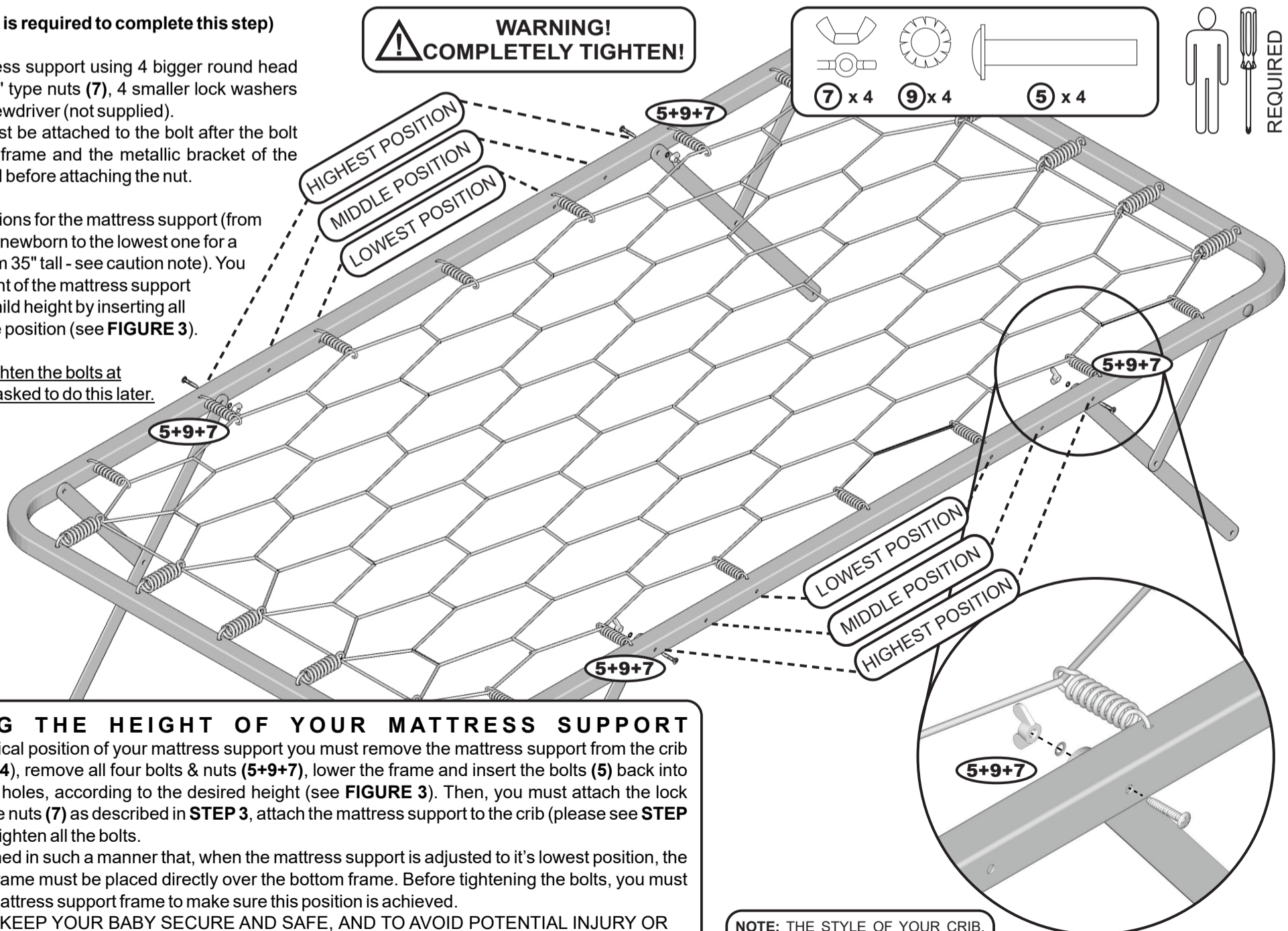

ADJUSTING THE HEIGHT OF YOUR MATTRESS SUPPORT

To adjust the vertical position of your mattress support you must remove the mattress support from the crib (please see **STEP 4**), remove all four bolts & nuts (5+9+7), lower the frame and insert the bolts (5) back into the corresponding holes, according to the desired height (see **FIGURE 3**). Then, you must attach the lock washers (9) and the nuts (7) as described in **STEP 3**, attach the mattress support to the crib (please see **STEP 4**) and completely tighten all the bolts.

Your crib is designed in such a manner that, when the mattress support is adjusted to it's lowest position, the mattress support frame must be placed directly over the bottom frame. Before tightening the bolts, you must slightly press the mattress support frame to make sure this position is achieved.

WARNING: TO KEEP YOUR BABY SECURE AND SAFE, AND TO AVOID POTENTIAL INJURY OR DEATH, IT'S **VERY IMPORTANT** TO **COMPLETELY TIGHTEN** ALL 8 BOLTS (5+9+7) & (6+9) AFTER YOU HAVE ADJUSTED THE HEIGHT OF YOUR MATTRESS SUPPORT.

NOTE: THE STYLE OF YOUR CRIB, METALLIC BRACKETS OR MATTRESS SUPPORT MAY VARY FROM WHAT IS PICTURED IN THE INSTRUCTION SHEET

FIGURE 3