

# ASSEMBLY INSTRUCTIONS FOR THE ANTONIO & CLEOPATRA 6501/7501 SP & TH CONVERTIBLE CRIBS

these pictures shows what you crib should look like after completing the assembly process

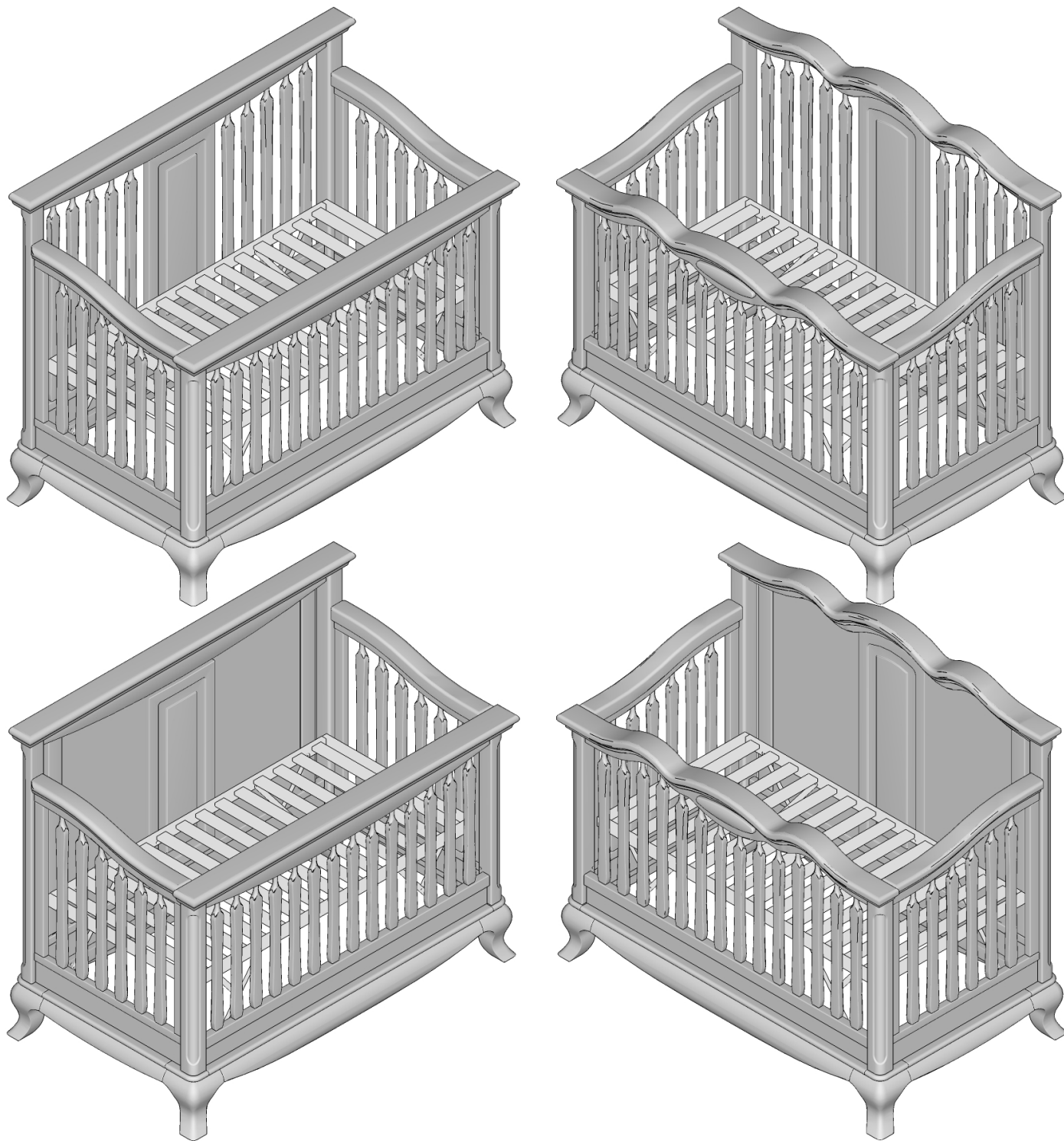

**READ ALL INSTRUCTIONS BEFORE ASSEMBLING THE CRIB. KEEP THE INSTRUCTION BOOKLET FOR FURTHER USE.**

**NEVER USE THE PLASTIC SHIPPING BAGS OR OTHER PLASTIC FILM AS MATTRESS COVERS, AS THEY CAN CAUSE SUFFOCATION.**

**MAKE SURE TO SELECT THE CORRECT SIZE MATTRESS. INFANTS CAN SUFFOCATE IN THE GAPS BETWEEN THE CRIB SIDES AND A MATTRESS THAT IS TOO SMALL.**

THIS CRIB CONFORMS TO APPLICABLE REGULATIONS PROMULGATED BY THE CONSUMER PRODUCT SAFETY COMMISSION AND BY THE AMERICAN SOCIETY FOR TESTING AND MATERIALS.

**WARNING:** THE PROPER USE OF THIS CRIB IS IMPORTANT FOR YOUR BABY'S SAFETY. IN ORDER TO KEEP YOU BABY SAFE AND SECURE, AS WELL AS AVOID POTENTIAL INJURY OR DEATH, PLEASE READ AND BECOME FAMILIAR WITH ALL THE WARNINGS, CAUTIONS AND INSTRUCTIONS IN THIS BOOKLET. KEEP THIS INSTRUCTION BOOKLET FOR FURTHER USE.

**DO NOT THROW THIS BOOKLET AWAY!**



4300 Northlake Ct, Ste E, Charlotte, NC 28216

Phone: 980-585-1460  
[www.rominafurniture.com](http://www.rominafurniture.com)

**⚠️ WARNING!** INFANTS CAN SUFFOCATE ON SOFT BEDDING. NEVER ADD A PILLOW OR COMFORTER. NEVER PLACE ADDITIONAL PADDING UNDER AN INFANT. FAILURE TO FOLLOW THESE WARNINGS AND ASSEMBLY INSTRUCTIONS COULD RESULT IN SERIOUS INJURIES OR DEATH.

**CAUTION: ANY MATTRESS USED IN THIS CRIB SHALL BE AT LEAST 27 <sup>1</sup>/<sub>4</sub> BY 51 <sup>5</sup>/<sub>8</sub> IN. WITH A THICKNESS NOT EXCEEDING 6 IN.**

- TO REDUCE THE RISK OF SIDS, PEDIATRICIANS RECOMMEND HEALTHY INFANTS BE PLACED ON THEIR BACKS TO SLEEP, UNLESS OTHERWISE ADVISED BY YOUR PHYSICIAN.

**STRANGULATION HAZARD:**

- STRINGS CAN CAUSE STRANGULATION! **DO NOT** PLACE ITEMS WITH A STRING AROUND A CHILD'S NECK, SUCH AS HOOD STRINGS OR PACIFIER CORDS. **DO NOT** SUSPEND STRINGS OVER A CRIB OR ATTACH STRINGS TO TOYS.

- TO HELP PREVENT STRANGULATION, TIGHTEN ALL FASTENERS. A CHILD CAN TRAP PARTS OF THE BODY OR CLOTHING ON LOOSE FASTENERS.

- **DO NOT** PLACE CRIB NEAR WINDOW WHERE CORDS FROM BLINDS OR DRAPES MAY STRANGLE A CHILD.

**FALL HAZARD:**

- WHEN CHILD IS ABLE TO PULL TO A STANDING POSITION, SET MATTRESS TO LOWEST POSITION AND REMOVE BUMPER PADS, LARGE TOYS AND OTHER OBJECTS THAT COULD SERVE AS STEPS FOR CLIMBING OUT.

- STOP USING CRIB WHEN CHILD BEGINS TO CLIMB OUT OR REACHES THE HEIGHT OF 35 IN. (89 CM).

- CHECK THIS PRODUCT FOR DAMAGED HARDWARE, LOOSE JOINTS, LOOSE BOLTS OR OTHER FASTENERS, MISSING PARTS, OR SHARP EDGES BEFORE AND AFTER ASSEMBLY AND FREQUENTLY DURING USE. SECURELY TIGHTEN LOOSE BOLTS AND OTHER FASTENERS. **DO NOT** USE CRIB IF ANY PARTS ARE MISSING, DAMAGED OR BROKEN. CONTACT **ROMINA FURNITURE** FOR REPLACEMENT PARTS AND INSTRUCTIONAL LITERATURE IF NEEDED. **DO NOT** SUBSTITUTE PARTS.

- IF REFINISHING, USE A NON-TOXIC FINISH SPECIFIED FOR CHILDREN'S PRODUCTS.

- FOLLOW WARNINGS ON ALL PRODUCTS IN A CRIB.

- READ ALL INSTRUCTIONS BEFORE ASSEMBLING CRIB. **KEEP INSTRUCTIONS FOR FUTURE USE.** A STORAGE POUCH & 2 PLASTIC TIES HAVE BEEN PROVIDED IN THE HARDWARE BAG. ATTACH POUCH TO MATTRESS SUPPORT WITH PLASTIC TIES AND STORE THE INSTRUCTIONS THERE.

- **NEVER** USE PLASTIC SHIPPING BAGS OR OTHER PLASTIC FILM AS MATTRESS COVERS BECAUSE THEY CAN CAUSE SUFFOCATION.

- INFANTS CAN SUFFOCATE IN GAPS BETWEEN CRIB SIDES AND A MATTRESS THAT IS TOO SMALL.

- **DO NOT** USE A WATER MATTRESS WITH THIS CRIB.

- BEFORE USING THIS CRIB, RE-CHECK ALL SCREWS AND BOLTS TO BE SURE THEY ARE FASTENED SECURELY. A PERIODIC CHECK SHOULD BE MADE TO BE SURE THESE ITEMS REMAIN TIGHT.

- TO AVOID HEAD INJURY, **DO NOT** ALLOW ANY CHILD TO PLAY UNDERNEATH CRIB.

## **GENERAL FURNITURE CARE TIPS**

- Wood, like any natural material is likely to present variations of grain and texture which will result in slight color variations or richness in the finish. These differences make each Romina Furniture item as beautiful and unique as you and your baby are.
- To preserve the initial appearance and functionality of your furniture, it is recommended that all furniture items be used in accordance with their intended design.
- Special water-based finishes are used to make this furniture safe for your baby. These finishes may be more delicate than those used on adult furniture thus requiring careful maintenance.
- Constant rubbing or mechanical interaction with sharp/hard objects such as belt buckles, jeans' zippers or buttons will likely damage the finish on your furniture. When placing or retrieving items onto the furniture, always set them down and pick them up, do not "slide" them. Items placed onto the horizontal surfaces must be moved/rotated to prevent discoloration in the finish.
- Exposure to extreme variations of environmental conditions such as humidity and temperature can affect the finish quality due to wood sudden expansion or shrinkage. It is recommended that the room temperature be maintained in between 65 and 75 degrees Fahrenheit and a relative humidity of 35 – 40 %. Do not place items which are too hot or too cold directly onto the finished surfaces!
- Use caution when using a humidifier or vaporizer. Excessive moisture is harmful to the furniture causing the finish to peel and the wood to warp.
- Wipe up spills promptly. If water or other liquids stay in contact with the furniture for a long period of time, they can cause the finish to turn white or discolor. Alcohol or solvent containing substances or materials will permanently damage the finish.
- In general, furniture should not be placed in front or too close to air-conditioning outlets, fireplaces, heaters or humidifiers. Direct sunlight and ultraviolet rays will cause colors to fade, affect the luster and smoothness of the finish and in most cases may cause hairline cracks in the finish. White finishes will yellow naturally over time; exposure to direct sunlight will accelerate this natural process. Please note that all wood essences will darken over time along with the natural aging process which is not considered to be a quality defect.
- To clean the furniture, use a damp cloth immediately followed by wiping with a dry cloth. Do not allow water to stay in contact with the finish as it will damage the finish.
- If you need to put your furniture into storage for any period of time, avoid placing it in damp basements or hot attics. Air flow around and under the furniture should be allowed. Do not place furniture too close to walls, do not stack anything on it and do not cover it entirely.
- When using a vinyl changing pad or similar plastic accessories, make sure to use a fabric felt underneath. Certain plastics have ingredients that can react with and damage the finish. It is recommended to rotate the changing pad's position frequently to avoid finish discoloration.



# BOX CONTENT

## 6501 TH & SP

**NOTE:** THE STYLE OF YOUR CRIB, METALLIC BRACKETS OR MATTRESS SUPPORT MAY VARY FROM WHAT IS PICTURED IN THE INSTRUCTION SHEET.

Please locate and confirm that you have the following parts:

**HB.** footboard = 1  
**FB.** headboard = 1  
**LP.** left panel = 1  
**RP.** right panel = 1

**MS.** mattress support = 1  
**SB.** stabilizing bars = 2  
**WR.** wooden rail = 1  
**WB.** wooden block = 2

**NOTE:** The letters by which a part can be identified represent the initials of the specific part's name (this method is used in order to facilitate parts recognition between the drawings and the parts list).

A bag of hardware containing the following accessories:

1. Allen wrench = 1  
 2. A storage pouch = 1  
 3. Plastic tie = 2  
 4. Allen bolt (60mm - 2 3/8") = 4  
 5. Rounded head bolt (15 mm - 19/32") = 4  
 6. Allen bolt (40mm - 1 9/16") = 4

7. Screw-in dowel = 2  
 8. Cam fitting = 2  
 9. Large "internal star" lock washer = 12  
 10. Allen bolt (70 mm - 2 3/4") = 4  
 11. Wood screw (flat head 20 mm - 3/4") = 3  
 12. Small "external star" lock washer = 4

**NOTE:** Phillips screwdriver not included!

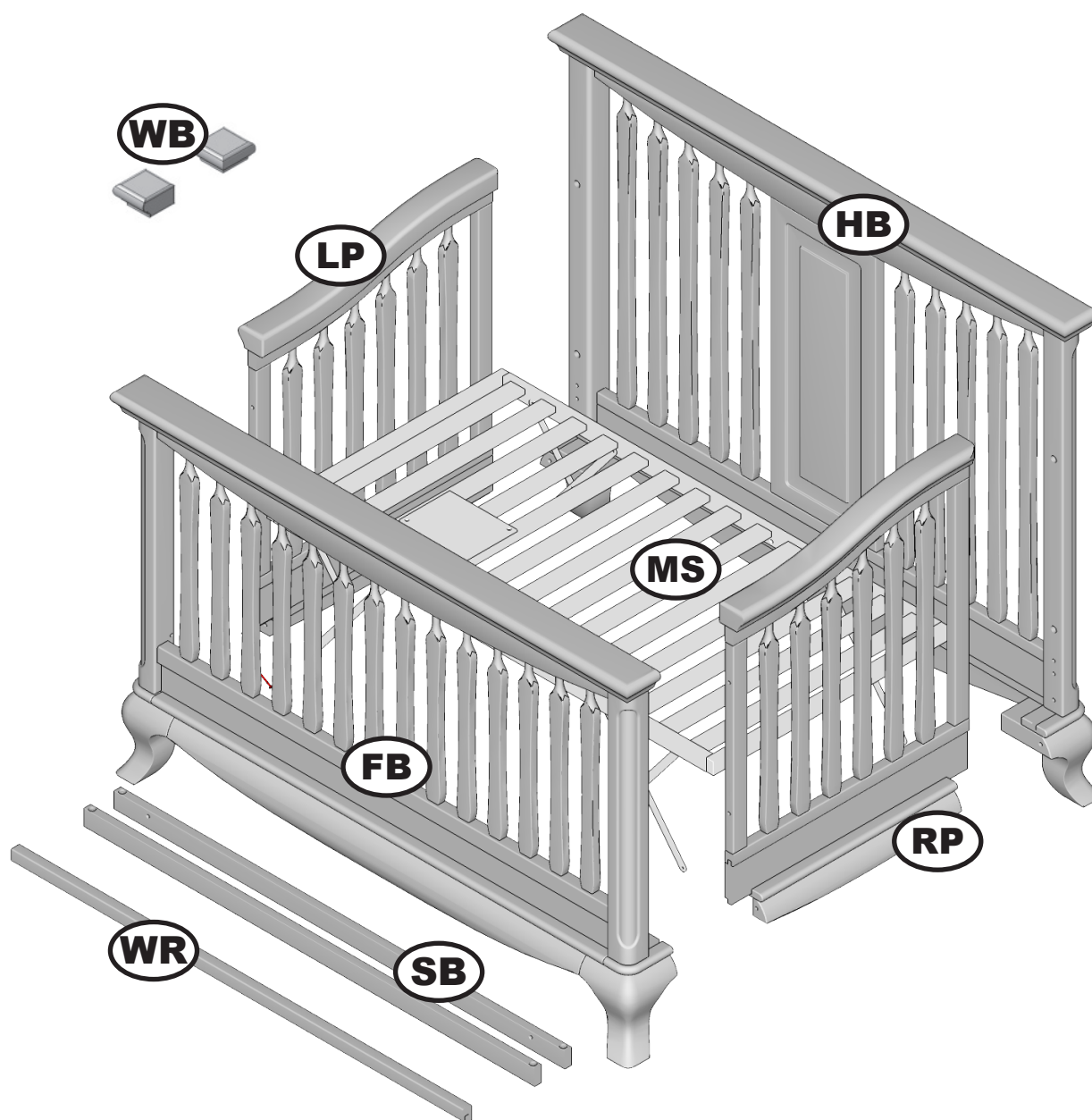
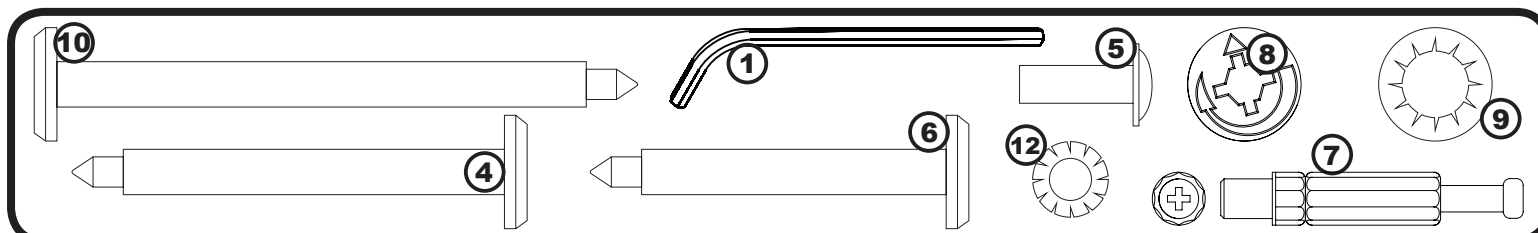

**NOTE:** The item number of your product is located on the inner side of the left panel, on a black and white label. Please refer to this number in the event of needing to contact ROMINA FURNITURE or your local supplier.

**NOTE:** During the assembly process, whenever using screws or bolts, check by using a measuring instrument for each of them, in order to identify the correct one. Be sure to use the proper size and shape specified in the instructions. Be sure to **COMPLETELY TIGHTEN** the screws and bolts when told to do so.

# BOX CONTENT

## 7501 TH & SP

**NOTE:** THE STYLE OF YOUR CRIB, METALLIC BRACKETS OR MATTRESS SUPPORT MAY VARY FROM WHAT IS PICTURED IN THE INSTRUCTION SHEET.

Please locate and confirm that you have the following parts:

HB. footboard = 1  
 FB. headboard = 1  
 LP. left panel = 1  
 RP. right panel = 1

MS. mattress support = 1  
 SB. stabilizing bars = 2  
 WR. wooden rail = 1  
 WB. wooden block = 2

**NOTE:** The letters by which a part can be identified represent the initials of the specific part's name (this method is used in order to facilitate parts recognition between the drawings and the parts list).

A bag of hardware containing the following accessories:

- |   |   |
|---|---|
| 1. Allen wrench = 1                       | 7. Screw-in dowel = 2                       |
| 2. A storage pouch = 1                    | 8. Cam fitting = 2                          |
| 3. Plastic tie = 2                        | 9. Large "internal star" lock washer = 12   |
| 4. Allen bolt (60mm - 2 3/8") = 4         | 10. Allen bolt (70 mm - 2 3/4") = 4         |
| 5. Rounded head bolt (15 mm - 19/32") = 4 | 11. Wood screw (flat head 20 mm - 3/4") = 3 |
| 6. Allen bolt (40mm - 1 9/16") = 4        | 12. Small "external star" lock washer = 4   |

**NOTE:** Phillips screwdriver not included!

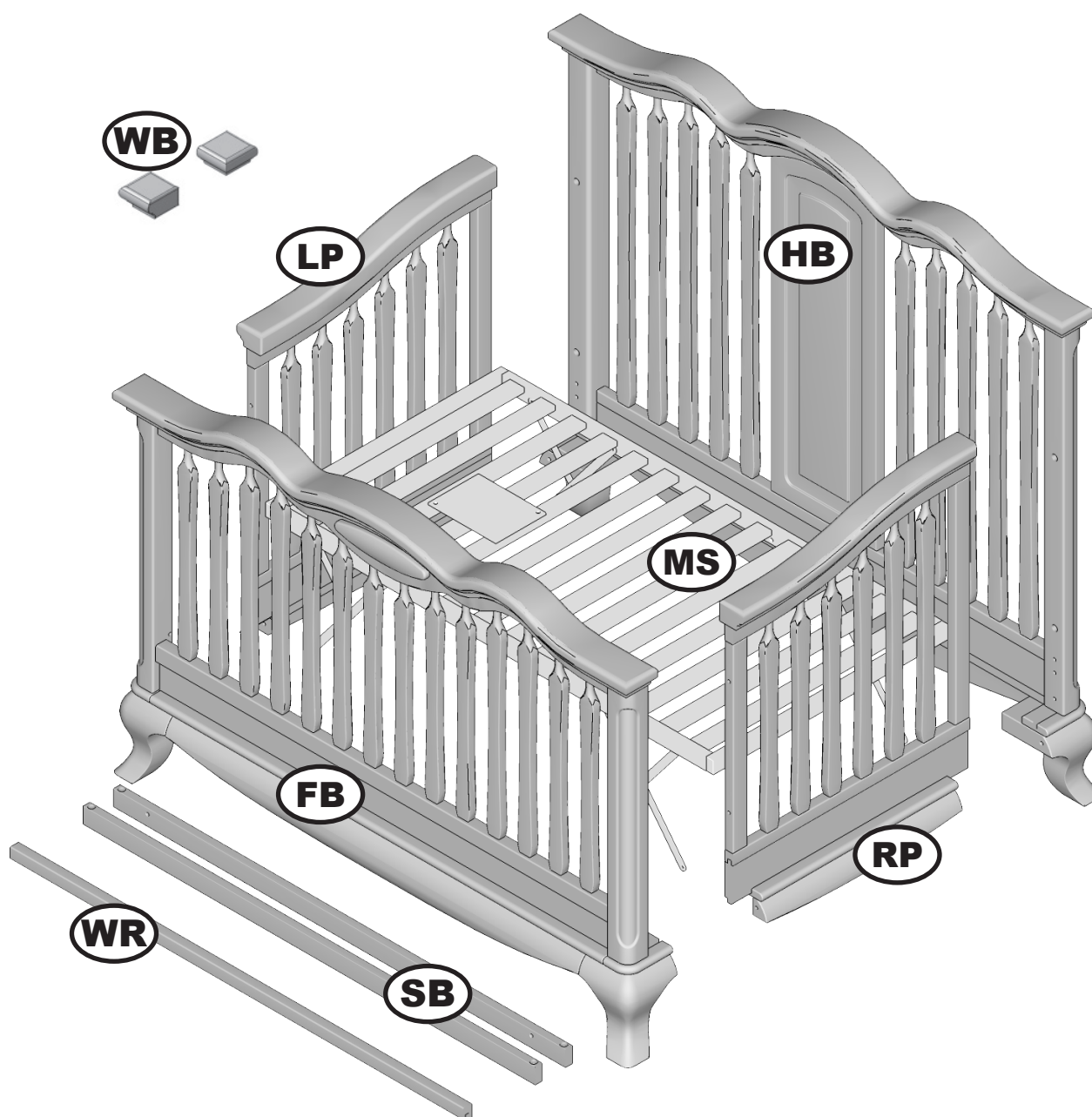
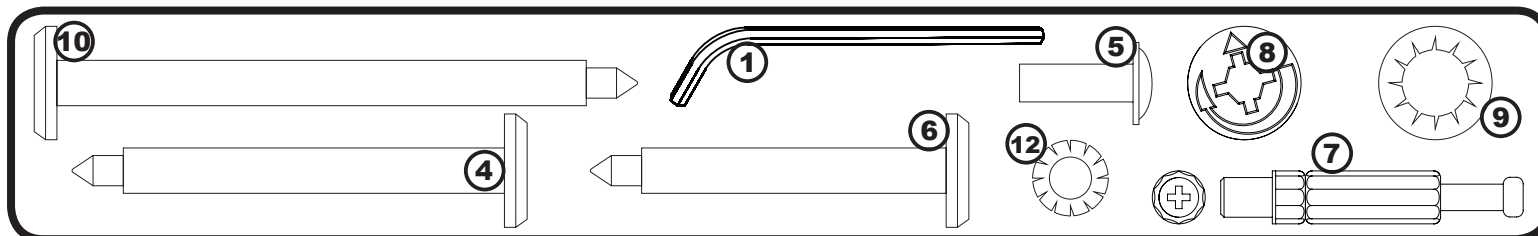

**NOTE:** The item number of your product is located on the inner side of the left panel, on a black and white label. Please refer to this number in the event of needing to contact ROMINA FURNITURE or your local supplier.

**NOTE:** During the assembly process, whenever using screws or bolts, check by using a measuring instrument for each of them, in order to identify the correct one. Be sure to use the proper size and shape specified in the instructions. Be sure to **COMPLETELY TIGHTEN** the screws and bolts when told to do so.

**STEP 1 (Two adults are required in order to complete this step)**  
**BOTH 6501 & 7501**

Take the footboard of your crib (**FB**) and carefully place it on the floor, with the drilled side facing upwards, taking care not to scratch its finish. Insert 2 small Allen bolts (**6**) and 2 large washers (**9**) into a stabilizing bar (**SB**) and attach it to the footboard using the Allen wrench supplied (**1**). Make sure that the metallic inserts face of the stabilizing bar is oriented towards the inside of the crib (follow the instructions attached to the stabilizing bar).

Completely tighten these two bolts.

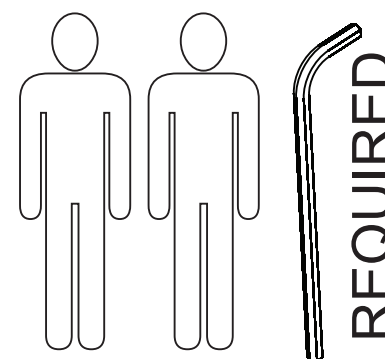

Attach the left and right panels (**LP**) & (**RP**) to the headboard using 2 small Allen bolts (**6**), 2 large washers (**9**) and the supplied Allen wrench (**1**). Do not completely tighten the bolts at this step, you will be asked to do this later. Attach the other stabilizing bar (**SB**) to the headboard using 2 small Allen bolts (**6**), 2 large washers (**9**) and the supplied Allen wrench (**1**). Make sure that the metallic inserts face of the stabilizing bar is facing towards the inside of the crib (follow the instructions attached to the stabilizing bar).

Completely tighten these two bolts.

Take the headboard (**HB**) and carefully place it over the part of your crib which has resulted after completing the steps above. Using 4 large Allen bolts (**10**), 4 large washers (**9**) and the Allen wrench supplied (**1**), attach the headboard to the right and left panels (**RP**) & (**LP**).

Always start the threads by hand in order to avoid stripping them.

Do NOT completely tighten the bolts at this point, you will be asked to do so later.

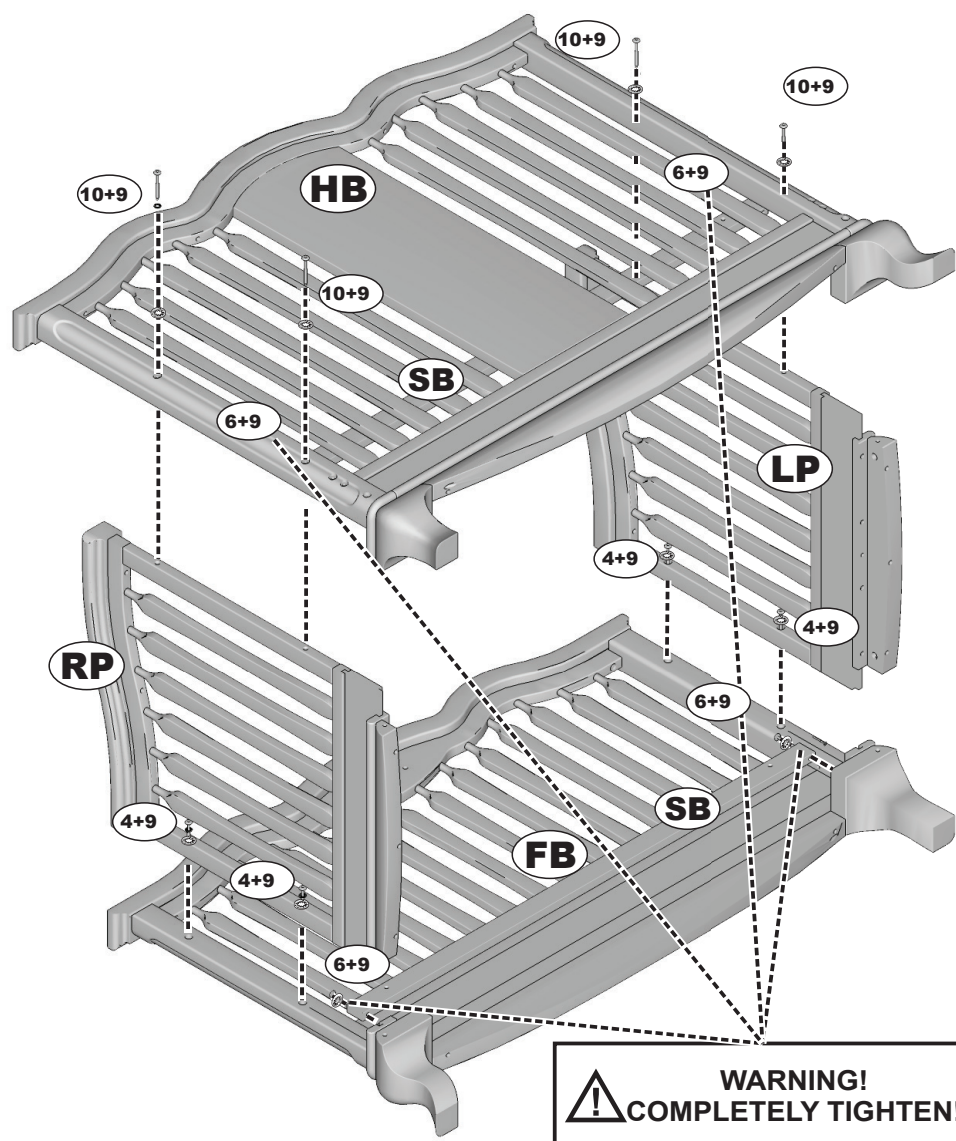

**WARNING:** IN ORDER TO KEEP YOUR BABY SECURE AND SAFE AND TO AVOID POTENTIAL INJURY OR DEATH, IT IS **VERY IMPORTANT TO COMPLETELY TIGHTEN ALL 12 BOLTS LISTED IN STEP 1.**

**FIGURE 1**

**NOTE:** THE STYLE OF YOUR CRIB, METALLIC BRACKETS OR MATTRESS SUPPORT MAY VARY FROM WHAT IS PICTURED IN THE INSTRUCTION SHEET.



# FIGURE 2

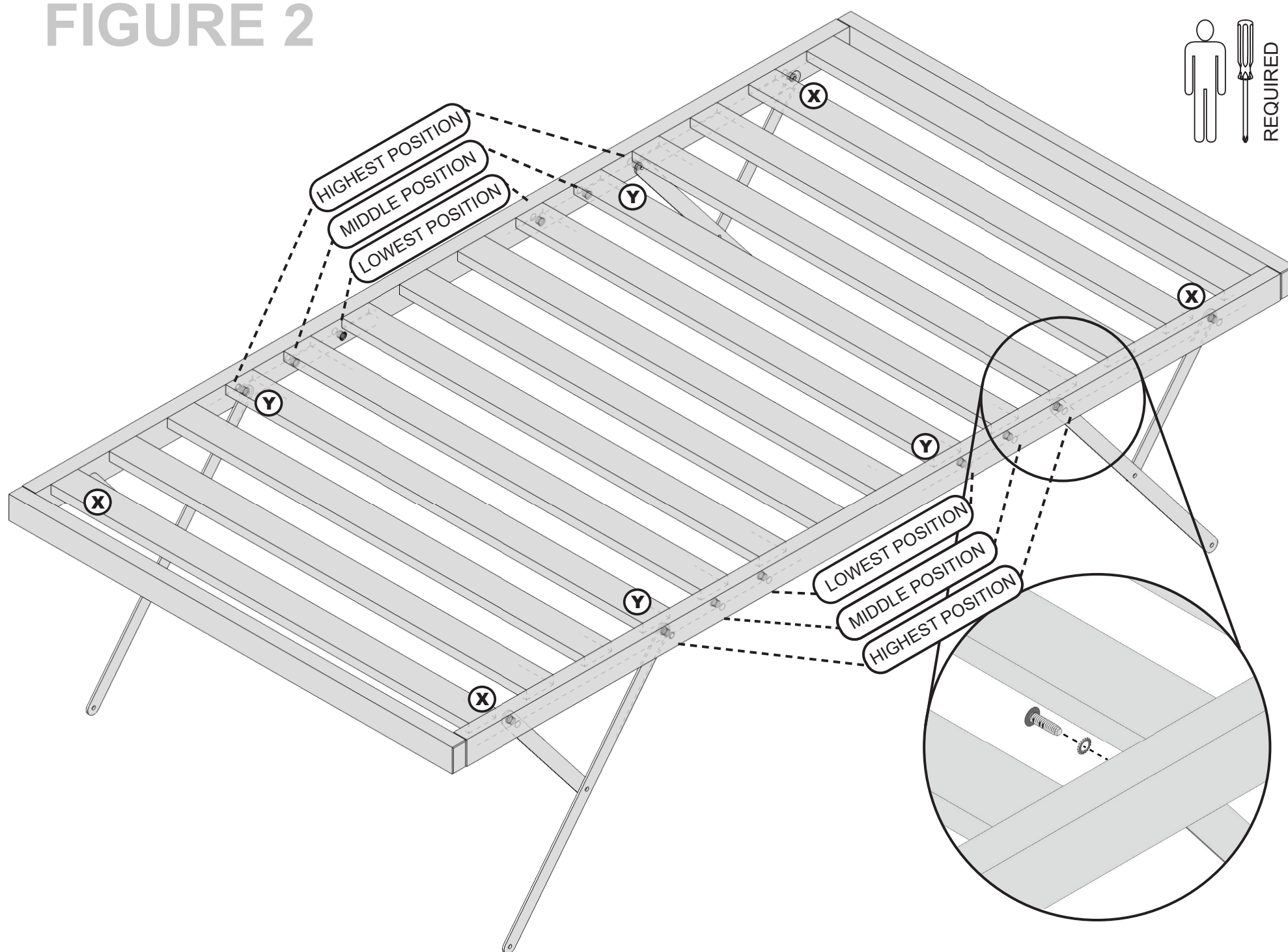
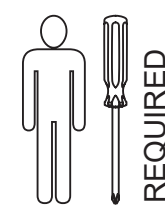

## **WARNING! COMPLETELY TIGHTEN!**

### **STEP 2 (One adult is required in order to complete this step)**

There are three different positions for the mattress support (the highest one being intended for a newborn child and the lowest one for a child that is maximum 35" tall - see cautions note). You must adjust the height of the mattress support (depending on your child's height), by inserting all 4 bolts and nuts (Y) in the same position (see **FIGURE 2**).

Bolts (X) and (Y) are factory mounted.

Do not completely tighten the bolts at this step; you will be asked to do so in a later step.

The mattress support will be assembled in the LOWEST POSITION.

## **ADJUSTING THE HEIGHT OF THE MATTRESS SUPPORT**

To adjust the vertical position of the mattress support, you must remove all four bolts and washers (Y), loosen all eight bolts (5+12, X), lower the frame and insert the bolts and washers (Y) back into the corresponding holes, according to the desired height (see **FIGURE 2**). Afterwards, completely tighten all bolts.

**The crib is designed in such a manner that, when the mattress support is adjusted to its lowest position, the mattress support frame must be placed directly over the bottom frame. Before tightening the bolts, we recommend slightly pressing down on the mattress support, in order to ensure its correct positioning.**

**WARNING: IN ORDER TO KEEP YOUR BABY SECURE AND SAFE AND TO AVOID POTENTIAL INJURY OR DEATH, IT IS VERY IMPORTANT TO COMPLETELY TIGHTEN ALL 12 BOLTS (X), (Y) & (5+12) AFTER ADJUSTING THE HEIGHT OF THE MATTRESS SUPPORT.**

**STEP 3 (Two adults are required in order to complete this step)**  
**BOTH 6501 & 7501**

Mount the mattress support (MS) to the stabilizing bars, as they resulted after the completion of **STEP 1**, using 4 rounded head bolts (5), 4 small washers (12) and a Phillips screwdriver (which is not supplied). The lock washer must be attached to the bolt before inserting the bolt through the metallic bracket of the mattress support. Afterwards, **completely tighten** all 12 bolts (X, Y, 5+12) involved in the mattress support fixing process by using a Phillips screwdriver (which is not supplied) and all 8 Allen bolts (10+9, 4+9) ch remained untightened from all previous steps (see **FIGURE 3**).

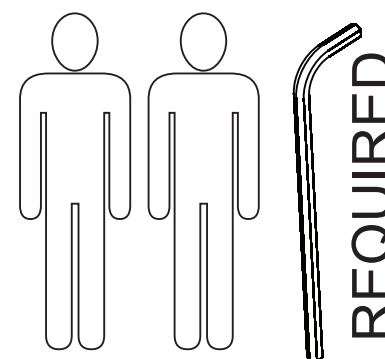

**REMINDER**

There are a total of **16** bolts, distributed as following:

- 4 large Allen bolts (10+9) in the headboard (HB);
- 4 Allen bolts (4+9) in the footboard (FB);
- 8 rounded head bolts (X, Y - factory mounted) in the mattress support (MS);
- 4 rounded head bolts (5+12) in the stabilizing bars (SB).

**STEP 4 (Two adults are required in order to complete this step)**  
**BOTH 6501 & 7501**

Return the crib to its regular position, with its feet on the floor. Attach the storage pouch supplied to the mattress support using the two plastic ties (also supplied). Store this instruction booklet in the storage pouch for further use. After completing the assembly, your crib should look like the one depicted on the first page of this instructions manual.

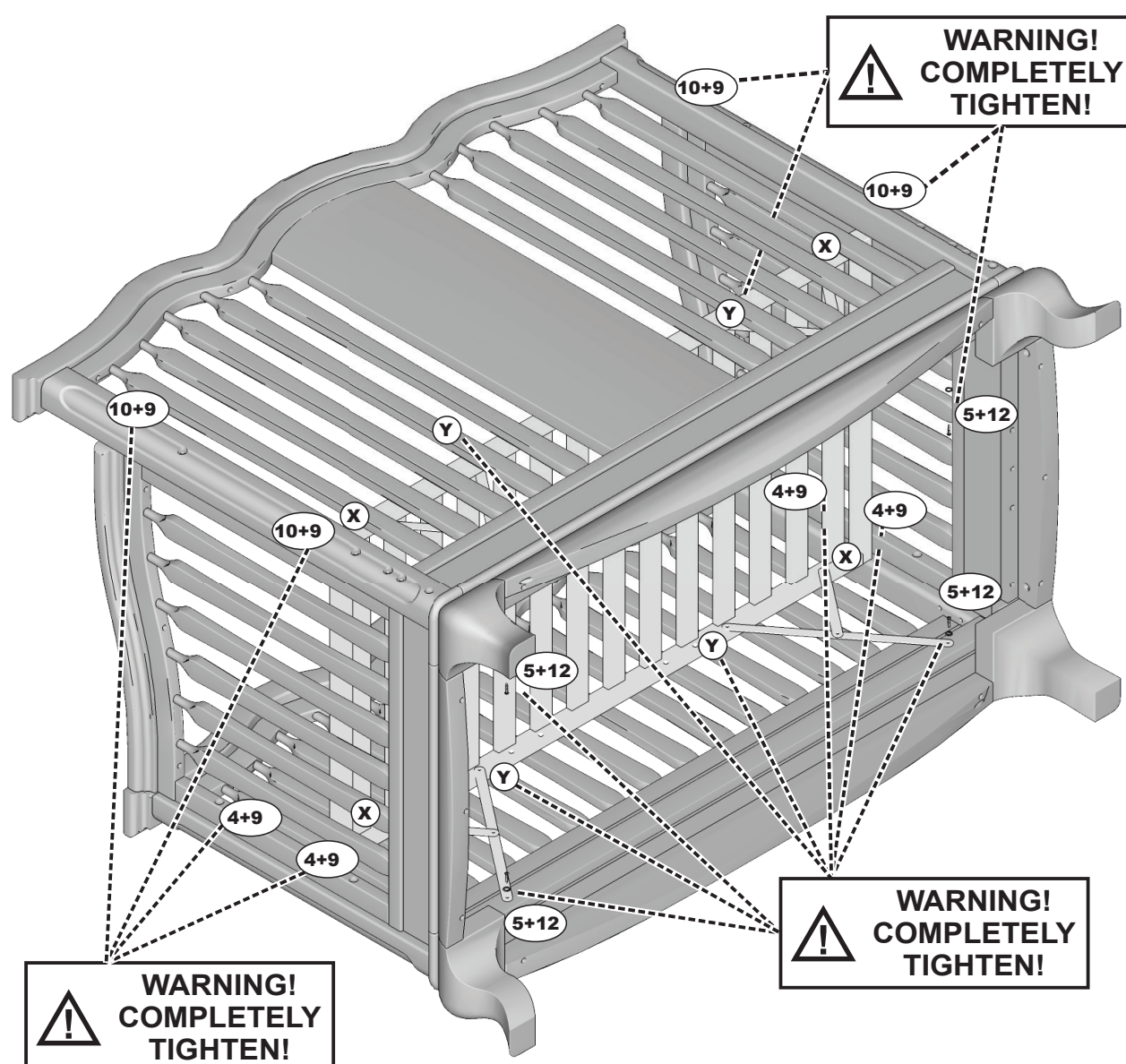

**FIGURE 3**

**WARNING:** IN ORDER TO KEEP YOUR BABY SECURE AND SAFE AND TO AVOID POTENTIAL INJURY OR DEATH, IT IS **VERY IMPORTANT TO COMPLETELY TIGHTEN ALL 16 BOLTS LISTED IN STEP 3.**

**NOTE:** THE STYLE OF YOUR CRIB, METALLIC BRACKETS OR MATTRESS SUPPORT MAY VARY FROM WHAT IS PICTURED IN THE INSTRUCTION SHEET.



# ASSEMBLY INSTRUCTIONS FOR THE ANTONIO & CLEOPATRA 6501/7501 SP & TH DAY BED OPTION

THIS CRIB CONFORMS TO APPLICABLE REGULATIONS PROMULGATED BY THE CONSUMER PRODUCT SAFETY COMMISSION AND BY THE AMERICAN SOCIETY FOR TESTING AND MATERIALS.

this picture shows what your crib should look like after completing the assembly process



**READ ALL INSTRUCTIONS BEFORE ASSEMBLING THE CRIB. KEEP THE INSTRUCTION BOOKLET FOR FURTHER USE.**

**NEVER USE THE PLASTIC SHIPPING BAGS OR OTHER PLASTIC FILM AS MATTRESS COVERS, AS THEY CAN CAUSE SUFFOCATION.**

**MAKE SURE TO SELECT THE CORRECT SIZE MATTRESS. INFANTS CAN SUFFOCATE IN THE GAPS BETWEEN THE CRIB SIDES AND A MATTRESS THAT IS TOO SMALL.**

**WARNING (FOR DAY BED OPTION ONLY):**

-ANY MATTRESS USED IN THIS CRIB MUST BE AT LEAST 27 1/4 INCHES BY 51 5/8 INCHES, WITH A THICKNESS NOT EXCEEDING 6 INCHES.

-THE MINIMUM AGE SHALL NOT BE LESS THAN 15 MONTHS OLD AND THE MAXIMUM WEIGHT SHALL NOT BE MORE THAN 50 LBS.

**DO NOT THROW THIS BOOKLET AWAY!**



**4300 Northlake Ct, Ste E, Charlotte, NC 28216**

**Phone: 980-585-1460  
www.rominafurniture.com**

# ASSEMBLY INSTRUCTIONS FOR THE ANTONIO & CLEOPATRA 6501/7501 SP & TH DAY BED OPTION

THIS CRIB CONFORMS TO APPLICABLE REGULATIONS PROMULGATED BY THE CONSUMER PRODUCT SAFETY COMMISSION AND BY THE AMERICAN SOCIETY FOR TESTING AND MATERIALS.

this picture shows what your crib should look like after completing the assembly process



**READ ALL INSTRUCTIONS BEFORE ASSEMBLING THE CRIB. KEEP THE INSTRUCTION BOOKLET FOR FURTHER USE.**

**NEVER USE THE PLASTIC SHIPPING BAGS OR OTHER PLASTIC FILM AS MATTRESS COVERS, AS THEY CAN CAUSE SUFFOCATION.**

**MAKE SURE TO SELECT THE CORRECT SIZE MATTRESS. INFANTS CAN SUFFOCATE IN THE GAPS BETWEEN THE CRIB SIDES AND A MATTRESS THAT IS TOO SMALL.**

**WARNING (FOR DAY BED OPTION ONLY):**

-ANY MATTRESS USED IN THIS CRIB MUST BE AT LEAST 27 1/4 INCHES BY 51 5/8 INCHES, WITH A THICKNESS NOT EXCEEDING 6 INCHES.

-THE MINIMUM AGE SHALL NOT BE LESS THAN 15 MONTHS OLD AND THE MAXIMUM WEIGHT SHALL NOT BE MORE THAN 50 LBS.

**DO NOT THROW THIS BOOKLET AWAY!**



**4300 Northlake Ct, Ste E, Charlotte, NC 28216**

**Phone: 980-585-1460  
www.rominafurniture.com**



**STEP A (Two adults are required in order to complete this step)**  
**BOTH 6501 & 7501**

Take your crib and carefully place it on the floor with the footboard (**FB**) facing upwards, making sure you remove any risk of damaging the finish. Using a Phillips screwdriver (which is not supplied), remove all 4 rounder head bolts and washers (**5+12**) involved in the mattress support (**MS**) fixing process and then remove the mattress support.

Remove all 4 small Allen bolt and washers (**4+9**) used to fix the footboard (**FB**). Take the footboard of your crib and carefully hold it in a vertical position, with its feet on the floor.

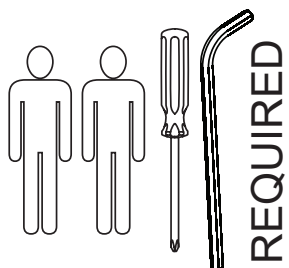
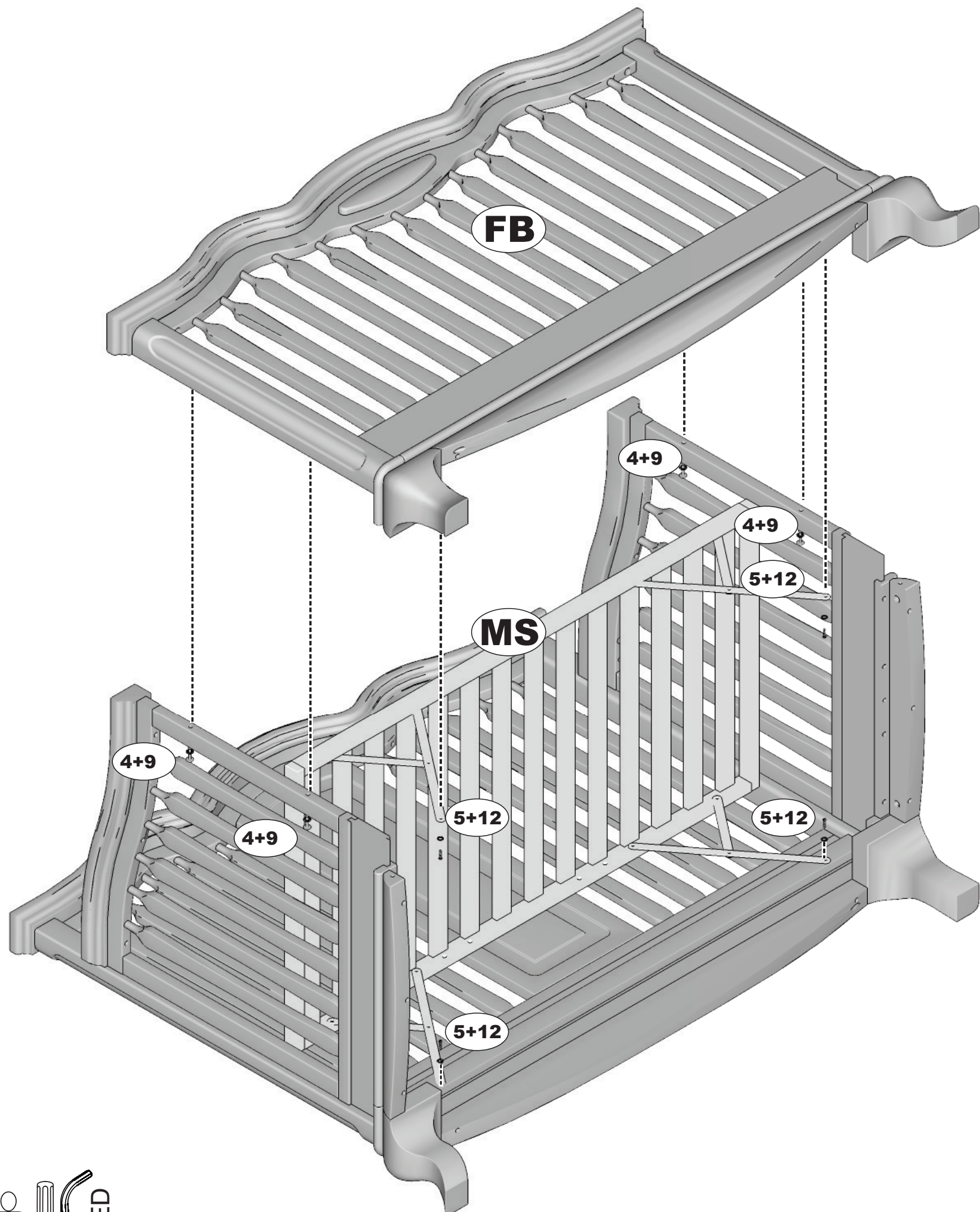
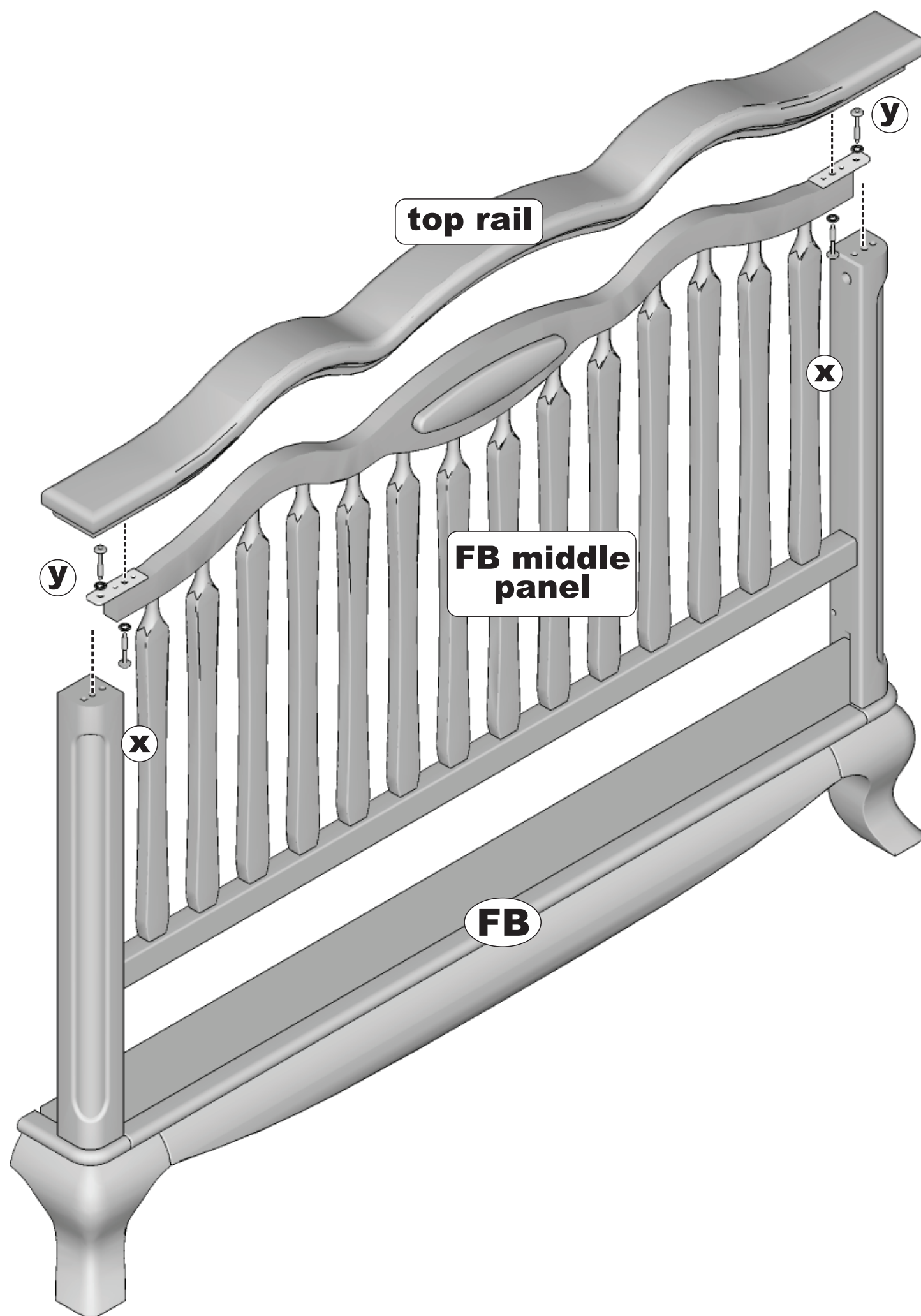
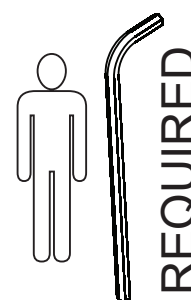

**FIGURE A**



**STEP B (Two adults are required in order to complete this step)**  
**BOTH 6501 & 7501**

Using the supplied Allen wrench (1), completely remove both Allen bolts (x) (previously mounted in the factory) then remove the **top rail**. You will find another 2 factory mounted Allen bolts (y), one for each leg of your footboard. Remove both smaller Allen bolts (y) and then the resulted **footboard middle panel** by pulling it upward (see **FIGURE B**). Please store the top rail, the middle panel and the resulted Allen bolts in a proper place, making sure the finish is not affected.



**FIGURE B**

**STEP C (One adult is required in order to complete this step)**  
**BOTH 6501 & 7501**

Using a Phillips screwdriver (which is not included) or just the hand, insert two screw-in dowels (7) into the metallic inserts holes found on each leg's top side (please see the assembly tip for correct dowel positioning).

Insert 2 cam fittings (8) into the large holes found on the wooden blocks (WB), making sure that the small arrow of the cam is pointing downwards, towards the drilled face of the wooden block (see FIGURE 3 & C for details). Using the factory mounted wooden dowls, align the wooden blocks and attach them to the legs. Afterwards, using the supplied Allen wrench (1) and moderate force, slightly rotate each cam fitting (8) clockwise (see the cam's rounded arrow) by about 90 to 120 degrees until it becomes tight.

**Do not overtighten the cams! The looseness of the cams will not affect your child's safety by any means.**

Take the supplied wooden rail (WR) and attach it to your footboard using a Phillips screwdriver (which is not supplied) and three wood screws (11).

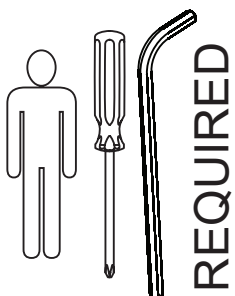
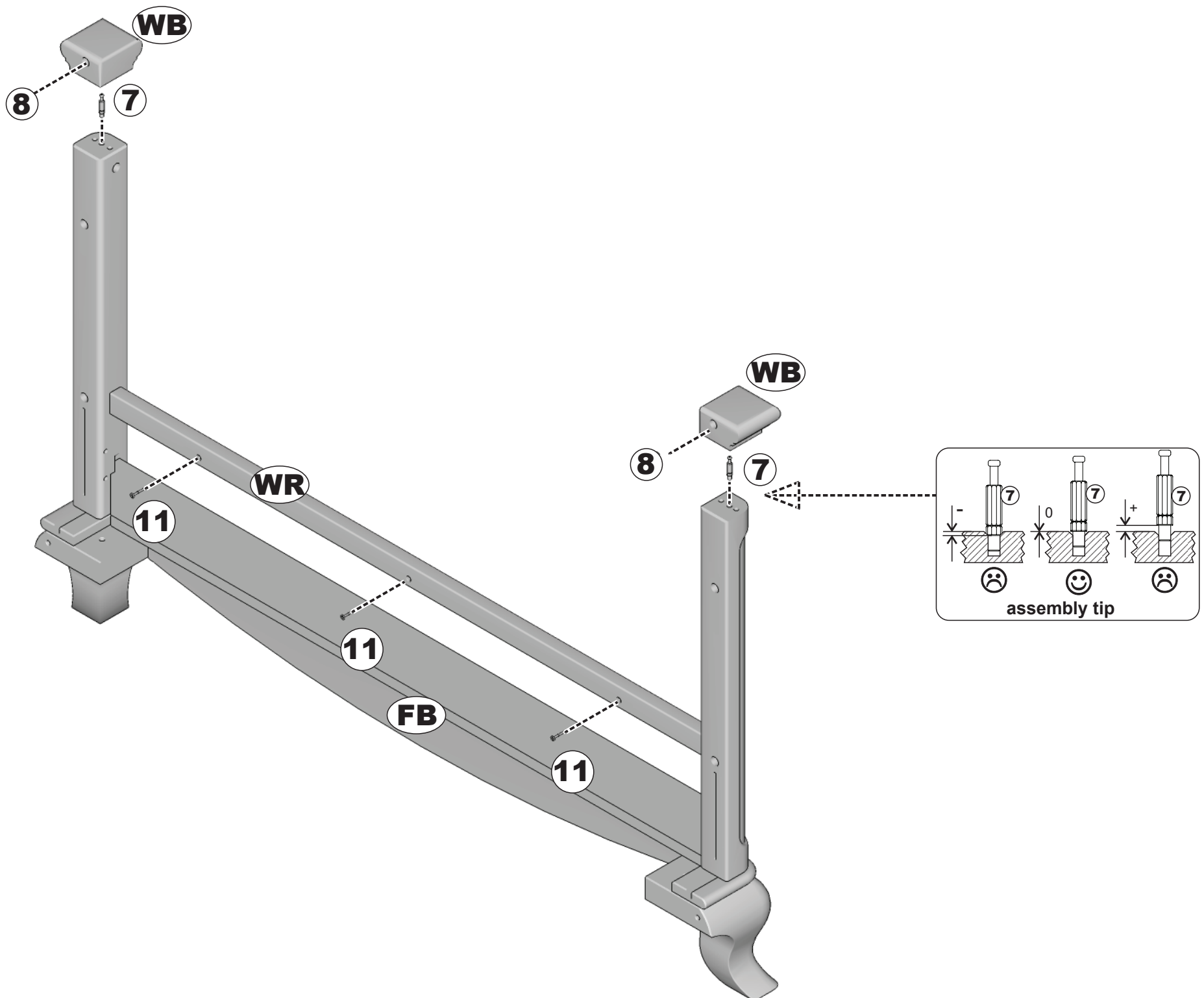

**FIGURE C**

#### STEP D

(Two adults are required in order to complete this step)  
BOTH 6501 & 7501

Take the footboard (FB) of your crib as resulted from the completion of **STEP C** and carefully place it back over the rest of the crib. Using the 4 small Allen bolts (4), 4 washers (9) and the Allen wrench supplied (1), fix the footboard to the left and right panels (LP) & (RP).

Do not completely tighten the bolts at this point, you will be asked to do so later.

#### STEP E

BOTH 6501 & 7501

Take the mattress support (MS) and adjust it to its lowest position (see **STEP 2 & ADJUSTING THE HEIGHT OF YOUR MATTRESS SUPPORT** for details). Afterwards, mount it back to the stabilizing bars (SB) using all 4 rounded head bolts (5+12) and a Phillips screddriver (which is no included). When finished, all 9 bolts (X, 5+12) involved in the mattress support installation, as well as all 4 Allen bolts remained untightened from all previous steps must be **tightened completely** by using the supplied Allen wrench and a Phillips screwdriver (which is not included).

#### REMINDER

There are a total of **16** bolts, distributed as following:

- 4 small Allen bolts (4+9) in the headboard (FB);
- 8 rounded head bolts (X, Y - factory mounted) in the mattress support (MS);
- 4 rounded head bolts (5+12) in the stabilizing bars (SB).

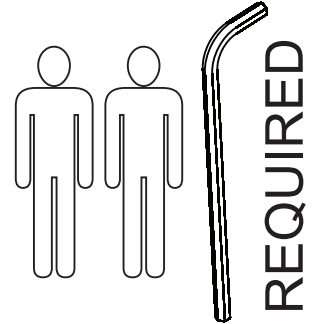

**WARNING!**  
**COMPLETELY TIGHTEN!**

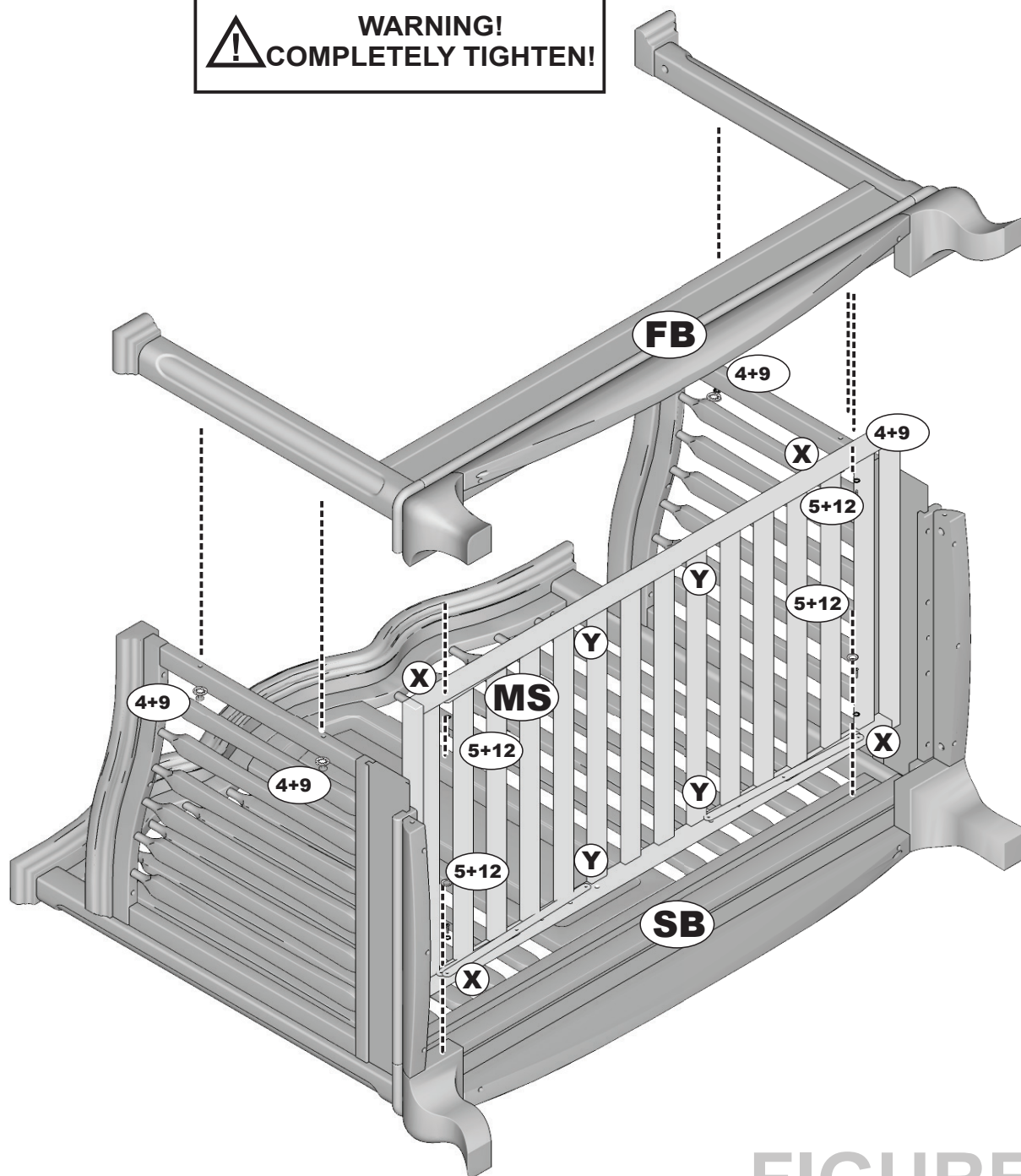

### FIGURE D

#### STEP F

(Two adults are required in order to complete this step)  
BOTH 6501 & 7501

Turn the resulted daybed the correct side up, with its feet back on the floor. After completing the assembly, your daybed should look like the one depicted on the first page of this section of the instructions manual.

**WARNING:** IN ORDER TO KEEP YOUR BABY SECURE AND SAFE AND TO AVOID POTENTIAL INJURY OR DEATH, IT IS **VERY IMPORTANT TO COMPLETELY TIGHTEN ALL 12 BOLTS LISTED IN STEP E.**



# 6501/7501 SP&TH

## TODLER RAIL OPTION

(THE TODLER RAIL IS SOLD SEPARATELY)

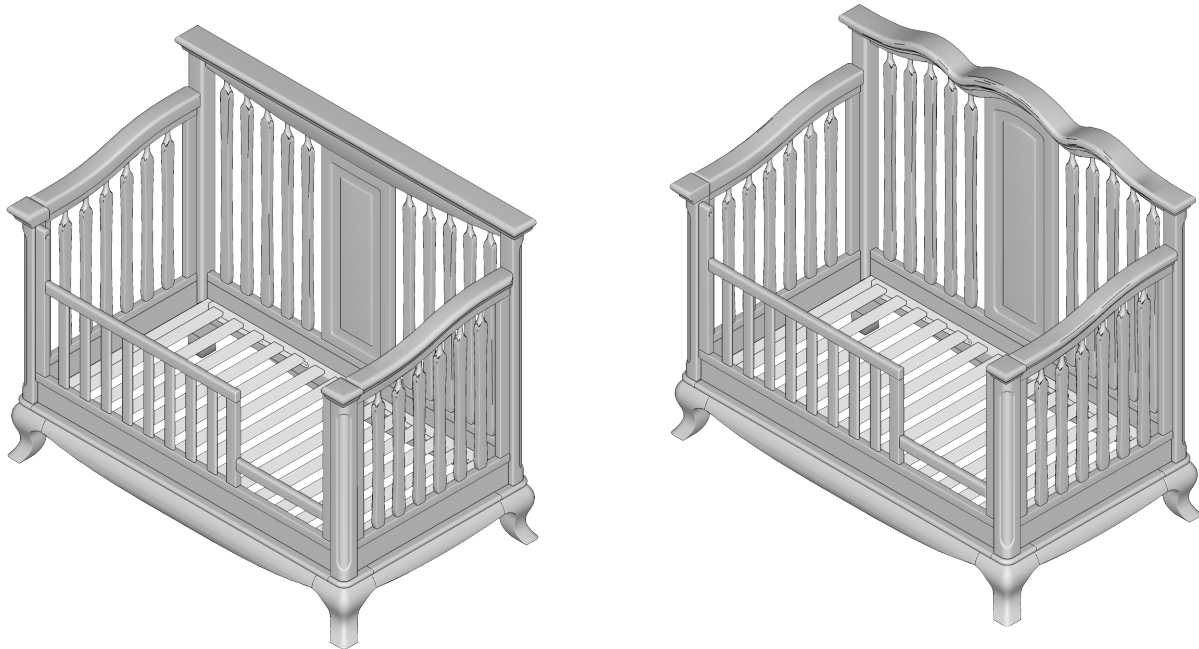

**NOTE:**

YOU CAN ATTACH A TODDLER RAIL TO YOUR CRIB WITH THE PURCHASE OF ROMINA FURNITURE ITEM **TR 7501** (TODLER RAIL 7501).

ASSEMBLY INSTRUCTIONS FOR THE TODLER RAIL CAN BE FOUND INSIDE OF THE TR 7501 PACKAGE.

PLEASE CONTACT ROMINA FURNITURE OR YOUR LOCAL DISTRIBUTOR FOR MORE INFORMATION ON THE TODLER RAIL.

# 6501/7501 SP&TH

## FULL SIZE BED OPTION

(THE CONVERSION KIT IS SOLD SEPARATELY)

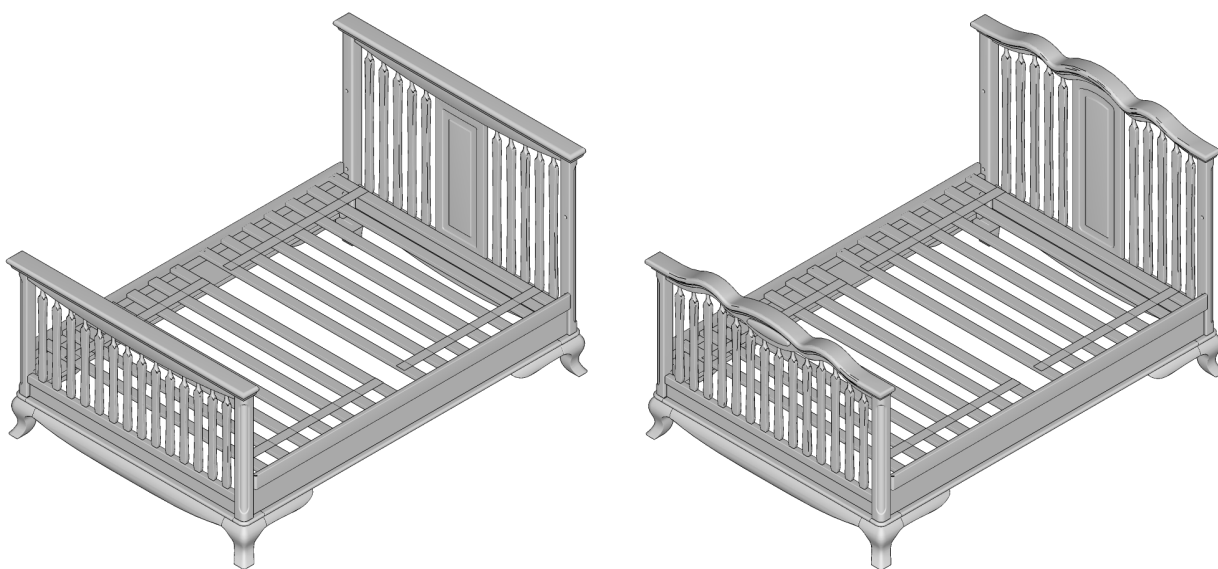

**NOTE:**

YOUR 7501 CONVERTIBLE CRIB CAN BE CONVERTED INTO A FULL SIZE BED WITH THE PURCHASE OF ROMINA ITEM CODE **CKC 7501** (CONVERSION KIT FOR CRIBS, CODE 7501).

THE ASSEMBLY INSTRUCTIONS FOR THE FULL SIZE BED OPTION CAN BE FOUND INSIDE OF THE **CKC 7501** PACKAGE.

PLEASE CONTACT ROMINA FURNITURE OR YOUR LOCAL DISTRIBUTOR FOR MORE INFORMATION ON THE CONVERSION KIT.

# CAUTION:

\*WHEN A CHILD'S HEIGHT REACHES 35 INCHES, THE CHILD SHOULD BE PLACED IN A YOUTH OR REGULAR BED.

\*USE OF A VAPORIZER NEAR FURNITURE WILL CAUSE WOOD TO SWELL AND FINISH TO PEEL.

\*DO NOT STORE CRIB IN AREAS WHERE TEMPERATURES AND CONDITIONS ARE EXTREME, SUCH AS HOT ATTICS OR COLD DAMP BASEMENTS. BOTH OF THESE EXTREME CONDITIONS MAY CAUSE THE WOOD TO CRACK AND GLUE JOINTS TO LOOSEN RESULTING IN STRUCTURAL FAILURE.

\*SHOULD IT BECOME DESIRABLE TO REFINISH THIS CRIB IN LATER YEARS, THE MANUFACTURER WARNS THAT ANY MATERIAL USED SHOULD BE NON-TOXIC. REGULAR CLEANING WITH MILD SOAP ON A SOFT CLOTH, FOLLOWED BY A CLEAN DAMP CLOTH, THEN A DRY CLOTH, WILL PRESERVE THE ORIGINAL LUSTER AND BEAUTY OF THIS FINE FINISH.

\*THIS CRIB IS NOT EQUIPPED TO HANDLE THE EXCESS WEIGHT OF A CRIB WATER MATTRESS.

\*LIFT SLIGHTLY WHEN MOVING ON CARPETING TO PREVENT LEG BREAKAGE.

**ENSURE A SAFE ENVIRONMENT FOR THE CHILD BY CHECKING REGULARLY, BEFORE PLACING THE CHILD IN THE CRIB, THAT EVERY COMPONENT IS PROPERLY AND SECURELY IN PLACE.**

## **MAINTENANCE OF YOUR ROMINA CONVERTIBLE CRIB:**

AFTER YOU FINISH ASSEMBLING YOUR CRIB, BE SURE THAT ALL BOLTS HAVE BEEN TIGHTENED SECURELY. YOU MUST CHECK ALL BOLTS PERIODICALLY AND RE-TIGHTEN AS NECESSARY. PERIODICALLY INSPECT CRIB FOR DAMAGED HARDWARE, LOOSE JOINTS OR SPLINTERED EDGES.

**DO NOT USE CRIB IF PARTS ARE DAMAGED OR BROKEN!** CONTACT YOUR DEALER OR **ROMINA FURNITURE** FOR ASSISTANCE AND REPLACEMENT PARTS. PLEASE BE SURE TO HAVE YOUR MODEL CODE WRITTEN DOWN BEFORE YOU MAKE CONTACT. THE MODEL CODE CAN BE FOUND ON A WHITE LABEL LOCATED ON THE INSIDE OF YOUR CRIB ON THE SIDE PANEL.

**NEVER SUBSTITUTE PARTS OR MAKE ALTERATIONS TO YOUR CRIB!**

**THIS PAGE WAS INTENTIONALLY LEFT  
BLANK.**



THIS PAGE WAS INTENTIONALLY LEFT  
BLANK.

**THIS PAGE WAS INTENTIONALLY LEFT  
BLANK.**

*Regular cleaning with mild soap on a soft cloth, followed by a clean damp cloth, then a dry cloth, will preserve the original luster and beauty of this fine finish of your Romina Furniture product.*



# Romina

*Furniture*

*Good life from Day 1*

*Visit*

**[www.rominafurniture.com](http://www.rominafurniture.com)**

*for updates, special offers and more new designs.*