



GABRIEL SCOTT

EST. 2012



HARLOW
Dried Flowers
Chandelier

Blackened Steel &
Alabaster White

Elegant sculptural light fixture inspired by jewelry design featuring a mold blown glass gem in a chic metallic setting.

Harlow is available in various color ways, and held in a metallic frame referencing a prong setting, the blown glass makes for a beautiful diffuser of soft light, while the prong inspired hardware adds glamour to each fixture.

All Gabriel Scott pieces are handmade in Canada.

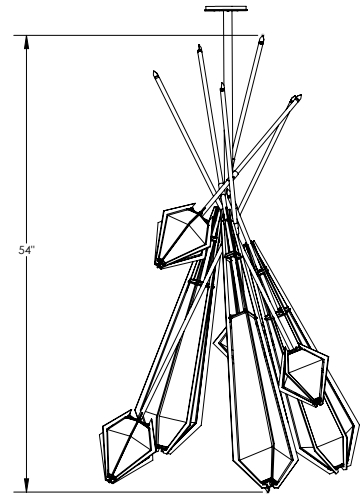
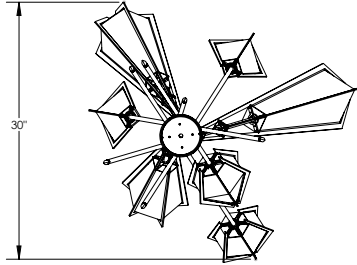
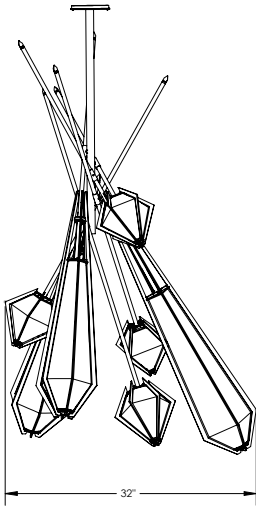

SPECIFICATIONS

Standard Finishes:

Blown Glass: Alabaster White or Smoked Gray

Metal: Blackened Steel, Satin Nickel,
Satin Brass, Satin Copper or Satin Bronze

Specifications:

Dimensions: 32" x 30" x 54" H + Stem

81 cm x 76 cm x 137 cm H + Stem

Weight: 75 lbs / 34 kg

Light Source: 12V 6 Watt LED (included)

LED Drivers: E60R12DC - 120V
UVC1250TD - 220V

Total Wattage (nominal): 21.7 w
Lumens (total): 4760 lm

Stems & Canopies:

Standard Stem Lengths: 6", 12", 18" or 24"

15 cm, 31 cm, 46 cm or 61 cm

Additional Stem Lengths: 30", 36", 42" or 48"

76 cm, 91 cm, 107 cm or 122 cm
(up-charge applies)

Standard Canopy: 5" x 0.5" / 12 cm x 1.3 cm

Deep Canopy: Dimensions on request.

Custom finishes available upon inquiry.

Made and assembled in Canada. Item is UL & CE listed.

STANDARD FINISHES

Blown Glass:



Alabaster White

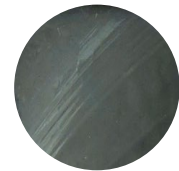

Smoked Gray

Metal:

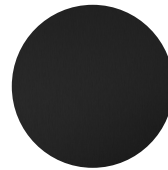

Blackened Steel

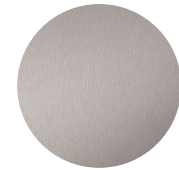

Satin Nickel



Satin Brass



Satin Copper



Satin Bronze

LED DRIVER

E60R12DC - 120V

Magnitude's E60R12DC dimmable voltage LED driver is class 2 rated and designed to operate with any standard MLV/ Incandescent TRIAC (Leading edge) dimmer switch. The driver's low profile aluminum case makes it the perfect choice for under cabinet lights, tape lights and various LED fixtures. Our electrical specification includes Auto Reset, over current and short circuit protection. Efficiency of 90% and higher allows the driver to operate at low temperatures.

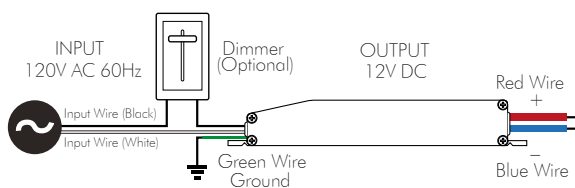
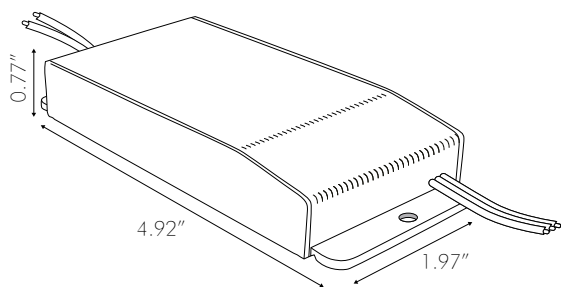

*For smooth dimming 8W minimum load is required

Features:

- Dimmable with any standard MLV/Incandescent
- TRIAC- (Leading edge) dimmer switch
- Dim down to 1%
- Super compact ALUMINUM CASE.
- Class 2
- UL 8750
- IP67 - Withstands wet and salty conditions.
- Auto-Reset Protection for short circuits & over-voltage.
- FCC 15 part 2

Specifications:

Max Load	60W
Input Voltage	120V AC
Input Current at Max Load	0.61 A
Output Voltage	12V DC
Output Current at Max load	5A
Power Factor	0.95
Efficiency	> 90 %
Operating Temp.	-20c ~ 70c (-4F ~ 158F)
Overcurrent	Yes
Over temperature	Yes
Open circuit protection	Yes
Input Wires (White / Black)	18 AWG
Output Wires (Red / Black)	14 AWG
Weight	255g
Dimensions (inches)	4.92" x 1.97" x 0.77"
Dimensions (cm)	12.5 cm x 5 cm x 1.95 cm

LED DRIVER

UVC1250TD - 220V

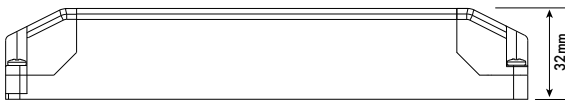
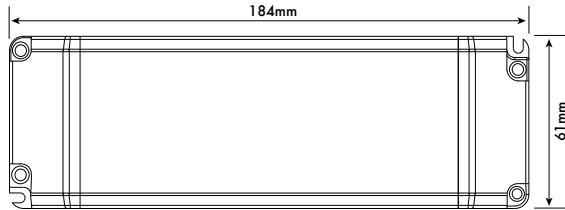

Features:

- Constant voltage output
- Fully isolated
- Short circuit, over current and over voltage protection up to 80% efficient.
- Fire resistant plastic cover
- Compatible with leading and trailing edge dimmers
- 20 ~ 100% Dimming Load and Dimming range
- Mains dimmable
- Screw terminals
- IP44 design for indoor use
- 2 years warranty

Specifications:

Part Code	UVC1250TD UVC2450TD
Voltage	220V ~ 240VAC
Frequency	50-60 Hz
Current	0.4A
Inrush Current	<2.5A
Power Factor	0.95
Load Voltage	12V
No Load Voltage	12V
Current	4.16A
Power	50W
Power Factor	>0.95
Efficiency (TYP)	>80%
Over Load	Auto-recovery
Short Circuit	Auto-recovery
Over Voltage	Auto-recovery
Operating Temperature	-20 ~ +50°C
Storage Temperature	-40 ~ +70°C
Relative Humidity	5 ~ 95%
Lifetime	50K hrs at TC max (85°C)
Connections	Screw terminal on I/P & O/P
Weight	200g
Dimensions (inches)	7.2" x 2.4" x 1.25"
Dimensions (cm)	18.4 cm x 6 cm x 3.2 cm