

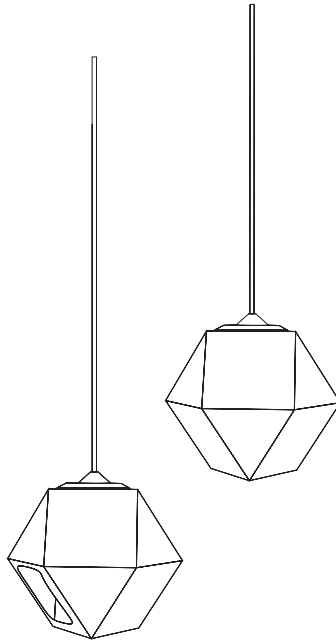

FILE#: E488971

FILE#: E503097



WELLES

Double Blown Glass Pendant Installation Guide

- Certified electrician recommended for electrical installation.
- Terminal Block not included. Installation may require advice from a qualified person.
- For all LED fixtures, use only with class 2 power unit.
- The light source contained in this luminaire shall only be replaced by the manufacturer or his service agent or a similar qualified person. Contact manufacturer for service.
- For controllable luminaires, the classification of insulation that has been maintained between LV supply and control conductors shall be provided.... basic insulation, reinforced insulation etc.
- Junction box or structural blocking rated minimum to support 50 lbs required.

*** IMPORTANT: Please provide email confirmation that your order and its related components have been received in their entirety and in good condition. Failure to do so within 7 days of delivery will waive all product warranties.**

GABRIEL SCOTT
EST 2012



Provided supplies

- Welles Glass volumes, connected in pairs
- Universal T-bar
- Socket assembly
- Installation screws

Required tools and hardware

- Screwdriver
- Drywall anchors suitable for 25lbs for mono points
- 4x 2-pole wiring terminals, screws or screwless, 12-18AWG (1.0-2.5mm²) rated for 600V, 15A / ex: WAGO 222-412
- LED driver; input: local line voltage, output: 12Vdc SELV, 5A, Max 60 watt, Class 2 LED driver

STEP 1

Shut down associated electrical breaker and wire LED driver to power source. Secure driver in junction box using provided universal T-bar

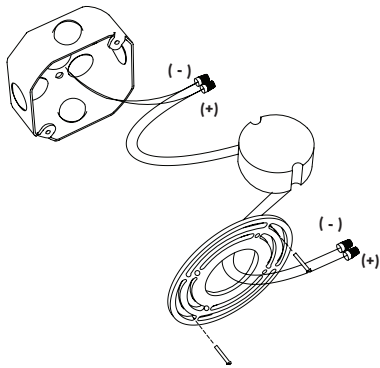

STEP 2

Gently slide the light assembly into the Welles Double Blown Glass Pendant and lock it in place with the provided glass retaining ring.

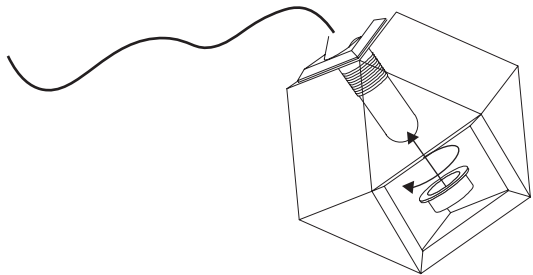

STEP 3

Pass the wire through the canopy and set the griplock so that the wire is the desired length. See next page for griplock installation.

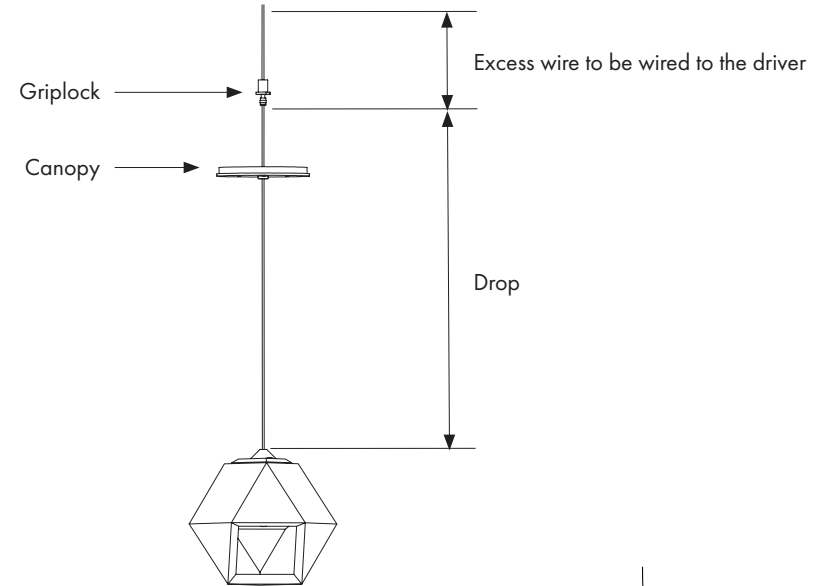

STEP 4

Using wire terminals, connect the LED driver to the fixture (Maximum distance 100'; use 12-18AWG (1.0-2.5mm²)). The outer metallic casing of the coaxial cable is Negative (-) and the black wire is Positive (+). Finally install the universal T-bar and then secure the canopy to the T-bar using the screws provided. The drop height should already be set to the correct height with a grip lock.

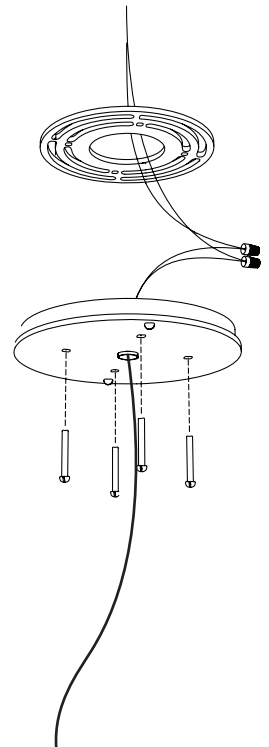

Griplock installation:

1. Pull back metal sheath

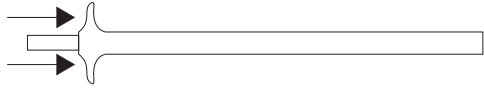

2. Trim black wire

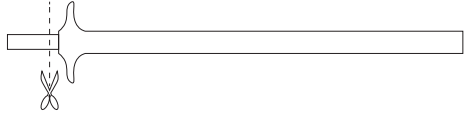

3. Twist the excess sheath so that it can be easily threaded through the canopy and griplock

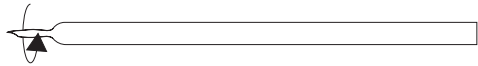

4. Set griplock to desired drop and tighten the safety nut.

