

MACHEREY-NAGEL

User manual

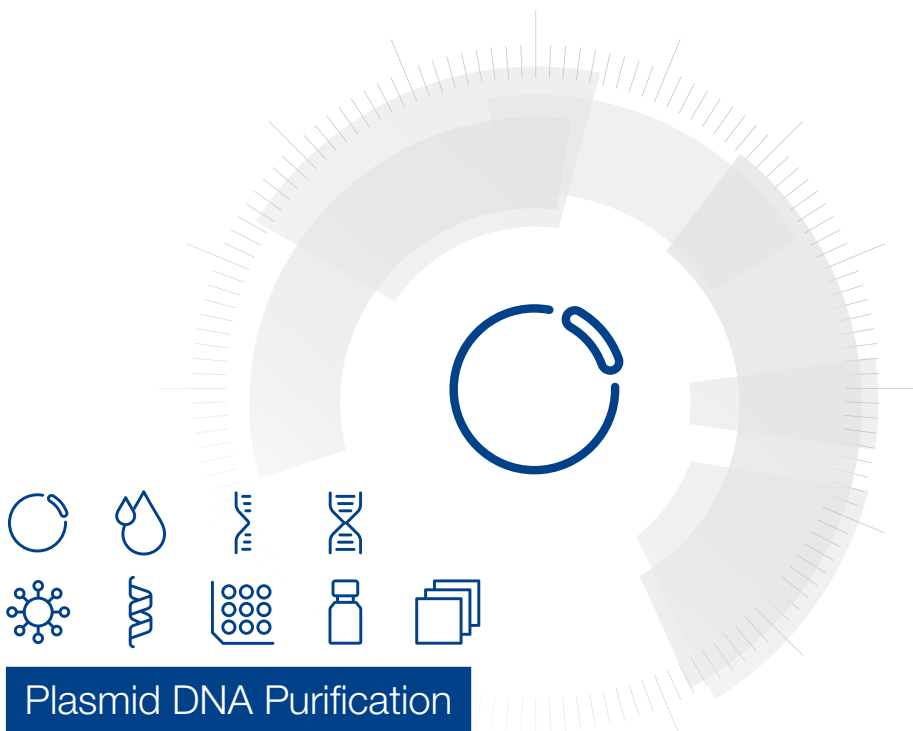

Plasmid DNA Purification

- NucleoSpin® Plasmid Transfection-grade
- NucleoSpin® 96 Plasmid Transfection-grade
- NucleoSpin® 96 Plasmid Transfection-grade Core Kit

April 2021 / Rev. 04

Contact MN

Germany and international

MACHEREY-NAGEL GmbH & Co. KG
Neumann-Neander-Str. 6-8 · 52355 Düren · Germany
Tel.: +49 24 21 969-0
Toll-free: 0800 26 16 000 (Germany only)
E-mail: info@mn-net.com

Technical Support Bioanalysis

Tel.: +49 24 21 969-270
E-mail: tech-bio@mn-net.com

USA

MACHEREY-NAGEL Inc.
924 Marcon Blvd. · Suite 102 · Allentown PA, 18109 · USA
Toll-free: 888 321 6224 (MACH)
E-mail: sales-us@mn-net.com

France

MACHEREY-NAGEL SAS
1, rue Gutenberg – BP135 · 67720 Hoerdt Cedex · France
Tel.: +33 388 68 22 68
E-mail: sales-fr@mn-net.com

MACHEREY-NAGEL SAS (Société par Actions Simplifiée) au capital de 186600 €
Siret 379 859 531 00020 · RCS Strasbourg B379859531 · N° intracommunautaire FR04 379 859 531

Switzerland

MACHEREY-NAGEL AG
Hirsackerstr. 7 · 4702 Oensingen · Switzerland
Tel.: +41 62 388 55 00
E-mail: sales-ch@mn-net.com

Table of contents

1	Components	4
1.1	Kit contents	4
1.2	Reagents, consumables, and equipment to be supplied by user	7
2	Product description	8
2.1	Basic principle	8
2.2	Kit specifications	8
2.3	Required hardware	9
2.4	Recommended accessories for use of the NucleoSpin® 96 Plasmid Transfection-grade Core Kit	9
2.5	Automated processing on robotic platforms	11
2.6	Growth of bacterial cultures	11
2.7	Elution procedures	12
3	Storage conditions and preparation of working solutions	13
4	Safety instructions	15
5	Protocols	17
5.1	Isolation of transfection-grade plasmid DNA in low throughput (REF 740490)	17
5.2	Isolation of high-copy plasmid DNA using a NucleoVac 24 Vacuum Manifold	19
5.3	Isolation of transfection-grade plasmid DNA in high throughput (REF 740491, REF 740492)	22
5.3.1	Manual vacuum processing	22
5.3.2	Elution of DNA using a centrifuge	30
6	Appendix	31
6.1	Troubleshooting	31
6.2	Ordering information	34
6.3	Product use restriction/ warranty	36

1 Components

1.1 Kit contents

REF	NucleoSpin® Plasmid Transfection-grade		
	10 preps 740490.10	50 preps 740490.50	250 preps 740490.250
Resuspension Buffer A1	5 mL	15 mL	75 mL
Lysis Buffer A2	15 mL	15 mL	100 mL
Neutralization Buffer A3	5 mL	20 mL	100 mL
Detoxification Buffer ERB	13 mL	50 mL	200 mL
Wash Buffer AQ (Concentrate)*	6 mL	2 x 6 mL	2 x 25 mL
Elution Buffer AE**	13 mL	13 mL	60 mL
RNase A (lyophilized)*	2.5 mg	6 mg	30 mg
NucleoSpin® Plasmid TG Columns (blue rings)	10	50	250
Collection Tubes (2 mL)	10	50	250
User manual	1	1	1

* For preparation of working solutions and storage conditions see section 3.

** Composition of Elution Buffer AE: 5 mM Tris/HCl, pH 8.5

NucleoSpin® 96 Plasmid Transfection-grade			
REF	1 x 96 preps 740491.1	4 x 96 preps 740491.4	24 x 96 preps* 740491.24
Resuspension Buffer A1	75 mL	150 mL	6 x 150 mL
Lysis Buffer A2	100 mL	150 mL	6 x 150 mL
Neutralization Buffer A3	100 mL	200 mL	6 x 200 mL
Detoxification Buffer ERB	125 mL	400 mL	6 x 400 mL
Wash Buffer AQ (Concentrate)**	100 mL	2 x 100 mL	12 x 100 mL
Elution Buffer AE***	30 mL	125 mL	6 x 125 mL
RNase A (lyophilized)**	30 mg	60 mg	6 x 60 mg
NucleoSpin® Plasmid Filter Plate (violet rings)	1	4	24
NucleoSpin® Plasmid Binding Plate (white rings)	1	4	24
Culture Plate (including Gas-permeable Foil)	1	4	24
MN Wash Plate	1	4	24
Elution Plate (including Self-adhering PE Foil)	1	4	24
User manual	1	1	6

* The kit for 24 x 96 preparations (REF 740491.24) consists of 6 x 740491.4.

** For preparation of working solutions and storage conditions see section 3.

*** Composition of Elution Buffer AE: 5 mM Tris/HCl, pH 8.5

NucleoSpin® 96 Plasmid Transfection-grade Core Kit		
REF	4 x 96 preps 740492.4	24 x 96 preps* 740492.24
Resuspension Buffer A1	150 mL	6 x 150 mL
Lysis Buffer A2	150 mL	6 x 150 mL
Neutralization Buffer A3	200 mL	6 x 200 mL
Detoxification Buffer ERB	400 mL	6 x 400 mL
Wash Buffer AQ (Concentrate)**	2 x 100 mL	12 x 100 mL
Elution Buffer AE***	125 mL	6 x 125 mL
RNase A (lyophilized)**	60 mg	6 x 60 mg
NucleoSpin® Plasmid Filter Plate (violet rings)	4	24
NucleoSpin® Plasmid Binding Plate (white rings)	4	24
User manual	1	6

* The kit for 24 x 96 preparations (REF 740492.24) consists of 6 x 740492.4.

** For preparation of working solutions and storage conditions see section 3.

*** Composition of Elution Buffer AE: 5 mM Tris/HCl, pH 8.5

1.2 Reagents, consumables, and equipment to be supplied by user

Reagents

- 96–100% ethanol

Consumables

- 1.5 mL microcentrifuge tubes for sample lysis and DNA elution

Equipment

- Centrifuge for microcentrifuge tubes (for REF 740490 only)
- NucleoVac 96 Vacuum Manifold (see ordering information) or vacuum based liquid handler (for REF 740491 and REF 740792 only)

2 Product description

2.1 Basic principle

The **NucleoSpin® Plasmid Transfection-grade** procedure is a modified version of the Birnboim and Doly¹ alkaline lysis plasmid miniprep protocol. Pelleted bacteria are resuspended in Buffer A1 and plasmid DNA is liberated from the cells by SDS/alkaline Lysis Buffer A2. Buffer A3 neutralizes the lysate, precipitates genomic DNA, proteins and cell debris, and creates appropriate conditions for binding of plasmid DNA to the silica membrane.

The crude lysate is cleared either by centrifugation (REF 740490) or filtration (REF 740491, REF 740492) and brought into contact with a silica membrane where plasmid DNA binds to the surface. Endotoxins and proteins are removed by the innovative Detoxification Buffer ERB. Further contaminations such as salts are removed with ethanolic Buffer AQ while traces of ethanol are removed by centrifugation (REF 740490) or vacuum (REF 740491, REF 740492).

Pure plasmid DNA is eluted under low ionic strength conditions with slightly alkaline Buffer AE (5 mM Tris/HCl, pH 8.5) and is ready for any common downstream application including transfection (research use only).

2.2 Kit specifications

The **NucleoSpin® Plasmid Transfection-grade** and **NucleoSpin® 96 Plasmid Transfection-grade** kits are designed for the rapid manual or automated small-scale purification of transfection-grade plasmid DNA from *E. coli*.

The **NucleoSpin® 96 Plasmid Transfection-grade** kits allow for easy automation on common liquid handling instruments. For more information about the automation process and the availability of ready-to-run scripts for certain platforms please refer to section 2.5 and/ or contact your local distributor or MN directly.

All technical literature is available on the internet at www.mn-net.com.

Please contact Technical Service regarding information about changes of the current user manual compared to previous revisions.

¹ Birnboim, H.C. & Doly, J. (1979) *Nucleic Acids Res.* 7, 1513-1523

Table 1: Kit specifications at a glance

Parameter	NucleoSpin® Plasmid Transfection-grade	NucleoSpin® 96 Plasmid Transfection-grade
Format	Mini spin columns	96-well plates
Processing	Manual, centrifugation or vacuum	Manual or automated, vacuum or centrifugation
Sample material	≤ 5 mL <i>E. coli</i> culture	≤ 5 mL <i>E. coli</i> culture
Vector size	< 25 kbp	< 25 kbp
Elution volume	30–50 µL	100–200 µL
Preparation time	25 min/18 preps	45 min/plate
Binding capacity	35 µg	35 µg
Endotoxin level	< 50 EU/µg DNA	< 50 EU/µg DNA

2.3 Required hardware

This **NucleoSpin® 96 Plasmid Transfection-grade** kits are intended for use under vacuum. A support protocol for elution under centrifugation is included (see section 5.3.2).

A support protocol for complete processing under centrifugation is available from our technical service (tech-bio@mn-net.com).

The **NucleoSpin® 96 Plasmid Transfection-grade** kits can be used manually with the NucleoVac 96 Vacuum Manifold (see Ordering information, section 6.2). Additionally, a suitable centrifuge for harvesting the bacteria (either plate or tube centrifuge) and for the optimal elution step under centrifugation is required.

2.4 Recommended accessories for use of the NucleoSpin® 96 Plasmid Transfection-grade Core Kit

The **NucleoSpin® 96 Plasmid Transfection-grade Core Kit** provides buffers, RNase A, and NucleoSpin® Filter / Binding Plates. Accessory plates (e.g., culture blocks, elution plates) are not provided with the core kit. The user can individually select additional consumables from a variety of suitable accessory plates according to his requirements for highest flexibility.

For use of **NucleoSpin® 96 Plasmid Transfection-grade Core Kit**, follow the standard protocols (see section 5.3.1 or 5.3.2, respectively).

Recommended accessories for use of the **NucleoSpin® 96 Plasmid Transfection-grade Core Kit** are available from MACHEREY-NAGEL (see Ordering information, section 6.2).

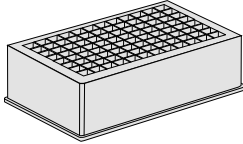
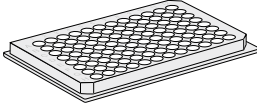
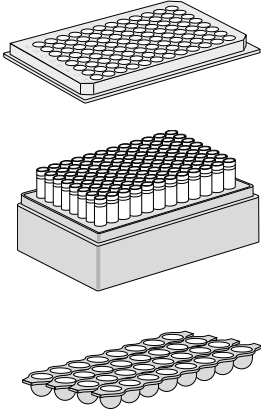
Protocol step	Suitable consumables, not supplied with the core kits	Remarks
Cultivate bacteria	Culture plate 	Square-well Blocks with Gaspermeable Foil
Wash silica membrane	MN Wash Plate 	MN Wash Plate minimizes the risk of cross contamination (vacuum processing only)
Elute DNA	Elution Plate U-bottom or Rack of Tube Strips (including Cap Strips) 	Not suitable for elution by centrifugation

2.5 Automated processing on robotic platforms

NucleoSpin® 96 Plasmid Transfection-grade can be used fully automated on many common laboratory workstations. For the availability of scripts and general considerations about adaptations to a certain workstation, please contact MN. Full processing under vacuum enables complete automation without the need of centrifugation steps, regarding the drying of the membrane and the elution step.

Drying of the NucleoSpin® Plasmid Binding Plate under vacuum is sufficient because the bottom of the plate is protected from residues of wash buffer during the washing steps by the MN Wash Plate. As a result, we recommend trying to integrate the MN Wash Plate into the automated procedure. The MN Frame (see Ordering information, section 6.2) can be used to position the disposable MN Wash Plate inside the vacuum chamber. Thorough cleaning of the vacuum chamber is recommended after each run to prevent forming of DNA containing aerosols.

Visit MN online at www.mn-net.com or contact your local MACHEREY-NAGEL distributor for technical support regarding hardware, software, setup, instructions and selection of the protocol.

2.6 Growth of bacterial cultures

Plasmid yield and quality highly depend on the bacterial culture which is influenced by many factors.

Besides culture medium, selective antibiotic, bacterial host strain and type of plasmid, the oxygen availability is of crucial importance for bacterial growth. Anaerobic metabolism of nutrients will result in suboptimal energy uptake and accumulation of organic acids as metabolic end products which inhibit further cell growth.

When incubating bacterial cultures in small volumes with limited surface (like in the Culture Plates, supplied with the **NucleoSpin® 96 Plasmid Transfection-grade** kits), take care to shake the plates vigorously (200–400 rpm) to maintain a proper aeration of the culture. In order to avoid cross contamination due to spillage during incubation, cover the Culture Plate with the supplied Gas-permeable Foil. Do not exceed a total culture volume of 1.5 mL when working with the Culture Plates. If an increased total culture volume is desired, it is possible to grow bacteria in several Culture Plates with identical layout or in 24 well plates. Either way take care not to exceed the total resuspension volume of 250 µL per sample. The total volume of 250 µL per sample may either be split into the corresponding amount of plates and pooled after resuspension or the total amount may directly be dispensed into a first plate and completely transferred to succeeding plates after resuspension.

The **NucleoSpin® Plasmid Transfection-grade** kits are optimized for the purification of plasmid DNA from up to 5 mL bacterial culture with an OD_{600} of 3 or up to 3 mL of a culture with an OD_{600} of 5. Using significantly more bacteria will overload the lysis capacity and result in reduced yield.

2.7 Elution procedures

Elution efficiency depends on vector size and elution volume.

The single spin kit is optimized for an elution volume of 50 μL . A higher concentration without losses in recovery might be achieved by a second elution with the first eluate as elution buffer. To directly gain higher concentrations, the elution volume may be reduced to 30 μL .

Elution under vacuum as performed in the HTP kit is more prone to losses in elution volume. See Figure 1 for the correlation between elution volume, eluted volume, recovery, and concentration.

- Recovered DNA, μg
- ◆ Concentration, $\text{ng}/\mu\text{L}$
- ▲ Recovery, %

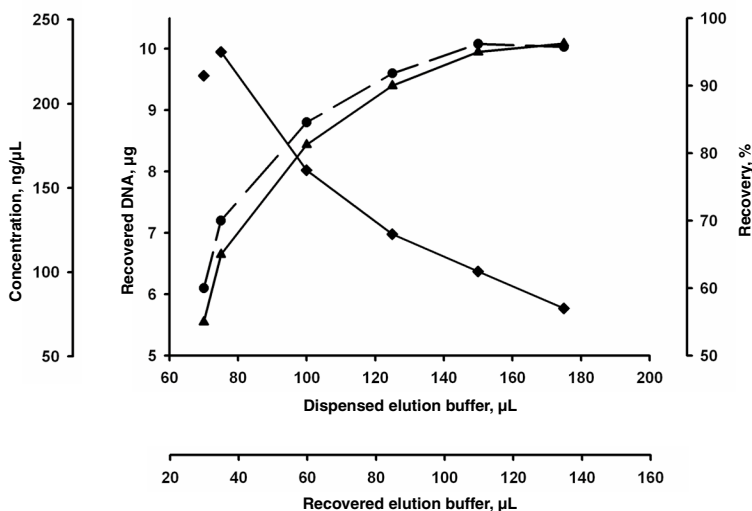

Figure 1: Recovery rate and concentration depend on elution volume.

10 μg of pBluescript plasmid were purified with NucleoSpin® 96 Plasmid and eluted with the indicated elution buffer volumes.

3 Storage conditions and preparation of working solutions

Attention: Buffer A3 contains guanidine hydrochloride! Wear gloves and goggles!

CAUTION: Buffer A3 contains guanidine hydrochloride which can form highly reactive compounds when combined with bleach (sodium hypochloride). DO NOT add bleach or acidic solutions directly to the sample preparation waste.

- All kit components can be stored at 15–25 °C and are stable for at least one year.
- Always keep buffer bottles tightly closed.
- Sodium dodecyl sulfate (SDS) in **Buffer A2** may precipitate if stored at temperatures below 20 °C. Precipitated SDS might form a firm layer at the bottom of the bottle which is difficult to see from the side or above. Invert the bottle carefully several times (avoid extensive foaming) and check the bottom and solution for white flocculates. If a precipitate is observed in Buffer A2, incubate bottle at 30–40 °C for several minutes and mix well.
- Buffer ERB may form crystals if stored at temperatures below 20 °C. The crystals have to be redissolved by heating to 50–60 °C whilst shaking. The bottle should be closed during the heat incubation at all times. Before starting the extraction process, the ERB buffer must be cooled down to room-temperature.

Before starting any **NucleoSpin® (96) Plasmid Transfection-grade** protocol, prepare the following:

- Add 3 mL of **Buffer A1** to the **RNase A** vial and mix by vortexing or pipetting up and down until the RNase A is resuspended completely. Transfer the solution back into the Buffer A1 bottle and mix thoroughly. Indicate date of RNase A addition and mark the corresponding checkbox of Buffer A1. Store Buffer A1 containing RNase A at 4 °C. The solution will be stable at this temperature for at least six months.
- Add the indicated volume of 96–100% ethanol to **Buffer AQ**.

NucleoSpin® Plasmid Transfection-grade			
REF	10 preps 740490.10	50 preps 740490.50	250 preps 740490.250
Wash Buffer AQ (Concentrate)	6 mL Add 24 mL ethanol	2 x 6 mL Add 24 mL ethanol to each bottle	2 x 25 mL Add 100 mL ethanol to each bottle

NucleoSpin® 96 Plasmid Transfection-grade

REF	1 x 96 prep 740491.1	4 x 96 preps 740491.4	24 x 96 preps 740491.24
Wash Buffer AQ (Concentrate)	100 mL Add 400 mL ethanol	2 x 100 mL Add 400 mL ethanol to each bottle	12 x 100 mL Add 400 mL ethanol to each bottle

NucleoSpin® 96 Plasmid Transfection-grade Core Kit





REF	4 x 96 preps 740492.4	24 x 96 preps 740492.24
Wash Buffer AQ (Concentrate)	2 x 100 mL Add 400 mL ethanol	12 x 100 mL Add 400 mL ethanol to each bottle

4 Safety instructions

The following components of the **NucleoSpin® 96 Plasmid Transfection-grade** kits contain hazardous contents.

Wear gloves and goggles and follow the safety instructions given in this section.

Only harmful features do not need to be labeled with H and P phrases up to 125 mL or 125 g. *Mindergefährliche Eigenschaften müssen bis 125 mL oder 125 g nicht mit H- und P-Sätzen gekennzeichnet werden.*

Component	Hazard contents	GHS symbol	Hazard phrases	Precaution phrases
<i>Inhalt</i>	<i>Gefahrstoff</i>	<i>GHS-Symbol</i>	<i>H-Sätze</i>	<i>P-Sätze</i>
A2 (with LyseControl)	Sodium hydroxide solution 0.5–1 % <i>Natriumhydroxid-Lösung</i> 0.5–1 % CAS 1310-73-2d	 WARNING <i>ACHTUNG</i>	315, 319	280sh
A3	Guanidine hydrochloride 36–50 % <i>Guanidinhydrochlorid</i> 36–50 % CAS 50-01-1	 WARNING <i>ACHTUNG</i>	302, 319	264W, 280sh, 301+312, 330
ERB	2-Propanol 35–50 % <i>2-Propanol</i> 35–50 % CAS 67-63-0	 WARNING <i>ACHTUNG</i>	226, 319, 336	210, 260D, 280sh
RNase A	RNase 90–100 % <i>RNase</i> 90–100 % CAS 9001-99-4	 DANGER <i>GEFAHR</i>	334	261sh, 342+311

Hazard phrases

H 226	Flammable liquid and vapour. <i>Flüssigkeit und Dampf entzündbar.</i>
H 302	Harmful if swallowed. <i>Gesundheitsschädlich bei Verschlucken.</i>
H 315	Causes skin irritation. <i>Verursacht Hautreizungen.</i>
H 319	Causes serious eye irritation. <i>Verursacht schwere Augenreizung.</i>
H 334	May cause allergy or asthma symptoms or breathing difficulties if inhaled. <i>Kann bei Einatmen Allergie, asthmaartige Symptome oder Atembeschwerden verursachen.</i>
H 336	May cause drowsiness or dizziness. <i>Kann Schläfrigkeit und Benommenheit verursachen.</i>

Precaution phrases

- P 210 Keep away from heat, hot surfaces, sparks, open flames and other ignition sources. No smoking.
Von Hitze, heissen Oberflächen, Funken, offenen Flammen sowie anderen Zündquellenarten fernhalten. Nicht rauchen.
- P 260D Do not breathe vapors.
Dampf nicht einatmen.
- P 261sh Avoid breathing dust/vapors.
Einatmen von Staub/Dampf vermeiden.
- P 264W Wash with water thoroughly after handling.
Nach Gebrauch mit Wasser gründlich waschen.
- P 280sh Wear protective gloves/eye protection.
Schutzhandschuhe/Augenschutz tragen
- P 301+312 IF SWALLOWED: Call a POISON CENTER / doctor if you feel unwell.
BEI VERSCHLUCKEN: Bei Unwohlsein GIFTINFORMATIONSZENTRUM/Arzt anrufen.
- P 330 Rinse mouth.
Mund ausspülen.
- P 342+311 If experiencing respiratory symptoms: Call a POISON CENTER / doctor.
Bei Symptomen der Atemwege: GIFTINFORMATIONSZENTRUM/Arzt anrufen.



The symbol shown on labels refers to further safety information in this section.
Das auf Etiketten dargestellte Symbol weist auf weitere Sicherheitsinformationen dieses Kapitels hin.

5 Protocols

5.1 Isolation of transfection-grade plasmid DNA in low throughput (REF 740490)

Before starting the preparation:

- Check if RNase A was added to Buffer A1 according to section 3.
- Check Lysis Buffer A2 for precipitated SDS according to section 3.
- Check if Wash Buffer AQ was prepared according to section 3.

1 Cultivate and harvest bacterial cells

Use **1–5 mL** of a saturated **E. coli** culture, pellet cells in a standard benchtop microcentrifuge for **30 s** at **11,000 x g**. Discard the supernatant and remove as much of the liquid as possible.



11,000 x g,
30 s



2 Lyse cells

Add **250 µL Buffer A1**. **Resuspend** the cell pellet completely by vortexing or pipetting up and down. Make sure no cell clumps remain before addition of Buffer A2!

+ 250 µL A1

Resuspend

Add **250 µL Buffer A2**. **Mix** gently by inverting the tube **6–8 times**. Do not vortex or pipette to avoid shearing of genomic DNA.



+ 250 µL A2

Mix

+ 300 µL A3

Mix

Add **300 µL Buffer A3**. **Mix** thoroughly by **inverting the tube until the blue color disappeared completely** and an off-white precipitate has formed. Do not vortex to avoid shearing of genomic DNA.

3 Clarify lysate

Centrifuge for **10 min** at **full speed** at room temperature.



Full speed,
10 min

Repeat this step in case the supernatant is not clear!

4 Bind DNA

Place a **NucleoSpin® Plasmid TG Column** in a Collection Tube (2 mL) and decant or pipette the supernatant from step 3 onto the column. Make sure not to transfer cell debris as this results in a higher endotoxin concentration of the eluates.



Load
supernatant

11,000 x g,
1 min



Centrifuge for **1 min** at **11,000 x g**. Discard flow-through and place the NucleoSpin® Plasmid TG Column back into the Collection Tube.

5 Wash silica membrane

1st wash

Add **700 µL Buffer ERB**. Centrifuge for **1 min** at **11,000 x g**. Discard flow-through and place the NucleoSpin® Plasmid TG Column back into the Collection Tube.



+ 700 µL ERB

**11,000 x g,
1 min**

2nd wash

Add **650 µL Buffer AQ**. Centrifuge for **1 min** at **11,000 x g**. Discard flow-through and place the NucleoSpin® Plasmid TG Column back into the empty Collection Tube.



+ 650 µL AQ

**11,000 x g,
1 min**

6 Dry silica membrane

Centrifuge for **1 min** at **11,000 x g** and discard the Collection Tube.



**11,000 x g,
1 min**

7 Elute DNA

Place the NucleoSpin® Plasmid TG Column in a 1.5 mL microcentrifuge tube (not provided) and add **50 µL Buffer AE**. Incubate for **1 min** at **room temperature**. Centrifuge for **1 min** at **11,000 x g**.

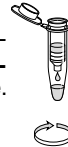

+ 50 µL AE

RT, 1 min

**11,000 x g,
1 min**

5.2 Isolation of high-copy plasmid DNA using a NucleoVac 24 Vacuum Manifold

1 Cultivate and harvest bacterial cells

Use **1–5 mL** of a saturated *E. coli* culture and pellet cells in a standard benchtop microcentrifuge for **30 s** at **11,000 x g**. Discard supernatant and remove as much of the liquid as possible.



1–5 mL *E. coli* culture



**11,000 x g,
30 s**

2 Lyse cells

Add **250 µL Buffer A1**. **Resuspend** the cell pellet completely by vortexing or pipetting up and down. Make sure no cell clumps remain before addition of Buffer A2!



**+ 250 µL A1
Resuspend**

Attention: Check Buffer A2 for precipitated SDS prior to use. If a white precipitate is visible, warm the buffer for several minutes at 30–40 °C until any precipitate is dissolved. Mix thoroughly and cool buffer down to room temperature (18–25 °C).



**+ 250 µL A2
Mix gently
RT, 5 min**

Add **250 µL Buffer A2**. Mix gently by inverting the tube **6–8 times**. Do not vortex to avoid shearing of genomic DNA. Incubate at room temperature for a maximum of **5 min** or until the lysate appears clear.



**+ 350 µL A3
Mix**

Add **350 µL Buffer A3**. Mix thoroughly by inverting the tube **until the blue samples turn colorless completely!** Do not vortex to avoid shearing of genomic DNA!

3 Clarify lysate

Centrifuge for **10 min** at **> 11,000 x g** at **room temperature**.



Repeat this step in case the supernatant is not clear!



**11,000 x g,
10 min**

* Reduction of atmospheric pressure

4 Bind DNA

Place a **NucleoSpin® Plasmid TG Column** onto a suitable vacuum manifold with Luer-connections like the NucleoVac 24 Vacuum Manifold and **load up to 700 µL supernatant**. Do not close the lid!



Load supernatant

Apply vacuum of **-0.2 to -0.4 bar* (1 min)**.

-0.2 to -0.4 bar*, 1 min

When the sample has passed the NucleoSpin® Plasmid TG Column, release the vacuum.

If necessary, load remaining sample and repeat the step.

5 Wash silica membrane

Add **700 µL Buffer ERB**. Apply vacuum of **-0.2 to -0.4 bar* (1 min)**. When the buffer has passed the NucleoSpin® Plasmid TG Column, release the vacuum.



+ 700 µL ERB

Add **650 µL Buffer AQ** (supplemented with ethanol, see section 3). Apply vacuum of **-0.2 to -0.4 bar* (1 min)**.

-0.2 to -0.4 bar*, 1 min

When the buffer has passed the NucleoSpin® Plasmid TG Column, release the vacuum.



+ 650 µL AQ

-0.2 to -0.4 bar*, 1 min

* Reduction of atmospheric pressure

6 Dry silica membrane

Option 1: Drying by vacuum



-0.4 to -0.6 bar*, 5 min

Apply vacuum of **-0.4 to -0.6 bar*** for **5 min** to remove **Buffer AQ** completely. Run the vacuum pump continuously. Achieving and keeping a continuous air flow is more important than reaching the exact mentioned reduction of atmospheric pressure. Do not close the lid!

Release the vacuum.

Option 2: Drying by centrifugation

Place the NucleoSpin® Plasmid TG Column into a Collection Tube (2 mL). Centrifuge for **1 min** at **11,000 x g** to remove Buffer AQ completely. Make sure the spin column does not come in contact with the flow-through while removing it from the centrifuge and the collection tube.



11,000 x g, 1 min

Note: Residual ethanol from Buffer AQ might inhibit enzymatic reactions. Total removal of ethanol can be achieved by incubating the columns for 2–5 min at 70 °C prior to elution.

7 Elute DNA

Place the NucleoSpin® Plasmid TG Column into a new 1.5 mL microcentrifuge tube (not provided).



+ 50 µL AE

Add **50 µL Buffer AE** and incubate at **room temperature** (18–25 °C) for **1 min**. Centrifuge for **1 min** at **11,000 x g**.

RT, 1 min



11,000 x g, 1 min

* Reduction of atmospheric pressure

5.3 Isolation of transfection-grade plasmid DNA in high throughput (REF 740491, REF 740492)

5.3.1 Manual vacuum processing

- For hardware requirements, refer to section 2.3.
- For detailed information regarding the vacuum manifold setup, see page 24–25.
- For use of the NucleoSpin® 96 Plasmid Core Kit (REF 740492.4/24), refer to section 2.4 regarding recommended accessories.

For processing of the **NucleoSpin® 96 Plasmid Transfection-grade** under vacuum the NucleoVac 96 Vacuum Manifold is required (see Ordering information, section 6.2).

Before starting the preparation:

- Check if RNase A was added to Buffer A1 according to section 3.
- Check Lysis Buffer A2 for precipitated SDS according to section 3.
- Check if Wash Buffer AQ was prepared according to section 3.
- Set up the vacuum according to the scheme.

Protocol-at-a-glance

1	Cultivate and harvest bacterial cells	1.5–5 mL LB or up to 2.5 mL 2x YT or TB 10 min, 1,000 x g
2	Resuspend bacterial cells	250 µL A1 Mix or shake
3	Lyse bacterial cells	250 µL A2 RT, 2–5 min Shake
4	Neutralize	350 µL A3 Mix or shake Prepare vacuum manifold for lysate clearing step
5	Transfer crude lysate to NucleoSpin® Plasmid Filter Plate (violet rings)	

6	Clear crude lysate by vacuum filtration directly into the NucleoSpin® Plasmid Binding Plate (white rings)	-0.2–0.4 bar*, 1–5 min
7	Reassemble vacuum manifold Discard NucleoSpin® Plasmid Filter Plate Remove NucleoSpin® Plasmid Binding Plate with cleared lysates and insert MN Wash Plate Place the NucleoSpin® Plasmid Binding Plate on top of the manifold	
8	Bind DNA to silica membrane of the NucleoSpin® Plasmid Binding Plate by applying vacuum	-0.2–0.4 bar*, 1 min
9	Wash silica membrane	900 µL ERB 900 µL AQ 900 µL AQ -0.2 to -0.4 bar*, 1 min each step
10	Remove MN Wash Plate	
11	Dry NucleoSpin® Plasmid Binding Plate by applying vacuum <i>Optional: Dry the outlets of the NucleoSpin® Plasmid Binding Plate by placing it on a sheet of filter paper before applying vacuum</i>	Full vacuum, 10–15 min (run pump continuously)
12	Insert Elution Plate U-bottom	
13	Elute plasmid DNA	150 µL AE RT, 3 min Increasing vacuum

* Reduction of atmospheric pressure

Setup of vacuum manifold: Lysate clearing

Lysate clearing

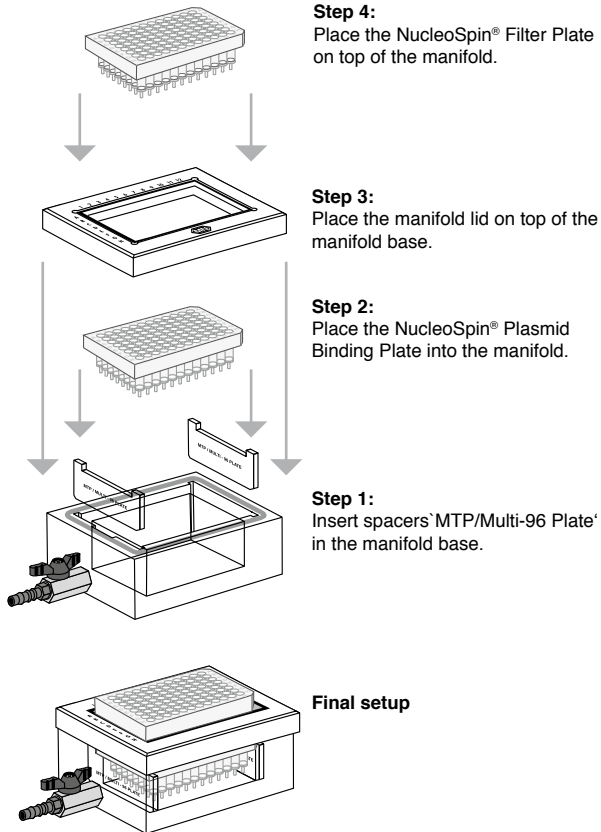

Setup of vacuum manifold: Binding / Washing / Elution steps

Binding / Washing steps

Elution step

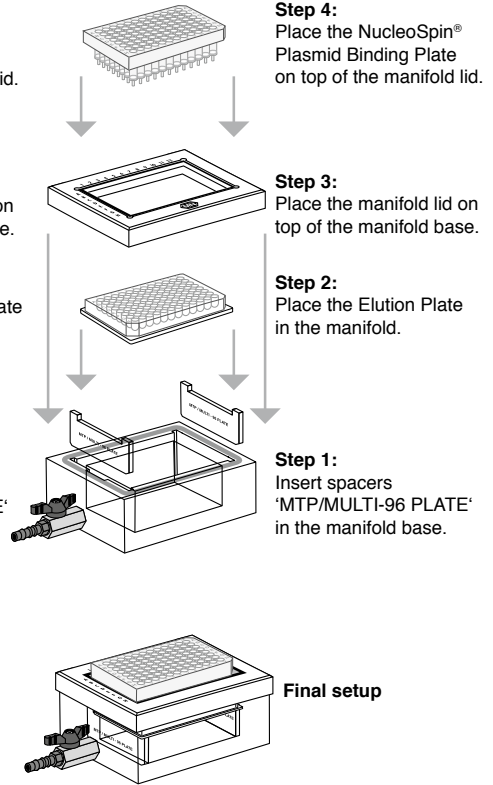
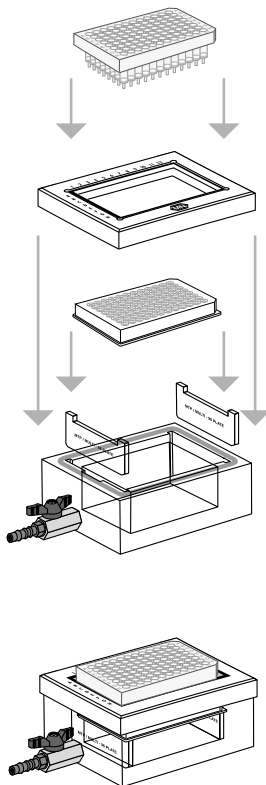

Detailed protocol

For processing of the **NucleoSpin® 96 Plasmid Transfection-grade** under vacuum the NucleoVac 96 Vacuum Manifold is required (see Ordering information, section 6.2).

Before starting the preparation:

- Check if RNase A was added to Buffer A1 according to section 3.
- Check Lysis Buffer A2 for precipitated SDS according to section 3.
- Check if Wash Buffer AQ was prepared according to section 3.
- Set up the vacuum according to the scheme.

1 Cultivate and harvest bacterial cells

Centrifuge the bacterial cultures for **10 min** at **1,000 x g**.

Centrifugation at higher *g*-forces might produce tight pellets which are more difficult to resuspend.

Discard supernatant. Remove residual medium by tapping tube or plate upside down on a clear paper sheet or soft tissue.

2 Resuspend bacterial cells

Add **250 µL Buffer A1 with RNaseA**. Resuspend the cell pellet completely by vortexing or mixing by pipetting up and down. Resuspend bacterial cells completely before addition of Buffer A2!

3 Lyse bacterial cells

Add **250 µL Buffer A2**. Do not vortex or pipette to avoid shearing of genomic DNA.

Incubate at **room temperature** for a maximum of **5 min** with moderate shaking (300 rpm). Do not allow the lysis reaction to proceed for more than 5 min.

4 Neutralize

Add **350 µL Buffer A3**. Mix by pipetting up and down. Do not vortex to avoid shearing of genomic DNA.

Prepare the NucleoVac 96 Vacuum Manifold

Prepare the manifold for filtration of crude lysates:

Insert spacers labeled 'MTP/Multi-96 Plate' notched side up into the grooves located on the short side of the manifold base. Insert waste container into manifold base. Place the NucleoSpin® Plasmid Binding Plate (white rings) on top of the spacers. Insert the NucleoSpin® Plasmid Filter plate (violet rings) into the manifold lid and place the lid on the manifold base. Close the manifold base with the manifold lid.

5 Transfer crude lysates onto the NucleoSpin® Plasmid Filter Plate

Transfer crude lysates from step 4 carefully and completely into the wells of the NucleoSpin® Plasmid Filter Plate.

Note: Mix the suspension by pipetting up and down the entire volume once before transfer to the NucleoSpin® Plasmid Filter Plate.

6 Clear crude lysate by vacuum filtration

Apply vacuum of **-0.2 to -0.4 bar* (1–5 min)**. If necessary, press down the NucleoSpin® Plasmid Filter Plate slightly until flow-through starts. Adjust vacuum to establish a flow rate of 1–2 drops per second.

When the crude lysate has passed the NucleoSpin® Plasmid Filter Plate, release the vacuum.

7 Reassemble vacuum manifold

Remove and discard the NucleoSpin® Plasmid Filter Plate. Open the manifold lid. Remove the NucleoSpin® Plasmid Binding Plate (white rings) with cleared lysates.

Insert waste container into manifold base. Insert the MN Wash Plate onto the spacers inside the manifold base. Close the manifold base with the manifold lid. Place the NucleoSpin® Plasmid Binding Plate on top of the manifold.

8 Bind DNA to silica membrane

Apply vacuum of **-0.2 to -0.4 bar* (1 min)**.

When the cleared lysate has passed the NucleoSpin® Plasmid Binding Plate, release the vacuum.

* Reduction of atmospheric pressure

9 Washes silica membrane

1st wash

Add **900 µL Buffer ERB** to each well. Apply vacuum of **-0.2 to -0.4 bar* (1 min)**.

Release the vacuum once the buffer has passed all wells.

2nd wash

Add **900 µL Buffer AQ** to each well. Apply vacuum of **-0.2 to -0.4 bar* (1 min)**.

Release the vacuum once the buffer has passed all wells.

3rd wash

Repeat the wash step with **900 µL Buffer AQ**. Apply vacuum of **-0.2 to -0.4 bar* (1 min)**.

Release the vacuum once the buffer has passed all wells.

10 Remove MN Wash Plate

After the final washing step, remove the NucleoSpin® Plasmid Binding Plate. Remove manifold lid, MN Wash Plate, and waste container from the vacuum manifold.

11 Dry silica membrane

Remove any residual wash buffer from the NucleoSpin® Plasmid Binding Plate. If necessary, tap the outlets of the plate onto a clean paper sheet (supplied with the MN Wash Plate) or soft tissue.

Close the manifold base with the manifold lid. Place the NucleoSpin® Plasmid Binding Plate on top of the manifold.

Apply vacuum of **-0.4 to -0.6 bar*** for **10 min** to dry the membrane completely. Run the vacuum pump continuously. Achieving and keeping a continuous air flow is of more importance than reaching the precise mentioned reduction of atmospheric pressure.

Release the vacuum.

12 Insert Elution Plate U-bottom

Remove the manifold lid with the NucleoSpin® Plasmid Binding Plate from the vacuum manifold. Insert the Elution Plate U-bottom on the spacers inside the manifold base. Close the manifold base with the manifold lid. Place the NucleoSpin® Plasmid Binding Plate on top of the manifold.

* Reduction of atmospheric pressure

13 Elute DNA

Elute the DNA by adding **150 µL Buffer AE** (150 µL is recommended, 100–200 µL is possible, see section 2.4) or sterile and endotoxin-free H₂O-EF (not supplied, has to be ordered separately, see section 6.2 for ordering information) to each well of the NucleoSpin® Plasmid Binding Plate.

The elution buffer should be dispensed carefully onto the center of the silica membrane. Incubate the buffer on the membrane for **3 min at room temperature**.

Carefully **apply vacuum** by a **steady increase of vacuum force** under visual control of the eluates in the elution plate. Take care not to generate an air flow which is too forceful as spilling of eluates might lead to cross-contamination and loss of DNA.

For more convenient elution, the Rack of Tube Strips is recommended (not supplied, see ordering information in section 6.2).

5.3.2 Elution of DNA using a centrifuge

Elution of purified DNA in a centrifuge can be performed when higher concentrations of the final DNA are required for downstream applications. Using a centrifuge allows the dispensed volume of elution buffer to be reduced down to 50–75 µL.

Required hardware:

- For centrifugation, a microtiterplate centrifuge that can accommodate the NucleoSpin® Plasmid Binding Plate stacked on a Rack of Tube Strips is required (bucket height: 85 mm). It is also necessary that the centrifuge reaches accelerations of at least 4,000 x g.
- Suitable elution tubes: Rack of Tube Strips have to be ordered separately (see Ordering information, section 6.2).

1 Stop the method after the final washing step with **Buffer AQ**. Remove the NucleoSpin® Plasmid Binding Plate from the manifold's top and tap on a sheet of filter paper to remove residual wash buffer from the outlets.

2 Place the NucleoSpin® Plasmid Binding Plate on top of a MN Square-well Block (not supplied, see ordering information) and centrifuge for **5 min at maximum speed (> 4,000 x g)**.

Note: Do not use a microtiter plate as a support for the NucleoSpin® Plasmid Binding Plate. Microtiter plates may crack.

3 Place the NucleoSpin® Plasmid Binding Plate on top of a Rack of Tube Strips. Elute the DNA by adding **75 µL Buffer AE** (75 µL is recommended, 50–150 µL is possible) or sterile and endotoxin-free H₂O-EF (not supplied, has to be ordered separately, see ordering information) to each well of the NucleoSpin® Plasmid Binding Plate.

The elution buffer should be dispensed carefully onto the center of the silica membrane. Incubate the buffer on the membrane for **3 min at room temperature**.

4 Centrifuge for **2 min at maximum speed (> 4,000 x g)** to collect the plasmid DNA.

Remove the Rack of Tube Strips containing eluted DNA and close them with Cap Strips for further storage.

6 Appendix

6.1 Troubleshooting

Problem	Possible cause and suggestions
Incomplete lysis of bacterial cells	<i>Cell pellet not properly resuspended</i> <ul style="list-style-type: none">It is essential that the cell pellet is completely resuspended prior to lysis. No cell clumps should be visible before addition of Buffer A2. Use the centrifugation speed and times given in the manual to avoid tight pellets.
	<i>SDS in Buffer A2 precipitated</i> <ul style="list-style-type: none">SDS in Buffer A2 may precipitate upon storage. If this happens a white precipitate is visible at the bottom of the bottle. Incubate Buffer A2 at 30–40 °C for several minutes and mix well before use.
	<i>Too many bacterial cells used</i> <ul style="list-style-type: none">Usage of LB as the growth medium is recommended. When using rich media like 2 x YT or TB, cultures may reach very high cell densities. Reduce culture volume.

Problem	Possible cause and suggestions
	<p><i>Incomplete lysis of bacterial cells</i></p> <ul style="list-style-type: none">• See “Possible cause and suggestions” above
	<p><i>No plasmid contained in bacteria</i></p> <ul style="list-style-type: none">• Cells carrying the plasmid of interest may become overgrown by non-transformed cells due to insufficient amounts of selective antibiotics.• Do not incubate cultures for more than 16 h as this may result in many dead and starving cells with degraded DNA.
	<p><i>Use of low-copy plasmid</i></p> <ul style="list-style-type: none">• Getting acceptable plasmid yields for transfection requires high-copy plasmids in a miniprep scale or a switch to large scale kits (NucleoBond® Xtra Midi/ Maxi).
Poor plasmid yield	<p><i>Suboptimal elution conditions</i></p> <ul style="list-style-type: none">• Elution efficiency will decrease with larger constructs. When working with large constructs, the elution buffer volume should be increased or the elution process repeated with the previous eluate as new elution buffer.• Silica and DNA bound thereto can be overdried by excess vacuum. Reduce vacuum force or time during the drying step and increase incubation times of Buffer AE. <p><i>Eluate spillage</i></p> <ul style="list-style-type: none">• Increase the vacuum force carefully when eluting the DNA into Elution Plates U-bottom. Watch the eluates while increasing the vacuum force. <p><i>Buffer AQ not prepared correctly</i></p> <ul style="list-style-type: none">• Add the indicated amount of 96–100% ethanol to each bottle of Buffer AQ. Keep bottles closed tightly to prevent evaporation.

Problem	Possible cause and suggestions
Genomic DNA contamination	<p><i>Excessive mixing steps</i></p> <ul style="list-style-type: none"> Cell lysate was vortexed or mixed too vigorously after addition of Buffer A2 or Buffer A3. Genomic DNA was sheared and thus liberated. REF 740491 and REF 740792 only: Reduce number of mixing cycles, reduce shaker speed after addition of Lysis Buffer A2 and Neutralization Buffer A3 or before transfer of crude lysates to the NucleoSpin® Plasmid Filter Plate. Mixing will cause shearing of chromosomal DNA, leading to a copurification during the preparation of plasmid DNA. Use wide bore disposable tips for transfer of crude lysate to the NucleoSpin® Plasmid Filter plate to prevent shearing of chromosomal DNA.
	<p><i>Lysis was too long</i></p> <ul style="list-style-type: none"> Lysis was too long and must not exceed 5 min.
RNA contamination	<p><i>RNA was not degraded completely</i></p> <ul style="list-style-type: none"> Ensure that RNase A was added to Buffer A1 and mixed well before use.
Suboptimal performance in downstream applications	<p><i>Carry-over of ethanol</i></p> <ul style="list-style-type: none"> Make sure that the outlets do not come into contact with Buffer AQ after the drying step.
	<p><i>RNA contamination</i></p> <ul style="list-style-type: none"> RNA might influence the photometric measurements resulting in an overestimation of plasmid DNA. Make sure RNase A is added to Buffer A1.

6.2 Ordering information

Product	REF	Pack of
NucleoSpin® Plasmid	740490.10	10 preps
Transfection-grade	740490.50	50 preps
	740490.250	250 preps
NucleoSpin® 96 Plasmid	740491.1	1 x 96 preps
Transfection-grade	740491.4	4 x 96 preps
	740491.24	24 x 96 preps
NucleoSpin® 96 Plasmid	740492.4	4 x 96 preps
Transfection-grade Core Kit	740492.24	24 x 96 preps
NucleoSpin® 96 Plasmid	740625.1	1 x 96 preps
	740625.4	4 x 96 preps
	740625.24	24 x 96 preps
NucleoSpin® 96 Plasmid Core Kit	740616.4	4 x 96 preps
	740616.24	24 x 96 preps
Buffer A1 (without RNase A)	740911.1	1 L
Buffer A2 without Lyse Control	740912.1	1 L
Buffer A2 with LyseControl	740328.100	100 mL
Buffer A3	740913.1	1 L
Buffer AQ (Concentrate) (for 125 mL Buffer AQ)	740995	25 mL
H ₂ O-EF	740798.1	1 L
RNase A (lyophilized)	740505	100 mg
	740505.50	50 mg
Collection Tubes (2 mL)	740600	1000
NucleoVac 96 Vacuum Manifold	740681	1
NucleoVac 24 Vacuum Manifold	740299	1
NucleoVac Vacuum Regulator	740641	1
Rack of Tube Strips (1 set consists of 1 rack, 12 strips with 8 tubes each and 12 Cap Strips)	740477	4 sets
	740477.24	24 sets
Cap Strips	740478	48
	740478.24	288

Product	REF	Pack of
MN Square-well Block	740476	4
	740476.24	24
MN Wash Plate	740479	4
	740479.24	24
Culture Plate (with Gas-permeable Foil)	740488	4 sets
	740488.24	24 sets
Elution Plate U-bottom (with Self-adhering Foil)	740486.24	24 sets
Gas-permeable Foil	740675	50
Self-adhering Foil	740676	50
MN Frame	740680	1

Visit www.mn-net.com for more detailed product information.

6.3 Product use restriction/ warranty

NucleoSpin® Plasmid Transfection-grade kit components are intended, developed, designed, and sold FOR RESEARCH PURPOSES ONLY, except, however, any other function of the product being expressly described in original MACHEREY-NAGEL product leaflets.

MACHEREY-NAGEL products are intended for GENERAL LABORATORY USE ONLY! MACHEREY-NAGEL products are suited for QUALIFIED PERSONNEL ONLY! MACHEREY-NAGEL products shall in any event only be used wearing adequate PROTECTIVE CLOTHING. For detailed information please refer to the respective Material Safety Data Sheet of the product! MACHEREY-NAGEL products shall exclusively be used in an ADEQUATE TEST ENVIRONMENT. MACHEREY-NAGEL does not assume any responsibility for damages due to improper application of our products in other fields of application. Application on the human body is STRICTLY FORBIDDEN. The respective user is liable for any and all damages resulting from such application.

DNA/RNA/PROTEIN purification products of MACHEREY-NAGEL are suitable for IN VITRO-USES ONLY!

ONLY MACHEREY-NAGEL products specially labeled as IVD are also suitable for IN VITRO-diagnostic use. Please pay attention to the package of the product. IN VITRO-diagnostic products are expressly marked as IVD on the packaging.

IF THERE IS NO IVD SIGN, THE PRODUCT SHALL NOT BE SUITABLE FOR IN VITRO-DIAGNOSTIC USE!

ALL OTHER PRODUCTS NOT LABELED AS IVD ARE NOT SUITED FOR ANY CLINICAL USE (INCLUDING, BUT NOT LIMITED TO DIAGNOSTIC, THERAPEUTIC AND/OR PROGNOSTIC USE).

No claim or representations is intended for its use to identify any specific organism or for clinical use (included, but not limited to diagnostic, prognostic, therapeutic, or blood banking). It is rather in the responsibility of the user or - in any case of resale of the products - in the responsibility of the reseller to inspect and assure the use of the DNA/RNA/protein purification products of MACHEREY-NAGEL for a well-defined and specific application.

MACHEREY-NAGEL shall only be responsible for the product specifications and the performance range of MN products according to the specifications of in-house quality control, product documentation and marketing material.

This MACHEREY-NAGEL product is shipped with documentation stating specifications and other technical information. MACHEREY-NAGEL warrants to meet the stated specifications. MACHEREY-NAGEL's sole obligation and the customer's sole remedy is limited to replacement of products free of charge in the event products fail to perform as warranted. Supplementary reference is made to the general business terms and conditions of MACHEREY-NAGEL, which are printed on the price list. Please contact us if you wish to get an extra copy.

There is no warranty for and MACHEREY-NAGEL is not liable for damages or defects arising in shipping and handling (transport insurance for customers excluded), or

out of accident or improper or abnormal use of this product; defects in products or components not manufactured by MACHEREY-NAGEL, or damages resulting from such non-MACHEREY-NAGEL components or products.

MACHEREY-NAGEL makes no other warranty of any kind whatsoever, and SPECIFICALLY DISCLAIMS AND EXCLUDES ALL OTHER WARRANTIES OF ANY KIND OR NATURE WHATSOEVER, DIRECTLY OR INDIRECTLY, EXPRESS OR IMPLIED, INCLUDING, WITHOUT LIMITATION, AS TO THE SUITABILITY, REPRODUCTIVITY, DURABILITY, FITNESS FOR A PARTICULAR PURPOSE OR USE, MERCHANTABILITY, CONDITION, OR ANY OTHER MATTER WITH RESPECT TO MACHEREY-NAGEL PRODUCTS.

In no event shall MACHEREY-NAGEL be liable for claims for any other damages, whether direct, indirect, incidental, compensatory, foreseeable, consequential, or special (including but not limited to loss of use, revenue or profit), whether based upon warranty, contract, tort (including negligence) or strict liability arising in connection with the sale or the failure of MACHEREY-NAGEL products to perform in accordance with the stated specifications. This warranty is exclusive and MACHEREY-NAGEL makes no other warranty expressed or implied.

The warranty provided herein and the data, specifications and descriptions of this MACHEREY-NAGEL product appearing in MACHEREY-NAGEL published catalogues and product literature are MACHEREY-NAGEL's sole representations concerning the product and warranty. No other statements or representations, written or oral, by MACHEREY-NAGEL's employees, agent or representatives, except written statements signed by a duly authorized officer of MACHEREY-NAGEL are authorized; they should not be relied upon by the customer and are not a part of the contract of sale or of this warranty.

Product claims are subject to change. Therefore please contact our Technical Service Team for the most up-to-date information on MACHEREY-NAGEL products. You may also contact your local distributor for general scientific information. Applications mentioned in MACHEREY-NAGEL literature are provided for informational purposes only. MACHEREY-NAGEL does not warrant that all applications have been tested in MACHEREY-NAGEL laboratories using MACHEREY-NAGEL products. MACHEREY-NAGEL does not warrant the correctness of any of those applications.

Last updated: 07/2010, Rev. 03

Please contact:
MACHEREY-NAGEL GmbH & Co. KG
Tel.: +49 24 21 969-270
tech-bio@mn-net.com

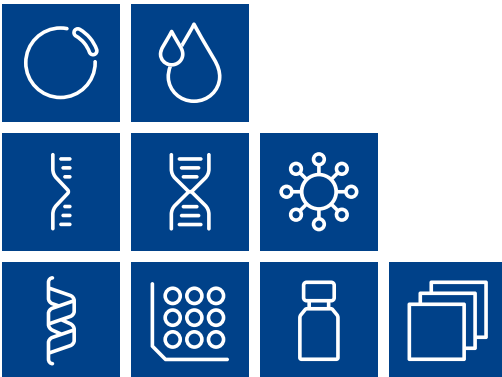

Plasmid DNA

Clean up

RNA

DNA

Viral RNA and DNA

Protein

High throughput

Accessories

Auxiliary tools

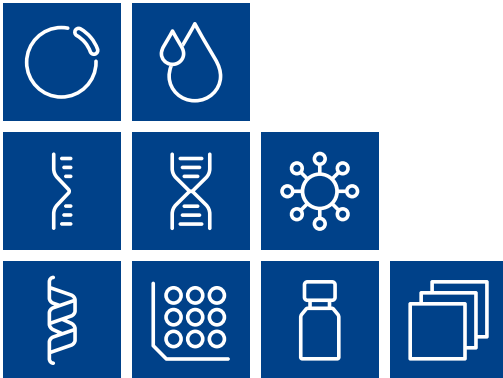

www.mn-net.com

MACHEREY-NAGEL



MACHEREY-NAGEL GmbH & Co. KG
Neumann-Neander-Str. 6-8
52355 Düren · Germany

DE	Tel.: +49 24 21 969-0	info@mn-net.com
CH	Tel.: +41 62 388 55 00	sales-ch@mn-net.com
FR	Tel.: +33 388 68 22 68	sales-fr@mn-net.com
US	Tel.: +1 888 321 62 24	sales-us@mn-net.com