

Versiv™ Series

Cabling Certification Product Family

Users Manual

Versiv Software Version 6.2

February 2018, Rev. 5 5/2019

©2018-2019 Fluke Corporation

All product names are trademarks of their respective companies.

LIMITED WARRANTY AND LIMITATION OF LIABILITY

Each Fluke Networks product is warranted to be free from defects in material and workmanship under normal use and service unless stated otherwise herein. The warranty period for the mainframe is one year and begins on the date of purchase. Parts, accessories, product repairs and services are warranted for 90 days, unless otherwise stated. Ni-Cad, Ni-MH and Li-Ion batteries, cables or other peripherals are all considered parts or accessories. The warranty extends only to the original buyer or end user customer of a Fluke Networks authorized reseller, and does not apply to any product which, in Fluke Networks' opinion, has been misused, abused, altered, neglected, contaminated, or damaged by accident or abnormal conditions of operation or handling. Fluke Networks warrants that software will operate substantially in accordance with its functional specifications for 90 days and that it has been properly recorded on non-defective media. Fluke Networks does not warrant that software will be error free or operate without interruption.

Fluke Networks authorized resellers shall extend this warranty on new and unused products to end-user customers only but have no authority to extend a greater or different warranty on behalf of Fluke Networks. Warranty support is available only if product is purchased through a Fluke Networks authorized sales outlet or Buyer has paid the applicable international price. To the extent permitted by law, Fluke Networks reserves the right to invoice Buyer for repair/replacement when a product purchased in one country is submitted for repair in another country.

For a list of authorized resellers, visit www.flukenetworks.com/wheretobuy.

Fluke Networks warranty obligation is limited, at Fluke Networks option, to refund of the purchase price, free of charge repair, or replacement of a defective product which is returned to a Fluke Networks authorized service center within the warranty period. To obtain warranty service, contact your nearest Fluke Networks authorized service center to obtain return authorization information, then send the product to that service center, with a description of the difficulty, postage and insurance prepaid (FOB destination). Fluke Networks assumes no risk for damage in transit. Following warranty repair, the product will be returned to Buyer, transportation prepaid (FOB destination). If Fluke Networks determines that failure was caused by neglect, misuse, contamination, alteration, accident or abnormal condition of operation or handling, or normal wear and tear of mechanical components, Fluke Networks will provide an estimate of repair costs and obtain authorization before commencing the work. Following repair, the product will be returned to the Buyer transportation prepaid and the Buyer will be billed for the repair and return transportation charges (FOB Shipping point).

THIS WARRANTY IS BUYER'S SOLE AND EXCLUSIVE REMEDY AND IS IN LIEU OF ALL OTHER WARRANTIES, EXPRESS OR IMPLIED, INCLUDING BUT NOT LIMITED TO ANY IMPLIED WARRANTY OF MERCHANTABILITY OR FITNESS FOR A PARTICULAR PURPOSE. FLUKE NETWORKS SHALL NOT BE LIABLE FOR ANY SPECIAL, INDIRECT, INCIDENTAL OR CONSEQUENTIAL DAMAGES OR LOSSES, INCLUDING LOSS OF DATA, ARISING FROM ANY CAUSE OR THEORY.

Since some countries or states do not allow limitation of the term of an implied warranty, or exclusion or limitation of incidental or consequential damages, the limitations and exclusions of this warranty may not apply to every buyer. If any provision of this Warranty is held invalid or unenforceable by a court or other decision-maker of competent jurisdiction, such holding will not affect the validity or enforceability of any other provision.

Contents

Chapter 1 Get Acquainted

Overview of Features	1
Versiv 2 Compatibility	2
Contact Fluke Networks	2
Register Your Product	3
Technical Reference Handbook	3
Additional Resources	3
Supplements and Updated Manuals	3
Kit Contents	3
Symbols	4
 Safety Information	5
For the Main and Remote Units	5
For DSX Modules	8
For CertiFiber Pro OLTS Modules	9
For OptiFiber Pro OTDR Modules	10
AC Adapter and Battery	12
Charge the Battery	12
Check the Battery Status	14
Verify Operation	15
How to Use the Touchscreen	17
Change the Language	19
Buttons to Do Tests and Save Results	19
Options for Cable IDs	20
How to Install a Strap	22
How to Remove or Install a Module	22

About LinkWare Applications	24
LinkWare PC Cable Test Management Software ...	24
The LinkWare Live Web Application	24
LinkWare Stats	24

Chapter 2 Certify Twisted Pair Cabling

Overview of Features	25
Connectors, Keys, and LEDs	26
About Link Interface Adapters	30
Adapters for DSX-8000 and DSX-5000 Modules	32
The DSX CableAnalyzer Home Screen	33
Make Sure Your Tester is Ready to Certify Cabling	36
Set the Reference	36
Settings for Twisted Pair Tests	38
How to Do an Autotest	43
“Bad Patch Cord” Message	49
How to Certify Patch Cords	50
Twisted Pair Autotest Results	50
Automatic Diagnostics	51
PASS*/FAIL* Results	53
WIRE MAP Tab	54
PERFORMANCE Tab	56
Frequency-Domain Results	57
How to Save Frequency-Domain Results as a Plot or a Table	57
DIAGNOSTIC and FAULT INFO Tabs	62
Continuous Tests	62
Long-Range Communication Mode (DSX-5000)	63
About the AxTalk Analyzer Kit	63

Chapter 3	Certify Coaxial Cabling	
	Set the Reference for Coaxial Tests	65
	Settings for Coaxial Tests	67
	How to Do an Autotest	69
	Coaxial Autotest Results	72
	About Splitters	73
	Tests Without a Remote	74
	Continuous Tests	77
Chapter 4	Clean Fiber Endfaces	
	Always Clean Endfaces Before Tests	79
	How to Use a Fluke Networks Quick Clean Cleaner	82
	How to Use Wipes, Swabs, and Solvent	84
	To Clean Bulkhead Connectors	84
	To Clean the Optical Connectors on the Modules	85
	To Clean Fiber Adapters	85
	To Clean Connector Ends	85
Chapter 5	Inspect Fiber Endfaces	
	Connectors, Keys, and LEDs	88
	Settings for FiberInspector Tests	90
	How to Do the FiberInspector Test	91
	Automatic Analysis of Scratches and Defects	96
	Fiber Tests with Two Main Testers	98
Chapter 6	Certify Fiber Cabling	
	Overview of Features	99
	Connectors, Keys, and LEDs	100

How to Remove and Install the Connector Adapters	105
The CertiFiber Pro Home Screen	106
Requirements for Reliable Fiber Test Results	109
About the Reference for Fiber Tests	110
When to Set the Reference	110
Good Reference Values	111
How to See the Reference Values	111
About Test Reference Cords and Mandrels	112
About the EF-TRC (Encircled-Flux Test Reference Cords)	112
About APC Connectors	114
About Standard Mandrels	116
Settings for Fiber Tests	116
About 1 Jumper Reference Connections	123
Autotest in Smart Remote Mode	124
Fiber Tests with Two Main Testers	124
Step 1: Set the Reference in Smart Remote Mode	126
Step 2: Measure the Loss of the Test Reference Cord You Will Add	128
Step 3: Do an Autotest in Smart Remote Mode	129
Autotest Results for Smart Remote Mode	130
Fiber IDs for Saved Results in Smart Remote Mode	132
Autotest in Loopback Mode	132
Step 1: Set the Reference in Loopback Mode	134
Step 2: Measure the Loss of the Test Reference Cord You Will Add	136
Step 3: Do an Autotest in Loopback Mode	137

Autotest Results for Loopback Mode	138
Autotest in Far End Source Mode	140
Auto Wavelength Modes	140
Step 1: Set the Reference in Far End Source Mode	142
Step 2: Measure the Loss of the Test Reference Cord You Will Add	145
Step 3: Do an Autotest in Far End Source Mode	146
Autotest Results for Far End Source Mode	147
Bi-directional Tests	149

Chapter 7 Use the OTDR

Overview of Features	153
Connectors, Keys, and LEDs	154
How to Remove and Install the Connector Adapters	157
The OptiFiber Pro Home Screen	158
Settings for OTDR Tests	160
About Launch and Tail Cords	165
How to Set Up the Launch Compensation Function	166
How to Prevent Damage to the Launch Cord Connectors	167
How to Hang the Launch Cords	168
OTDR Port Connection Quality	169
If the Gauge is Not in the Good Range	169
Port Connection Quality for SmartLoop Tests	169
"STOP" Button for Manual Tests	170
How to Do an OTDR Test	171
OTDR Results	175

EventMap	175
Event Table	180
OTDR Trace	182
How to Quickly Change OTDR Settings After a Test	184
The FaultMap Test	186
How to Do the FaultMap Test	187
FaultMap Screen	190
The SmartLoop Test	192
How To Do an Auto SmartLoop Test	194
Set up the launch compensation function	194
Do the SmartLoop test	196
SmartLoop Results	198
Bi-directional SmartLoop Tests	199
How to Do a Bi-directional SmartLoop Test	199
Set up the launch compensation function	199
Do the SmartLoop test	201
Averaged Bi-directional Results	203

Chapter 8 Use the HDR OTDR

Overview of Features	207
Connectors, Keys, and LEDs	208
How to Remove and Install the Connector Adapters	211
The OptiFiber Pro HDR OTDRHome Screen	212
About PON OTDR Tests	214
Settings for HDR OTDR Tests	215
About Launch and Tail Cords for OSP Links	220
OTDR Port Connection Quality	222
If the Gauge is Not in the Good Range	222

Port Connection Quality for SmartLoop Tests	222
“STOP” Button for Manual Tests	223
How to Do an HDR OTDR Test	224
HDR OTDR Results	228
EventMap	228
Event Table	232
HDR OTDR Trace	234
How to Quickly Change OTDR Settings After a Test	236
The FaultMap Test	238
How to Do the FaultMap Test	239
FaultMap Screen	242
The SmartLoop Test	244
How To Do an Auto SmartLoop Test	246
Set up the launch compensation function	246
Do the SmartLoop test	248
SmartLoop Results	250
Bi-directional SmartLoop Tests	251
How to Do a Bi-directional SmartLoop Test	252
Set up the launch compensation function	252
Do the SmartLoop test	253
Averaged Bi-directional Results	255

Chapter 9 Use the OTDR Span and Event Editing Functions

Overview of Features	259
How to Edit a Loss Event	259
PASS/FAIL Result for Edited Events	260
Editing Events in Bi-directional Results	262
Other Options for Editing Events	262
How to Use the Span Function	263

When the Tester Will Not Use Your Span Settings	263
How to Define a Span	264
How to Do a Test with Your Span Settings	264
Bi-directional Tests with Span Settings	264
How to Remove the Span Definition	268
How to Remove the Span Definition from a Test Result	268

Chapter 10 Use the Visual Fault Locator

Visual Fault Locator Applications	269
How to Use the VFL	270

Chapter 11 Monitor Optical Power

How to Control the Light Source	277
Use the Display to Control the Main Tester's Light Source	278
Use the Module's Button to Control the Light Source	278

Chapter 12 Manage Test Results

View Saved Results	281
How to Add a Result to a Saved Result	285
How to Replace a Saved Result that Failed	286
Delete, Rename, and Move Results	286
Manage Results on a Flash Drive	288
Upload Results to a PC	289
Memory Capacity	290
View the Memory Status	291

Chapter 13 Use Projects

Why Use Projects?	293
Set Up a Project	294
The PROJECT Screen	294
About Project Names from LinkWare Live	297
The CABLE ID SETUP Screen	297
About Next ID Sets	297
Manage Projects on a Flash Drive	300
Copy Project Settings to Other Testers	301
The LinkWare Live Web Application	301

Chapter 14 Sync Projects with LinkWare™ Live

Sign Up for a LinkWare Live Account	303
How to See the Tester's MAC Address	304
Use LinkWare Live Through a Wired Ethernet Network	304
Use LinkWare Live Through a Wi-Fi Network	305
When You Cannot Sync a Deleted Project	308
About the Asset Management Service	309
Change the Network Settings	309
Settings for the Wired Port	310
Settings for Wi-Fi	310
Regulatory Information for the Wi-Fi Radio	310
Delete Wi-Fi Settings and Passwords	310
Sign Your Tester Out of LinkWare Live	310
Sign In to LinkWare Live from a Desktop or Mobile Device	312
Import Projects from LinkWare Live into LinkWare PC	312
Learn More About LinkWare Live	312

Chapter 15 Maintenance

Verify Operation	313
Clean the Tester	314
Clean the FI-1000 Video Probe	314
See Information About the Tester	315
Traceable Calibration Period	315
Update the Software	315
About Versiv and Versiv 2 Update Files	316
Use a PC to Update the Software	316
Use an Updated Main Tester to Update Other Testers	318
Use LinkWare Live to Update the Software	320
Update the Software in a Module	320
Extend the Life of the Battery	321
Store the Tester	321
Remove the Battery	322
If the Tester Does Not Operate as Usual	322
Before You Send a Main Tester to a Service Center	323
Options and Accessories	324

Appendix A: Reference Method Names

Appendix B: Modified 1 Jumper Reference Method

List of Figures

Figure		Page
1.	LEDs Show the Remote's Battery Status	14
2.	Connections to See the Status of a Remote's Battery...	16
3.	How to Zoom the Screen	18
4.	FIX LATER, TEST AGAIN, and TEST Buttons and the TEST Key	19
5.	How to Install a Strap and Use the Hand Strap.....	22
6.	How to Remove and Install a Module	23
7.	Main Tester Connectors, Keys, and LEDs (Versiv 2 shown)	26
8.	Remote Tester Connectors, Keys, and LEDs (Versiv 2 shown)	28
9.	How to Attach and Remove Link Interface Adapters ...	30
10.	How to Prevent Damage to the Permanent Link Adapter Cables.....	31
11.	DSX-8000 and DSX-5000 Module and Adapter Differences.....	32
12.	The Home Screen for the DSX CableAnalyzer	33
13.	Reference Connections for Twisted Pair Cable	37
14.	Outlet Configurations - RJ45	42
15.	Outlet Configurations - Industrial Ethernet	43
16.	Equipment for Autotests on Twisted Pair Cable	44
17.	Permanent Link Connections for Links Up to Cat 7 _A	46
18.	Channel Connections for Links Up to Cat 7 _A	47
19.	Permanent Link Connections for Cat 8/Class I/II Links...	48
20.	Channel Connections for Cat 8/Class I/II Links	48

21.	Connections for Modular Plug Terminated Links (MPTL).....	49
22.	Examples of Fault Information Screens.....	52
23.	PASS* and FAIL* Results.....	53
24.	WIRE MAP Tab.....	54
25.	PERFORMANCE Tab.....	56
26.	Tabular Results Screen for a Frequency-Domain Test ...	58
27.	Plot Screen for a Frequency-Domain Test.....	60
28.	Reference Connections for Tests on Coaxial Cabling	66
29.	Equipment for Tests on Coaxial Cabling.....	69
30.	Examples of Connections for Tests on Coaxial Cabling.	71
31.	Autotest Results for Coaxial Cabling.....	72
32.	Connections for Coaxial Tests Without a Remote	76
33.	Examples of Clean and Dirty Fiber Endfaces.....	79
34.	Equipment to Clean and Inspect Fiber Endfaces	81
35.	How to Use the One Click Cleaner	83
36.	Connectors, Keys, and LEDs (Versiv 2 shown)	88
37.	Equipment for the FiberInspector Test	91
38.	How to Use the FI-1000 Probe	93
39.	How to Use the Optional MPO/MTP® Inspection Tip.....	93
40.	FiberInspector Image with Manual Grading Selected...	94
41.	FiberInspector Image with Defect Analysis.....	97
42.	Main Tester Connectors, Keys, and LEDs (Versiv 2 with CFP-QUAD module shown).....	100
43.	Remote Tester Connectors, Keys, and LEDs (Versiv 2 with CFP-QUAD module shown).....	103
44.	How to Remove and Install the Connector Adapters....	105
45.	The Home Screen for CertiFiber Pro Modules.....	106
46.	How to Prevent Damage to the EF-TRC Fiber Cables	113
47.	TRCs Necessary for Links with APC Connectors.....	115

48.	Screen to Set the Number of Connectors, Splices, and Jumpers	120
49.	How to Count the Numbers of Connectors, Splices, and Jumpers	122
50.	Equipment for Autotests in Smart Remote Mode	125
51.	Connections for Smart Remote Mode (1 Jumper Reference, Multimode Fiber)	127
52.	Result for Smart Remote Mode (Unsaved Bi-Directional Results Shown)	131
53.	Equipment for Autotests in Loopback Mode	133
54.	Connections for Loopback Mode (1 Jumper Reference, Multimode Fiber)	135
55.	Result for Loopback Mode	138
56.	Equipment for Autotests in Far End Source Mode	141
57.	Connections for Far End Source Mode (1 Jumper Reference Multimode Fiber)	144
58.	How to Turn on the Remote's Optical Source	145
59.	Result for Far End Source Mode	148
60.	Connections for a Bi-directional Test in Smart Remote Mode (1 Jumper Reference, Multimode Fiber)	152
61.	Connectors, Keys, and LEDs (Versiv 2 with OptiFiber Pro Quad OTDR shown)	155
62.	How to Remove and Install the Connector Adapters ...	157
63.	The Home Screen for OptiFiber Pro Modules.....	158
64.	How to Prevent Damage to the Launch Cord Connectors.....	167
65.	How to Use the Optional TPAK Magnetic Hanger.....	168
66.	The OTDR Port Connection Quality Gauge and Progress Screen	170
67.	Equipment for OTDR Tests	171
68.	OTDR Connected with a Launch Cord	172
69.	OTDR Connected with Launch and Tail Cords.....	173

70.	OTDR Connected to a Spool of Fiber.....	174
71.	EventMap Example 1	176
72.	EventMap Example 2	179
73.	Event Table	181
74.	OTDR Trace	183
75.	Manual OTDR Screen for Quick Changes After a Test ..	185
76.	Equipment for FaultMap Tests	188
77.	FaultMap Test Connections.....	189
78.	FaultMap Screen	190
79.	Equipment for SmartLoop Tests	193
80.	SmartLoop Launch Compensation Connections	195
81.	SmartLoop Test Connections	197
82.	EventMap from a SmartLoop Test.....	198
83.	SmartLoop Test Connections for a Bi-Directional Test..	202
84.	EventMap for Averaged, Bi-directional SmartLoop Results	204
85.	Connectors, Keys, and LEDs (Versiv 2 with OFP-200-S1625 OTDR module shown)....	209
86.	How to Remove and Install the Connector Adapters....	211
87.	The Home Screen for OptiFiber Pro HDR Modules.....	212
88.	The OTDR Port Connection Quality Gauge and Progress Screen.....	223
89.	Equipment for HDR OTDR Tests	225
90.	Typical Connections to an Out-of-Service PON Link.....	226
91.	HDR OTDR Connected with Launch and Tail Cords.....	227
92.	EventMap for an HDR OTDR Test Result	229
93.	Event Table from an HDR OTDR Test	233
94.	HDR OTDR Trace	235
95.	Manual PON OTDR Screen for Quick Changes After a Test	237

96.	Equipment for FaultMap Tests	240
97.	FaultMap Test Connections	241
98.	FaultMap Screen.....	242
99.	Equipment for SmartLoop Tests.....	245
100.	SmartLoop Launch Compensation Connections.....	247
101.	SmartLoop Test Connections	249
102.	EventMap from a SmartLoop Test	250
103.	SmartLoop Test Connections for a Bi-Directional Test .	254
104.	EventMap for Averaged, Bi-directional SmartLoop Results.....	256
105.	How to Edit a Loss Event	261
106.	EventMap for a Span	265
107.	Event Table for a Span.....	266
108.	OTDR Trace for a Span.....	267
109.	Equipment for Visual Fault Locator Tests	270
110.	How to Use the Visual Fault Locator.....	272
111.	Equipment for Power Meter Measurements.....	274
112.	Connections to Monitor Power and Loss.....	275
113.	Power Meter Measurements and Controls.....	276
114.	Light Source Controls for the Main Tester	279
115.	RESULTS Screen	282
116.	How to Connect the Tester to a PC.....	290
117.	PROJECT Screen	295
118.	CABLE ID SETUP Screen (after you enter the first and last IDs)	298
119.	SYNC PROJECTS Screen	307
120.	How to Connect the Tester to a PC.....	317
121.	How to Connect Units Together to Update the Software	319
122.	How to Remove the Battery.....	322

B-1. Modified 1 Jumper Reference Method for Smart Remote Mode328

Chapter 1: Get Acquainted

Overview of Features

The Versiv and Versiv™ 2 main and remote testers are rugged, hand-held instruments that you configure to certify, troubleshoot, and document copper and fiber optic cabling. The Versiv platform includes these features:

Note

Feature descriptions in the Versiv Series documentation apply to Versiv and Versiv 2 testers unless stated otherwise.

- Operates with DSX CableAnalyzer™ modules to certify twisted pair cabling. See Chapter 2.
- Operates with CertiFiber® Pro Optical Loss Test Set (OLTS) modules to measure optical power loss and length on dual-fiber, multimode and singlemode cabling. See Chapter 6.
- Operates with OptiFiber® Pro OTDR modules to locate, identify, and measure reflective and loss events in multimode and singlemode fibers. See Chapter 7.
- Operates with OptiFiber Pro HDR modules to do tests on OSP (Outside Plant) installations that include optical splitters. See Chapter 8.
- The optional FI-1000 FiberInspector™ video probe connects to the type A USB port on the main tester to let you inspect the endfaces in fiber optic connectors. See Chapter 5.
- Gives a PASS or FAIL result based on a test limit that you specify.
- Taptive™ user interface lets you quickly navigate through different views of the results and see more information about cables.

- ProjX™ management system lets you set up projects to specify the types of tests and the cable IDs necessary for a job and monitor the progress and status of the job.
- You can connect the tester to a wired or Wi-Fi network and use the LinkWare™ Live web application to manage your projects from a desktop or mobile device.
- LinkWare PC software lets you upload test results to a PC and make professional-quality test reports.
- LinkWare Stats software makes browsable, graphical reports of cable test statistics.

Versiv 2 Compatibility

Versiv 2 testers are not compatible with Versiv testers.

Versiv 2 mainframes do not support the OptiView XG Performance Test Remote or the OneTouch AT Network Assistant modules.

Contact Fluke Networks



www.flukenetworks.com/support



info@flukenetworks.com



1-800-283-5853, +1-425-446-5500



Fluke Networks
6920 Seaway Boulevard, MS 143F
Everett WA 98203 USA

Fluke Networks operates in more than 50 countries worldwide.
For more contact information, go to our website.

Register Your Product

Registering your product with Fluke Networks gives you access to valuable information on product updates, troubleshooting tips, and other support services. If you purchased a Gold Support plan, registration also activates your plan.

To register your product, use LinkWare PC software.

Technical Reference Handbook

The *Versiv Series Technical Reference Handbook* has more information about the tester. The Handbook is available on the Fluke Networks website.

Additional Resources

The Fluke Networks Knowledge Base answers common questions about Fluke Networks products and provides articles on cable testing techniques and technology.

To access the Knowledge Base, log on to www.flukenetworks.com, then click **SUPPORT > Knowledge Base**.

Supplements and Updated Manuals

If necessary, Fluke Networks will put a supplement for this manual, or an updated manual, on the Fluke Networks website. To see if a supplement or updated manual is available, log on to www.flukenetworks.com, click **SUPPORT > Manuals**, then select a product.

Kit Contents

For a list of the contents of your Versiv or Versiv 2 kit, see the list that came in the product's box or see the lists of models and accessories on the Fluke Networks website. If something is damaged or missing, contact the place of purchase immediately.

Symbols

Table 1 shows the symbols used on the tester or in this manual.

Table 1. Symbols









	Warning: Risk of fire, electric shock, or personal injury.
	Warning or Caution: Risk of damage or destruction to equipment or software. See explanations in the manuals.
	Warning: Class 1 (OUTPUT port) and Class 2 (VFL port) lasers. Risk of eye damage from hazardous radiation.
	Consult the user documentation.
	40 year Environment Friendly Use Period (EFUP) under China Regulation - Administrative Measure on the Control of Pollution Caused by Electronic Information Products. This is the period of time before any of the identified hazardous substances are likely to leak out, causing possible harm to health and the environment.
	Conforms to the Appliance Efficiency Regulation (California Code of Regulations, Title 20, Sections 1601 through 1608), for small battery charging systems.
	This product complies with the WEEE Directive marking requirements. The affixed label indicates that you must not discard this electrical/electronic product in domestic household waste. Product Category: With reference to the equipment types in the WEEE Directive Annex I, this product is classed as category 9 "Monitoring and Control Instrumentation" product. Do not dispose of this product as unsorted municipal waste. To return unwanted products, contact the manufacturer's web site shown on the product or your local sales office or distributor.
	This Product contains a lithium-ion battery. Do not mix with the solid waste stream. Spent batteries should be disposed of by a qualified recycler or hazardous materials handler per local regulations. Contact your authorized Fluke Service Center for recycling information.
	Conformite Europeene. Conforms to requirements of European Union directives. Safety requirements for electrical equipment for measurement, control, and laboratory use.

Table 1. Symbols (continued)

	Conforms to relevant North American standards.
	Conforms to relevant Australian standards.
	Conforms to relevant Russian standards.
	EMC approval for Korea. Class A Equipment (Industrial Broadcasting & Communication Equipment). This product meets requirements for industrial (Class A) electromagnetic wave equipment and the seller or user should take notice of it. This equipment is intended for use in business environments and is not to be used in homes.
	This key turns the tester on and off.

Safety Information

For the Main and Remote Units

Warning

To prevent possible fire, electric shock, or personal injury:

- Read all safety information before you use the Product.
- Carefully read all instructions.
- Do not open the case. You cannot repair or replace parts in the case.
- Do not modify the Product.
- Use only replacement parts that are approved by Fluke Networks.

- Do not touch voltages > 30 V AC rms, 42 V AC peak, or 60 V DC.
- Do not use the Product around explosive gas, vapor, or in damp or wet environments.
- Charge the battery indoors.
- Use the Product only as specified, or the protection supplied by the Product can be compromised.
- Do not use and disable the Product if it is damaged.
- Do not use the Product if it operates incorrectly.
- Batteries contain hazardous chemicals that can cause burns or explode. If exposure to chemicals occurs, clean with water and get medical aid.
- Remove the batteries if the Product is not used for an extended period of time, or if stored in temperatures above 50 °C. If the batteries are not removed, battery leakage can damage the Product.
- Replace the rechargeable battery after 5 years of moderate use or 2 years of heavy use. Moderate use is defined as recharged twice a week. Heavy use is defined as discharged to cutoff and recharged daily.
- Disconnect the battery charger and move the Product or battery to a cool, non-flammable location if the rechargeable battery becomes hot (>50 °C, >122 °F) during the charge period. The battery door must be closed and locked before you operate the Product.
- The battery door must be closed and locked before you operate the Product.
- Repair the Product before use if the battery leaks.
- Recharge the batteries when the low battery indicator shows to prevent incorrect measurements.

- Turn off the Product and disconnect all test leads, patch cords, and cables before you replace the battery.
- Do not disassemble or crush battery cells and battery packs.
- Do not put battery cells and battery packs near heat or fire. Do not put in direct sunlight.
- Have an approved technician repair the Product.
- Use only AC adapters approved by Fluke Networks for use with the Product to supply power to the Product and charge the battery.

 **Caution**

To prevent damage to the tester or cables under test and to prevent data loss:

- Keep modules attached to the testers to give protection to the module connectors.
- Do not remove the USB flash drive while the LED on the drive flashes. Doing so can corrupt the data on the drive.
- You can lose a USB flash drive, cause damage to it, or accidentally erase the contents of the drive. Thus, Fluke Networks recommends that you save no more than one day of test results on a flash drive, or that you upload results to LinkWare Live. See Chapter 14.

For DSX Modules

Warning

To prevent possible fire, electric shock, or personal injury:

- Do not connect the tester to telephony inputs, systems, or equipment, including ISDN inputs. Doing so is a misapplication of this product, which can cause damage to the tester and make a possible shock hazard for the user.
- Always turn on the tester before you connect it to a link. Doing so activates the tester's input protection circuitry.
- Do not operate the Product with covers removed or the case open. Hazardous voltage exposure is possible.
- Remove the input signals before you clean the Product.
- Do not put metal objects into connectors.

Caution

To prevent damage to the tester or cables under test, to prevent data loss, and to make sure your test results are as accurate as possible:

- Do not connect the tester to an active network. Doing so causes unreliable test results, can disrupt network operations, and can cause damage to the tester.
- Connect to the adapters only plugs that are made for Ethernet applications, such as RJ45, ARJ45, and Cat 7 plugs. Other types of plugs, such as RJ11 (telephone) plugs, can cause permanent damage to the jacks.

- To make sure your test results are as accurate as possible, do the reference procedure every 30 days. See “Set the Reference” on page 36.
- Do not operate portable transmitting devices, such as walkie-talkies and cell phones, during a cable test. Doing so can cause errors in test results.
- For permanent link adapters, do not twist, pull on, pinch, crush, or make kinks in the cables. See Figure 10 on page 31.

For CertiFiber Pro OLTS Modules

Warning: Class 1 and Class 2 Laser Products

To prevent possible eye damage caused by hazardous radiation:

- Do not look directly into optical connectors. Some optical equipment emits invisible radiation that can cause permanent damage to your eyes.
- Keep the module’s OUTPUT ports covered with a dust cap or keep a test reference cord attached. The OUTPUT ports can emit radiation even when you do not do a test.
- When you inspect fiber endfaces, use only magnification devices that have the correct filters.
- Use the Product only as specified or hazardous laser radiation exposure can occur.

Caution

To prevent damage to the tester or cables under test and to prevent data loss:

- Do not connect the tester to an active network. Doing so causes unreliable test results, can disrupt

network operations, and can cause damage to the module's receiver.

- Use proper cleaning procedures to clean all fiber connectors before every use. Neglecting this step or using improper procedures can cause unreliable test results and may permanently damage the connectors. See Chapter 4.
- Use a video probe to periodically inspect the module's optical connectors for scratches and other damage.
- Do not connect APC (angled physical contact) connectors to the output ports. Doing so can damage the port's UPC endface and cause unreliable test results.
- To make sure your test results are as accurate as possible, do the reference procedure frequently. See "About the Reference for Fiber Tests" on page 110.
- Use only high-quality test reference cords that comply with the standards. See "About Test Reference Cords and Mandrels" on page 112

For OptiFiber Pro OTDR Modules

 **Warning: Class 1 and Class 2 Laser Products** 

To prevent possible eye damage caused by hazardous radiation:

- Do not look directly into optical connectors. Some optical equipment emits invisible radiation that can cause permanent damage to your eyes.
- Do not do any tests that activate the outputs on the tester unless a fiber is attached to the output.
- When you inspect fiber endfaces, use only magnification devices that have the correct filters.

- Use of controls, adjustments, or procedures not stated herein can possibly result in hazardous radiation exposure.

Caution

To prevent damage to the tester or cables under test:

- Do not connect the OTDR port to an optical source. Doing so can cause damage to the OTDR receiver.
- Do not connect the tester to an active network. Doing so causes unreliable test results, can disrupt network operations, and can cause damage to the OTDR receiver.
- Do not touch reflective surfaces (such as metal) to the end of a fiber cable connected to the OTDR when the OTDR is operating. An open fiber connector endface has about a 4% reflection. Holding a reflective surface near the connector endface can cause more than a 4% reflection, which can damage the photodetector in the OTDR.
- Do not connect APC (angled physical contact) connectors to the OptiFiber Pro OTDR ports. Do not connect PC or UPC connectors to the OptiFiber Pro HDR OTDR ports. Doing so can damage the port's endface, and the large reflection at the OTDR port can cause unreliable test results.
- Use proper cleaning procedures to clean all fiber connectors before every use. Neglecting this step or using improper procedures can cause unreliable test results and may permanently damage the connectors. See Chapter 4.
- Use a video probe to periodically inspect the OTDR connectors for scratches and other damage.
- Read the instructions for splice machines before using the OTDR to monitor splicing procedures. The OTDR can interfere with the light injection detection techniques used by some splicers.

AC Adapter and Battery

You can use the AC adapter (model PWR-SPLY-30W) or the lithium ion battery (model VERSIV-BATTERY) to supply power to the tester.

To remove the battery, see “Remove the Battery” on page 322.

Charge the Battery

Before you use the battery for the first time, charge it for about 2 hours with the tester turned off.

To charge the battery

Connect the AC adapter to the 15V jack on the left side of the tester.

Versiv 2: The LED in the power button shows the status of the battery charging process. See Table 2.

Versiv: The LED near the AC adapter connector is red when the battery charges, and green when the battery is fully charged. The LED is yellow if the battery will not charge.

A fully-charged battery operates for approximately 8 hours of typical use. The battery takes approximately 4 hours to fully charge when the tester is turned off.









Notes

You do not need to fully discharge the battery before you recharge it.

The battery will not charge if its temperature is outside the range of 32 °F to 104 °F (0 °C to 40 °C).

The LED is yellow if the battery will not charge.

Table 2. Power Button's LED Indications for Versiv 2 Testers

 	<p>Green, steady: The tester is on and the AC adapter is not connected, or the AC adapter is connected and the battery is fully charged.</p> <p>Green, flashing: The tester is off, the AC adapter is connected, and the battery is fully charged.</p>
 	<p>Red, steady: The tester is on and the battery is charging. The LED stays red for a few minutes after the battery status icons show that the battery is fully charged.</p> <p>Red, flashing: The tester is off and the battery is charging.</p>
 	<p>Red steady or alternating red/green: The AC adapter is connected, but the battery is not installed.</p>
 	<p>Yellow, steady: The tester is on and the AC adapter is connected, but there is an issue with the battery:</p> <ul style="list-style-type: none"> • The battery voltage is very low. The AC adapter will trickle-charge the battery until the voltage increases, then charge the battery at the normal rate. • The battery will not charge because its temperature is outside the range of 32 °F to 104 °F (0 °C to 40 °C). <p>Yellow, flashing: Same as above, but the tester is off.</p>
 <p>x5</p>	<p>Yellow, flashes 5 times: This occurs when the tester reboots after a software update, or if tester reboots because it had an unrecoverable error.</p>

Check the Battery Status

On a main tester

The battery status icon is in the upper-left corner of the screen:



Battery is full. The LED stays red for a few minutes after the battery status icons show that the battery is fully charged.



Battery is approximately half full.



If the AC adapter is not connected, the red bar shows that the battery is low. Connect the AC adapter to charge the battery and make sure the tester continues to operate.

The red bar also shows if the AC adapter is connected, but the battery is not installed.

On a remote

The LEDs show the battery status at the end of the power-up sequence, as shown in Figure 1.

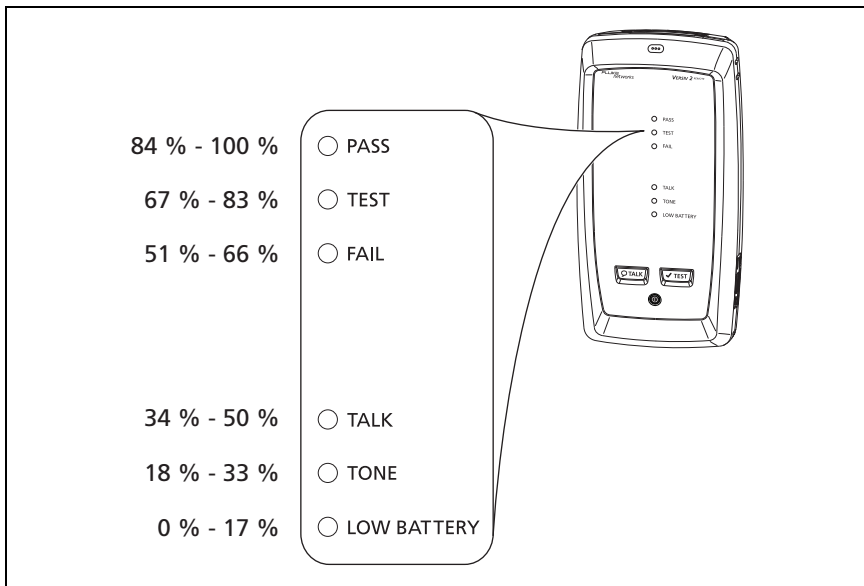



Figure 1. LEDs Show the Remote's Battery Status

GPU102.EPS

To see more information about a remote's battery status

- 1 Make the connections shown in Figure 2 and turn on both testers.
- 2 For CertiFiber Pro testers, select **Smart Remote** or **Loopback** mode.
- 3 Make sure the connection icon shows at the top of the screen ().
- 4 Tap **TOOLS**, then tap **Battery Status**.

When the AC adapter is not connected, the screen shows the **Time Remaining**, which is the approximate battery life at the present rate of use.

Verify Operation

The tester does a self test when you turn it on. If the tester shows an error or does not turn on, refer to "If the Tester Does Not Operate as Usual" on page 322.

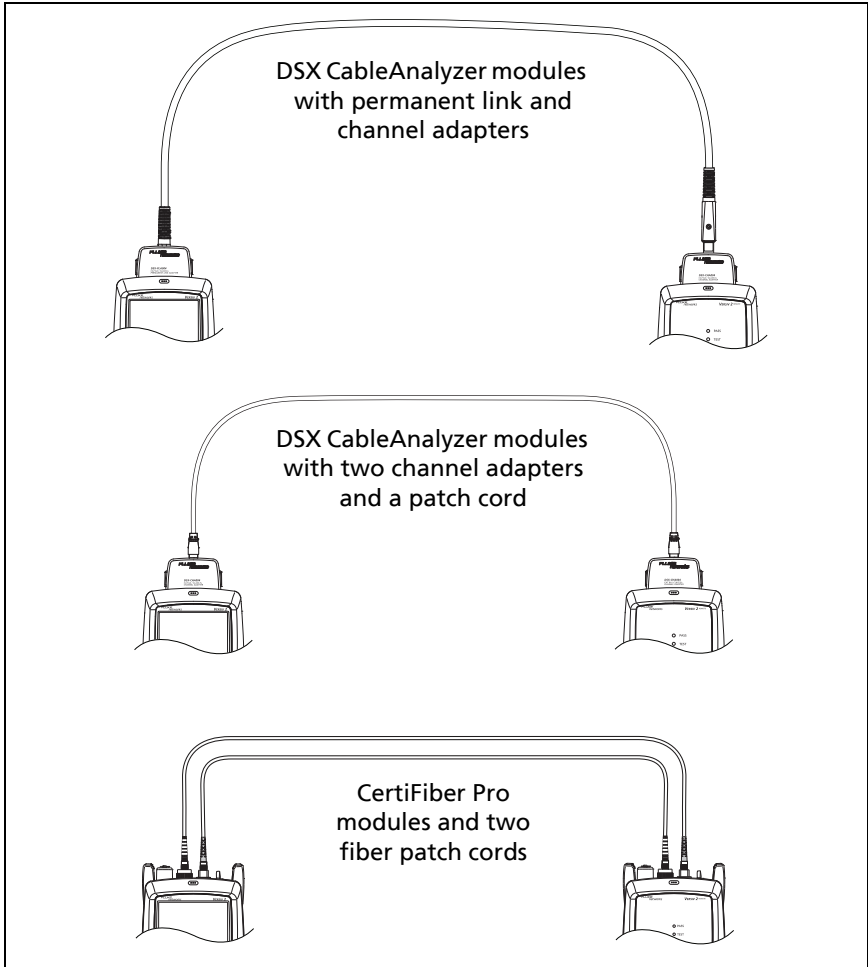

Figure 2. Connections to See the Status of a Remote's Battery

How to Use the Touchscreen

The main tester's Taptive™ user interface lets you use a touchscreen to control the tester. You can operate the touchscreen with your fingertip or with a stylus that is made for projected capacitance touchscreens.

Caution

For correct operation and to prevent damage to the touchscreen:

- **Touch the screen only with your fingers or with a stylus that is made for projected capacitance touchscreens. Do not use too much force.**
- **Do not touch the screen with sharp objects.**

Note

The touchscreen will not respond if you tap it with your fingernail or an incorrect type of stylus or if you wear non-conductive gloves.

To use the touchscreen

- To select an item on the screen, tap the item lightly with your fingertip.
- To scroll a screen, lightly touch the screen then move your fingertip in the direction you want the screen to move.
- On screens that show a plot, trace, or FiberInspector image, you can drag some items, such as the measurement cursor on a plot or trace or the image on a FiberInspector screen. These screens also have a zoom function, as shown in Figure 3.

To clean the touchscreen

Turn off the tester, then use a soft, lint-free cloth that is moist with a mild detergent.

Caution

When you clean the touchscreen, do not let liquid get under the plastic around the touchscreen.

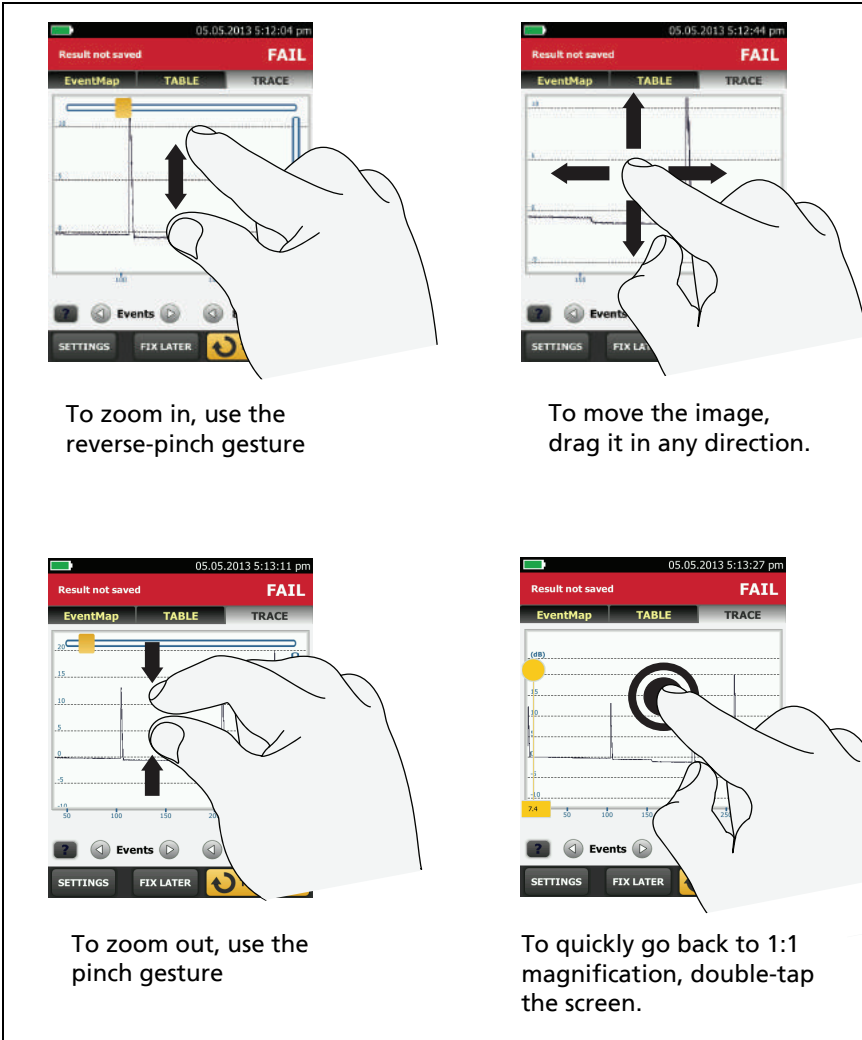

To zoom in, use the reverse-pinch gesture

To move the image, drag it in any direction.

To zoom out, use the pinch gesture

To quickly go back to 1:1 magnification, double-tap the screen.

GPU45.EPS

Figure 3. How to Zoom the Screen

Change the Language

On the home screen, tap the **TOOLS** icon, tap **Language**, then tap a language.

Buttons to Do Tests and Save Results

When a test is completed and more than one button shows at the bottom of the screen, the tester highlights one in yellow to recommend which one to tap. Figure 4 shows the buttons you will see.

Note

To change the **Auto Save** setting, tap the **Next ID** panel on the home screen.

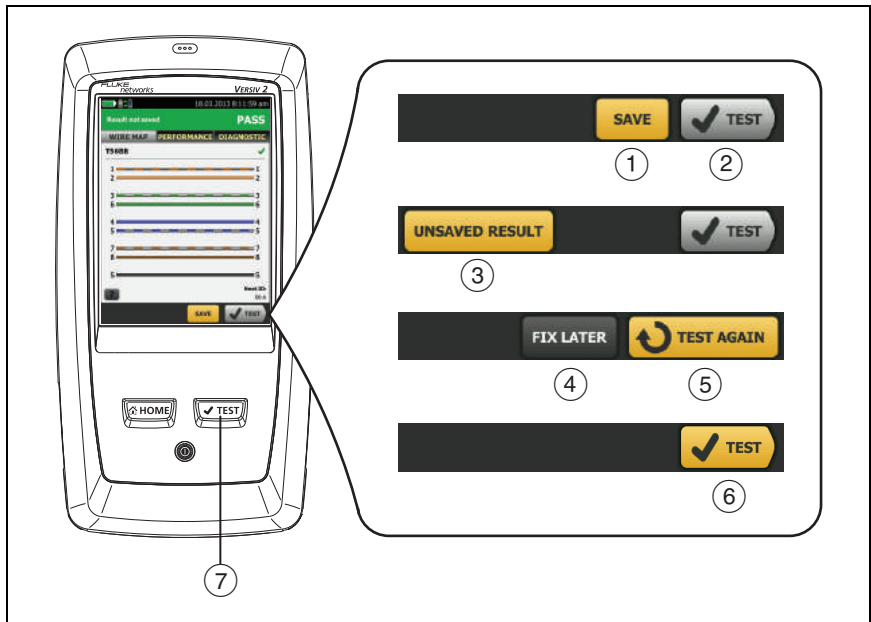

Figure 4. FIX LATER, TEST AGAIN, and TEST Buttons and the TEST Key

GPU40.EPS

- ① **SAVE** (yellow), ② **TEST** (gray): These buttons show if the test passed and **Auto Save** is off. When you tap **SAVE**, you can save the results with an ID that you make or select. When you tap **TEST**, you can select to save the results or do the test again and not save the results.
- ③ **UNSAVED RESULT**: This button shows if **Auto Save** is off and you go to the home screen when a test is completed. Tap this button to see the result.
- ④ **FIX LATER**: This button shows if the test failed or had a **PASS*** result and the result has not been saved.
- ⑤ **TEST AGAIN**: This button shows if the test failed or had a **PASS*** result. Tap this button to do the test again. If **Auto Save** is on, the tester saves subsequent results with the same ID. If the test fails again, you can tap **FIX LATER** to save the result if necessary.

When you look at a saved result that failed, tap **TEST AGAIN** to do the test again for the same ID and with the same test settings as the saved result.

- ⑥ **TEST** (yellow): This button shows if the test passed and **Auto Save** is on. When **Auto Save** is on, the tester saves results with the next available ID when the test is completed. When you tap **TEST**, the tester does a test for the next available ID.
- ⑦ TEST: The TEST key does the same function as the **TEST** button. When **TEST AGAIN** shows, you can press TEST to do a test on the next ID.

Options for Cable IDs

When you save the test results for a cable, you usually give the results the name that is the ID for the cable. There are several methods you can use to make IDs for test results:

- You can use the **CABLE ID SETUP** screen to make a set of sequential IDs. The tester uses the IDs in sequence as the names for the results you save. When **Auto Save** is on, the

tester automatically saves each result with the next available ID in the set.

A cable ID set also lets you use IDs again so you can add different results to tests you saved before.

- You can enter an ID each time you do a test. To do this, turn off the **Auto Save** function (see page 21). Each time a test is completed, tap **SAVE** (if the test passed) or **FIX LATER** (if the test failed), then enter an ID manually.
- You can use LinkWare PC software to make a set of IDs, download the set to the tester, then import it into a project.
- After you do a test, you can enter the ID for a test you saved before. This lets you replace results or add different results to a test you saved before.
- If the test failed before, and you saved the results, you can select it on the **RESULTS** screen, then press **TEST AGAIN** to replace the results for that ID.

Notes

Cable IDs are case-sensitive. For example, the tester saves result with the names "A0" and "a0" in two different records.

A cable ID can have a maximum of 60 characters.

If you delete all the ID sets in a project, the tester makes a default set that starts with 001.

To turn the Auto Save function on or off

- 1 On the home screen, tap the **Next ID** panel.
- 2 On the **CHANGE ID** screen, tap the **On/Off** control next to **Auto Save**.
- 3 Tap **DONE**.

How to Install a Strap

Two types of straps are available for the tester: a hand strap that helps you hold the tester, and an optional carrying strap that lets you carry and hang the tester. Figure 5 shows how to install a strap and how to use the hand strap.

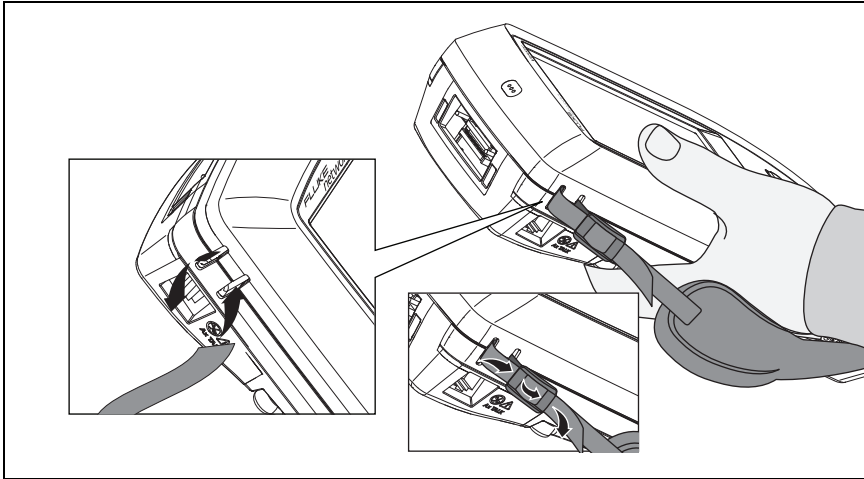

GPU43.EPS

Figure 5. How to Install a Strap and Use the Hand Strap

How to Remove or Install a Module

Figure 6 shows how to remove and install the module.

Note

It is not necessary to turn off the tester before you remove or install a module.

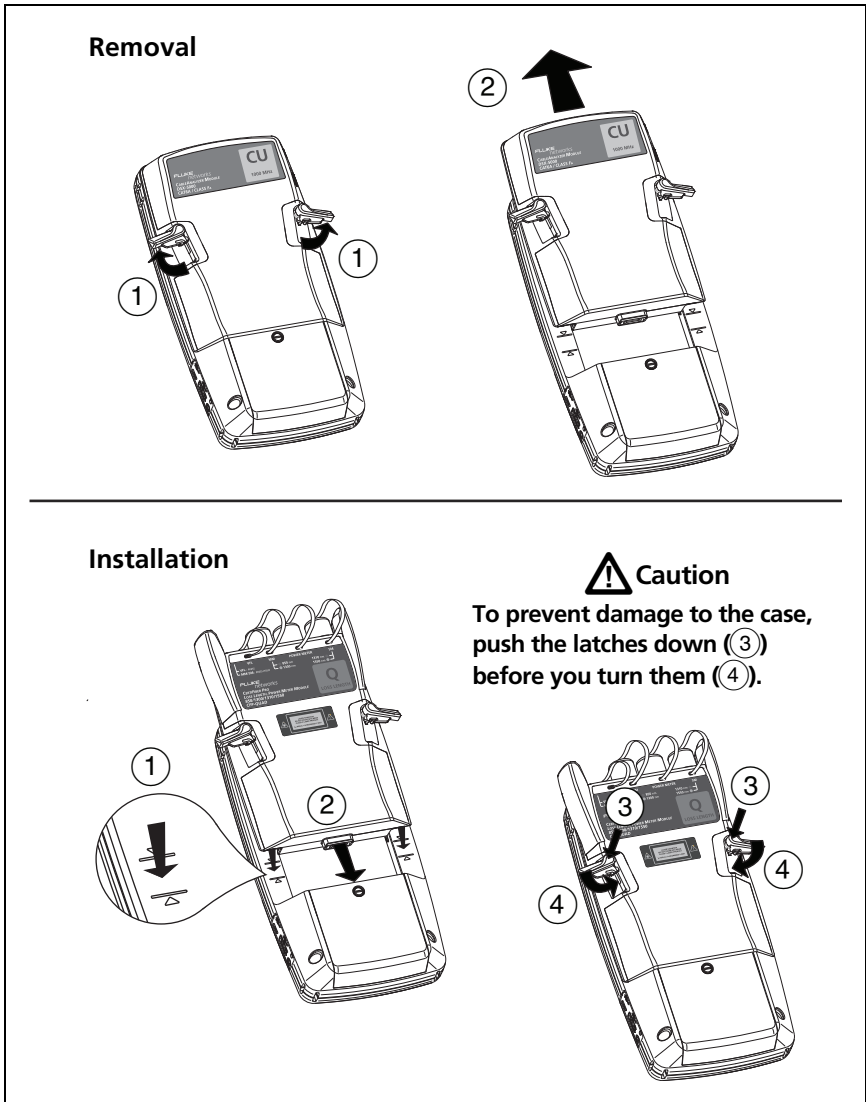

Figure 6. How to Remove and Install a Module

GPU20.EPS

About LinkWare Applications

LinkWare PC Cable Test Management Software

The LinkWare PC Cable Test Management software lets you upload test records to a PC, organize and examine test results, print professional-quality test reports, and do software updates and other maintenance procedures on your tester.

You can download LinkWare PC from the Fluke Networks website.

The LinkWare Live Web Application

The LinkWare Live web application lets you manage your projects from a desktop or mobile device.

To get started with LinkWare Live, see Chapter 14.

LinkWare Stats

The LinkWare Stats Statistical Report software that is included with LinkWare PC software provides statistical analysis of cable test reports and generates browsable, graphical reports.

For instructions about LinkWare PC and LinkWare Stats software, see the guides for getting started and the online help available under **Help** on the LinkWare PC and LinkWare Stats menus.

Chapter 2: Certify Twisted Pair Cabling



Before you use the DSX CableAnalyzer, read the safety information that starts on page 5.

Overview of Features

The Fluke Networks DSX CableAnalyzer™ modules attach to Versiv and Versiv™ 2 main and remote units to make rugged, hand-held testers that let you certify, troubleshoot, and document twisted pair network cabling. The testers includes these features:

- DSX-8000 modules certify twisted pair cabling to Cat 8/Class I/II limits (2000 MHz) in less than 16 seconds.
- DSX-5000 modules certify twisted pair cabling to Cat 7_A/Class F_A limits (1000 MHz) in less than 16 seconds.
- Gives a **PASS** or **FAIL** result based on a test limit that you specify.
- AxTalk software, which is available on the Fluke Networks website, lets you do tests for alien crosstalk.



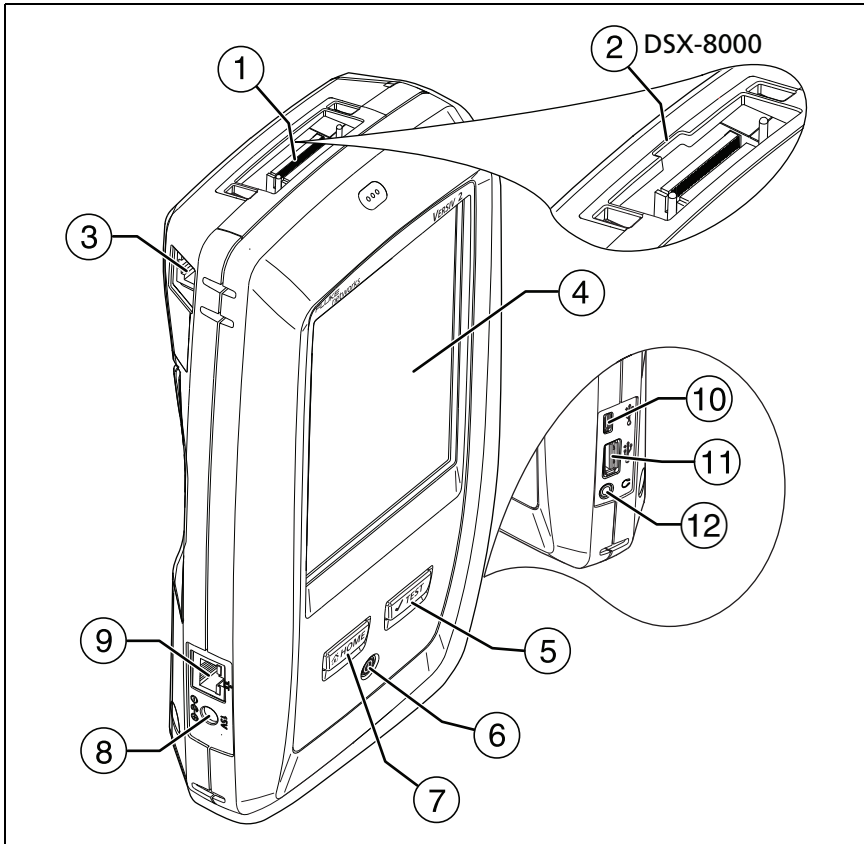

Connectors, Keys, and LEDs



GPU88.EPS

Figure 7. Main Tester Connectors, Keys, and LEDs (Versiv 2 shown)

- ① Connector for a link interface adapter
- ② DSX-8000 modules have a recess for the tabs on Cat 8/Class I/II adapters. You cannot attach Cat 8/Class I/II adapters to DSX-5000 modules.
- ③ RJ45 jack for communications between the main and remote testers when you do alien crosstalk measurements. See “About the AxTalk Analyzer Kit” on page 63.

- ④ LCD display with touchscreen
- ⑤ : Starts a test. Turns on the tone generator if a remote tester is not connected to the main tester. To start a test, you can also tap **TEST** on the display.
- ⑥ : Power button. Versiv 2: The LED in the button shows the status of the battery charging process. See Table 2 on page 13.
- ⑦ : Press  to go to the home screen.
- ⑧ Connector for the AC adapter. Versiv: The LED is red when the battery charges, and green when the battery is fully charged. The LED is yellow if the battery will not charge. See “Charge the Battery” on page 12.
- ⑨ RJ45 connector: Lets you connect to a network for access to Fluke Networks cloud services.
- ⑩ Micro USB port: This USB port lets you connect the tester to a PC so you can upload test results to the PC and install software updates in the tester.
- ⑪ Type A USB port: This USB host port lets you save test results on a USB flash drive and connect the FI-1000 video probe to the tester. On a Versiv main tester, this port lets you or connect a Wi-Fi adapter for access to the Fluke Networks cloud service LinkWare Live. (Versiv 2 testers have an internal Wi-Fi radio.)
- ⑫ Headset jack

Note



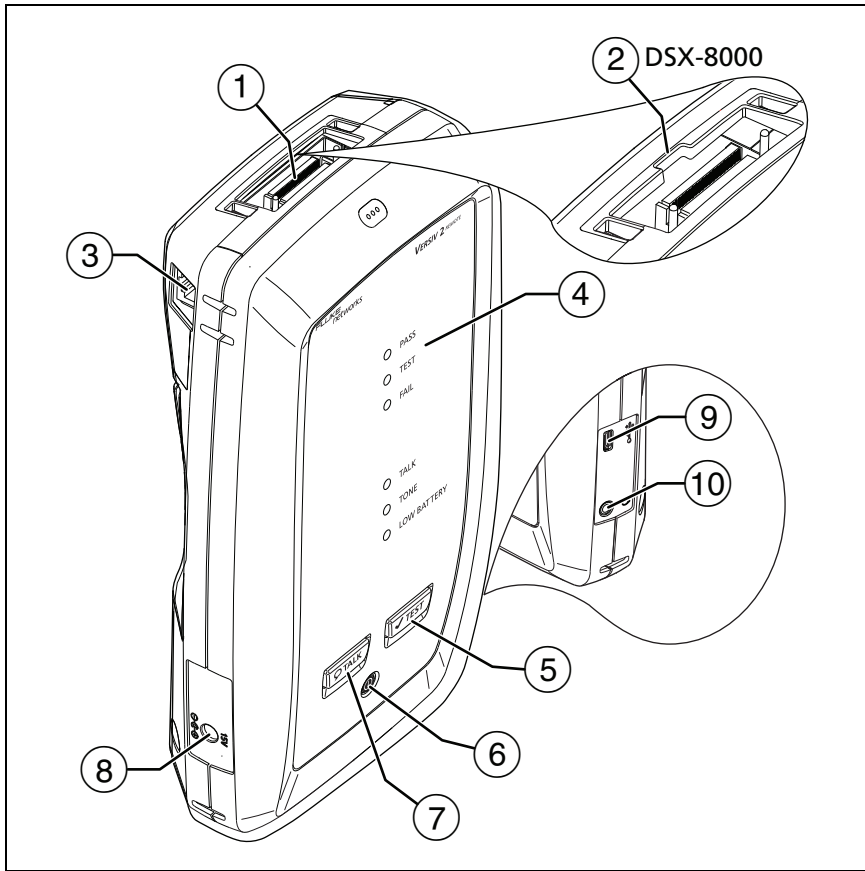

*If you have two main testers, you can use one as a remote. To select the remote function, tap **TOOLS** > **Main as Remote**.*



GPU42.EPS

Figure 8. Remote Tester Connectors, Keys, and LEDs (Versiv 2 shown)

- ① Connector for a link interface adapter
- ② DSX-8000 modules have a recess for the tabs on Cat 8/Class I adapters. You cannot attach Cat 8/Class I adapters to DSX-5000 modules.

- ③ RJ45 jack for communications between the main and remote testers when you do alien crosstalk measurements. See “About the AxTalk Analyzer Kit” on page 63.
- ④ **PASS** LED comes on when a test passes.
TEST LED comes on during a test.
FAIL LED comes on when a test fails.
TALK LED comes on when the talk function is on (⑦). The LED flashes until the main tester accepts the request to talk.
STONE LED flashes and the tone generator comes on if you press  when a main tester is not connected to the remote.
LOW BATTERY LED comes on when the battery is low.
The LEDs also have these functions:
 - Battery gauge (see Figure 1 on page 14)
 - Volume indicator for the **TALK** function
 - Progress indicator for software updates
- ⑤ : Starts a test. Turns on the tone generator if a main tester is not connected to the remote.
- ⑥ ①: Power button. The LED in the power button shows the status of the battery charging process. See Table 2 on page 13.
- ⑦ : Press  to use the headset to speak to the person at the other end of the link. Press again to adjust the volume. To turn off the talk function, hold down .
- ⑧ Connector for the AC adapter. Versiv: The LED is red when the battery charges, and green when the battery is fully charged. The LED is yellow if the battery will not charge. See “Charge the Battery” on page 12.
- ⑨ Micro USB port: This USB port lets you connect the tester to a PC so you can install software updates in the tester.
- ⑩ Headset jack

About Link Interface Adapters

Link interface adapters let you connect the DSX CableAnalyzer to different types of twisted pair links. Figure 9 shows how to attach and remove adapters.

Caution

To prevent damage to the cables on the permanent link adapters and to make sure your test results are as accurate as possible, do not twist, pull on, pinch, crush, or make kinks in the cables. See Figure 10 on page 31.

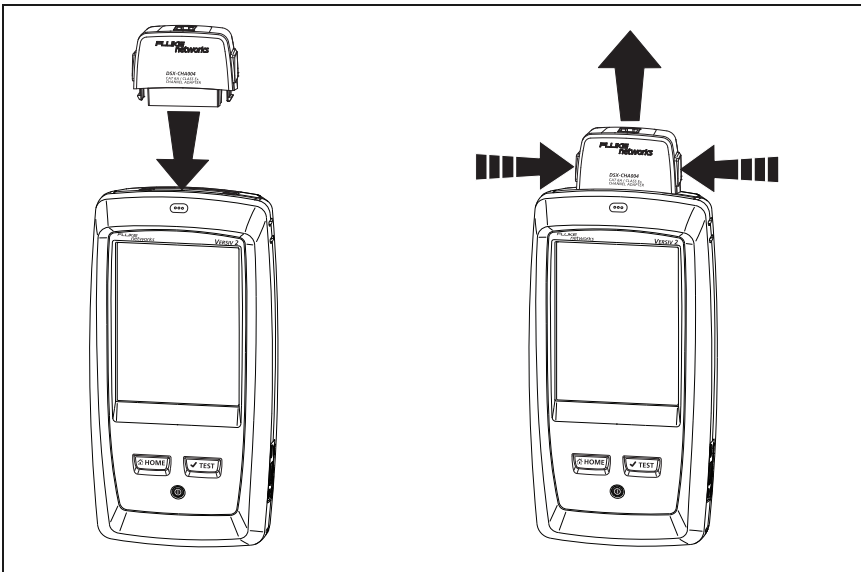

GPU109.EPS

Figure 9. How to Attach and Remove Link Interface Adapters

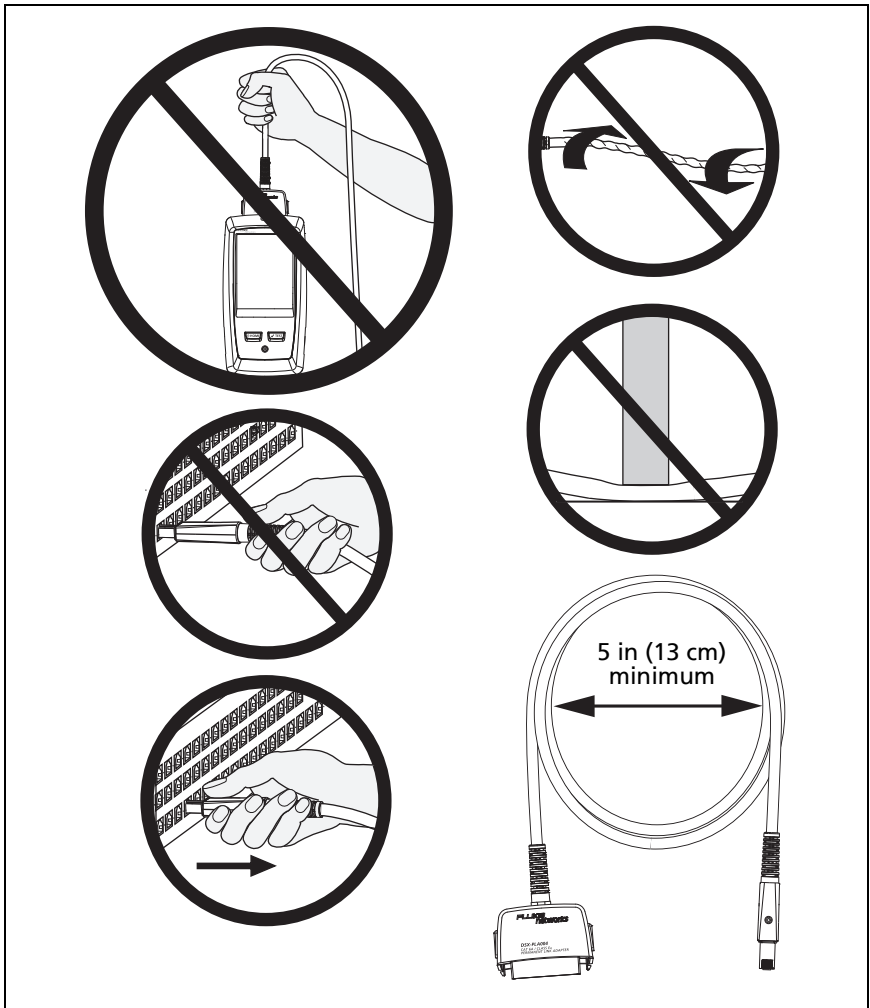

GPU108.EPS

Figure 10. How to Prevent Damage to the Permanent Link Adapter Cables

Adapters for DSX-8000 and DSX-5000 Modules

You can use adapters for test limits up to Cat 7_A/Class F_A and coaxial adapters with DSX-8000 and DSX-5000 modules. Be sure to select a test limit that is appropriate for the adapter.

Cat 8/Class I and Class II adapters, such as the DSX-PLA804 and DSX-CHA-8-GG45, have tabs that lets you attach them only to DSX-8000 modules (see Figure 11).

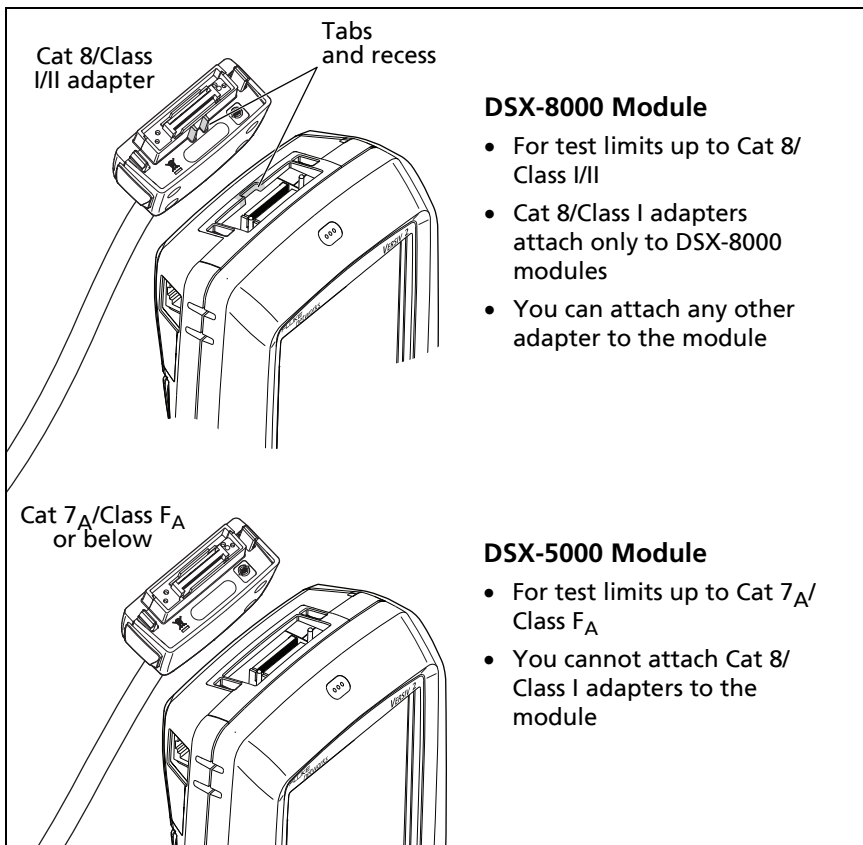
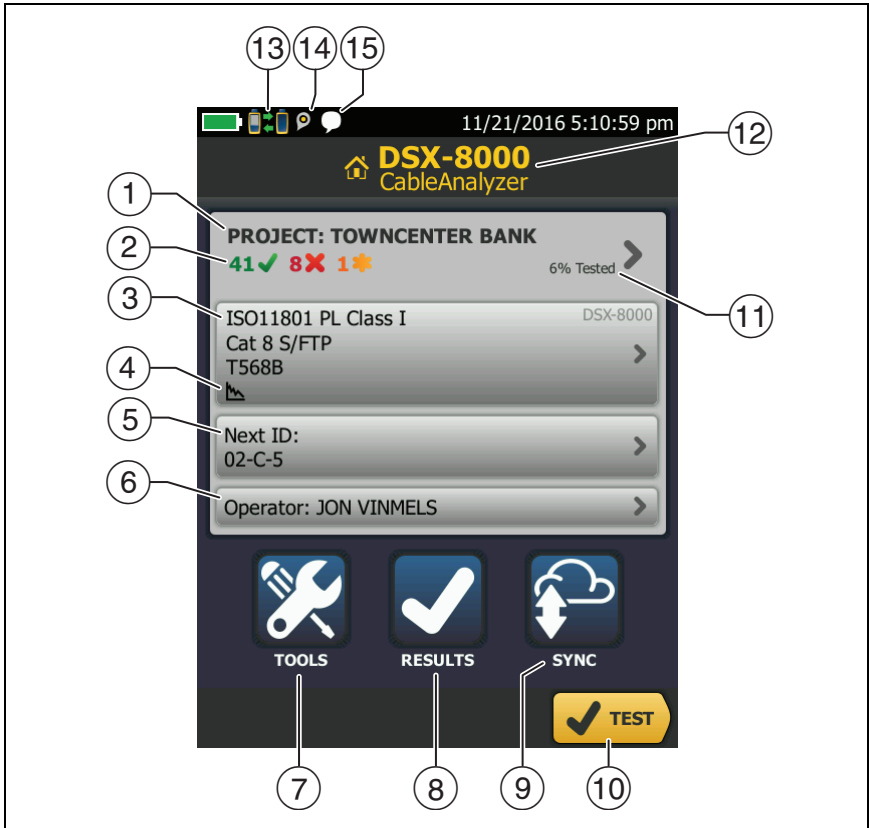

Figure 11. DSX-8000 and DSX-5000 Module and Adapter Differences

The DSX CableAnalyzer Home Screen





The home screen (Figure 12) shows important test settings. Before you do a test, make sure these settings are correct.



GPU110.EPS

Figure 12. The Home Screen for the DSX CableAnalyzer





- ① **PROJECT:** The project contains the settings for a job and helps you monitor the status of a job. When you save test results, the tester puts them in the project. Tap the **PROJECT** panel to edit the project settings, select a different project, or make a new project.

- ② Shows a summary of the test results in the project:
- : The number of tests that passed.
 - : The number of tests that failed.
 - : The number of tests with an overall marginal result.
- ③ The test setup panel shows the settings the tester will use when you tap **TEST** or press . To change these settings, tap the panel.

Note

You can set up tests for any module that the tester can use, even when no module is attached.

- ④ Icons show the status of the **Store Plot Data** and **AC Wire Map** settings. See Table 3 on page 40.
- ⑤ **Next ID:** The **Next ID** panel shows the ID that the tester gives to the next test results you save.
- Tap **Next ID** to do these tasks:
- Enter an ID, select a different ID in the ID set, select a different set of IDs, or make a new set. The tester adds the IDs and ID sets you make to the project that shows on the home screen.
 - Turn **Auto Save** on or off.
- ⑥ **Operator:** The name of the person who does the job. You can enter a maximum of 20 operator names. For each operator you can also enter the email address that the operator will use as an ID to sign in to LinkWare Live.
- ⑦ **TOOLS:** The **TOOLS** menu lets you set the reference, see the status of the tester, and set user preferences such as the language and the display brightness.
- ⑧ **RESULTS:** Tap **RESULTS** to see and manage the results that are saved in the tester.
- ⑨ **SYNC:** Tap **SYNC** to sync projects with LinkWare Live.

- ⑩ **TEST:** Tap **TEST** to do the test shown in the test setup panel.
- ⑪ **% Tested:** The percentage of the project that is completed. The percentage is the number of IDs used for saved results divided by the total number of used and available IDs in the project. The number of IDs includes IDs for copper and fiber cable. Figure 118 on page 298.
- % Tested** does not show if your project contains only a **Next ID** list. See “About Next ID Sets” on page 297 for more information about the **Next ID** list.
- ⑫ The type of module attached to the main tester.
- ⑬  This icon shows when the tester’s link interface adapter is connected to the adapter on a remote tester and the remote is turned on.
-  DSX-5000 only: The arrows on the remote connection icon are orange when the main and remote use long-range communication mode. See “Long-Range Communication Mode (DSX-5000)” on page 63.
- ⑭  The asset management icon shows when the owner of a LinkWare Live account has enabled the asset management service on the tester. “About the Asset Management Service” on page 309.
- ⑮  This icon shows when the talk function is on. To use the talk function:
- 1 Connect the main and remote testers together through a link that has one or more good wire pairs.
 - 2 Connect headsets to the headset jacks on the testers.
 - 3 Press the button on one of the headset microphones or press  on the remote, then speak into the microphone.

Make Sure Your Tester is Ready to Certify Cabling

To make sure your tester meets its accuracy specifications, follow these guidelines:

- Keep the tester's software current. The latest software is available on the Fluke Networks website. See "Update the Software" on page 315.
- Set the reference for the twisted pair adapters every 30 days. See "Set the Reference" below.
- Make sure that you select the correct cable type for the job, and that the NVP for the cable is correct. See Table 3 on page 39.
- Make sure you select the correct test limit for the job. See Table 3 on page 39.
- Make sure the cords and connectors for all test equipment and patch cords are in good condition.
- Make sure the battery is fully charged.
- Send the modules to a Fluke Networks service center every 12 months for factory calibration.

Set the Reference

The reference procedure for twisted pair cable sets the baseline for insertion loss, ACR-F, and DC resistance measurements.

Set the reference at these times:

- When you want to use the tester with a different module. The tester can save reference values for eight different pairs of modules.
- When you attach Class F/F_A or Class I/II link interface adapters, such as the optional TERA or GG45 adapters.
- Every 30 days, at minimum. To ensure maximum accuracy of test results, set the reference daily.

To set the reference

- 1 Install DSX modules in the tester and the remote.
- 2 Turn on the tester and the remote a minimum of 5 minutes before you set the reference.

Note

Set the reference only after the testers are at an ambient temperature between 50 °F and 104 °F (10 °C and 40 °C).

- 3 Use the appropriate adapters or a reference artifact to connect the main and remote testers together as shown in Figure 13.
- 4 On the home screen, tap **TOOLS**, then tap **Set Reference**.
- 5 On the **SET REFERENCE** screen tap **TEST**.

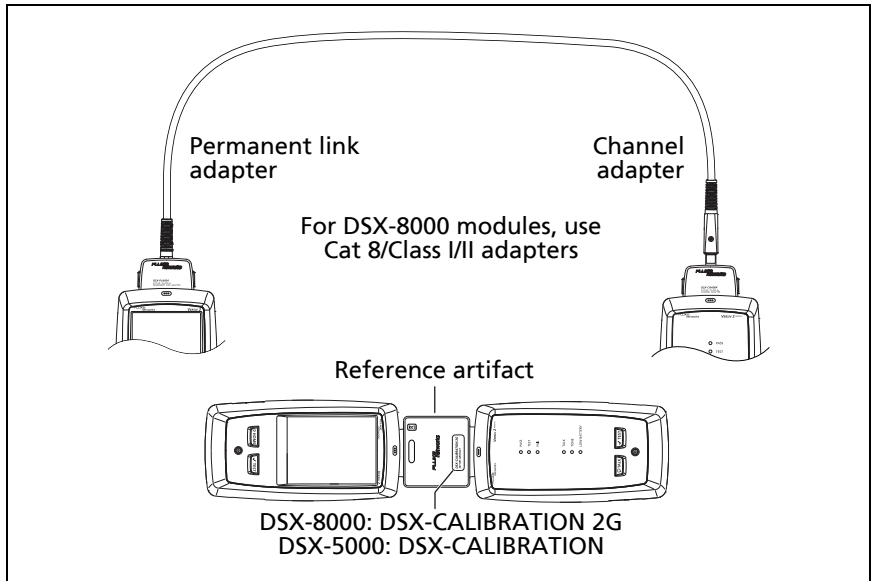

GPU89.EPS

Figure 13. Reference Connections for Twisted Pair Cable

Settings for Twisted Pair Tests



Table 3 gives descriptions of the settings for twisted pair tests. To set up a project, which includes the settings in Table 3, cable IDs, and operator names, see Chapter 13.

To set up a twisted pair test

- 1 On the home screen, tap the test setup panel.
- 2 On the **CHANGE TEST** screen, select a twisted pair test to change, then tap **EDIT**.

Or to set up a new twisted pair test, tap **NEW TEST**. If no module is installed, the **MODULE** screen shows. Tap the correct copper module.
- 3 On the **TEST SETUP** screen, tap the panels to change settings for the test. See Table 3.
- 4 On the **TEST SETUP** screen, tap **SAVE** when your test setup is completed.
- 5 On the **CHANGE TEST** screen, make sure the button next to the test is selected, then tap **USE SELECTED**.

Table 3. Settings for Twisted Pair Tests

Setting	Description
Module	Select DSX-8000 CableAnalyzer or DSX-5000 CableAnalyzer . See Figure 11 on page 32.
Cable Type	Select a cable type that is correct for the type you will test. To see a different group of cable types, tap MORE , then tap a group. To make a custom cable type, tap Custom in the Cable Groups list.
NVP	<p>Nominal velocity of propagation. The tester uses the NVP and the propagation delay to calculate the length of the cable.</p> <p>The default value is defined by the selected cable type and is the typical NVP for that cable type. To enter a different value, tap the NVP panel, then tap  or  on the NVP screen to increase or decrease the value.</p> <p>To find the actual value for a cable, connect a known length of the cable to the tester, tap MEASURE on the NVP screen, then change the NVP until the measured length matches the known length. Use a cable at least 30 m (100 ft) long.</p> <p>When you increase the NVP value, the calculated length increases.</p>
Shield Test	<p>This setting shows only when you select a shielded cable type.</p> <p>On: The wire map test includes a DC test for shield continuity and AC tests for shield quality. The wire map test fails if the shield is open or the AC test results are unsatisfactory.</p> <p>Off: The wire map shows the shield if the shield has continuity. The tester does not do AC tests for shield quality. The wire map test does not fail or show the shield if the shield is open.</p>

-continued-

Table 3. Settings for Twisted Pair Tests (continued)



Test Limit	Select the correct test limit for the job. To see a different group of limits, tap MORE , then tap the name of a group.
Store Plot Data	<p>Off : The tester does not save plot data for frequency-domain tests or for the HDTDR/HDTDX analyzers. You can see the plots before you save the test and exit the results screen. The saved results show frequency-domain measurements in a table and do not include the HDTDR/HDTDX plots.</p> <p>On : The tester saves plot data for all frequency-domain tests required by the selected test limit and for the HDTDR/HDTDX analyzers.</p>
HDTDR/HDTDX	<p>Fail/Pass* only: The tester shows HDTDR and HDTDX analyzer results only for Autotests with PASS*, FAIL*, or FAIL results.</p> <p>All Autotests: The tester shows HDTDR and HDTDX analyzer results for all Autotests.</p> <p>Never: The tester never shows HDTDR or HDTDX analyzer results. This setting also disables the automatic diagnostics, so the FAULT INFO screens never show. To get HDTDR/HDTDX analyzer results you can also tap TOOLS > Diagnostics.</p> <p>For more information about the HDTDR and HDTDX analyzers, see the Technical Reference Handbook.</p>
Bi-directional	<p>This setting shows only when you select a patch cord test limit. It is used mainly by patch cord manufacturers to make the Autotest time shorter.</p> <p>On: The tester does tests in both directions.</p> <p>Off: The tester does tests in only one direction, which decreases the Autotest time.</p>

Table 3. Settings for Twisted Pair Tests (continued)

<p>Outlet Configuration</p>	<p>The Outlet Configuration specifies which wire pairs are tested and which wire numbers the wire map shows for the pairs. See Figures 14 and 15.</p> <p>To see the wire map for a configuration, tap Outlet Configuration, tap the configuration name on the OUTLET CONFIG screen, then tap SAMPLE.</p> <p>To select a configuration, tap a name on the OUTLET CONFIG screen, then tap USE SELECTED.</p> <p style="text-align: center;"><i>Note</i></p> <p style="text-align: center;"><i>The OUTLET CONFIG screen shows only the configurations that are applicable to the selected Test Limit.</i></p> <p>To make a custom outlet configuration, tap CUSTOM on the OUTLET CONFIG screen, then tap MANAGE, then tap Create.</p>
<p>AC Wire Map</p>	<p>The AC Wire Map test lets you do tests on links connected through midspan PoE (Power over Ethernet) devices. See the Technical Reference Handbook.</p> <p>When the AC Wire Map test is on, this icon shows on the home screen: </p> <p style="text-align: center;"><i>Notes</i></p> <p style="text-align: center;"><i>Always turn off the AC wire map test when you will not do tests through a PoE device. The AC wire map test increases the time for an Autotest. It also disables the resistance and shield continuity tests.</i></p> <p style="text-align: center;"><i>The DSX-8000 modules do not support the AC wire map test.</i></p>

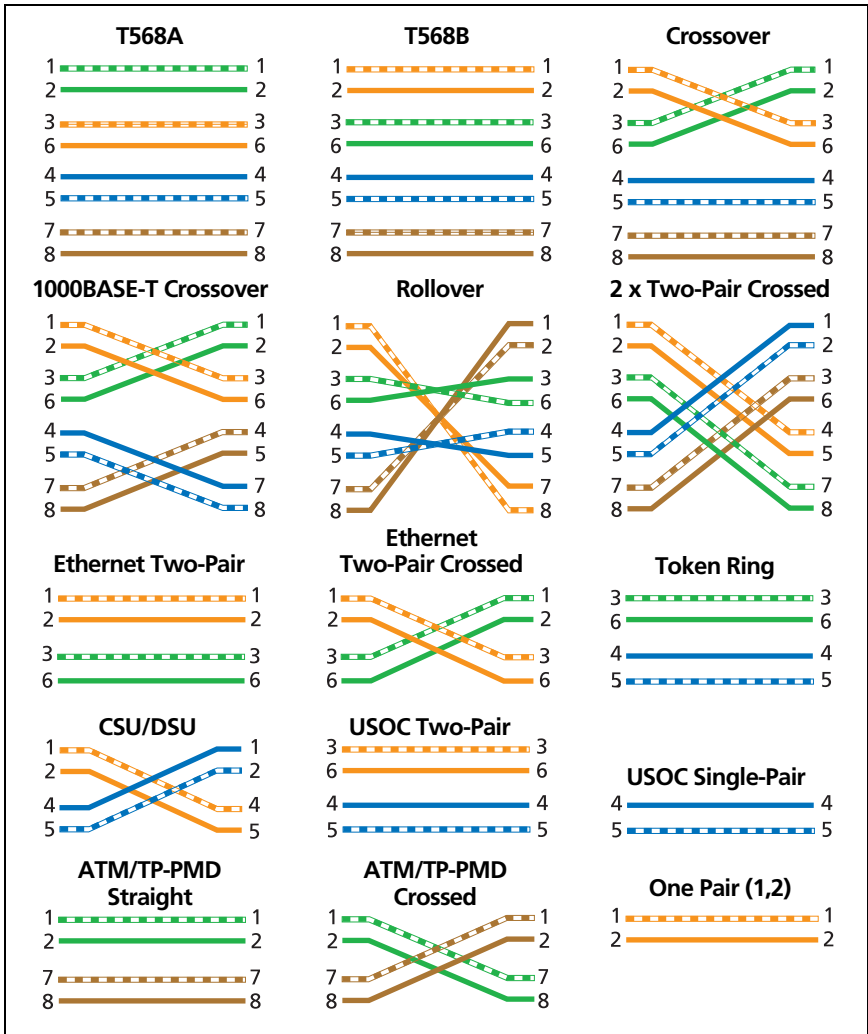

GPU85.EPS

Figure 14. Outlet Configurations - RJ45

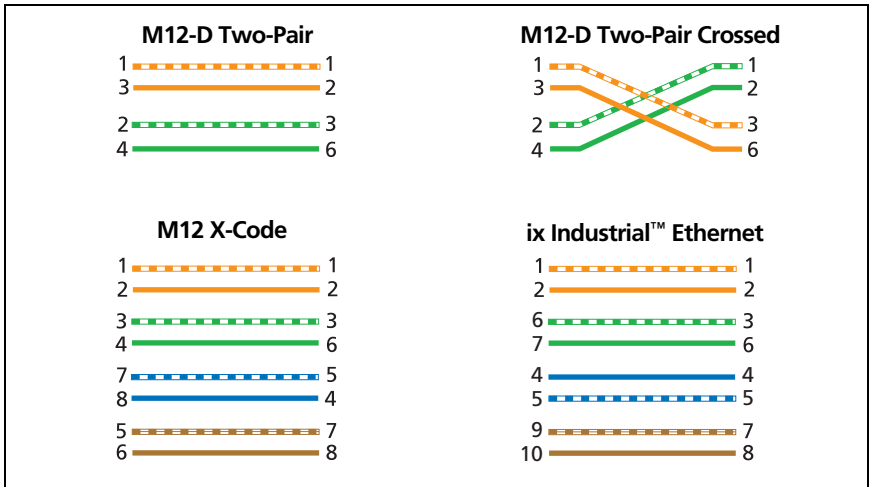

GPU238.EPS

Figure 15. Outlet Configurations - Industrial Ethernet

How to Do an Autotest

When you tap **TEST** on the main tester or press **TEST** on the main or remote tester, the testers do an Autotest. The Autotest includes all the tests necessary to certify that the cabling meets or exceeds the performance requirements specified in the selected test limit.

Figure 16 shows the equipment for Autotests on twisted pair cable.

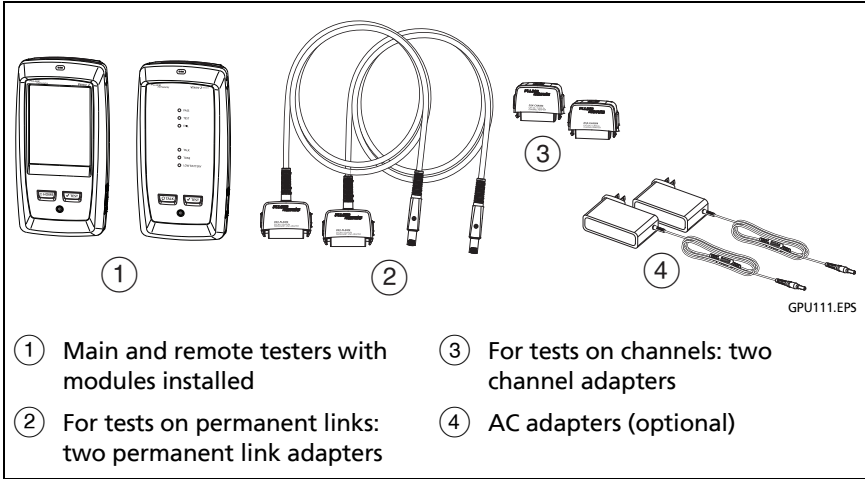



Figure 16. Equipment for Autotests on Twisted Pair Cable

To do an Autotest on twisted pair cable

- 1 Attach permanent link or channel adapters to the main and remote testers.
- 2 Make sure that the home screen shows the correct settings for the job.

To make sure that other settings are correct, tap the test setup panel, make sure the correct test is selected on the **CHANGE TEST SCREEN**, then tap **EDIT** to see more settings. Table 3 on page 39 describes the settings.

- 3 Connect the testers to the link as shown in Figure 17, 18, 19, 20, or 21.
- 4 Tap **TEST** on the main tester or press  on the main or remote tester.

If the tester at the other end of the cable is in sleep mode or is off, your tester's tone generator turns on the other tester.

If the two testers are not connected:

- Your tester's tone generator stays on. Then, you can use a tone probe if necessary to find the cable to connect to the other tester.
- Or, tap **MEASURE** to do the tests that do not require a remote tester. Because the tester cannot complete all tests and some tests always fail with no remote connected, the result for an Autotest without a remote is always **FAIL**.

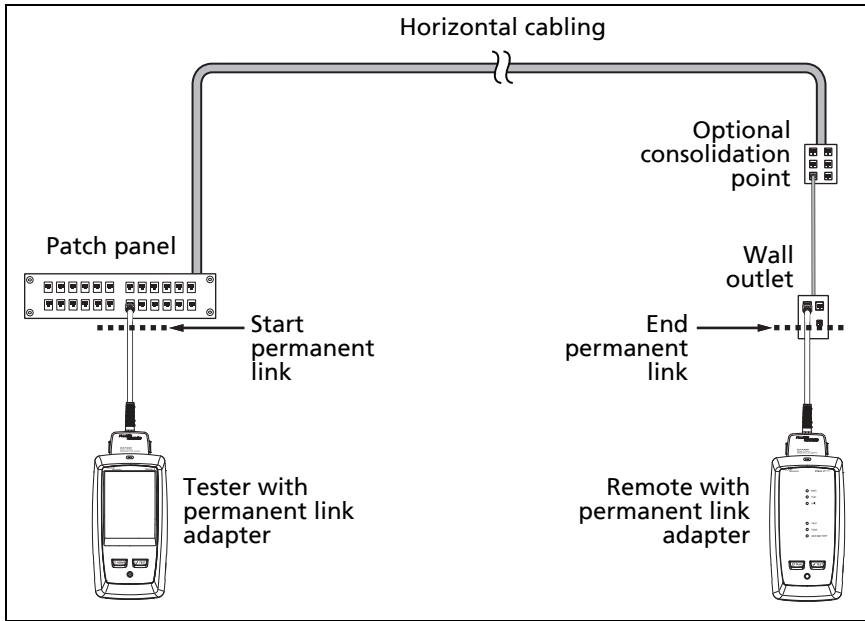

GPU97.EPS

Figure 17. Permanent Link Connections for Links Up to Cat 7_A

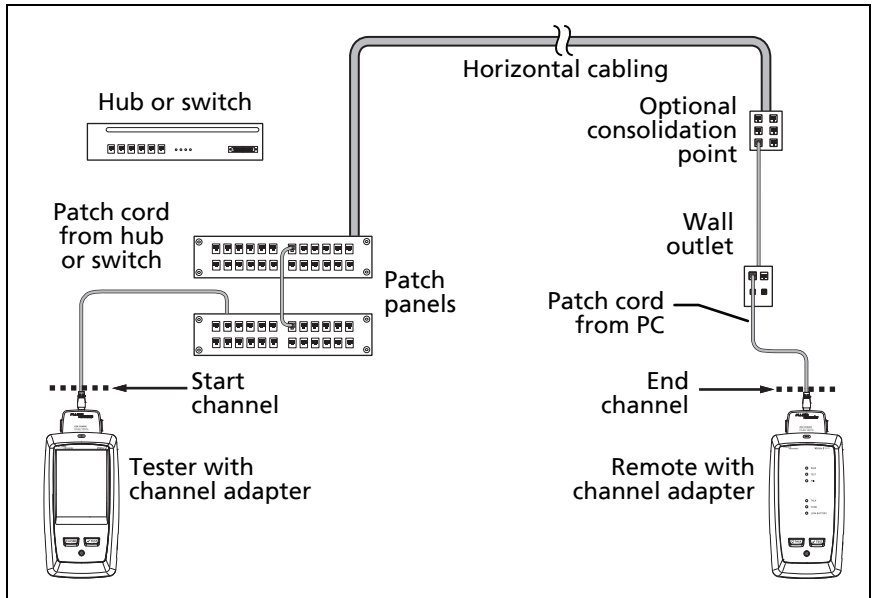

GPU96.EPS

Figure 18. Channel Connections for Links Up to Cat 7_A

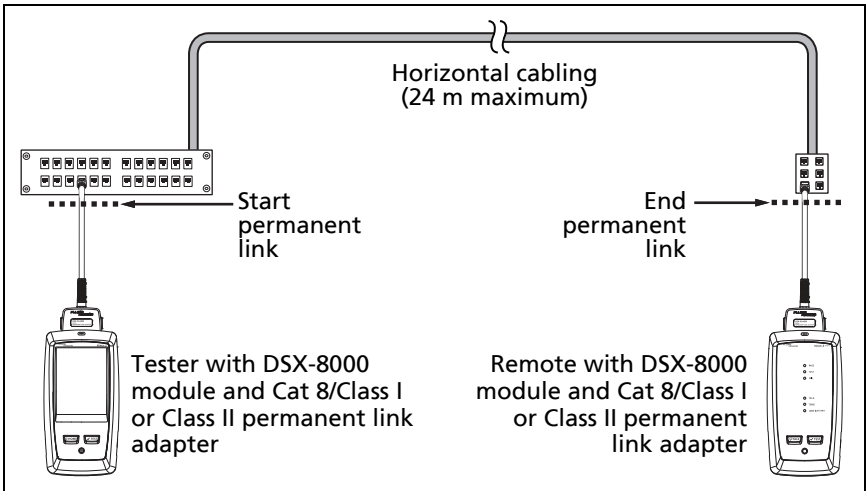

GPU201.EPS

Figure 19. Permanent Link Connections for Cat 8/Class I/II Links

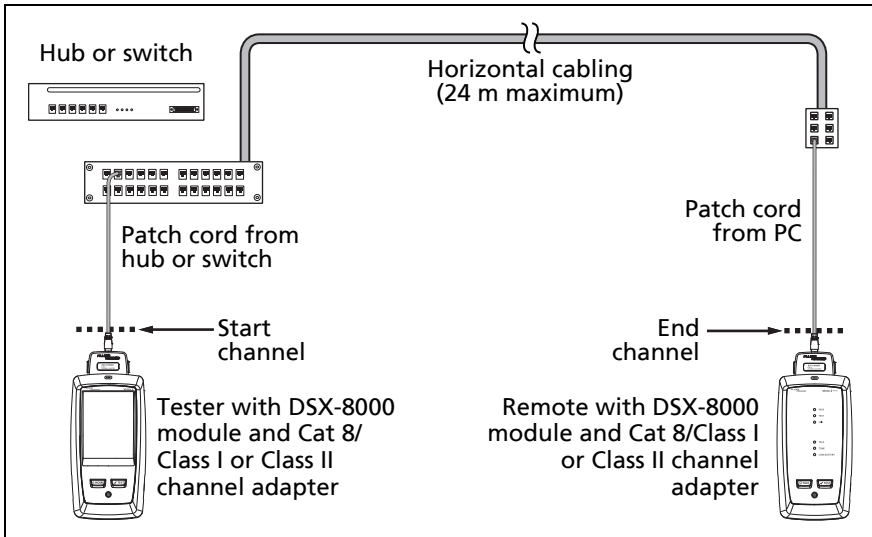

GPU202.EPS

Figure 20. Channel Connections for Cat 8/Class I/II Links

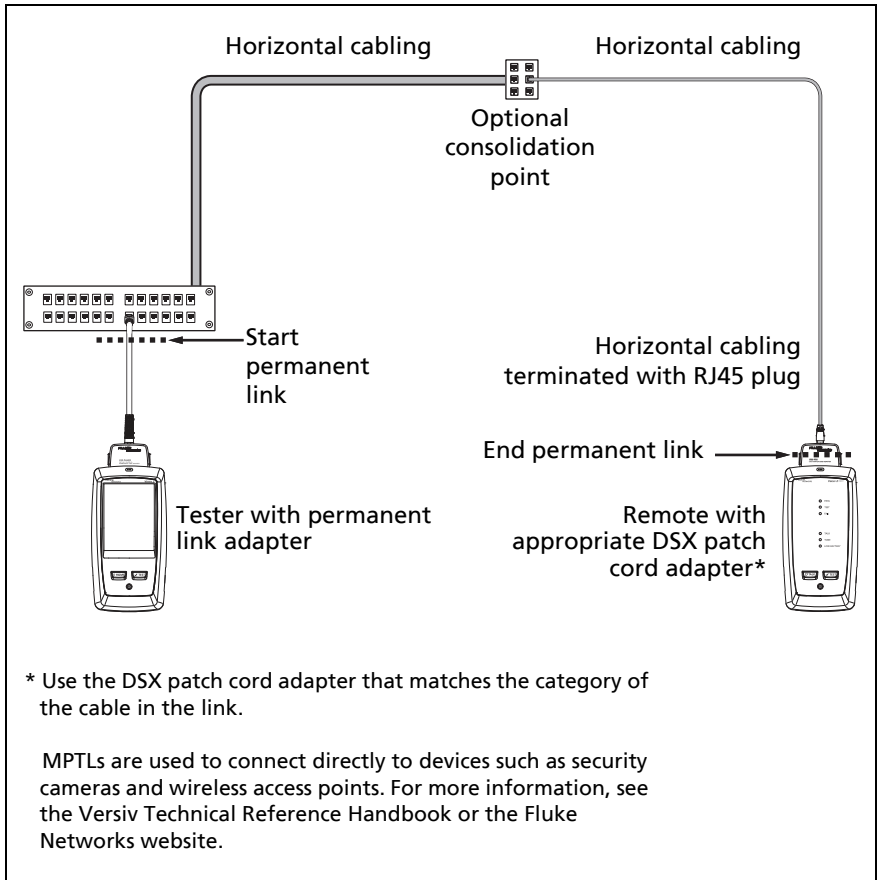

GPU239.EPS

Figure 21. Connections for Modular Plug Terminated Links (MPTL)

“Bad Patch Cord” Message

To comply with standards for tests on channels, the tester removes the effects of the channel adapters and their connections from the test results. Before it removes these effects, the tester makes sure that the plugs on the patch cord do not

have too much near-end crosstalk (NEXT). Too much NEXT is frequently caused by too much untwisted wire in the plug. If a plug is bad, the tester shows the message **Bad patch cord at main** or **Bad patch cord at remote**, and does not remove the effects of the channel adapters and their connections. The tester saves the message with the results.

If you see one of these messages, replace the patch cord or install a new plug at the bad end.

How to Certify Patch Cords

To certify patch cords, you must use the DSX-PCxx Patch Cord Adapters and the correct patch cord test limit. You cannot use channel adapters and test limits to certify patch cords because channel tests do not measure the performance of the patch cord plugs.

To purchase a DSX-PCxxS Patch Cord Adapter Set, contact an authorized Fluke Networks distributor.

Twisted Pair Autotest Results

The tests listed below apply to twisted pair cabling.

Note

Some tests are not included in some test limits.

- Wire map
- Resistance
- Resistance unbalance in a pair (in limits with **(+PoE)** and others)
- Resistance unbalance between pairs (in limits with **(+PoE)** and others)
- Length
- Propagation delay
- Delay skew

- Insertion loss (attenuation)
- Impedance
- NEXT (near-end crosstalk)
- PS NEXT (power-sum near-end crosstalk)
- ACR-N (attenuation to crosstalk ratio at the near end)
- PS ACR-N (power-sum attenuation to crosstalk ratio, near end)
- ACR-F (attenuation to crosstalk ratio at the far end)
- PS ACR-F (power-sum attenuation to crosstalk ratio, far end)
- Return loss
- TCL (transverse conversion loss, in limits with **(+All)**)
- CDNEXT (common-mode to differential mode near-end crosstalk, in limits with **(+All)**)
- CMRL (common-mode return loss, in limits with **(+All)**)
- ELTCTL (equal level transverse conversion transfer loss, in limits with **(+All)**)
- HDTDR and HDTDX analyzers (optional tests, not required by any test limit)

Automatic Diagnostics

If an Autotest on twisted pair cabling fails, the DSX CableAnalyzer automatically gives you information about faults. To see the information, tap the **FAULT INFO** tab. Figure 22 shows examples of diagnostic information.

To get only diagnostics results, select **Diagnostics** from the **TOOLS** menu. These results do not include a **PASS/FAIL** status.

The diagnostic screens show connectors in grey when other faults possibly affect the results for the connector.

For NEXT failures caused by multiple connectors, the diagnostic screen shows the worst connector in red.

Future Versiv software releases may include additional diagnostics. The latest software is available at no charge on the Fluke Networks website.

For more information on diagnostics, including video training modules, see the Knowledge Base on the Fluke Networks website.

Note

*The **FAULT INFO** tab does not show if you select **Never** for the **HDTDR/HDTDX** setting on the **TEST SETUP** screen.*

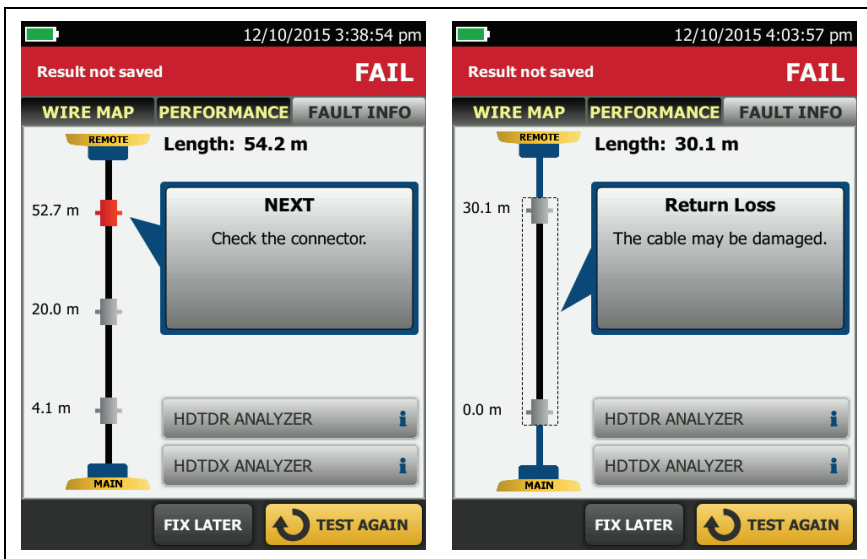

GPU192.EPS

Figure 22. Examples of Fault Information Screens

PASS*/FAIL* Results

A result shows an asterisk when measurements are in the tester's accuracy uncertainty range (Figure 23) and the asterisk is required by the selected test limit. These results are marginal.

- 🌸 A **PASS*** shows that the cable's performance is satisfactory. If a cable must get a **PASS** result to agree with your requirements for quality, identify and correct the problems with the cable and do the Autotest again.
- 🌸 Usually, a **FAIL*** is not a satisfactory result. The tester shows a **FAIL** for the overall result. Identify and correct the problems with the cable and do the Autotest again.

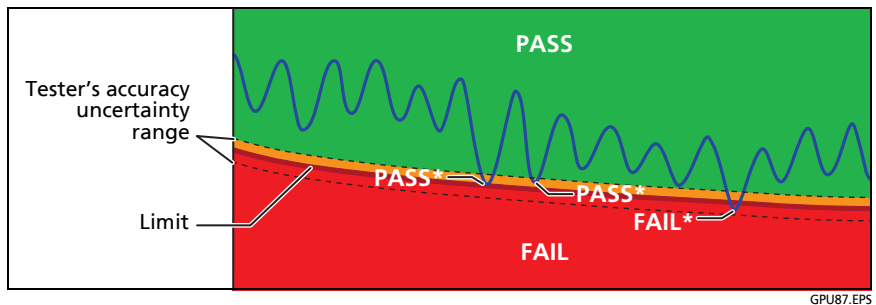

Figure 23. PASS* and FAIL* Results

WIRE MAP Tab

The **WIRE MAP** tab shows the connections between the ends of the cable under test. The tester compares the connections to the selected **Outlet Configuration** to get a **PASS** or **FAIL** result.



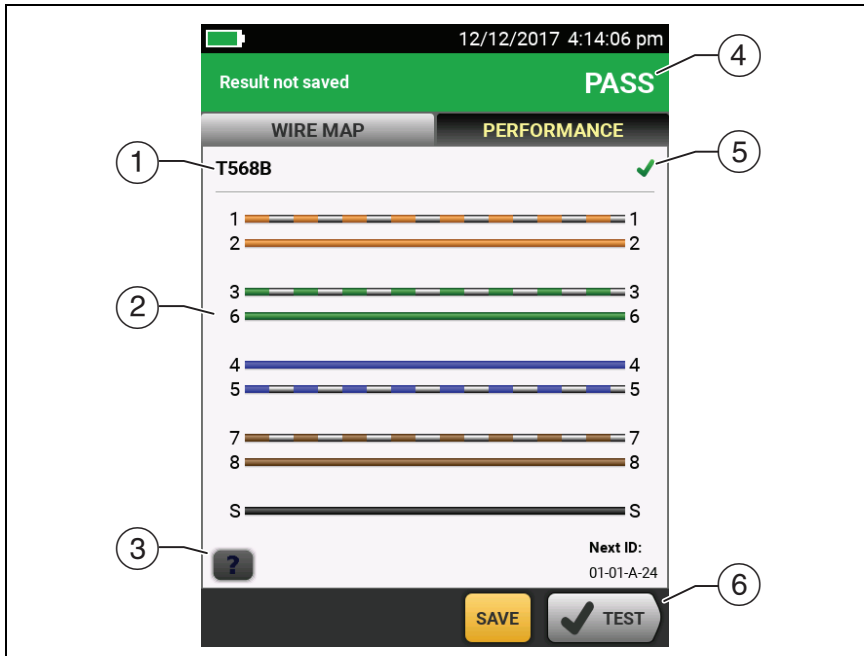

If the wire map test fails, you can continue or stop the Autotest. Or, you can tap **SCAN ON** to do the wire map test continuously while you look for the fault. To continue the Autotest after you correct the fault, tap **SCAN OFF**, then tap **CONTINUE**.

If you leave then return to the **WIRE MAP FAIL** screen, the **SCAN ON** button goes away. To see the button again, tap **TEST AGAIN**. You can also select the continuous wire map test as a single test from the **TOOLS** menu. See "Continuous Tests" on page 62.

Figure 24 shows an example of a wire map screen. For information on AC wire map screens, see the Technical Reference Handbook.



GPU59.EPS

- ① The name of the outlet configuration used for the test. The outlet configuration is a setting on the **TEST SETUP** screen.
- ② The wire map of the cabling. The main tester is at the left side of the wire map.
- ③ Tap  to see information about wire map faults. If  shows, tap it to see a message about the results, such as **Bad patch cord at remote**.
- ④ The overall result for the Autotest. If the result shows an asterisk, See "PASS*/FAIL* Results" on page 53.
- ⑤ The result for the wire map test:
 -  The wire map does not agree with the outlet configuration selected for the test.
 -  The wire map agrees with the outlet configuration selected for the test.
- ⑥ When more than one button shows at the bottom of the screen, the tester highlights one in yellow to recommend which one to tap. See "Buttons to Do Tests and Save Results" on page 19.

PERFORMANCE Tab

The **PERFORMANCE** tab (Figure 25) shows the overall result for each test that is required by the selected test limit.

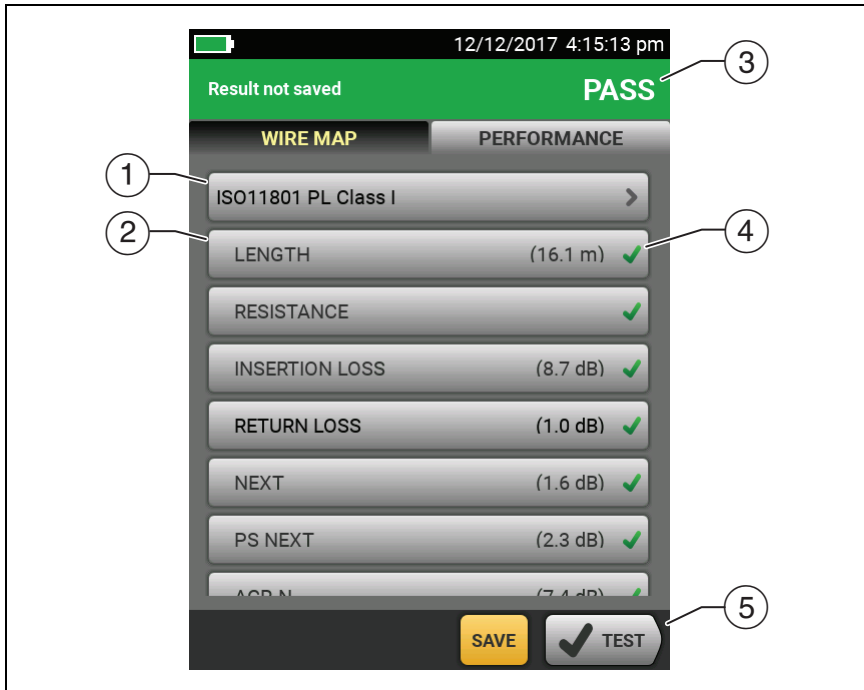



GPU86.EPS

Figure 25. PERFORMANCE Tab

- ① The test limit and cable type used for the test. To see all the settings used for the test, tap the panel.
- ② To see detailed results for a test, tap the panel.
- ③ The overall result for the Autotest. If the result shows an asterisk, See "PASS*/FAIL* Results" on page 53.
- ④ The overall result for the test:

✘ The results exceed the limit.

 The results are within the limit.

 The selected test limit does not have a limit for the test, or a dB rule applies. See the Technical Reference Handbook.

 The results are within the range of accuracy uncertainty for the tester. See “PASS*/FAIL* Results” on page 53.

The measurement shown for frequency-domain results is the worst margin. (The insertion loss plot is different. See the Technical Reference Handbook.)

- ⑤ When more than one button shows at the bottom of the screen, the tester highlights one in yellow to recommend which one to tap. See “Buttons to Do Tests and Save Results” on page 19.

Frequency-Domain Results

Frequency-domain results are the measurements that change with frequency, such as insertion loss and crosstalk.

How to Save Frequency-Domain Results as a Plot or a Table

If **Store Plot Data** is on when you do a test, the saved results show as plots. If **Store Plot Data** is **Off**, the tester does not save plot data for frequency-domain tests or for the HDTDR/HDTDX analyzers. You can see the plots before you save the test and exit the results screen. Figures 26 and 27 show examples of the two types of screens. Also see “Store Plot Data” on page 40.

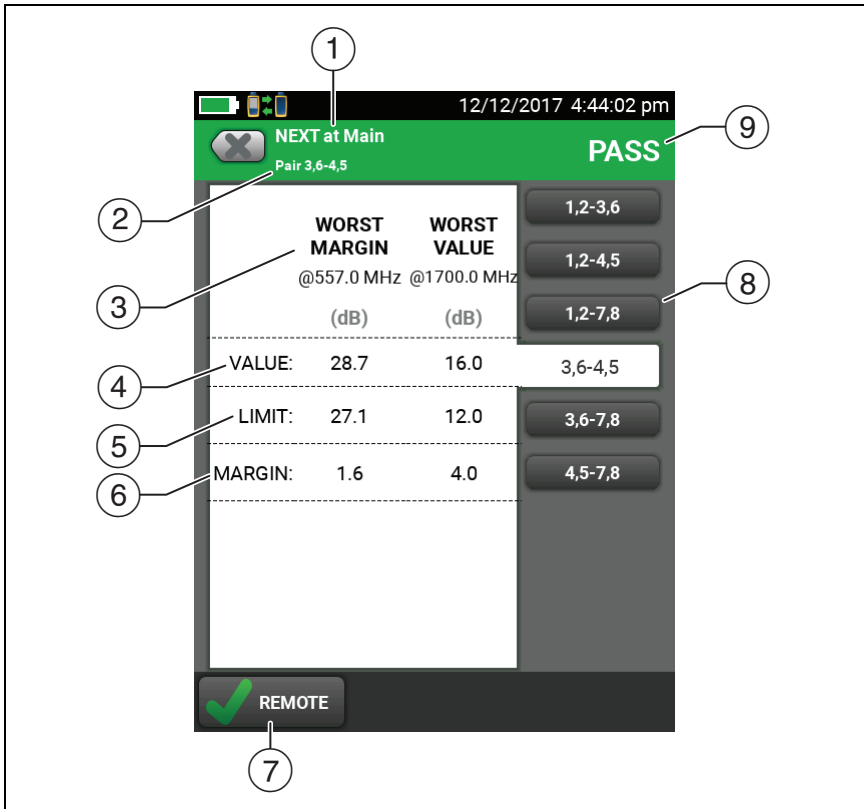

GPU104.EPS

Figure 26. Tabular Results Screen for a Frequency-Domain Test

- ① The location where the tester made the measurements. To switch between results for the main and remote, tap **REMOTE** or **MAIN** (7).
- ② The results are for the wire pair or pairs shown. To see the results for a different pair or pairs, tap a tab on the right side of the screen (8).
- ③ **WORST MARGIN** is the measurement that is nearest to the limit line or exceeds the limit by the largest amount. **WORST VALUE** is the worst measurement.

- ④ The measured value.
- ⑤ The limit specified by the selected test limit.
- ⑥ **MARGIN** is the difference between the measured value and the limit. The value is in a red box if the measurement exceeds the limit.
- ⑦ To switch between results for the main unit and the remote, tap **REMOTE** or **MAIN**.
- ⑧ To see the results for a different pair or pairs, tap a tab.
- ⑨ The result for the pair. If the result shows an asterisk, see "PASS*/FAIL* Results" on page 53.

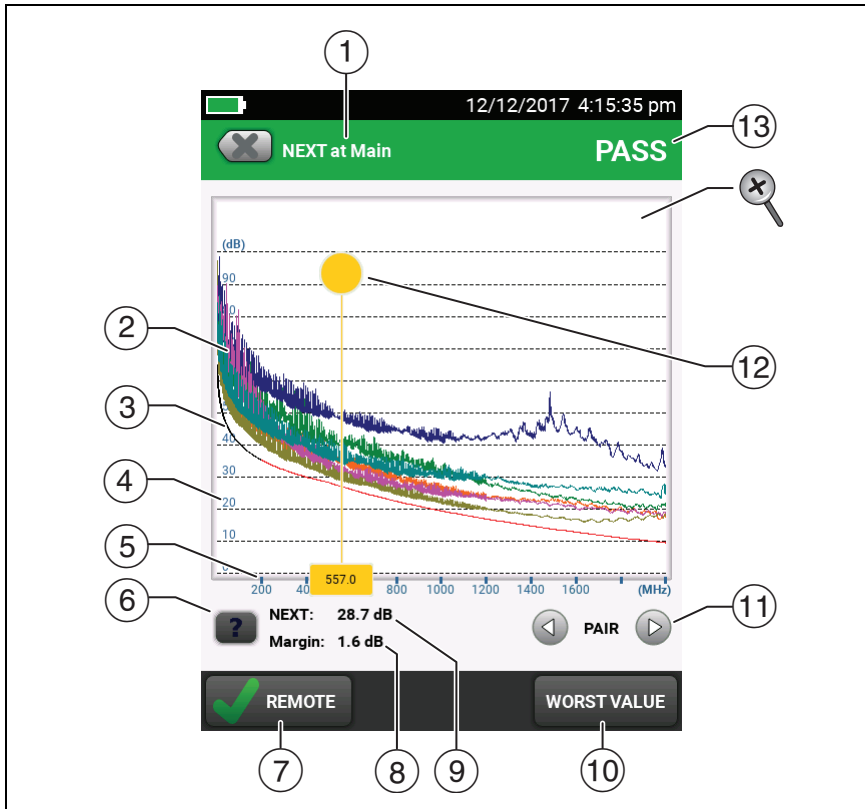





GPU71.EPS

Figure 27. Plot Screen for a Frequency-Domain Test



- ① The location of the measurements. To switch between results for the main and remote, tap **REMOTE** or **MAIN** (⑦).
- ② Measured values for the wire pairs.
- ③ The limit line (in red) for the measurement.

Note

If the limit line is black, the tester does not evaluate the measurement at those frequencies because a dB rule applies. See the Technical Reference Handbook.

- ④ The vertical scale is the measured value in decibels.
 - ⑤ The horizontal scale is the frequency range in megahertz.
 - ⑥ To see help for the screen, tap .
 - ⑦ To switch between results for the main unit and the remote, tap **REMOTE** or **MAIN**.
 - ⑧ The margin at the cursor's location. The margin is the difference between the measured value and the limit. The margin is negative if the pair failed.
 - ⑨ The measured value at the cursor's location.
 - ⑩ When you first look at the plot, the cursor is at the frequency of the worst margin. To move the cursor to the worst value, tap **WORST VALUE**. (The insertion loss plot is different. See the Technical Reference Handbook.)
 - ⑪ To see the plots for pairs, tap  or . To select pairs to show on the plot, touch  or  for one second to see the **SELECT PAIRS** window. Select the pairs you want to see, then tap **OK**.
 - ⑫ When you first look at the plot, the cursor is at the frequency of the worst margin. To move the cursor to the worst value, tap **WORST VALUE** (⑩). The box at the bottom of the cursor shows the frequency at the cursor's position.

To move the cursor to other points, touch and drag the yellow circle at the top of the cursor.



To move the cursor in small increments, tap the yellow circle, then tap the arrow buttons that show on the plot ( or .
 - ⑬ The overall result for the test. If you look at pairs, the result is for those pairs. If the result shows an asterisk, see "PASS*/FAIL* Results" on page 53.
-  To zoom in and out, use the pinch, reverse-pinch, and double-tap gestures on the touchscreen. You can also use the zoom controls to change the magnification on the frequency and decibels scales independently. See Figure 3 on page 18.

DIAGNOSTIC and FAULT INFO Tabs

If the Autotest failed or had a marginal result, the **FAULT INFO** tab shows. If the test passed and you selected **All Autotests** for the **HDTDR/HDTDX** setting on the **TEST SETUP** screen, the **DIAGNOSTIC** tab shows. These tabs give you access to the HDTDR and HDTDX analyzer plots. The plots help you locate the causes of NEXT and return loss failures. See the Technical Reference Handbook.

Continuous Tests

To do the wire map, length, or resistance test continuously, go to the home screen, tap **TOOLS > Single Tests**, then tap a test.

The wire map test compares the results to the outlet configuration specified by the selected test limit and shows  if the connections agree or  if they do not.

The length and resistance tests do not compare the results to a test limit.

To save the result, tap **SCAN OFF > SAVE**. The saved test has an  for the overall result.

Long-Range Communication Mode (DSX-5000)

DSX-5000 modules have a long-range communication mode that lets you do tests on very long cables, such as spools of cable and long links used for voice communications. The DSX-5000 automatically uses this mode when the cable is too long for normal communications between the main and remote testers. For example, a Cat 6 cable longer than approximately 200 m will cause the testers to use long-range communication mode.

When the testers use long-range communication mode, the arrows on the connection icon are orange: 

Note

Tests take more time to complete in long-range communication mode. For example, an Autotest can take 90 seconds to two minutes to complete.

A very long cable will fail the Autotest, but you can measure cable length and compare other results to results from a known- good cable of the same length to see if the cable is good.

About the AxTalk Analyzer Kit

The DSX CableAnalyzer kit includes the hardware and AxTalk Analyzer software you need to do tests for alien crosstalk on twisted pair cabling. Alien crosstalk is noise, or crosstalk, transmitted between adjacent cables in a bundle or patch panel. Alien crosstalk is a primary source of noise in cabling used for 10GBASE-T applications and above.

For instructions on how to do alien crosstalk tests, install the AxTalk Analyzer software, which is available on the Fluke Networks website, then see the online help in the software.

Chapter 3: Certify Coaxial Cabling

The optional DSX-CHA003 coaxial adapters let you use the DSX CableAnalyzer to certify coaxial cabling for network and video applications.

Set the Reference for Coaxial Tests

To use DSX-CHA003 adapters, you must set the reference for coaxial tests. The reference procedure sets a baseline for insertion loss and resistance measurements.

Set the reference at these times:

- When you want to use the tester with a different module. The tester can save reference values for eight different pairs of modules.
- Every 30 days, at minimum.
- To ensure maximum accuracy of test results, set the reference daily.

Note

It is not necessary to set the reference again if you use different coaxial adapters.

To set the reference

- 1 Make the connections shown in Figure .
- 2 Turn on the tester and the remote a minimum of 5 minutes before you set the reference.

-continued-

Notes

Set the reference only after the testers are at an ambient temperature between 10 °C and 40 °C (50 °F and 104 °F).

The tester will not let you set the reference if the patch cord is longer than 30 cm (12 in).

You can also set the reference with a 50 Ω patch cord.

- 3 On the home screen, select a coaxial cable test.
- 4 On the home screen, tap **TOOLS**, then tap **Set Reference**.
- 5 On the **SET REFERENCE** screen tap **TEST**.

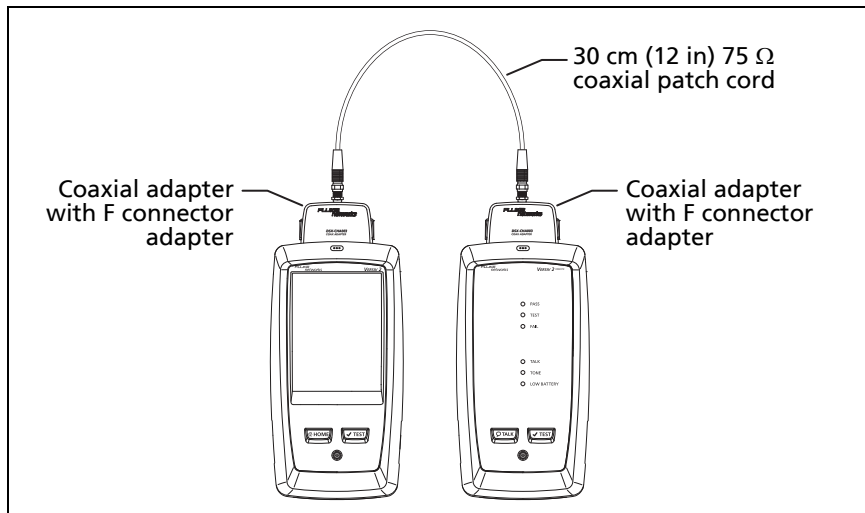

Figure 28. Reference Connections for Tests on Coaxial Cabling

GPU179.EPS

Settings for Coaxial Tests





Table 4 gives descriptions of the settings for coaxial tests. To set up a project, which includes the settings in Table 4, cable IDs, and operator names, see Chapter 13.

To set up a coaxial test

- 1 On the home screen, tap the test setup panel.
- 2 On the **CHANGE TEST** screen, select a coaxial test to change, then tap **EDIT**.

Or to set up a new coaxial test, tap **NEW TEST**. If no module is installed, the **MODULE** screen shows. Tap **DSX-8000 CableAnalyzer** or **DSX-5000 CableAnalyzer**.
- 3 On the **TEST SETUP** screen, tap the panels to change settings for the test. See Table 4.
- 4 On the **TEST SETUP** screen, tap **SAVE** when your test setup is completed.
- 5 On the **CHANGE TEST** screen, make sure the button next to the test is selected, then tap **USE SELECTED**.

Table 4. Settings for Coaxial Tests

Setting	Description
Module	Select DSX-8000 CableAnalyzer or DSX-5000 CableAnalyzer .
Cable Type	Select a cable type that is correct for the type you will test. To see a different group of cable types, tap MORE , then tap a group. To make a custom cable type, tap Custom in the Cable Groups list.
NVP	<p>Nominal velocity of propagation. The tester uses the NVP and the propagation delay to calculate the length of the cable.</p> <p>The default value is defined by the selected cable type and is the typical NVP for that cable type. To enter a different value, tap the NVP panel, then tap  or  on the NVP screen to increase or decrease the value.</p> <p>To find the actual value for a cable, connect a known length of the cable to the tester, tap MEASURE on the NVP screen, then change the NVP until the measured length matches the known length. Use a cable at least 30 m (100 ft) long.</p> <p>When you increase the NVP value, the calculated length increases.</p>
Test Limit	Select the correct test limit for the job. To see a different group of limits, tap MORE , then tap the name of a group.
Store Plot Data	<p>Off : The tester does not save plot data for insertion loss or for the HDTDR analyzer. You can see the plots before you save the test and exit the results screen. The saved results show insertion loss measurements in a table and do not include the HDTDR plot.</p> <p>On : The tester saves plot data for the insertion loss test and for the HDTDR analyzer.</p>

How to Do an Autotest

Figure 29 shows the equipment for tests on coaxial cabling.

Notes

You can do the HDTDR, length, and resistance tests without a remote tester. See “Tests Without a Remote” on page 74.

*If you have two main testers, you can use one as a remote. To select the remote function, tap **TOOLS** > **Main as Remote**.*

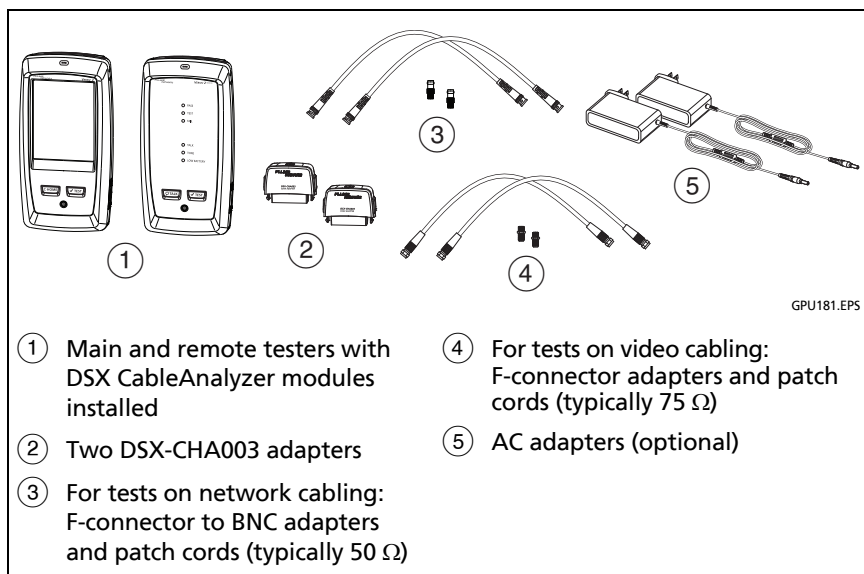

Figure 29. Equipment for Tests on Coaxial Cabling

To do an Autotest

- 1 Attach coaxial adapters to the main and remote testers.
- 2 Make sure that the home screen shows the correct settings for the job.

To make sure that other settings are correct, tap the test setup panel, make sure the correct test is selected on the **CHANGE TEST** screen, then tap **EDIT** to see more settings. Table 4 on page 68 describes the settings.

- 3 Connect the testers to the link as shown in Figure 30.

Caution

To make sure your results are reliable:

- Disconnect all taps and devices from the cable.
 - Do not do tests through splitters (See “About Splitters” on page 73).
- 4 Tap **TEST** on the main tester or press  on the main or remote tester.

If the tester at the other end of the cable is in sleep mode or is off, your tester’s tone generator turns on the other tester.

If the two testers are not connected:

- Your tester’s tone generator stays on so you can use a tone probe to find the cable to connect to the other tester.
- Or, tap **MEASURE** to do the length and resistance tests, which do not require a remote tester. Because the tester cannot complete all tests, and the reflection at the end of the cable exceeds the 15% limit for the HDTDR test, the result for an Autotest without a remote is always **FAIL**.

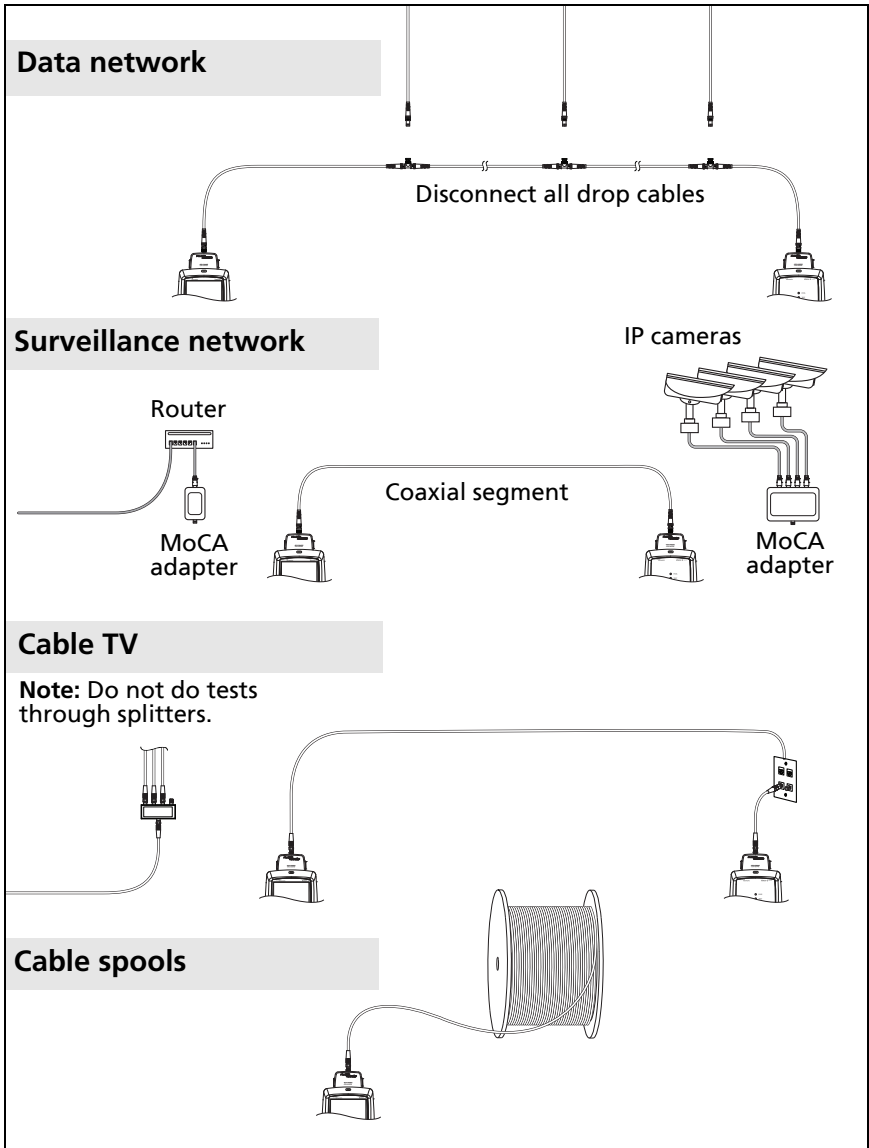

GPU184.EPS

Figure 30. Examples of Connections for Tests on Coaxial Cabling

Coaxial Autotest Results

Note





Not all test limits include all the tests shown in Figure 31.



Figure 31. Autotest Results for Coaxial Cabling

GPU182.EPS

- ① The test limit and cable type used for the test.
- ② To see detailed results for a test, tap the panel.
- ③ The overall result for the Autotest. If the result shows an asterisk, See "PASS*/FAIL* Results" on page 53.

- ④ The **DIAGNOSTIC** tab shows the HDTDR analyzer button, which you can tap to see the HDTDR plot. The plot helps you find faults on the cable. The HDTDR plot for coaxial cable includes limit lines and a **PASS/FAIL** result.
- ⑤ The overall result for the test:
 -  The results exceed the limit.
 -  The results are within the limit.
 -  The selected test limit does not have a limit for the test.
 -  The results are within the range of accuracy uncertainty for the tester. See "PASS*/FAIL* Results" on page 53.

The measurement shown for the insertion loss plot is the worst value if the test passed, or the worst margin if the test failed.
- ⑥ When more than one button shows at the bottom of the screen, the tester highlights one in yellow to recommend which one to tap. See "Buttons to Do Tests and Save Results" on page 19.

To do the resistance test continuously, select the test from the **TOOLS** menu. This function helps you locate intermittent faults.

About Splitters

If you get these results, there might be a splitter on the cable:

- The tester cannot find the remote.
- The tester loses communication with the remote. The test might continue, then lose communication again as the splitter interferes with the communication signal.
- The length test shows **End not found**.
- The resistance test shows an open.
- The HDTDR plot shows a reflection that has an unusual shape.

Because splitters can cause unreliable test results, you should not do tests through them.

Tests Without a Remote

You can do the length, resistance, and HDTDR tests without a remote tester. Table 5 describes the effects of a remote on tests.

- 1 Attach a coaxial adapter to the main tester.
- 2 Make sure that the home screen shows the correct settings for the job.

To make sure that other settings are correct, tap the test setup panel, make sure the correct test is selected on the **CHANGE TEST** screen, then tap **EDIT** to see more settings. Table 4 on page 68 describes the settings.

- 3 Connect the tester as shown in Figure 32.
- 4 To do an Autotest: Tap **TEST** on the main tester or press  on the main or remote tester. When the **MEASURE** button shows, tap it to do the length and resistance tests, which do not require a remote tester.

To do only the length or resistance test: On the home screen tap **TOOLS > Single Tests**, then tap a test.

To do only the HDTDR test: On the home screen tap **TOOLS > Diagnostics**, then tap **HDTDR**.

Note

*Because the tester cannot complete all tests, and the reflection at the end of the cable exceeds the 15% limit for the HDTDR test, the result for an Autotest without a remote is always **FAIL**.*

Table 5. Remote Requirements for Coaxial Tests

Test	Remote Requirements*
HDTDR analyzer	Optional. Without a remote, the plot shows large reflections at the end of the cabling.
Resistance	A remote or a terminator is required for a loop resistance measurement.
Length	Not required. Because a coaxial cable terminator eliminates signal reflections, the tester cannot measure the length of terminated cabling. The tester shows End not found in this case.
Impedance	Optional. Without a remote or terminator, the tester cannot measure the impedance of cables longer than 984 ft (300 m). The tester shows Unknown in this case.
Propagation delay	Not required. Because a coaxial cable terminator eliminates signal reflections, the tester cannot measure the propagation delay of terminated cabling. In this case, the tester shows End not found .
Insertion Loss	Required.
* If a remote is not required for a test, the test runs without activating the toner when no remote is detected.	

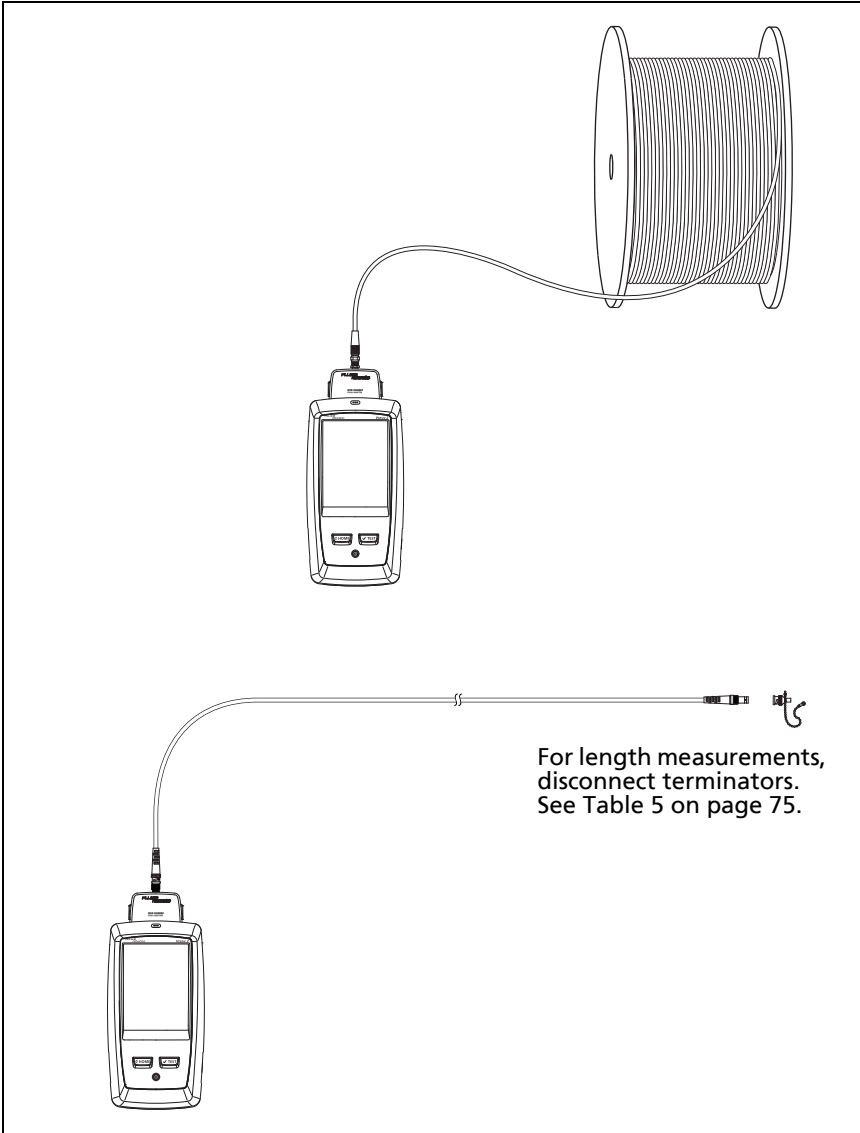

GPU183.EPS

Figure 32. Connections for Coaxial Tests Without a Remote

Continuous Tests

To do the length or resistance test continuously, go to the home screen, tap **TOOLS > Single Tests**, then tap a test.

The length and resistance tests do not compare the results to a test limit.

To save the result, tap **SCAN OFF > SAVE**. The saved test has an  for the overall result.

Chapter 4: Clean Fiber Endfaces

Always Clean Endfaces Before Tests

When a fiber optic link does not operate correctly, the cause is frequently a dirty endface in a connector. Figure 33 shows examples of dirty endfaces and an endface that has been correctly cleaned and polished.

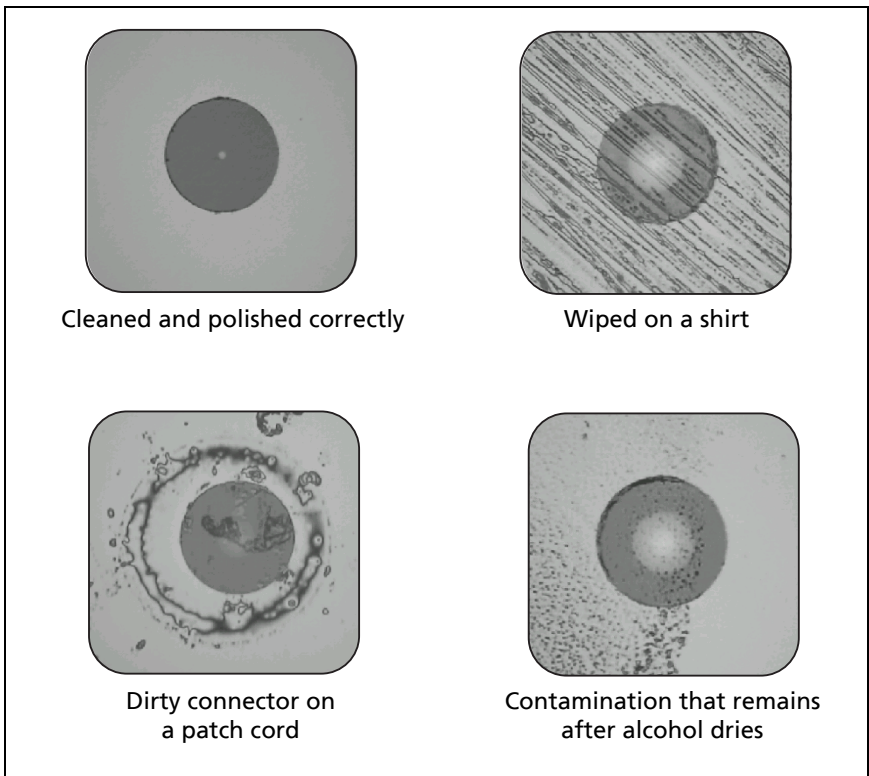

Figure 33. Examples of Clean and Dirty Fiber Endfaces

Always clean and inspect the endfaces in fiber connectors before you make connections. Fluke Networks recommends that you use a mechanical device, such as the Fluke Networks Quick Clean™ Cleaner, to clean connectors on network equipment. If you do not have such a device, if the device does not clean the connector sufficiently, or when you clean connectors on test reference cords, use other optical-grade supplies such as wipes and solvent.

Figure 34 shows the equipment you use to clean and inspect fiber endfaces.

 **Warning** 

To prevent possible eye damage caused by hazardous radiation:

- Do not look directly into optical connectors. Some optical equipment emits invisible radiation that can cause permanent damage your eyes.
- Before you clean an endface, turn off any optical sources (laser or LED) that are connected to the fiber.
- When you inspect endfaces, use only magnification devices that have the correct filters.

 **Caution**

To prevent damage to connectors and to keep contamination off of endfaces:

- Always cover unused connectors and adapters with protective caps.
- Always keep unused protective caps in a clean, sealed container to prevent contamination.

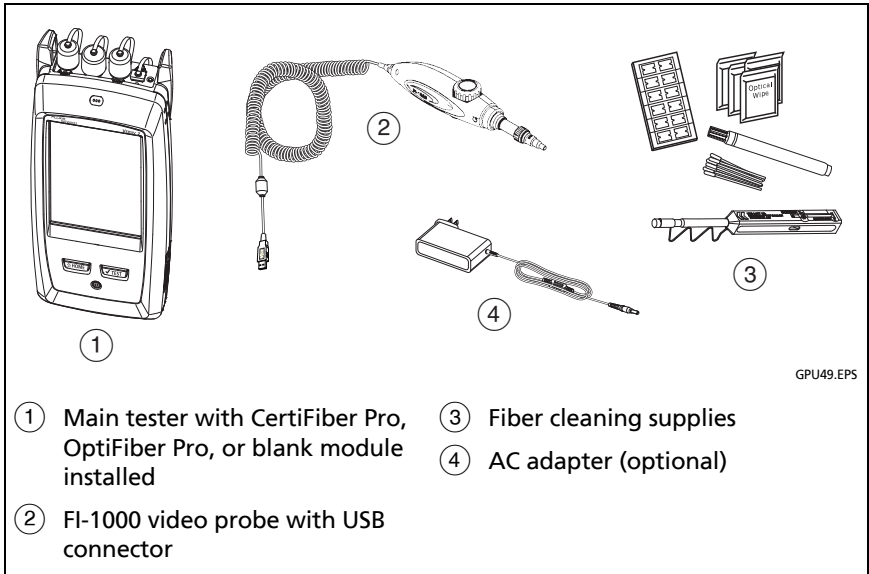

Figure 34. Equipment to Clean and Inspect Fiber Endfaces

How to Use a Fluke Networks Quick Clean Cleaner

Caution

To prevent damage to the device and to connectors and to keep contamination off of endfaces, read all instructions and obey all safety precautions given in the instructions for the device you use to clean connectors.

To clean the connectors on test reference cords, use wipes and solvent. The Quick Clean cleaner cleans the fiber core, but can leave contamination around the core. The contamination can move to the core when you make connections. See “To Clean Connector Ends” on page 85.

Note

You can use the Quick Clean cleaners to clean APC endfaces.

- 1 Use the video probe to inspect the connector. If it is dirty, continue to step 2.
- 2 To clean a bulkhead connector, remove the cap. To clean the connector on a fiber cable, remove only the tip of the cap.
- 3 If necessary for a bulkhead connector, extend the tip of the device.
- 4 Push the device straight into the connector until you hear a loud click. See Figure 35. Then remove the device.
- 5 Use the video probe to inspect the connector. If necessary, clean and inspect the connector again.

If the mechanical device does not clean the connector sufficiently, use a swab and solvent to clean the connector.

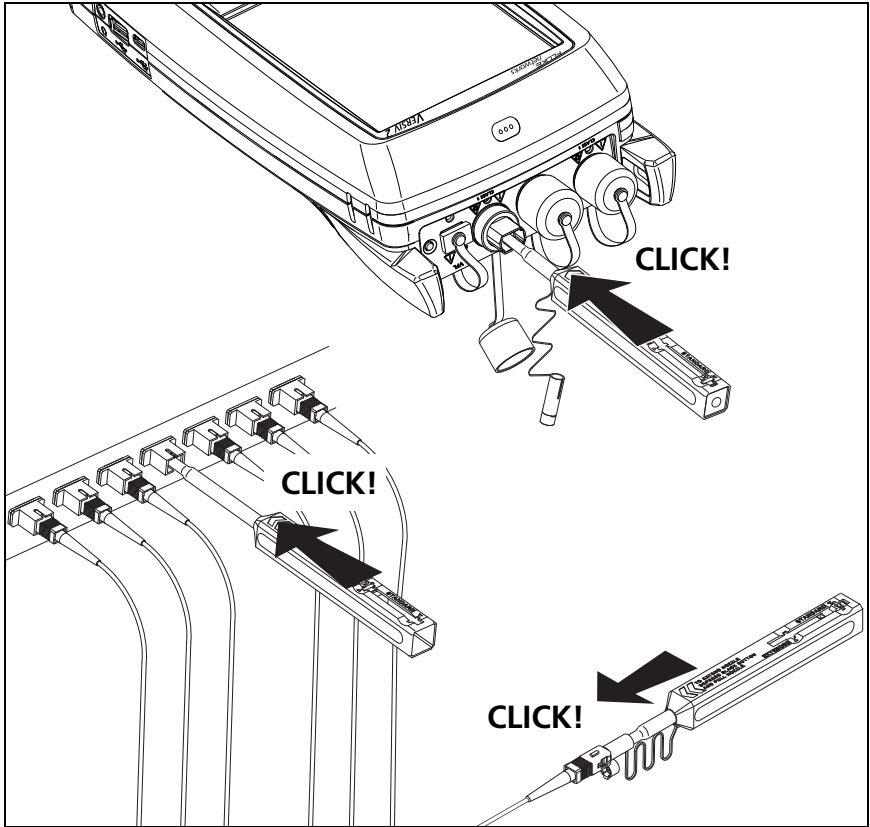

GPU16.EPS

Figure 35. How to Use the One Click Cleaner

How to Use Wipes, Swabs, and Solvent

Caution

To prevent damage to connectors and to keep contamination off of endfaces:

- Always discard wipes or swabs after you use them.
- Do not let solvent dry on an endface. Some solvents leave a residue after they dry.
- If you must use alcohol as a solvent, make sure you use 99%-pure, anhydrous alcohol.
- Put wipes on a soft surface, such as a stack of wipes, that will conform to the shape of the fiber endface.
- When you rub fiber endfaces against a dry cleaning pad, always use short strokes (~1 cm or ~0.4 in). Long strokes against a dry pad can cause a build-up of static charge that can attract dust to the endface.

To Clean Bulkhead Connectors

- 1 Use a video probe to inspect the connector. If it is dirty, continue to step 2.
- 2 Touch the tip of a fiber optic solvent pen or swab soaked in solvent to a lint-free dry wipe or fiber cleaning card.
- 3 Touch a new, dry swab to the solvent spot on the wipe or card. Push the swab into the connector, twist it around 3 to 5 times against the end-face, then remove and dispose of the swab.
- 4 Dry the connector with a dry swab by twisting it around in the connector 3 to 5 times.
- 5 Use a video probe to inspect the connector. If necessary, clean and inspect the connector again.

To Clean the Optical Connectors on the Modules

To clean the optical connectors on the modules, first use the procedure given under “To Clean Bulkhead Connectors”.

If a connector is very dirty or the procedure above does not make it clean, use this procedure:

- 1 Unscrew the adapter on the connector.
- 2 Clean the ferrule or photodiode lens with a dry, optical-grade wipe made for fiber optic connectors.
- 3 Use a video probe to inspect the connector. If necessary, clean and inspect the connector again.
- 4 If the connector stays dirty, use a wipe that is moist with optical-grade solvent to clean the endface. Dry the ferrule or lens with a dry wipe.

To Clean Fiber Adapters

At regular intervals, clean fiber adapters with a swab and fiber optic solvent. Dry with a dry swab.

To Clean Connector Ends

- 1 Use a video probe to inspect the connector. If it is dirty, continue to step 2.
- 2 Touch the tip of a fiber optic solvent pen or swab soaked in solvent to a lint-free dry wipe or fiber cleaning card.
- 3 Rub the connector end-face across the solvent spot, then back and forth once across the dry area of the wipe or card. Typically, one or two short strokes (~1 cm or ~0.4 in) are sufficient to dry the endface.
- 4 Use a video probe to inspect the connector. If necessary, clean and inspect the connector again.

Notes

For APC connectors, hold ferrule against the cleaning area at the same angle (typically 8°) as the ferrule endface.

For some connector types, such as VF-45, it is necessary to use a different method to clean the endface.

Chapter 5: Inspect Fiber Endfaces

The optional FI-1000 FiberInspector™ video probe connects to the type A USB port on the Versiv and Versiv 2 main tester to let you inspect the endfaces in fiber optic connectors. The probe lets you see dirt, scratches, and other defects that can cause unsatisfactory performance or failures in fiber optic networks.

The FI-1000 probe is included with the FI-7000 kit. The probe is an optional accessory for the CertiFiber Pro and OptiFiber Pro testers.

Connectors, Keys, and LEDs

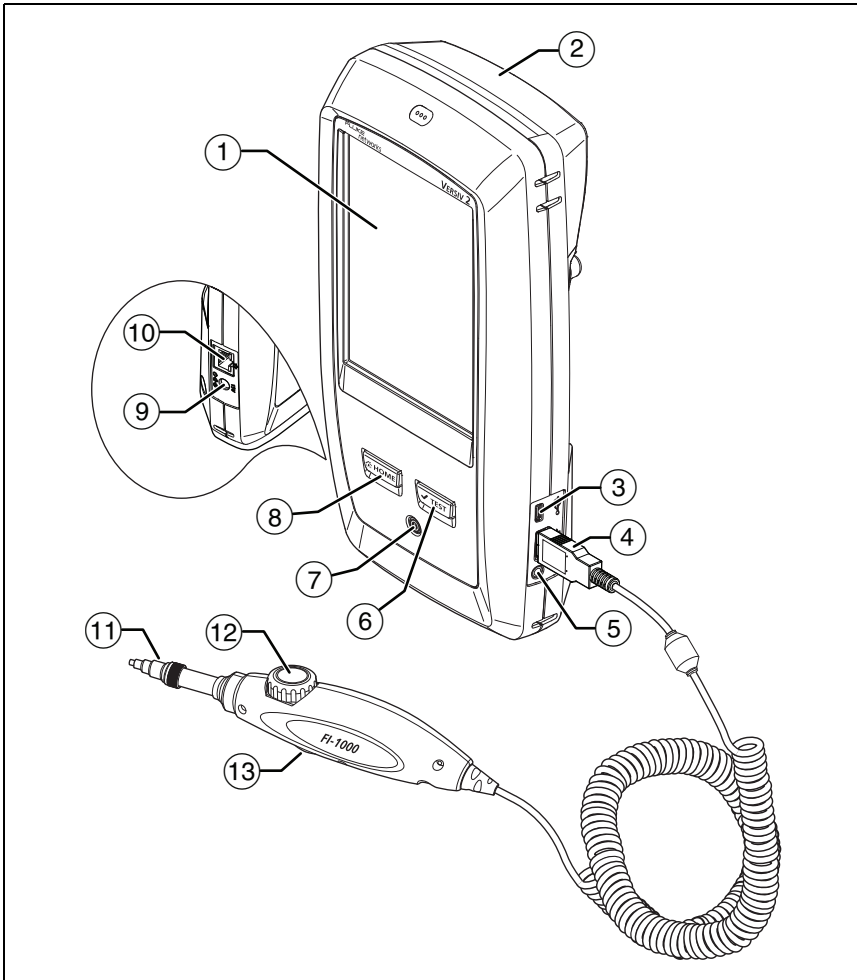



GPU173.EPS

Figure 36. Connectors, Keys, and LEDs (Versiv 2 shown)

- ① LCD display with touchscreen.
- ② Blank module included with the FI-7000 kit. Keep the module installed to give protection to the module connectors.

You can use the FiberInspector function with any module installed and with no module installed.

- ③ Micro USB port: This USB port lets you connect the tester to a PC so you can upload test results to the PC and install software updates in the tester.
- ④ Type A USB port: This USB host port lets you save test results on a USB flash drive and connect the FI-1000 video probe to the tester. On a Versiv main tester, this port lets you connect a Wi-Fi adapter for access to the Fluke Networks cloud service LinkWare Live. (Versiv 2 testers have an internal Wi-Fi radio.)
- ⑤ Headset jack.
- ⑥ : Starts a test. To start a test, you can also tap **TEST** on the display.
- ⑦ Power button. Versiv 2: The LED in the power button shows the status of the battery charging process. See Table 2 on page 13.
- ⑧ : Press  to go to the home screen.
- ⑨ Connector for the AC adapter. Versiv: The LED is red when the battery charges, and green when the battery is fully charged. The LED is yellow if the battery will not charge. See “Charge the Battery” on page 12.
- ⑩ RJ45 connector: Lets you connect to a network for access to Fluke Networks cloud services.
- ⑪ Removable tip for different types of connectors.
- ⑫ Dial for focus adjustment.
- ⑬ The button starts the FiberInspector test and switches the probe between still and live modes.

Settings for FiberInspector Tests

Table 6 gives descriptions of the settings for FiberInspector tests. To set up a project, which includes the settings in Table 6, cable IDs, and operator names, see Chapter 13.

To set up a FiberInspector test

- 1 On the home screen, tap the test setup panel.
- 2 On the **CHANGE TEST** screen, select a FiberInspector test, then tap **EDIT**.

Or to set up a new FiberInspector test, tap **NEW TEST**. If no module is installed, the **MODULE** screen shows. Tap **FiberInspector** or **FI-7000**.

- 3 On the **TEST SETUP** screen, tap the panels to change settings for the test. See Table 6.
- 4 On the **TEST SETUP** screen, tap **SAVE** when your test setup is completed.
- 5 On the **CHANGE TEST** screen, make sure the button next to the test is selected, then tap **USE SELECTED**.

Table 6. Settings for FiberInspector Tests

Setting	Description
Module	Select a CertiFiber Pro or OptiFiber Pro module or FI-7000.
Test Type	Select FiberInspector .
Test Limit	To give images a PASS or FAIL result manually, select Manual . Or, select a limit to compare scratches and defects to specific criteria for size and location. To see a different group of limits, tap MORE , then tap the name of a group. To make a custom limit, tap Custom in the Limit Groups list. See the Technical Reference Handbook.

How to Do the FiberInspector Test

Figure 37 shows the equipment for a FiberInspector test.

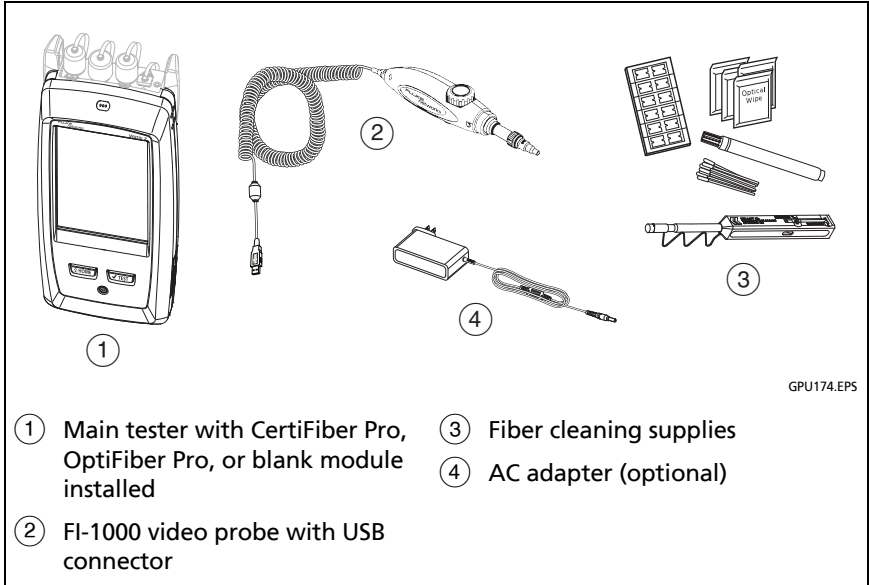



Figure 37. Equipment for the FiberInspector Test

To do the FiberInspector test

Refer to Figures 38 and 39.



- 1 Connect the FI-1000 probe to the type A USB port on the side of the tester.
- 2 Install the correct tip on the probe.
- 3 Clean the connector that you will inspect.
- 4 Use the buttons on the probe or the tester to start the test:
 - Press the button on the probe.
 - If the FiberInspector test shows on in the test setup panel on the home screen, tap **TEST** or press .

On the home screen, tap the **TOOLS** icon, then tap **FiberInspector**.

- 5 Insert the probe into the connector.
- 6 To adjust the focus, turn the dial on the probe clockwise or counterclockwise.

Figure 40 describes the FiberInspector display.

- 7 To save the image, tap **SAVE**.
- 8 On the **SAVE RESULT** screen, select **End 1** or **End 2**, make sure the **Cable ID** and **End** name are correct, then tap **SAVE**.

Saved FiberInspector results show these icons for **End 1** and **End 2**:  

Notes

*The **Auto Save** function does not operate with the FiberInspector test.*

Continuous use of the video probe decreases the battery life. To increase the battery life, connect the ac adapter when you use the probe for more than a few minutes.

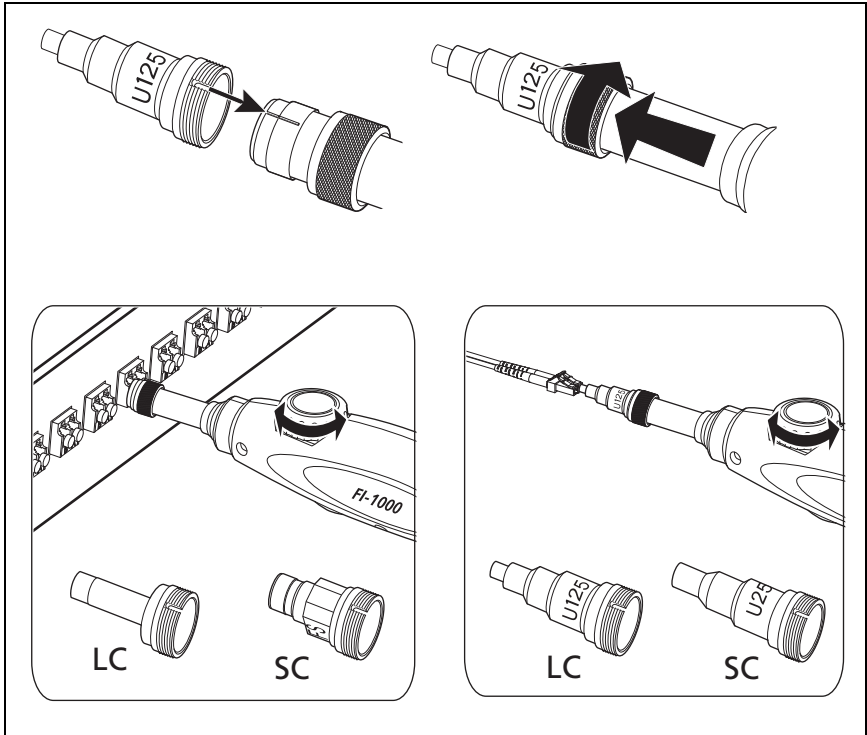

Figure 38. How to Use the FI-1000 Probe

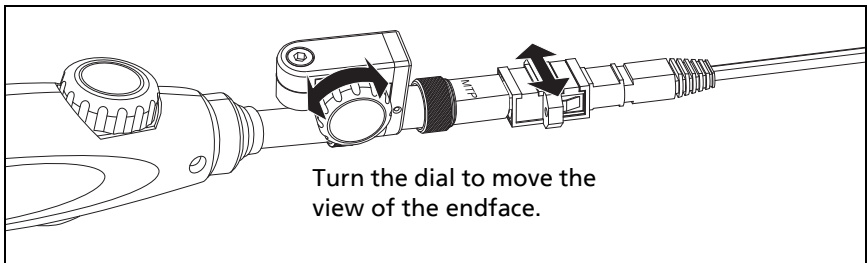
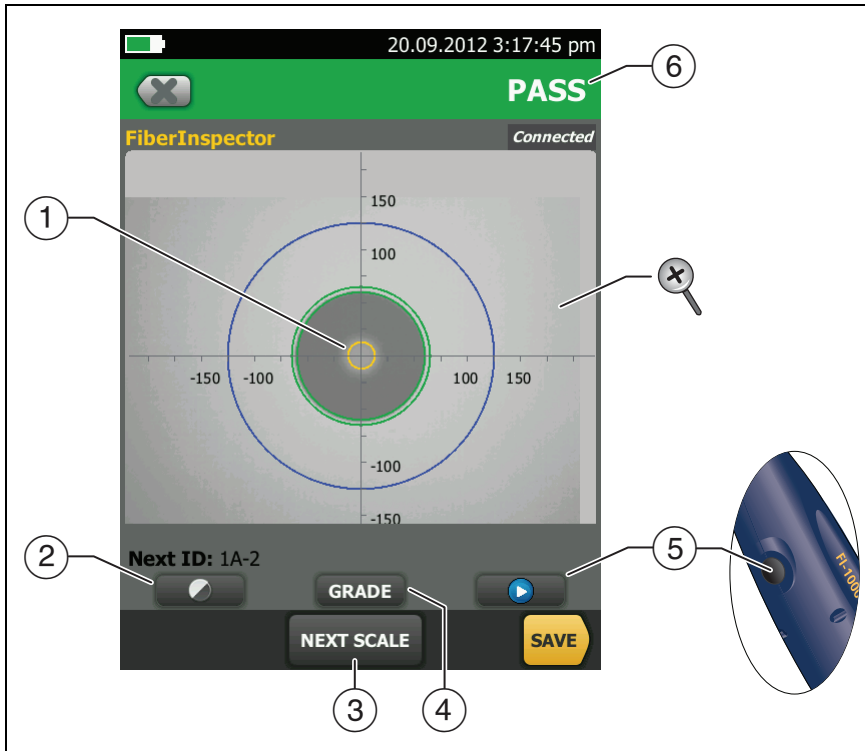



Figure 39. How to Use the Optional MPO/MTP[®] Inspection Tip



GPU25.EPS

Figure 40. FiberInspector Image with Manual Grading Selected



Note

To see the buttons for the measurement axes and core scales and to change the magnification of the screen, you must first tap  to put the screen in still mode.



- ① You can use the round, horizontal, and vertical scales to measure the size of the fiber core and cladding. You can also measure the size of particles, scratches, and other defects on the endface.

To show the scales, tap , then tap **SCALE ON** (③). Drag the image to the center of the screen if necessary.

- Outer, blue ring: 250 μm
- Middle, green rings: 120 μm and 130 μm
- Inner, yellow rings: 25 μm and 62.5 μm (to change the size, tap **NEXT SCALE**)

- ② To adjust the brightness or contrast of the image, tap , then move the bars on the controls. To hide the controls, tap  again.
- ③ To show the scales (①), tap , then tap **SCALE ON**. To change the size of the measurement ring for the fiber core, tap **NEXT SCALE**.
- ④ **Manual limit selected:** To give a **PASS** or **FAIL** grade to the image, tap **GRADE**. See ⑥.

Test limit selected: To see an analysis of the defects, tap **ANALYZE**. See “Automatic Analysis of Scratches and Defects” on page 96.

- ⑤ To put the screen in still mode and turn off the probe, press the button on the probe or tap . To turn the probe on again, press the button on the probe or tap .
- ⑥ To give the image a grade of **PASS** or **FAIL**, tap **GRADE** (④). If you set the grade to **FAIL**, then save the image, the ID for the image is in the list of tests to do again.
-  To zoom in and out, use the pinch, reverse-pinch, and double-tap gestures on the touchscreen. See Figure 3 on page 18.

Automatic Analysis of Scratches and Defects

Note

This function operates correctly only with the FI-1000 probe.

When you select a limit for the FiberInspector test, the tester can compare the size, location, and number of scratches and defects to the limit's criteria. Limits for the FiberInspector test are from standards such as IEC 61300-3-35. The limits specify the maximum size and number of scratches and defects allowed in the core, cladding, adhesive, and contact zones on the fiber endface.

To do an endface analysis

- 1 Make sure the test setup shows the correct FiberInspector test limit.
- 2 Do the FiberInspector test.
- 3 Make sure the image is in focus, then tap **ANALYZE**.

The tester highlights the scratches and defects in red or green (see Figure 41):

- Red: **FAIL**. The scratch or defect is larger than the maximum size that the limit allows, is closer to the fiber core than the limit allows, or there are more scratches or defects than the limit allows.
- Green: **PASS**. The limit allows the scratch or defect because it is too small or too far from the core to cause problems, or there are fewer than the maximum allowed number of scratches or defects of that size.

See Figure 41:

- ① A defect, such as a particle of dirt, a chip, or a pit. This defect is red because it is larger than the limit allows.
- ② The measurement rings show after you tap **ANALYZE**. The sizes of the rings are specified by the limit. To specify different sizes, make a custom endface limit. See the Technical Reference Handbook.

⚠ Caution

If a defect is possibly a dirt particle, clean the endface and do the inspection again. You must remove all loose particles because they can move into the core when you make connections.

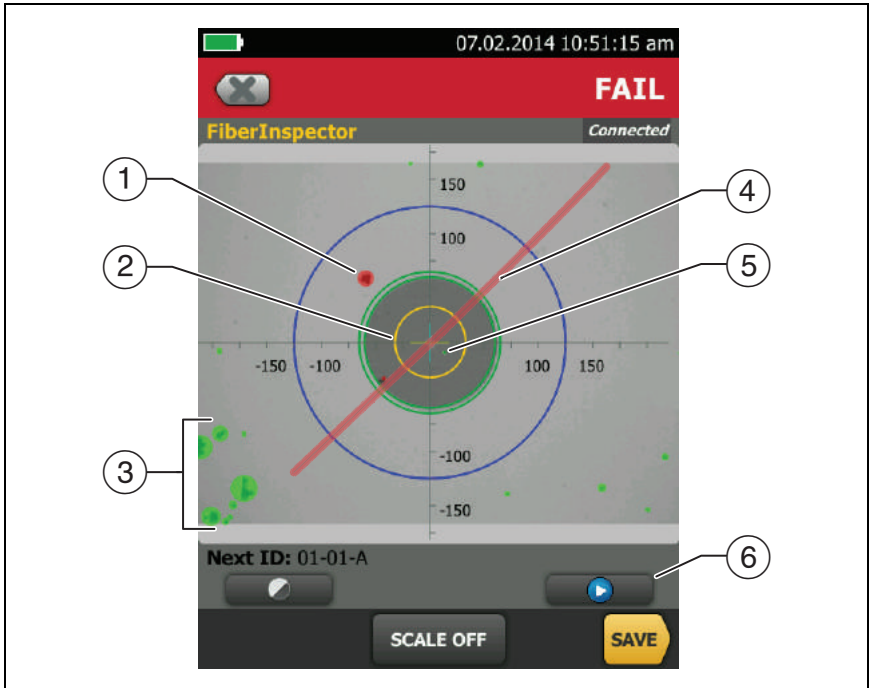

GPU167.EPS

Figure 41. FiberInspector Image with Defect Analysis

- ③ These defects are green because they are too far away from the core to cause problems.
- ④ This scratch is red because it goes through the fiber core.
- ⑤ This defect is green because the limit allows a maximum of five defects of that size or smaller in the cladding area.
- ⑥ To do the analysis again, tap  then tap **ANALYZE**.

Fiber Tests with Two Main Testers

If you have two main testers, you can use FiberInspector video probes at both ends of the cabling for faster inspections of fiber endfaces.

You can also use the second main tester as a remote tester for loss/length tests with CertiFiber Pro modules.

To use a main tester as a remote

Tap **TOOLS** then tap **Main as Remote**.

Chapter 6: Certify Fiber Cabling



Before you use the tester, read the safety information that starts on page 5.

Overview of Features

The Fluke Networks CertiFiber® Pro Optical Loss Test Set (OLTS) modules attach to Versiv™ and Versiv 2 main and remote units to make rugged, hand-held testers that let you certify, troubleshoot, and document optical fiber cabling installations. The testers include these features:

- Measures optical power loss and length on dual-fiber, multimode cabling at 850 nm and 1300 nm (CFP-MM) or on dual-fiber singlemode cabling at 1310 nm and 1550 nm (CFP-SM). The four-wavelength module (CFP-QUAD) measures at 850 nm, 1300 nm, 1310 nm, and 1550 nm.
- Interchangeable connector adapters on input and output ports let you make reference and test connections that agree with ISO standards for most SFF (small form factor) connectors.
- Visual fault locator helps you find breaks, bad splices, and bends and verify fiber continuity and polarity.
- Optional FiberInspector™ video probe lets you inspect fiber endfaces and save the images in test reports.

Connectors, Keys, and LEDs

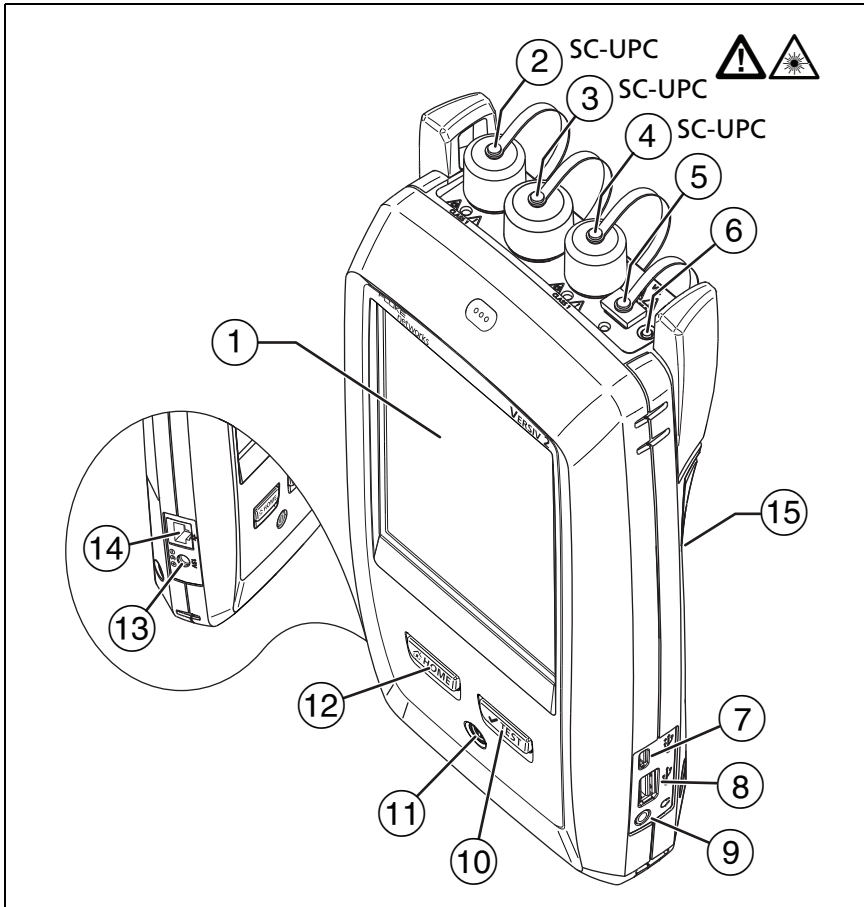

GPU123.EPS

**Figure 42. Main Tester Connectors, Keys, and LEDs
(Versiv 2 with CFP-QUAD module shown)**

- ① LCD display with touchscreen
- ② Singlemode output port with removable connector adapter and dust cap. This port transmits optical signals for loss and length measurements.



The LED below the output port is red when the port transmits 1310 nm and green for 1550 nm.



 **Caution**

Do not connect APC (angled physical contact) connectors to the output ports. Doing so can damage the port's UPC endface and cause unreliable test results.

- ③ Input port with removable connector adapter and dust cap. This port receives optical signals for loss, length, and power measurements.
- ④ Multimode output port with removable connector adapter and dust cap. This port transmits optical signals for loss and length measurements.

The LED below the output port is red when the port transmits 850 nm and green for 1300 nm.

- ⑤ Universal fiber connector (with dust cap) for the visual fault locator. The connector accepts 2.5 mm ferrules. The LED below the connector shows the locator's mode.
- ⑥ Button to manually control the output ports (② and ④) and the visual fault locator (⑤).
- ⑦ Micro USB port: This USB port lets you connect the tester to a PC so you can upload test results to the PC and install software updates in the tester.
- ⑧ Type A USB port: This USB host port lets you save test results on a USB flash drive and connect the FI-1000 video probe to the tester. On a Versiv main tester, this port lets you or connect a Wi-Fi adapter for access to the Fluke Networks cloud service LinkWare Live. (Versiv 2 testers have an internal Wi-Fi radio.)
- ⑨ Headset jack
- ⑩  TEST: Starts a test. To start a test, you can also tap **TEST** on the display.
- ⑪ : Power button. Versiv 2: The LED in the power button shows the status of the battery charging process. See Table 2 on page 13.

- ⑫ : Press  to go to the home screen.
- ⑬ Connector for the AC adapter. Versiv: The LED is red when the battery charges, and green when the battery is fully charged. The LED is yellow if the battery will not charge. See “Charge the Battery” on page 12.
- ⑭ RJ45 connector: Lets you connect to a network for access to Fluke Networks cloud services.
- ⑮ Decal with laser safety information.



λ = 650nm, 0.05mW IEC/EN 60825-1 Complies with 21 CFR 1040.10 and 1040.11
except for deviations pursuant to Laser Notice 50, dated June 24, 2007

See Figure 43:

- ① **PASS** LED comes on when a test passes.
TEST LED comes on during a test and when you manually turn on one of the output ports (⑥).
FAIL LED comes on when a test fails.
TALK LED comes on when the talk function is on. The LED flashes until the main tester accepts the request to talk.
TONE LED flashes if you press  when a main tester is not connected to the remote or is in **Far End Source** mode.
LOW BATTERY LED comes on when the battery is low.
The LEDs also have these functions:
 - Battery gauge (see Figure 1 on page 14)
 - Volume indicator for the **TALK** function
 - Progress indicator for software updates
- ② Singlemode output port with removable connector adapter and dust cap. This port transmits optical signals for loss and length measurements.
The LED below the output port is red when the port transmits 1310 nm and green for 1550 nm.

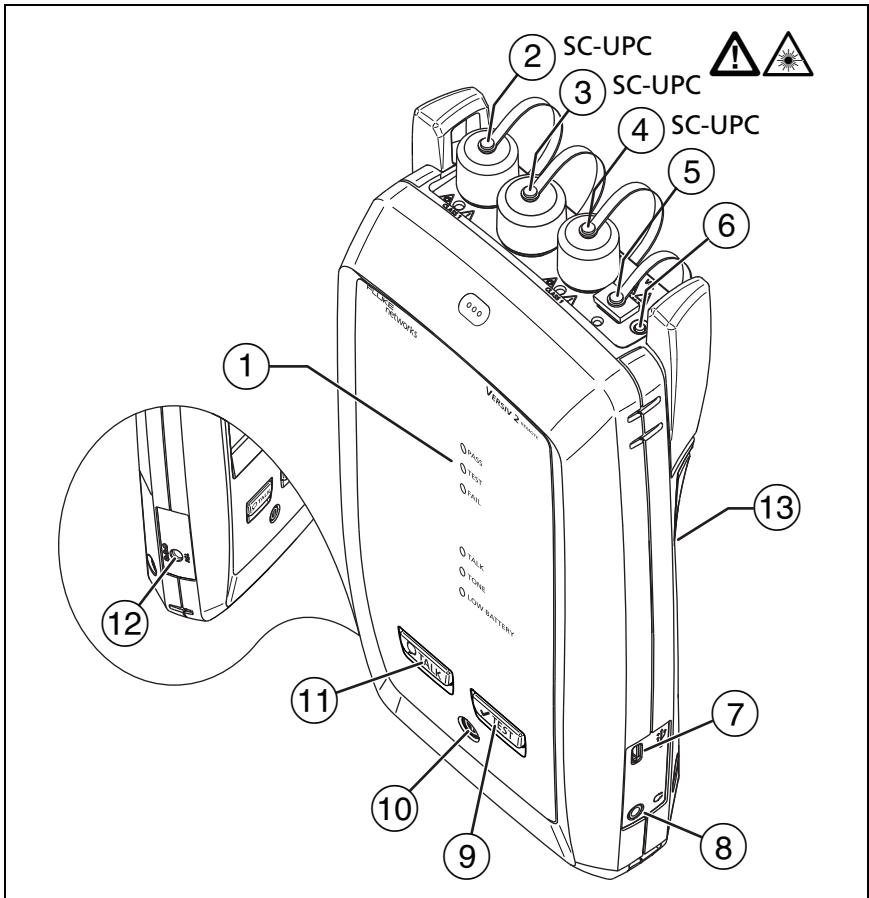

GPU136.EPS

Figure 43. Remote Tester Connectors, Keys, and LEDs
(Versiv 2 with CFP-QUAD module shown)

⚠ Caution

Do not connect APC (angled physical contact) connectors to the output ports. Doing so can damage the port's UPC endface and cause unreliable test results.

- ③ Input port with removable connector adapter and dust cap. This port receives optical signals for loss, length, and power measurements.
- ④ Multimode output port with removable connector adapter and dust cap. This port transmits optical signals for loss and length measurements.

The LED below the output port is red when the port transmits 850 nm and green for 1300 nm.

- ⑤ Universal fiber connector (with dust cap) for the visual fault locator. The connector accepts 2.5 mm ferrules. The LED below the connector shows the locator's mode.
- ⑥ Button to manually control the output ports (② and ④) and the visual fault locator (⑤).
- ⑦ Micro USB port: This USB port lets you connect the tester to a PC so you can install software updates in the tester.
- ⑧ Headset jack
- ⑨ **✓TEST**: Starts a test.
- ⑩ **Ⓞ**: Power key
- ⑪ **☞TALK**: Press **☞TALK** to use the headset to speak to the person at the other end of the link. Press again to adjust the volume. To turn off the talk function, hold down **☞TALK**.
- ⑫ Connector for the AC adapter. The LED is red when the battery charges, and green when the battery is fully charged. The LED is yellow if the battery will not charge. See "Charge the Battery" on page 12.
- ⑬ Decal with laser safety information.



$\lambda = 650\text{nm}$, 0.85mW IEC/EN 60825-1 Complies with 21 CFR 1040.10 and 1040.11 except for deviations pursuant to Laser Notice 50, dated June 24, 2007

How to Remove and Install the Connector Adapters

You can change the connector adapters on the input ports of the modules to connect to SC, ST, LC, and FC fiber connectors. You can remove the adapter on the output port to clean the fiber endface in the port. See Figure 44.

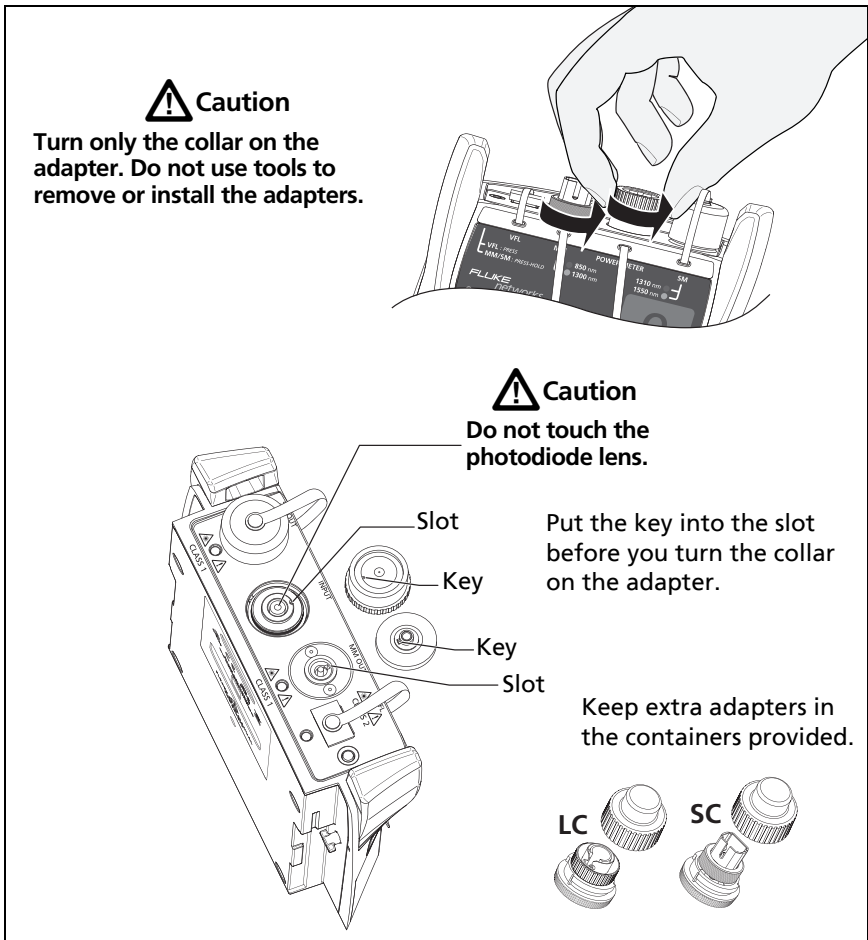

GPU135.EPS

Figure 44. How to Remove and Install the Connector Adapters

The CertiFiber Pro Home Screen

The home screen (Figure 45) shows important test settings. Before you do a test, make sure these settings are correct.

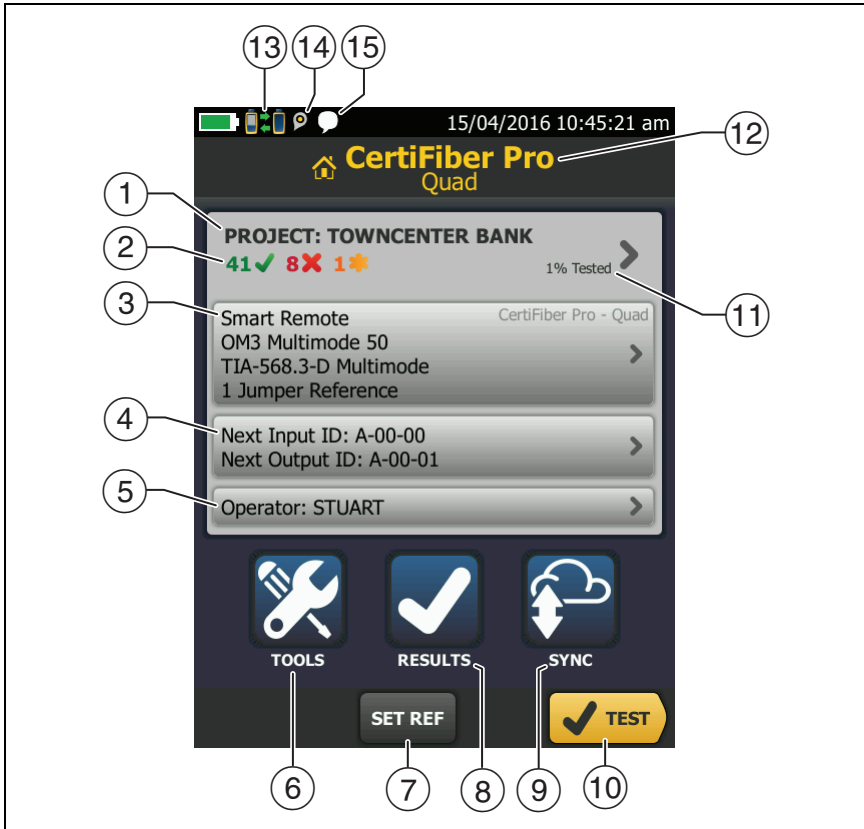

GPU117.EPS

Figure 45. The Home Screen for CertiFiber Pro Modules

- ① **PROJECT:** The project contains the settings for a job and helps you monitor the status of a job. When you save test results, the tester puts them in the project. Tap the **PROJECT** panel to edit the project settings, select a different project, or make a new project.

- ② Shows a summary of the test results in the project:
- ✓ The number of tests that passed.
 - ✗ The number of tests that failed.
- ③ The test setup panel shows the settings the tester will use when you tap **TEST** or press .

To change these settings, tap the panel, select the test on the **CHANGE TEST** screen, tap **EDIT**, select different settings on the **TEST SETUP** screen, then tap **SAVE**. See Table 7 on pages 117 and 118.



Note

You can set up tests for any module that the tester can use, even when no module is attached.

- ④ **Next ID:** The **Next ID** panel shows the ID that the tester gives to the next test results you save. For **Smart Remote** mode, this panel shows IDs for main tester's input and output fibers.
- Tap **Next ID** to do these tasks:
- Enter an ID, select a different ID in the ID set, select a different set of IDs, or make a new set. The tester adds the IDs and ID sets you make to the project that shows on the home screen.
 - Turn **Auto Save** on or off.
- ⑤ **Operator:** The name of the person who does the job. You can enter a maximum of 20 operator names. For each operator you can also enter the email address that the operator will use as an ID to sign in to LinkWare Live.
- ⑥ **TOOLS:** The **TOOLS** menu lets you set the reference for fiber tests, see the status of the tester, and set user preferences such as the language and the display brightness.
- ⑦ **SET REF:** Tap **SET REF** to set the reference and verify your test reference cords for loss/length tests.

- ⑧ **RESULTS:** Tap **RESULTS** to see and manage the results that are saved in the tester.
- ⑨ **SYNC:** Tap **SYNC** to sync projects with LinkWare Live.
- ⑩ **TEST:** Tap **TEST** to do the test shown in the test setup panel.
- ⑪ **% Tested:** The percentage of the tests in the project that are completed. The tester uses the number of available IDs to calculate this percentage. See Figure 118 on page 298.

% Tested does not show if your project contains only a **Next ID** list. See “About Next ID Sets” on page 297 for more information about the **Next ID** list.

- ⑫ The type of module attached to the tester.
- ⑬  This icon shows when the input and output ports on the tester’s CertiFiber Pro module are connected to the ports on the remote’s CertiFiber Pro module, the remote tester is turned on, and **Smart Remote** or **Loopback** mode is selected.
- ⑭  The asset management icon shows when the owner of a LinkWare Live account has enabled the asset management service on the tester. “About the Asset Management Service” on page 309.
- ⑮  This icon shows when the talk function is on. To use the talk function:

- 1 Connect the main and remote testers together through a duplex fiber link.
- 2 Connect headsets to the headset jacks on the testers.
- 3 Press the button on one of the headset microphones or press  on the remote, then speak into the microphone.

Requirements for Reliable Fiber Test Results

To get reliable fiber test results and make sure your tester meets its accuracy specifications, you must use the correct procedures:

- Use proper cleaning procedures to clean all fiber connectors before every use. See Chapter 4.
- Set the reference frequently. See “About the Reference for Fiber Tests” on page 110.
- Use only test reference cords that comply with ISO/IEC 14763-3. Measure the loss of the cords frequently. See “About Test Reference Cords and Mandrels” on page 112.
- For multimode fiber, make sure you use the encircled flux test reference cords (EF-TRCs) or standard mandrels correctly. See “About the EF-TRC (Encircled-Flux Test Reference Cords)” on page 112 and “TRCs Necessary for Links with APC Connectors” on page 115.
- Keep the tester’s software current. The latest software is available on the Fluke Networks website. See “Update the Software” on page 315.
- Make sure you select the correct fiber type and test limit for the job, and the index of refraction for the fiber is correct. See Table 7 on page 117.
- Make sure the battery is fully charged.
- Send the modules to a Fluke Networks service center every 12 months for factory calibration.

About the Reference for Fiber Tests

The reference procedure for fiber cable sets a baseline power level for loss measurements. If the power level that enters the fiber from the source changes, the reference and your loss measurements will be incorrect. The power level can change, for example, when the temperature at the job site increases or decreases or when you disconnect then reconnect a test reference cord at the tester's output port. So, it is important to set the reference frequently.

When to Set the Reference

Note

At the job site, turn on the testers and let them sit for a minimum of 5 minutes before you set the reference. Let them sit longer if they are above or below ambient temperature.

The tester requires you to set the reference at these times:

- When you change the CertiFiber Pro module in the main or remote tester.
- When you use a different remote tester.
- When you change the **Reference Method** in the test setup.

Set the reference also at these times:

- At the start of each day, at the job site, then at regular intervals during the day. For example, set the reference when you start tests on a different series of fibers.
- When you connect a test reference cord to the module's output port or to another source, even if you connect the same test reference cord you connected before.
- When the tester tells you that the reference is out of date.
- When a loss measurement is negative. This occurs when there was a problem when you set the reference. For example, an endface was dirty or the testers were cold.

 **Caution**

Do not disconnect the test reference cords from the modules' output ports after you set the reference. If you do, you will change the amount of optical power that enters the fiber and the reference will not be correct.

Good Reference Values

For **Smart Remote** and **Loopback** modes, these are the typical ranges for reference values:

- Multimode 50/125 μm fiber: -19.4 dBm to -26.5 dBm
- Multimode 62.5/125 μm fiber: -17.5 dBm to -23.0 dBm
- Singlemode fiber: -1.0 dBm to -6.0 dBm

For **Far End Source** mode with a CertiFiber Pro source, reference values must be in these ranges:

- Multimode 50/125 μm fiber: -19.4 dBm to -26.5 dBm
- Multimode 62.5/125 μm fiber: -17.5 dBm to -23.0 dBm
- Singlemode fiber: -1.0 dBm to -9.7 dBm

If your reference value is outside of the applicable range given above, clean and inspect all connectors then set the reference again. Do this even if the tester lets you use the value.

If your test reference cords and connectors are in good condition, and you use the correct procedure to set the reference, the reference value will not change by more than approximately 0.4 dBm.

How to See the Reference Values

- After you set the reference, tap **View Reference** on the **SET REFERENCE** screen.
- After you do an Autotest, tap the result window for a fiber, then tap **VIEW REFERENCE**.

About Test Reference Cords and Mandrels

Use only test reference cords (TRCs) that have low loss:

- **Maximum loss for multimode TRCs:** ≤ 0.15 dB
- **Maximum loss for singlemode TRCs:** ≤ 0.25 dB

To make sure your test results are accurate as possible:

- Inspect the endfaces of the TRCs every 24 to 48 tests and clean them when necessary.
- Use the **TRC VERIFICATION** wizard available for the **1 Jumper** and **3 Jumper** reference methods to measure the losses of the TRCs. The losses of the TRCs are included in the loss measurements for links, so you must make sure the losses are very small. The wizard saves the results of the TRC tests to show that your TRCs were good. IDs for these results start with "TRC", show the date and time of the test, and have an  for the test result.

About the EF-TRC (Encircled-Flux Test Reference Cords)

The CFP-MM and CFP-QUAD kits includes the EF-TRC (encircled flux test reference cords), which have signal conditioners on the cords. When you use the EF-TRCs with the CertiFiber Pro multimode modules, your tester complies with IEC 61280-4-1, ISO/IEC 14763-3, and TIA-526-14-B standards for encircled flux. Measurements made with compliant equipment change less than 10 % for losses of 1 dB or more when you make them at different times or with different equipment that is also compliant.

Note

The IEC 61280-4-1, ISO/IEC 14763-3, and TIA-526-14-B standards require your optical loss test set to comply with encircled flux standards at 850 nm with 50 μ m/125 μ m fiber. The standards recommend compliance at 850 nm with 62.5 μ m/125 μ m fiber and at 1300 nm with 50 μ m/125 μ m and 62.5 μ m/125 μ m fiber.

 **Caution**

To prevent damage to fiber connectors, to prevent data loss, and to make sure that your test results are as accurate as possible:

- Use the EF-TRC cords only with the CertiFiber Pro modules or with sources approved by Fluke Networks for use with the cords. If a source does not have the correct LED and internal fibers, the EF-TRC cords will not make launch conditions that agree with encircled flux standards.
- When you use the EF-TRCs, DO NOT use other mandrels.
- Always follow the handling guidelines given in Figure 46.
- Put protective caps on all connectors when you do not use them.
- Use EF-TRCs that have the fiber core dimension (50 μm or 62.5 μm) and type of connectors (SC, ST, LC, or FC) that are the same as the fiber link. Do not use EF-TRCs with hybrid patch cords to connect to links that have other types of connectors.

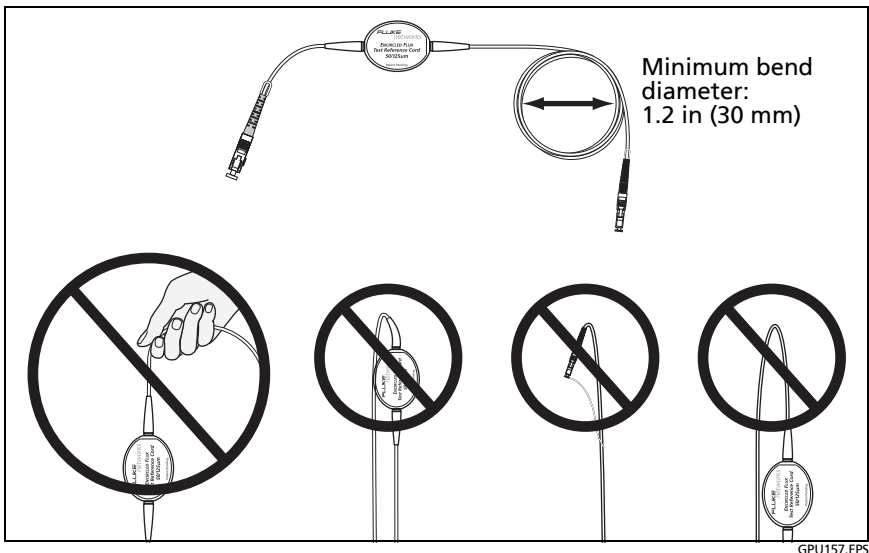

GPU157.EPS

Figure 46. How to Prevent Damage to the EF-TRC Fiber Cables

About APC Connectors

When you do tests on links with APC (angled physical contact) connectors, use only test reference cords with APC connectors on the ends connected to the link. If you connect non-APC connectors to the link, the connectors will cause large reflections that make loss measurements inaccurate.

For tests on links with APC connectors, use test reference cords that also have APC connectors on the ends connected to the tester's input ports. This is necessary for the 1 jumper reference method. You can connect APC connectors to the tester's input ports because the fiber does not touch the lens on the input port.

Caution

Do not connect APC connectors to the output ports. Doing so can damage the port's UPC endface and cause unreliable test results.

Figure 47 shows the TRCs necessary for tests on links with APC connectors.

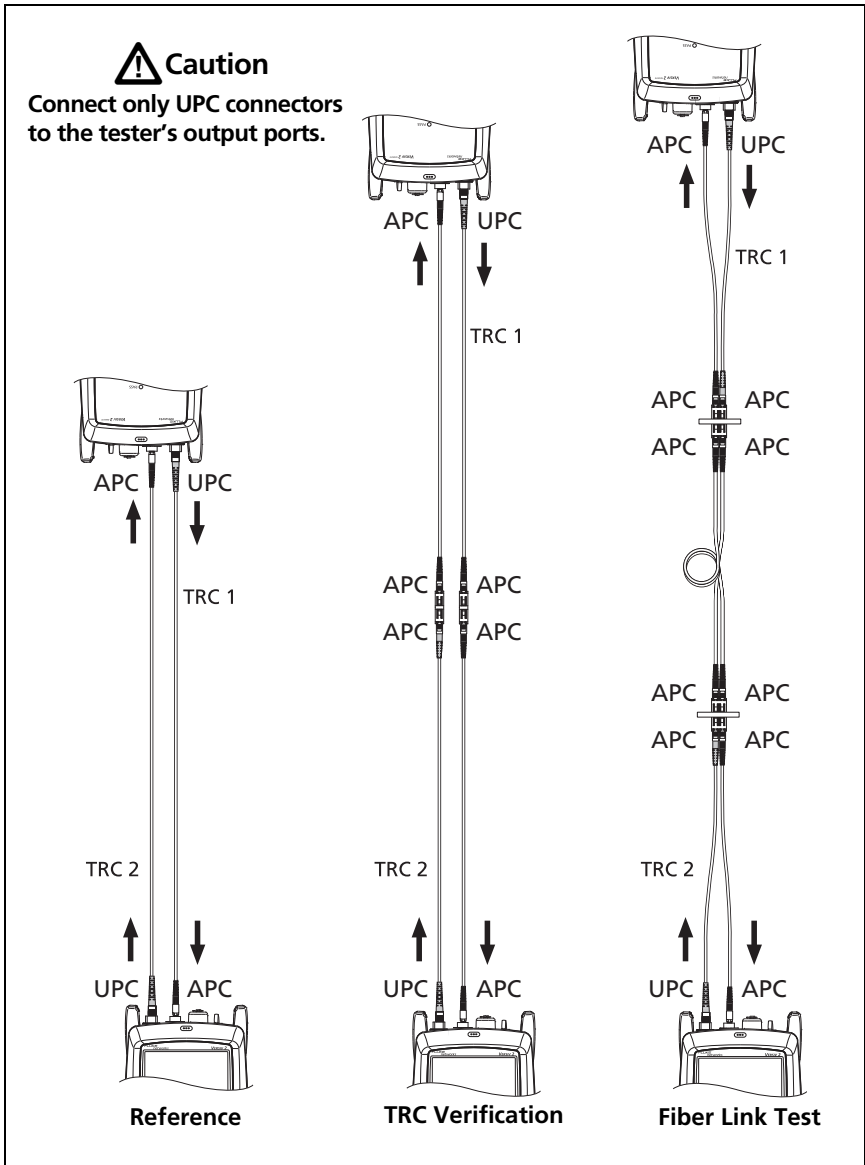

GPU166.EPS

Figure 47. TRCs Necessary for Links with APC Connectors

About Standard Mandrels

Standard mandrels make measurements of multimode power loss more reliable than if you use no mandrels, but the measurements do not comply with the standards for encircled flux. Fluke Networks recommends that you always use only the EF-TRCs with the CertiFiber Pro multimode modules so that your measurements comply with EF standards.

If you must do tests in Far End Source mode with a different multimode source, and the source is not approved by Fluke Networks for use with the TRCs, use standard mandrels. Make sure you use the size of mandrel that is correct for 50 μm or 62.5 μm fiber, and read all instructions for the source and mandrel.

Caution

If you use mandrels for tests on multimode fiber, do not use test reference cords made from bend-insensitive fiber. The mandrels possibly will not remove all of the modes that can make your loss measurements unreliable.

Settings for Fiber Tests

Table 7 gives descriptions of the settings for fiber tests. To set up a project, which includes the settings in Table 7, cable IDs, and operator names, see Chapter 13.

To set up a fiber test

- 1 On the home screen, tap the test setup panel.
- 2 On the **CHANGE TEST** screen, select a fiber test to change, then tap **EDIT**.

Or to set up a new fiber test, tap **NEW TEST**. If no module is installed, the **MODULE** screen shows. Tap the correct CertiFiber Pro module.

- 3 On the **TEST SETUP** screen, tap the panels to change settings for the test. See Table 7.
- 4 On the **TEST SETUP** screen, tap **SAVE** when your test setup is completed.
- 5 On the **CHANGE TEST** screen, make sure the button next to the test is selected, then tap **USE SELECTED**.

Table 7. Settings for Fiber Tests

Setting	Description
Module	Select the CertiFiber Pro module you will use.
Test Type	Use Smart Remote mode for tests on duplex-fiber cabling. See page 124. Use Loopback mode for tests on patch cords and cable spools. See page 132. Use Far End Source mode for tests on individual fibers. See page 140.
Bi-directional	Off: The tester does fiber tests in only one direction. On: The tester does fiber tests in both directions. See “Bi-directional Tests” on page 149. The Bi-directional setting is not available for Far End Source mode.
Fiber Type	Select a fiber type that is correct for the type you will test. To see a different group of fiber types, tap MORE , then tap a group. To make a custom fiber type, tap Custom in the Fiber Groups list. See the Technical Reference Handbook.
Fiber Type Settings	IOR: The tester uses the index of refraction to calculate the optical length of the fiber. Each fiber type includes the value specified by the manufacturer. To use a different IOR , make a custom fiber type. See the Technical Reference Handbook.

-continued-

Table 7. Settings for Fiber Tests (continued)

<p>Test Limit</p>	<p>Select the correct test limit for the job. To see a different group of limits, tap MORE, then tap the name of a group. To make a custom limit, tap Custom in the Limit Groups list. See the Technical Reference Handbook.</p>
<p>Reference Method</p>	<p>On the No. of Connectors/Splices screen, set the number of jumpers you will use in each fiber path when you set the reference. The dotted lines in the diagram on the screen show you which parts of the link are included in the test results.</p> <p>The number of jumpers you use has these effects on loss measurements:</p> <p>1 Jumper: Loss measurements include the connections at both ends of the link. The figures in this manual show 1 Jumper connections.</p> <p>2 Jumper: Loss measurements include one connection at one end of the link.</p> <p>3 Jumper: Loss measurements do not include the connections at the ends of the link. The tester measures only the loss of the fiber.</p> <p>This setting does not change the loss measurements, but it can change the PASS/FAIL result for test limits that use a calculated loss limit. For all test limits, the tester saves this setting to show the reference method you used.</p> <p style="text-align: center;"> Caution</p> <p>Most cable manufacturers will give you a warranty on a fiber installation only if you use the 1 Jumper reference method when you certify the installation.</p> <p style="text-align: center;"><i>Note</i></p> <p><i>Different standards use different names for the three methods. See Appendix A.</i></p>

Table 7. Settings for Fiber Tests (continued)

<p>Connector Type</p>	<p>Select the type of connector, such as SC or LC, used in the cabling.</p> <p>The tester uses this setting when you do bi-directional tests. If you select a connector that has a threaded or bayonet coupler, such as FC or ST, the tester waits for you to confirm that the connection is complete before it starts the second part of the test. If you select a quick-release connector, such as SC or LC, the tester automatically starts the test when you connect the fiber.</p> <p>The tester also saves this setting to record the type of connector you used. This setting does not change your test results or any of the diagrams that the tester shows. If the correct type is not in the list, select General.</p>
<p>No. of Connectors/ Splices</p>	<p>The Total Connections and Splices settings are applicable only if the selected test limit uses a calculated limit for loss.</p> <p>Total Connections: Enter the total number of connections that are in each path of the link. Do not adjust the number for the Reference Method you use. For example, if the link has 3 connections, enter "3" even if you use the 2 or 3 Jumper reference method. When the tester calculates the loss limit, it automatically removes the losses of the connections you used to set the reference.</p> <p style="text-align: center;"><i>Note</i></p> <p style="text-align: center;"><i>The CertiFiber Pro automatically adjusts the number of connections for the Reference Method you use. This is different from the DTX CableAnalyzer, where you do not include the reference connections in the number of connectors.</i></p> <p>Splices: Enter the number of splices in each path of the link.</p> <p style="text-align: right;">-continued-</p>

Table 7. Settings for Fiber Tests (continued)

<p>No. of Connectors/ Splices (continued)</p>	<p>Jumper Reference: Enter the number of jumpers you will use in each fiber path when you set the reference. The dotted lines in the diagram on the screen show you which parts of the link are included in the test results. See Reference Method above.</p> <p>Figure 48 shows the No. of Connectors/Splices screen.</p> <p>Figure 49 shows how to count the jumpers, connectors, and splices for this setting.</p>
<p>TRC LENGTH (Test reference cord length)</p>	<p>You can enter length of your test reference cords when you set the reference. To enter this value, tap TRC LENGTH on the SET REFERENCE screen. The length you enter does not change the test results. The tester saves the length with the results to meet TIA reporting requirements.</p>

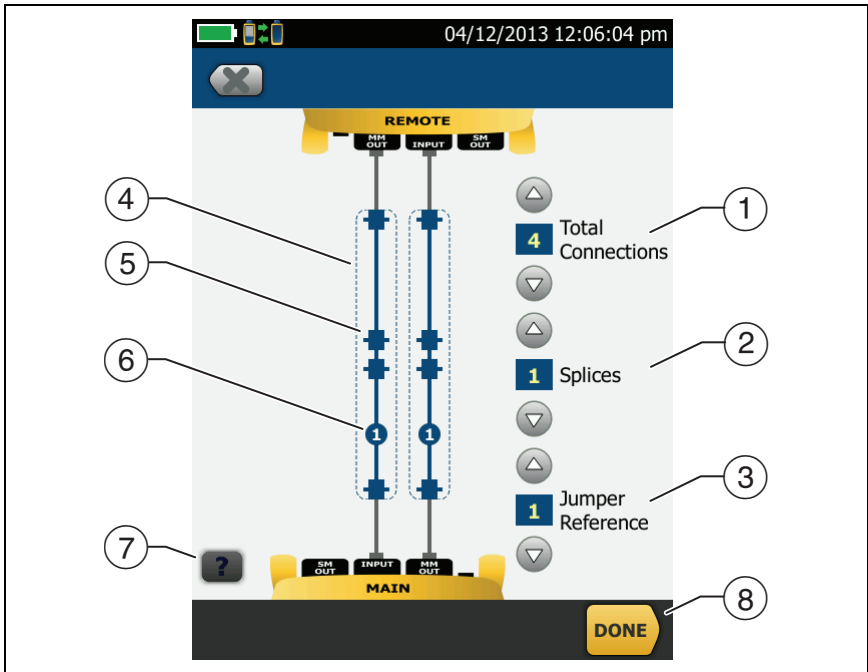



GPU140.EPS

Figure 48. Screen to Set the Number of Connectors, Splices, and Jumpers

- ① **Total Connections:** Enter the total number of connections that are in each path of the link. Do not adjust the number for the **Reference Method** you use. For example, if the link has 3 connections, enter “3” even if you use the **2** or **3 Jumper** reference method. When the tester calculates the loss limit, it automatically removes the losses of the connections you used to set the reference.

Note

For links with MPO modules, each module is one connector.

- ② **Splices:** Enter the number of splices that are in each path of the link.
- ③ **Jumper Reference:** Enter the number of jumpers you will use in each fiber path when you set the reference. The dotted lines in the diagram on the screen show you which parts of the link are included in the test results. See **Reference Method** on page 118.
- ④ The dotted lines show you which parts of the link are included in the test results.
- ⑤ Connector icons show the connections between the ends of the link. If you enter 7 or more for the **Total Connections** setting, a number inside of a connector icon shows the number of connectors between the ends of the link. For example, if the **Total Connections** setting is 7, a connector icon shows the number 5 ()
- ⑥ The round icon shows the number of splices in each path of the link.
- ⑦ To see help for the screen, tap .
- ⑧ To save your settings, tap **DONE**.

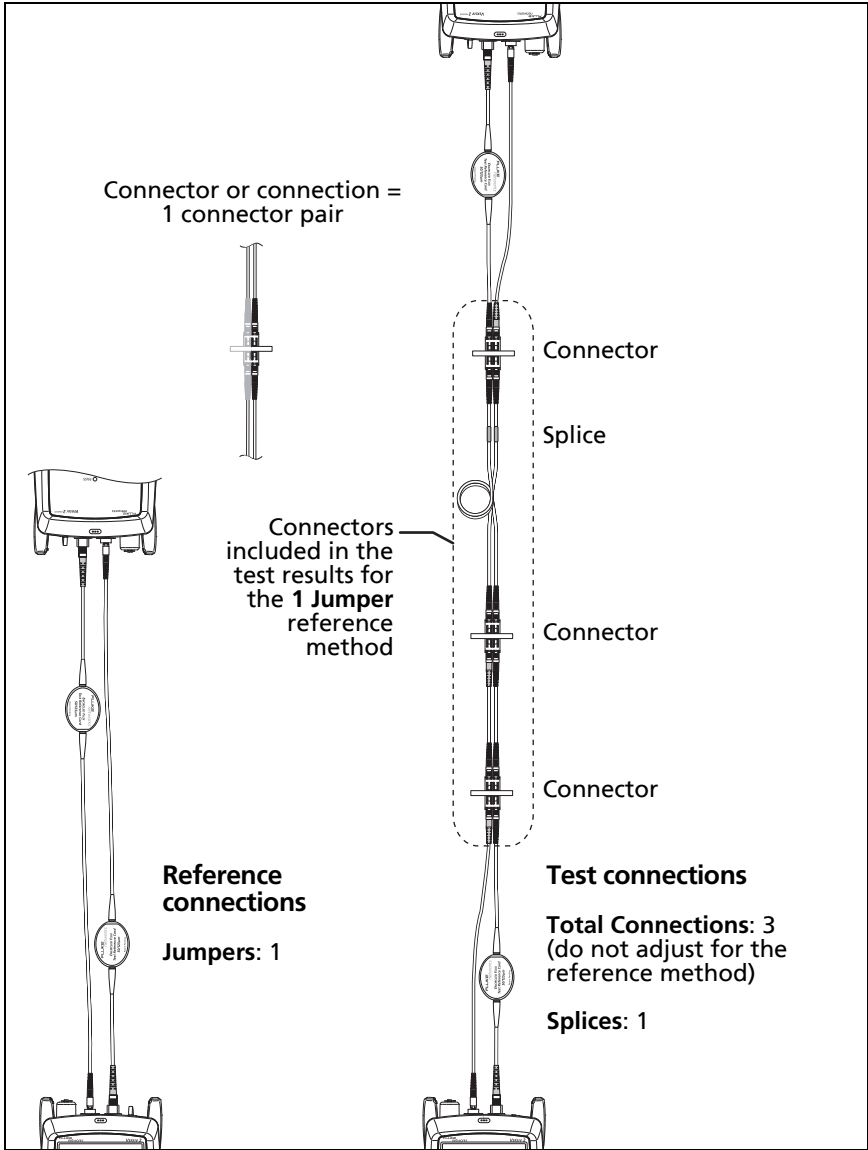

Figure 49. How to Count the Numbers of Connectors, Splices, and Jumpers

About 1 Jumper Reference Connections

The reference and test connections shown in this manual give 1 jumper results. 1 jumper results include the loss of the fiber plus the loss of the connections at both ends of the link. This is the best method for tests on premises fiber installations. Premises installations typically use patch cords at both ends of the link, and connector loss is a large part of the total loss.

If you do not have the correct connector adapters, see Appendix B for other connections that give 1 jumper results.

For descriptions of the 2 and 3 jumper reference connections, see the *Versiv Series Technical Reference Handbook*.

Caution

Most cable manufacturers will give you a warranty on a fiber installation only if you use a 1 Jumper reference when you certify the installation.

Note

If you use a 2 Jumper reference, the Wizard for the reference procedure does not show steps for the TRC verification. To save test results for the TRCs, do the tests manually.

Autotest in Smart Remote Mode

Use **Smart Remote** mode to do tests on dual-fiber cabling.

In this mode, the tester measures loss and length on two fibers at two wavelengths. If you turn on the **Bi-Directional** function and swap the fibers halfway through the test, the tester makes measurements in both directions.

Figure 50 shows the equipment for tests in **Smart Remote** mode.

Fiber Tests with Two Main Testers

If you have two main testers, you can use one as a remote tester for tests in Smart Remote mode. This also lets you use FiberInspector video probes at both ends of the cabling for faster inspections of fiber endfaces.

To use a main tester as a remote

Tap **TOOLS** then tap **Main as Remote**.

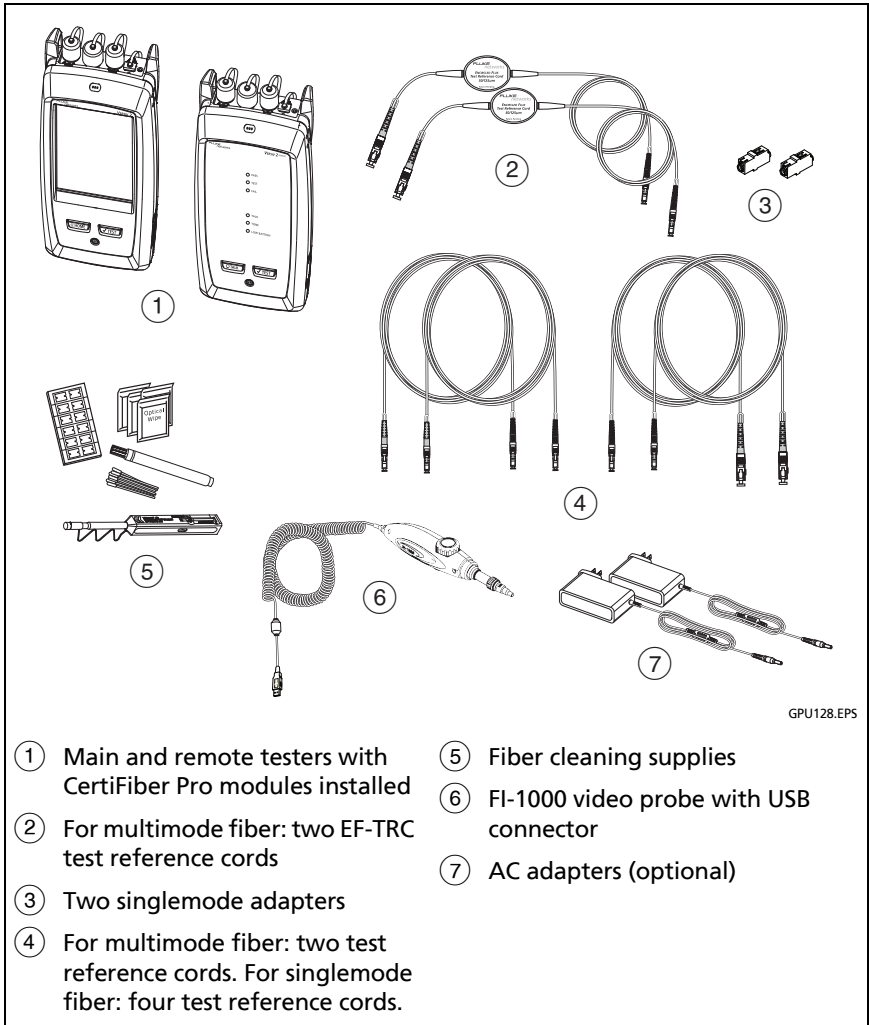

Figure 50. Equipment for Autotests in Smart Remote Mode

Step 1: Set the Reference in Smart Remote Mode

- 1-1 Turn on the tester and remote and let them sit for a minimum of 5 minutes. Let them sit longer if they are above or below ambient temperature.
- 1-2 Make sure that the home screen shows the correct settings for the job, and the test type is **Smart Remote**.

To make sure that other settings are correct, tap the test setup panel, make sure the correct test is selected on the **CHANGE TEST** screen, then tap **EDIT** to see more settings. Table 7 on page 117 describes the settings.

- 1-3 Clean and inspect the connectors on the tester, remote, and test reference cords.
- 1-4 On the home screen tap **SET REF**.
- 1-5 On the **SET REFERENCE** screen, tap **RUN WIZARD**.

Notes

*To only set the reference, and not measure the loss of your test reference cords, tap **SKIP WIZARD** on the **SET REFERENCE** screen.*

Fluke Networks recommends that you measure the loss of your test reference cords each time you set the reference.

- 1-6 Make the connections to set the reference, as shown on the screen and in Figure 51, then tap **NEXT** to see the completed connections.

Notes

*The **SET REFERENCE** screen shows reference connections for the selected reference method. Figure 51 shows connections for a **1 Jumper** reference.*

When you set the reference, align the testers as shown in Figure 51 to keep the fibers as straight as possible.

-continued-

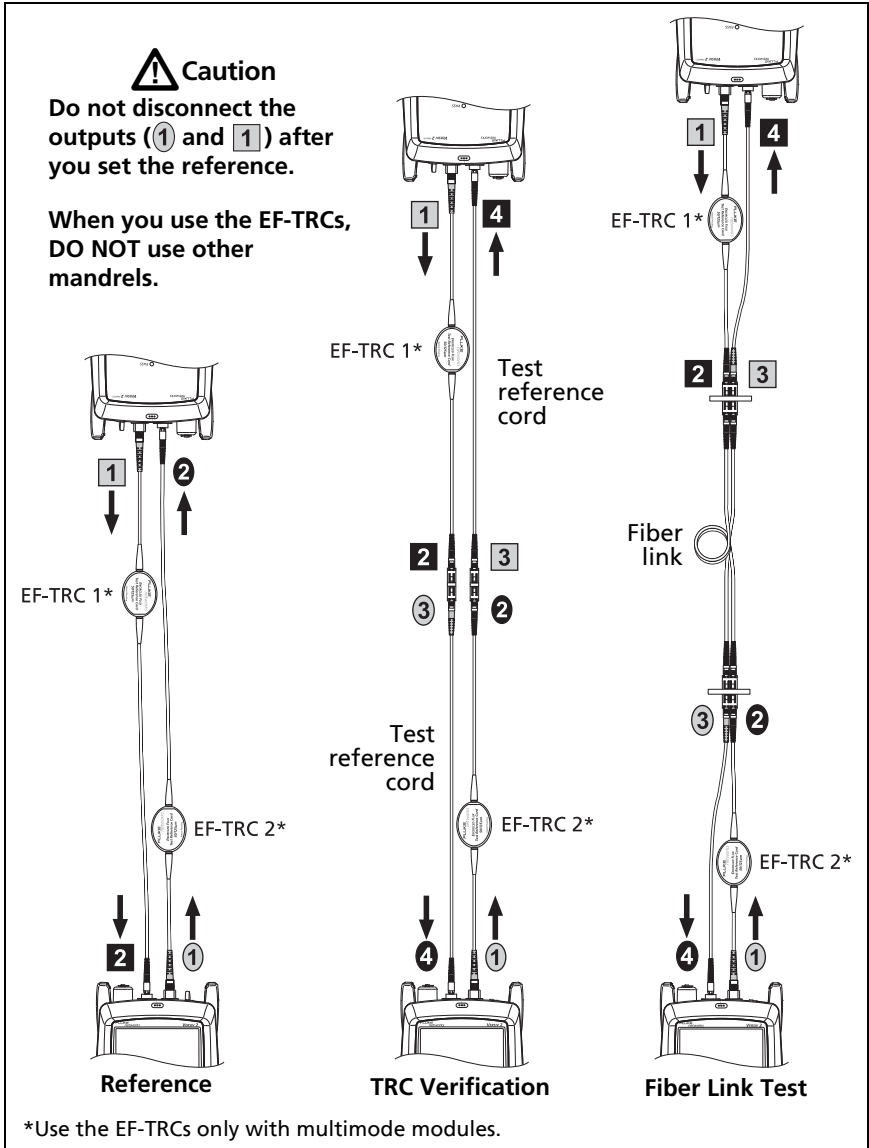

GPU122.EPS

**Figure 51. Connections for Smart Remote Mode
(1 Jumper Reference, Multimode Fiber)**

1-7 To enter the length of the test reference cords you will add to connect to the link, tap **TRC LENGTH** on the **SET REFERENCE** screen. The length you enter does not change the test results. The tester saves the length with the results to meet TIA reporting requirements.

1-8 Tap **SET REFERENCE**.

If reference values are unacceptable, you can use the FiberInspector probe to inspect connectors. To turn on the probe, press the button on the probe. To go back to the reference screen, tap  .

1-9 If you did not use the connection wizard, go to step 3.

Step 2: Measure the Loss of the Test Reference Cord You Will Add

Caution

If you disconnected a test reference cord from the output of the tester or remote, you must set the reference again to make sure your measurements are reliable.

2-1 On the **SET REFERENCE** screen, when the reference procedure is completed, tap **NEXT**.

2-2 Disconnect the test reference cords from the INPUT ports on the tester and remote, then use test reference cords and adapters to make the connections to verify the TRCs, as shown on the screen and in Figure 51.

2-3 Tap **TRC VERIFICATION**. The tester measures and saves the loss of the test reference cords you added. The IDs for these results start with "TRC", show the date and time of the test, and have an  for the test result.

The tester shows a warning if the loss of a TRC is more than these limits:

- **Maximum loss for multimode TRCs:** 0.15 dB
- **Maximum loss for singlemode TRCs:** 0.25 dB

If the tester shows a warning, clean and inspect the connectors on the TRCs in the path that has too much loss, make sure the cords are straight as shown in Figure 51, then do the TRC verification again.

Step 3: Do an Autotest in Smart Remote Mode



If you disconnected a test reference cord from the output of the tester or remote, you must set the reference again to make sure your measurements are reliable.

- 3-1 On the **SET REFERENCE** screen, when the set reference or TRC verification procedure is completed, tap **NEXT** to see how to connect to the link under test.
- 3-2 Clean and inspect all the connectors.
- 3-3 Make the connections to do the test on the fiber link, as shown on the screen and in Figure 51, then tap **HOME**.
- 3-4 Tap **TEST** on the main tester or press  on the main or remote tester.

If the **CHECK FIBER CONNECTIONS** screen shows an open fiber:

- Make sure that all connections are good and no fibers have damage. Use the VFL to make sure the fibers in the link have continuity.
- Make sure that the remote is on.
- Switch the connections at one end of the patch panel.

-continued-

- If you are not sure you are connected to the correct fibers, connect the main tester's INPUT fiber to different connections until the test continues or the INPUT fiber on the display is green. Then if necessary, connect the remote's INPUT fiber to different connections until the test continues.
- 3-5** If **Bi-directional** is **On**: Halfway through the test, the tester tells you to switch the input and output fibers. See "Bi-directional Tests" on page 149.
- 3-6** Save the result:
- If **Auto Save** is on, the tester uses the next two IDs to save the results for the two fibers.
 - If **Auto Save** is off, tap **SAVE** if the test passed or **FIX LATER** if the test failed. The **SAVE RESULT** screen shows the next two IDs available. You can change the IDs if necessary.

Autotest Results for Smart Remote Mode

Unsaved results show the results for both fibers. See Figure 52.

- ① The overall result for the Autotest.
- ② The fiber IDs and the loss and length measurements for the fibers:

 The result exceeds the limit.

 The result is within the limit.

 The selected test limit does not have a limit for the test.

To see the results, limits, and margins for a fiber, tap the window.

- ③ The settings the tester used for the test.

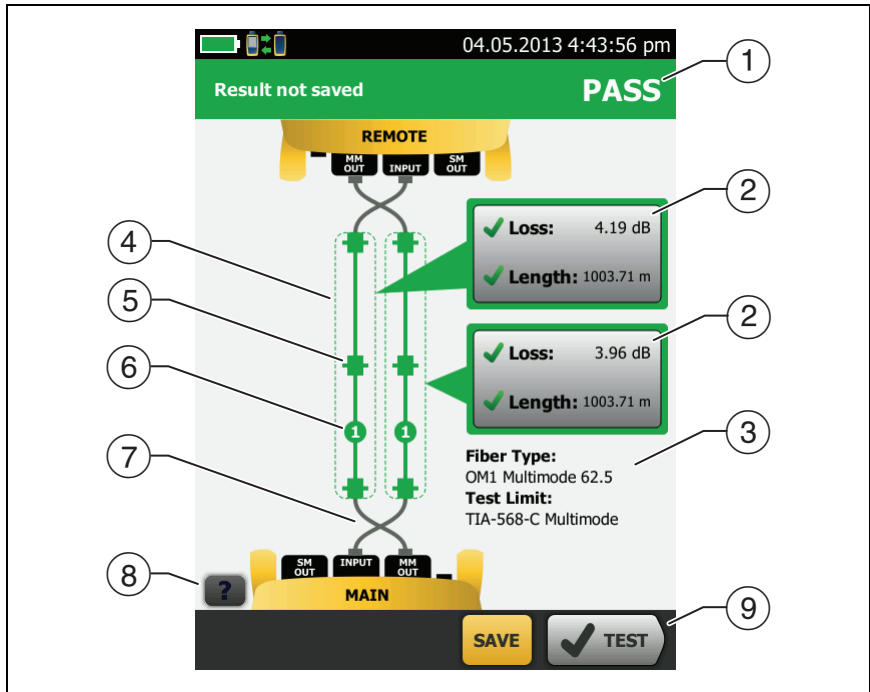

GPU118.EPS

Figure 52. Result for Smart Remote Mode
(Unsaved Bi-Directional Results Shown)

Note

The length shown for each fiber is half of the total length of both fibers.

- ④ The dashed lines are around the connectors and fiber that are included in the loss and length results. Gray connectors and fibers are not included because you used them to set the reference.
- ⑤ Connector icons show the number you entered for the **TOTAL CONNECTIONS** setting on the **No. of Connectors/Splices** screen (Figure 48 on page 120). For Figure 52, the **TOTAL CONNECTIONS** setting is 4.

- ⑥ The round icon shows the number of splices entered for the **SPLICES** setting on the **No. of Connectors/Splices** screen.
- ⑦ Bi-directional results show the fibers crossed at the main and remote ports. The fibers show the connections as they are at the end of the test.
- ⑧ To see help for the screen, tap .
- ⑨ When more than one button shows at the bottom of the screen, the tester highlights one in yellow to recommend which one to tap. See “Buttons to Do Tests and Save Results” on page 19.

Fiber IDs for Saved Results in Smart Remote Mode

If **Auto Save** is **On** and the test passed, the tester saves two records, one for each fiber. The records have the next two IDs in the ID list.

If you must change the ID for a fiber before you save results, set **Auto Save** to **Off** before you do the test. Then, on the **SAVE RESULT** screen, tap the **Input Fiber ID** or **Output Fiber ID** window.

Autotest in Loopback Mode

Use **Loopback** mode to do tests on spools of cable and segments of uninstalled cable.

In this mode, the tester measures loss and length at two wavelengths. If you turn on the **Bi-directional** function and swap the fibers halfway through the test, the tester makes measurements in both directions.

Figure 50 shows the equipment for tests in Loopback Mode.

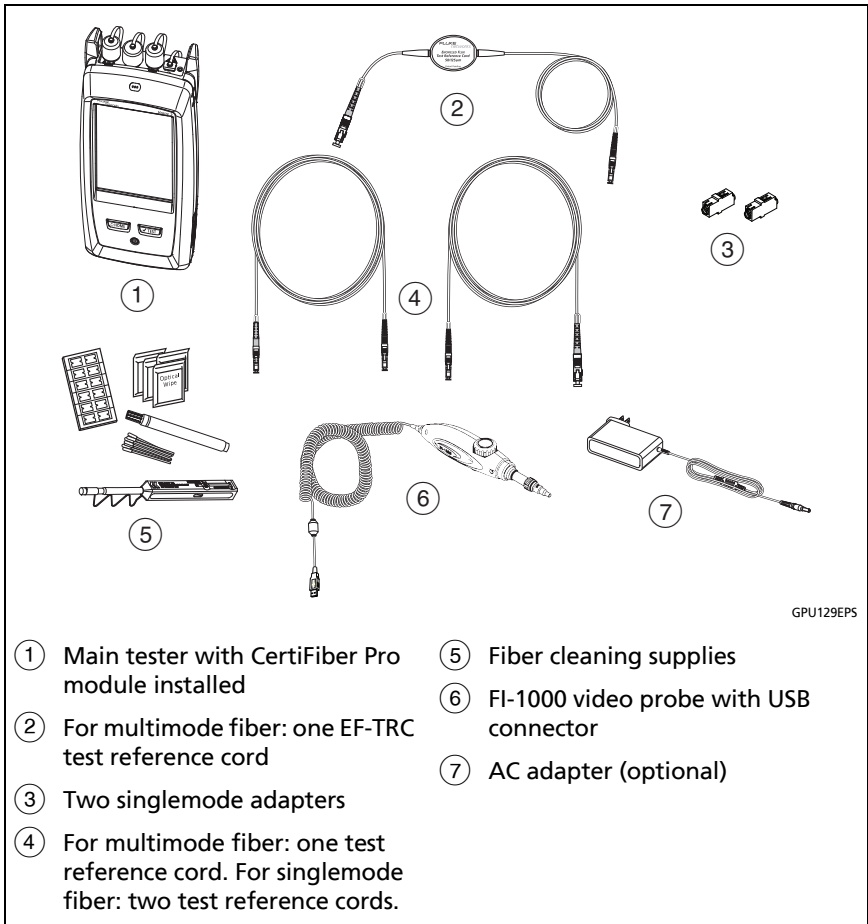

Figure 53. Equipment for Autotests in Loopback Mode

Step 1: Set the Reference in Loopback Mode

1-1 Turn on the tester and let it sit for a minimum of 5 minutes. Let it sit longer if it is above or below ambient temperature.

1-2 Make sure that the home screen shows the correct settings for the job, and the test type is **Loopback**.

To make sure that other settings are correct, tap the test setup panel, make sure the correct test is selected on the **CHANGE TEST** screen, then tap **EDIT** to see more settings. Table 7 on page 117 describes the settings.

1-3 Clean and inspect the connectors on the tester and test reference cords.

1-4 On the home screen tap **SET REF**.

1-5 On the **SET REFERENCE** screen, tap **RUN WIZARD**.

Notes

*To only set the reference, and not measure the loss of your test reference cord, tap **SKIP WIZARD** on the **SET REFERENCE** screen.*

Fluke Networks recommends that you measure the loss of your test reference cord each time you set the reference.

1-6 Make the connection to set the reference, as shown on the screen, then tap **NEXT** to see the completed connections. Figure 54 also shows the completed connections.

Notes

*The **SET REFERENCE** screen shows reference connections for the selected reference method. Figure 54 shows connections for the **1 Jumper** reference.*

When you set the reference, keep the fiber as straight as possible.

-continued-

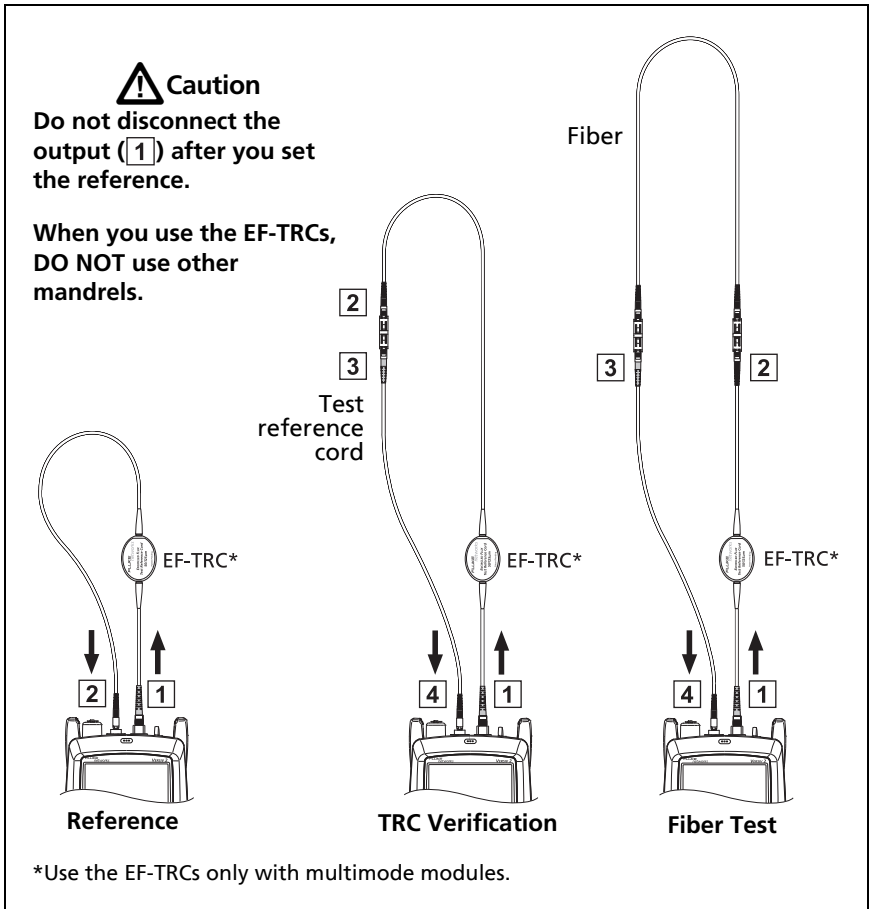

GPU131.EPS

Figure 54. Connections for Loopback Mode
(1 Jumper Reference, Multimode Fiber)

- 1-7 To enter the length of the test reference cord you will add to connect to the fiber under test, tap **TRC LENGTH** on the **SET REFERENCE** screen. The length you enter does not change the test results. The tester saves the length with the results to meet TIA reporting requirements.
- 1-8 Tap **SET REFERENCE**.
- If reference values are unacceptable, you can use the FiberInspector probe to inspect connectors. To turn on the probe, press the button on the probe. To go back to the reference screen, tap .
- 1-9 If you did not use the connection wizard, go to step 3.

Step 2: Measure the Loss of the Test Reference Cord You Will Add

Caution

If you disconnected the test reference cord from the output of the tester, you must set the reference again to make sure your measurements are reliable.

- 2-1 On the **SET REFERENCE** screen, when the reference procedure is completed, tap **NEXT**.
- 2-2 Disconnect the test reference cord from the **INPUT** port on the tester, then use a test reference cord and adapter to make the connections to verify the TRCs, as shown on the screen and in Figure 54.
- 2-3 Tap **TRC VERIFICATION**. The tester measures and saves the loss of the test reference cord you added. The ID for this result starts with "TRC", shows the date and time of the test, and has an  for the test result.

The tester shows a warning if the loss of a TRC is more than these limits:

- **Maximum loss for multimode TRCs: 0.15 dB**

- **Maximum loss for singlemode TRCs: 0.25 dB**

If the tester shows a warning, clean and inspect the connectors on the TRC, make sure the cords do not have tight bends, as shown in Figure 54, then do the TRC verification again.

Step 3: Do an Autotest in Loopback Mode



If you disconnected the test reference cord from the output of the tester, you must set the reference again to make sure your measurements are reliable.

- 3-1 On the **SET REFERENCE** screen, when the set reference or TRC verification procedure is completed, tap **NEXT** to see how to connect to the fiber under test.
- 3-2 Clean and inspect the connectors on the fiber under test.
- 3-3 Make the connections to do the test on the fiber, as shown on the screen and in Figure 54, then tap **HOME**.
- 3-4 Tap **TEST** on the main tester or press  on the main or remote tester.

If the **CHECK FIBER CONNECTIONS** screen shows an open fiber:

- Make sure that all connections are good and no fibers have damage. Use the VFL to make sure the fiber under test has continuity.
- If you are connected to fibers at a patch panel that are connected together at the far end, and you are not sure you are connected to the correct fibers, connect the main tester's INPUT fiber to different connections until the test continues.

-continued-

3-5 If **Bi-directional** is **On**: Halfway through the test, the tester tells you to switch the input and output fibers. See “Bi-directional Tests” on page 149.

3-6 If **Auto Save** is on, the tester uses the next ID to save the results.

If **Auto Save** is off, the **SAVE RESULT** screen shows the next ID available. You can change the ID if necessary.

Autotest Results for Loopback Mode

Figure 55 shows an example of Autotest results for Loopback mode.

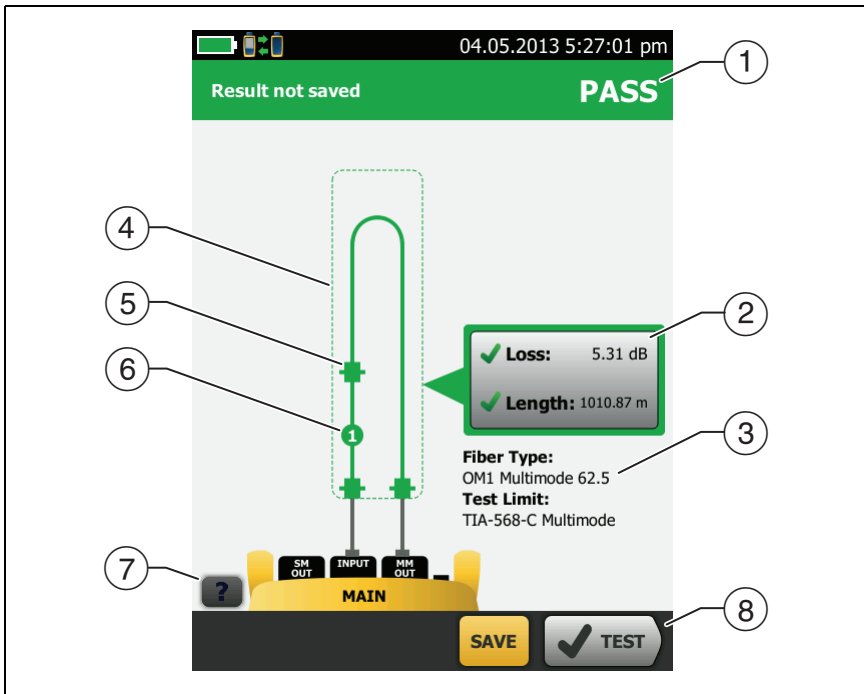





Figure 55. Result for Loopback Mode

GPU119.EPS

- ① The overall result for the Autotest.
- ② The loss and length measurements for the fiber:
 -  The result exceeds the limit.
 -  The result is within the limit.
 -  The selected test limit does not have a limit for the test.
To see the results, limits, and margins for the fiber, tap the window.
- ③ The settings the tester used for the test.
- ④ The dashed lines are around the connectors and fiber that are included in the loss and length results. Gray connectors and fibers are not included because you used them to set the reference.
- ⑤ Connector icons show the number you entered for the **TOTAL CONNECTIONS** setting on the **No. of Connectors/Splices** screen (Figure 48 on page 120). For Figure 55, the **TOTAL CONNECTIONS** setting is 3.
- ⑥ The round icon shows the number of splices entered for the **SPLICES** setting on the **No. of Connectors/Splices** screen.
- ⑦ To see help for the screen, tap .
- ⑧ When more than one button shows at the bottom of the screen, the tester highlights one in yellow to recommend which one to tap. See “Buttons to Do Tests and Save Results” on page 19.

Autotest in Far End Source Mode

Use **Far End Source** mode to measure loss at two wavelengths on one fiber.

In this mode, you can use the CertiFiber Pro remote or another source, such as the Fluke Networks SimpliFiber® Pro source, at the far end of the fiber.

Caution

For Far End Source mode, use the EF-TRC cords only with the CertiFiber Pro modules or with sources approved by Fluke Networks for use with the cords. If a source does not have the correct LED and internal fibers, the EF-TRC cords will not make launch conditions that comply with encircled flux standards. If the source is not approved, use a standard mandrel.

Figure 56 shows the equipment for tests in Far End Source mode.

Auto Wavelength Modes

CertiFiber Pro modules and SimpliFiber Pro sources have an auto wavelength mode. In this mode, the output port transmits both wavelengths (850 nm and 1300 nm or 1310 nm and 1550 nm). The signal includes identifiers that tell the meter when to measure power at each wavelength. The CertiFiber Pro module in the remote always operates in auto wavelength mode.

To select **Auto CertiFiber Pro** or **Auto SimpliFiber Pro** mode, you tap the setting when the tester shows the **TEST MODE** window. The **TEST MODE** window shows each time you set the reference.

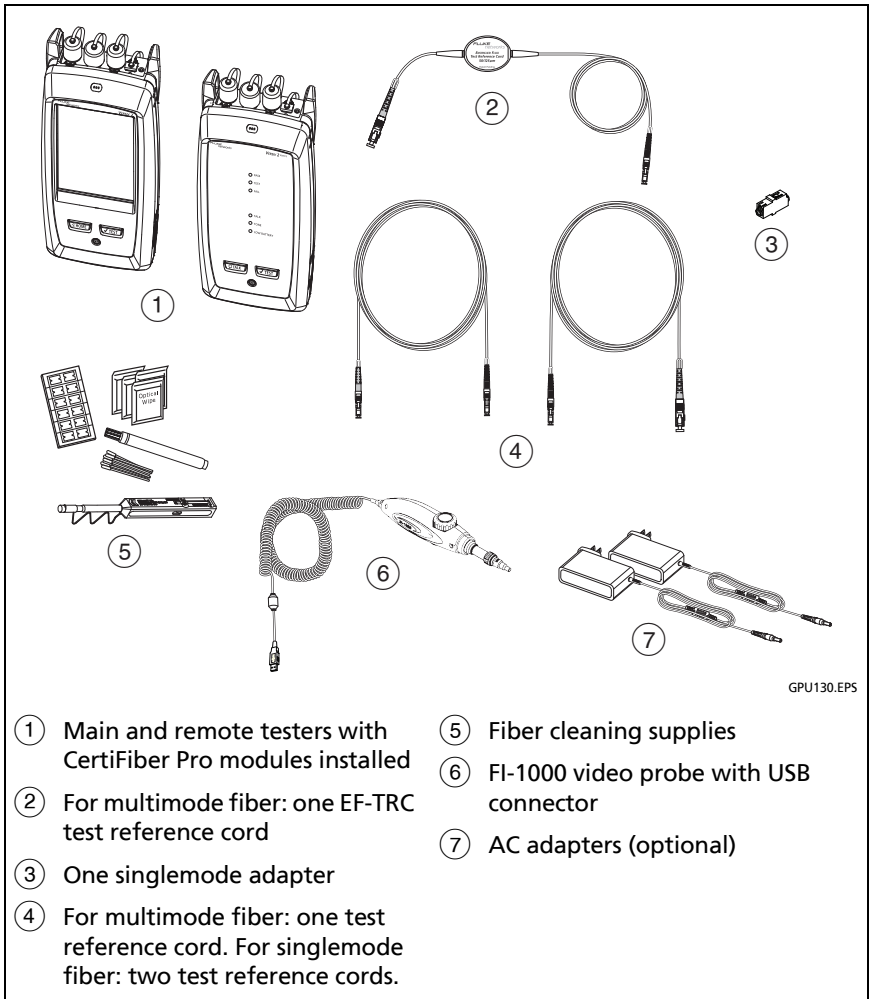

Figure 56. Equipment for Autotests in Far End Source Mode

Step 1: Set the Reference in Far End Source Mode

- 1-1 Turn on the tester and source let them sit for a minimum of 5 minutes. Let them sit longer if they are above or below ambient temperature, or if the instructions for the source specify a longer time.
- 1-2 Make sure that the home screen shows the correct settings for the job, and the test type is **Far End Source**.

To make sure that other settings are correct, tap the test setup panel, make sure the correct test is selected on the **CHANGE TEST** screen, then tap **EDIT** to see more settings. Table 7 on page 117 describes the settings.
- 1-3 Clean and inspect the connectors on the tester, source, and test reference cords.
- 1-4 On the home screen tap **SET REF**.
- 1-5 In the **TEST MODE** window, select **Auto CertiFiber Pro** or the type of source you will use, then tap **DONE**.
- 1-6 On the **SET REFERENCE** screen, tap **RUN WIZARD**.

Notes

*To only set the reference, and not measure the loss of your test reference cord, tap **SKIP WIZARD** on the **SET REFERENCE** screen.*

Fluke Networks recommends that you measure the loss of your test reference cord each time you set the reference.

- 1-7 Make the connections to set the reference as shown on the screen, then tap **NEXT** to see the completed connections. Figure 57 also shows the completed connections.

Note

*The **SET REFERENCE** screen shows reference connections for the selected reference method. Figure 57 shows connections for the **1 Jumper** reference.*

Note

When you set the reference, keep the fiber as straight as possible.

- 1-8** Turn on the optical source. On the CertiFiber Pro remote module, hold down the button adjacent to the VFL port for 3 seconds to turn on the multimode source. See Figure 58.

On CFP-QUAD modules, to turn on the singlemode source, press the button again.

Note

The CertiFiber Pro module in the remote always operates in auto wavelength mode. The output port transmits both wavelengths (850 nm and 1300 nm or 1310 nm and 1550 nm). The signal includes identifiers that tell the main tester when to measure power at each wavelength.

- 1-9** To enter the length of the test reference cord you will add to connect to the fiber under test, tap **TRC LENGTH** on the **SET REFERENCE** screen. The length you enter does not change the test results. The tester saves the length with the results to meet TIA reporting requirements.

- 1-10** Tap **SET REFERENCE**.

If reference values are unacceptable, you can use the FiberInspector probe to inspect connectors. To turn on the probe, press the button on the probe. To go back to the reference screen, tap .

- 1-11** If you did not use the connection wizard, go to step 3.

Caution

Do not disconnect the output (1) after you set the reference.

When you use the EF-TRCs, DO NOT use other mandrels.

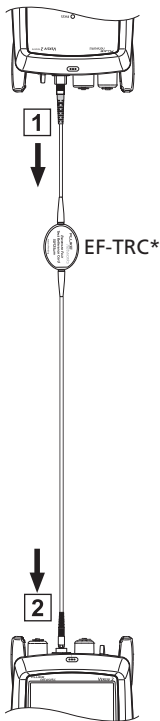

Reference

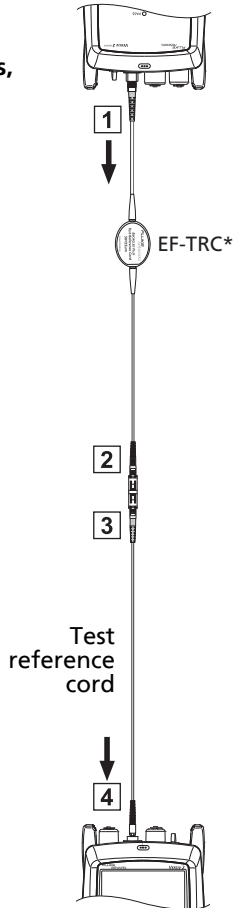

TRC Verification

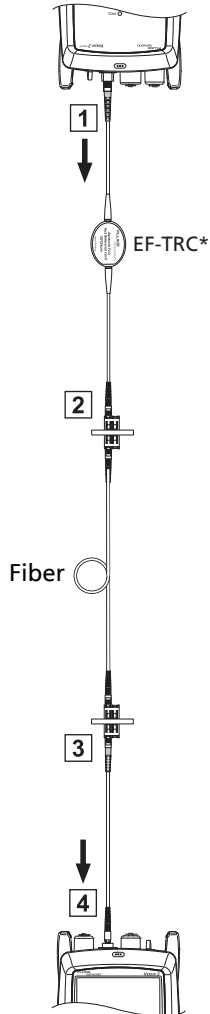

Fiber Test

*Use the EF-TRCs only with multimode modules.

GPU132.EPS

**Figure 57. Connections for Far End Source Mode
(1 Jumper Reference Multimode Fiber)**

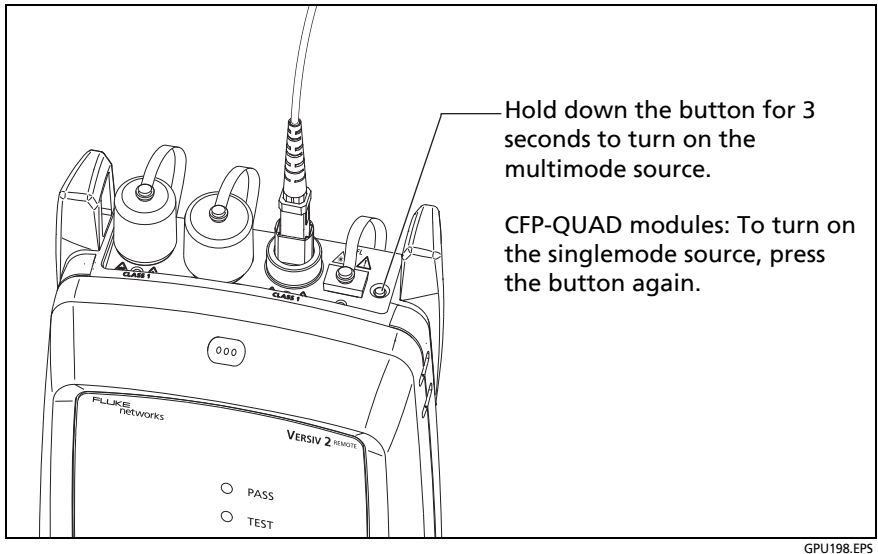

Figure 58. How to Turn on the Remote's Optical Source

Step 2: Measure the Loss of the Test Reference Cord You Will Add

Caution

If you disconnected the test reference cord from the output of the tester, you must set the reference again to make sure your measurements are reliable.

- 2-1 On the **SET REFERENCE** screen, when the reference procedure is completed, tap **NEXT**.
- 2-2 Disconnect the test reference cord from the **INPUT** port on the tester, then use a test reference cord and adapter to make the connections to verify the TRCs, as shown on the screen and in Figure 57.

-continued-

- 2-3 Tap **TRC VERIFICATION**. The tester measures and saves the loss of the test reference cord you added. The ID for this result starts with "TRC", shows the date and time of the test, and has an  for the test result.

The tester shows a warning if the loss of a TRC is more than these limits:

- **Maximum loss for multimode TRCs:** 0.15 dB
- **Maximum loss for singlemode TRCs:** 0.25 dB

If the tester shows a warning, clean and inspect the connectors on the TRC, make sure the cords are straight as shown in Figure 57, then do the TRC verification again.

Step 3: Do an Autotest in Far End Source Mode

Caution

If you disconnected the test reference cord from the output of the tester, you must set the reference again to make sure your measurements are reliable.

- 3-1 On the **SET REFERENCE**, when the set reference or TRC verification procedure is completed, tap **NEXT** to see how to connect to the fiber under test.
- 3-2 Clean and inspect the all connectors.
- 3-3 Make the connections to do the test on the fiber, as shown on the screen and in Figure 57, then tap **HOME**.
- 3-4 If necessary, select **End 1** or **End 2**: On the home screen, tap the **Next ID:** panel, then tap the **End 1/End 2** control to select an end.
- 3-5 Tap **TEST** on the main tester or press  on the main or remote tester.

- 3-6 If the **CHECK FIBER CONNECTIONS** screen shows an open fiber:
- Make sure that all connections are good and no fibers have damage. Use the VFL to make sure the fiber under test has continuity.
 - If you are connected to a fiber at a patch panel, and you are not sure you are connected to the correct fiber, connect the main tester's INPUT fiber to different connections until the test continues.
- 3-7 If **Auto Save** is on, the tester uses the next ID to save the results.

If **Auto Save** is off, the **SAVE RESULT** screen shows the next ID available. You can change the ID if necessary.

Note

*To put **End 1/End 2** results together in the same record, use LinkWare software to merge the results.*

Autotest Results for Far End Source Mode

Figure 59 shows an example of Autotest results for Far End Source mode.

Note

*The Autotest in Far End Source mode does not show a **PASS/FAIL** result, limit, or margin if the selected test limit uses fiber length to calculate loss. An example of such a limit is the TIA-568C Fiber Backbone limit. The tester does not measure length in Far End Source mode.*

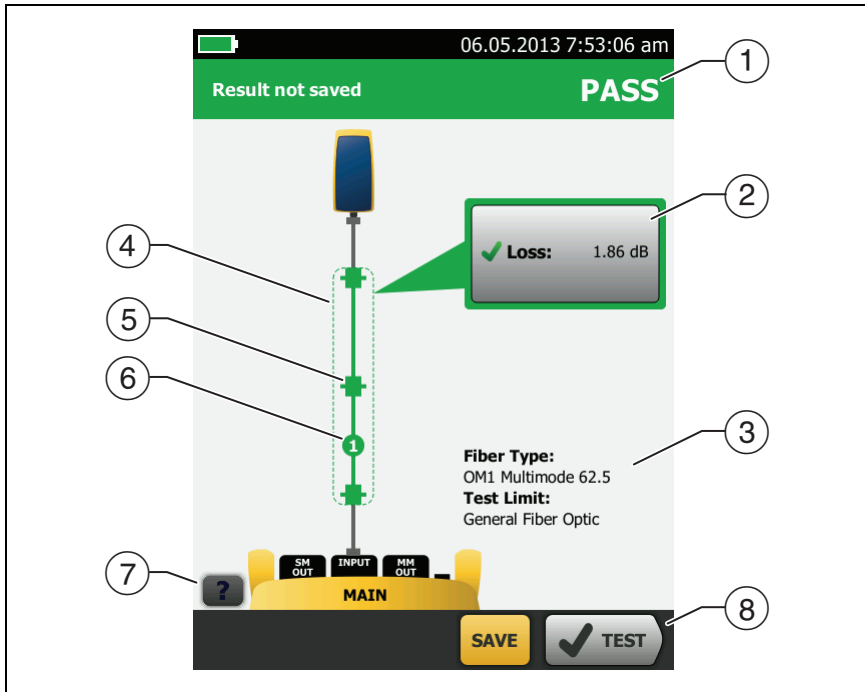

GPU120.EPS

Figure 59. Result for Far End Source Mode

- ① The overall result for the Autotest.
- ② The loss and length measurements for the fiber:
 - ✗ The result exceeds the limit.
 - ✓ The result is within the limit.
 - ℹ The selected test limit does not have a limit for the test.To see the results, limit, and margins for the fiber, tap the window.
- ③ The settings the tester used for the test.

- ④ The dashed lines are around the connectors and fiber that are included in the loss and length results. Gray connectors and fibers are not included because you used them to set the reference.
- ⑤ Connector icons show the number you entered for the **TOTAL CONNECTIONS** setting on the **No. of Connectors/Splices** screen (Figure 48 on page 120). For Figure 59, the **TOTAL CONNECTIONS** setting is 1.
- ⑥ The round icon shows the number of splices entered for the **SPLICES** setting on the **No. of Connectors/Splices** screen.
- ⑦ To see help for the screen, tap .
- ⑧ When more than one button shows at the bottom of the screen, the tester highlights one in yellow to recommend which one to tap. See “Buttons to Do Tests and Save Results” on page 19.

Bi-directional Tests

Do bi-directional tests when they are required by the manufacturer or by your customer.

The tester can automatically do bi-directional tests in Smart Remote and Loopback modes. To get bi-directional results in Far End Source mode, do a test from each end of the fiber.

In Smart Remote mode, the tester saves bi-directional results in two records. Each record contains the results for one fiber for both directions.

To do a bi-directional test

Note

*When you make connections for a bi-directional test in Smart Remote mode, connect the fiber that has the **Input Fiber ID** to the main tester's **OUTPUT** port, and the fiber that has the **Output Fiber ID** to the main tester's **INPUT** port. Halfway through the test, you will switch the connections.*

- 1 Set the reference and measure the loss of the TRCs for the mode you will use:
 - Smart Remote mode: See “Step 1: Set the Reference in Smart Remote Mode” on page 126 and “Step 2: Measure the Loss of the Test Reference Cord You Will Add” on page 128.
 - Loopback Mode: See “Step 1: Set the Reference in Loopback Mode” on page 134 and “Step 2: Measure the Loss of the Test Reference Cord You Will Add” on page 136.
- 2 Connect to the link as shown on the left side of Figure 60.
- 3 On the home screen, tap the test setup panel, make sure the correct test is selected on the **CHANGE TEST** screen, then tap **EDIT**.
- 4 On the **TEST SETUP** screen, in the **Bi-directional** panel, tap the control to make it show **On**, then tap **SAVE**.
- 5 Do an Autotest.
- 6 Halfway through the test, the tester tells you to switch the input and output fibers. Connect to the link as shown on the right side of Figure 60.

 **Caution**

Switch the connections at both ends of the patch panel or fiber under test, not at the tester's and remote's ports. If you disconnect a test reference cord from an output port on the tester or remote, the reference value will be unreliable.

Note

*The directions **Main>Remote** (main to remote) and **Remote>Main** (remote to main) in the bi-directional results are only the directions of the optical signals for the second half of the test. If a fiber fails, the direction does not tell you the location of the problem.*

- 7 If **Auto Save** is on and the tester is in Smart Remote mode, the tester uses the next two IDs to save the results for the two fibers.

If **Auto Save** is off, and you tap **SAVE** or **FIX LATER**, the **SAVE RESULT** screen shows the next two IDs available. You can change the IDs if necessary.

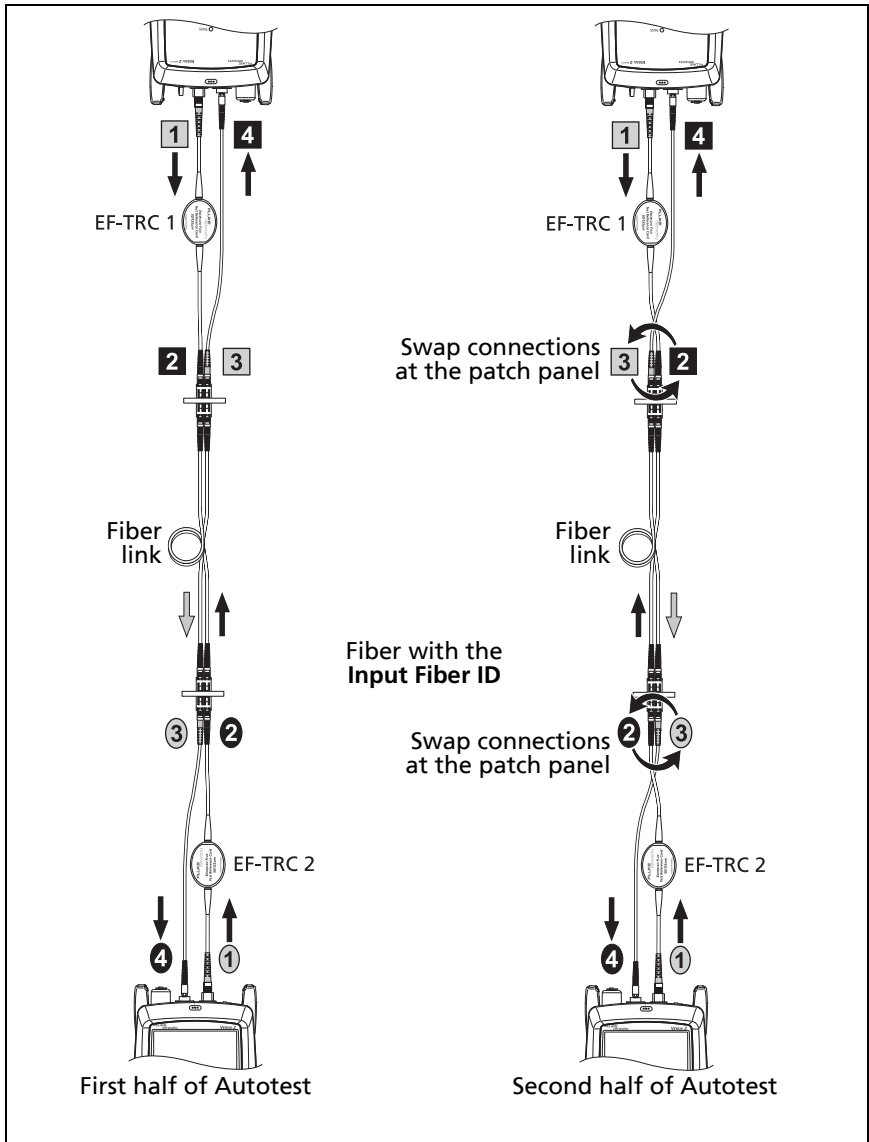

GPU227.EEPS

Figure 60. Connections for a Bi-directional Test in Smart Remote Mode (1 Jumper Reference, Multimode Fiber)

Chapter 7: Use the OTDR



Before you use the tester, read the safety information that starts on page 5.

Overview of Features

The OptiFiber® Pro Optical Time Domain Reflectometer (OTDR) module attaches to a Versiv and Versiv™ 2 main unit to make a rugged, hand-held tester that lets you locate, identify, and measure reflective and loss events in multimode and singlemode fibers. Typical maximum test ranges are 35 km maximum at 1300 nm for multimode fiber and 130 km maximum at 1550 nm for singlemode fiber. The modules include these features:

- Automatic analysis of OTDR traces and events helps you identify and locate faults on multimode (850 nm and 1300 nm; 50 μ m and 62.5 μ m) and singlemode (1310 nm and 1550 nm) fiber.
- Shows OTDR results as an intuitive map of events, a table of events, and an OTDR trace.
- Automatic bi-directional averaging gives you more accurate loss measurements than measurements made in one direction.
- Gives a PASS or FAIL result based on a test limit that you specify.
- “Document Only” test limit is available if PASS/FAIL results are not necessary.
- Event editing function lets you edit loss events. See Chapter 9.
- Span function lets you limit OTDR results to a section of fiber that you define. See Chapter 9.

- Touchscreen lets you quickly navigate through different views of the results and see more information about events.
- SmartLoop™ test: One test gives you OTDR results for both fibers in a link.
- DataCenter OTDR™ test gives optimal performance when you do tests on fiber installations that have short links, many connections, and possibly large reflections.
- FaultMap™ test lets you make maps of your cable plant, see patch cords as short as 0.5 m, and see events that have poor reflectance.
- Visual fault locator helps you verify the continuity of fibers and locate faults in fibers and connectors.
- Optional FiberInspector™ video probe lets you inspect fiber endfaces and save the images in test reports.

Connectors, Keys, and LEDs

See Figure 61.

- ① LCD display with touchscreen.
- ② Singlemode OTDR port with interchangeable SC adapter and protective cap. The LED in front of the port turns on when the port emits an optical signal.

Caution

Do not connect APC (angled physical contact) connectors to the OTDR ports. Doing so can damage the port's endface, and the large reflection at the OTDR port can cause unreliable test results.

- ③ Multimode OTDR port with interchangeable SC adapter and protective cap. The LED in front of the port turns on when the port emits an optical signal.
- ④ Visual fault locator port and protective cap. The LED in front of the port turns on when the port emits an optical signal.

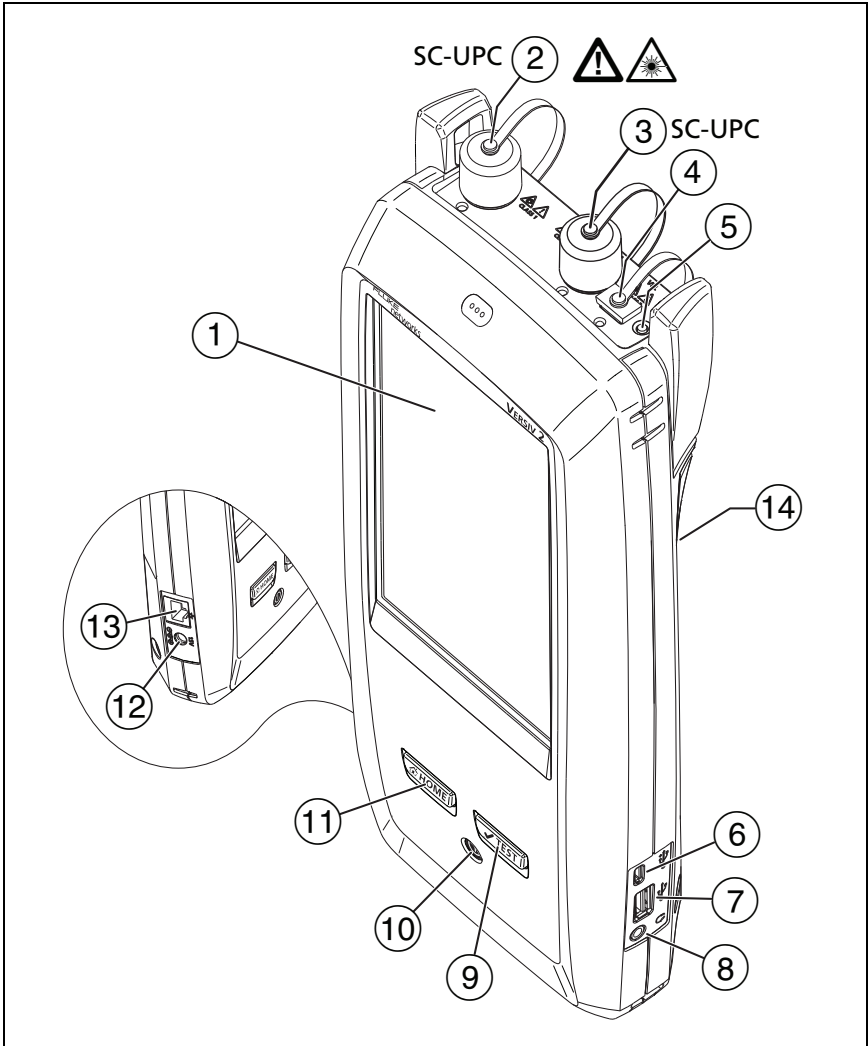





GPU06.EPS

**Figure 61. Connectors, Keys, and LEDs
(Versiv 2 with OptiFiber Pro Quad OTDR shown)**



Warning

Do not look directly into optical connectors. Some sources emit invisible radiation that can cause permanent damage your eyes.

- ⑤ Button that controls the VFL.
- ⑥ Micro USB port: This USB port lets you connect the tester to a PC so you can upload test results to the PC and install software updates in the tester.
- ⑦ Type A USB port: This USB host port lets you save test results on a USB flash drive and connect the FI-1000 video probe to the tester. On a Versiv main tester, this port lets you or connect a Wi-Fi adapter for access to the Fluke Networks cloud service LinkWare Live. (Versiv 2 testers have an internal Wi-Fi radio.)
- ⑧ Headset jack.
- ⑨  **TEST**: Starts a test. To start a test, you can also tap **TEST** on the display.
- ⑩ : Power button. Versiv 2: The LED in the power button shows the status of the battery charging process. See Table 2 on page 13.
- ⑪ : Press  to go to the home screen.
- ⑫ Connector for the AC adapter. Versiv: The LED is red when the battery charges, and green when the battery is fully charged. The LED is yellow if the battery will not charge. See “Charge the Battery” on page 12.
- ⑬ RJ45 connector: Lets you connect to a network for access to Fluke Networks cloud services.
- ⑭ Decal with laser safety information:



λ = 650nm, 0.85mW IEC/EN 60825-1 Complies with 21 CFR 1040.10 and 1040.11 except for deviations pursuant to Laser Notice 50, dated June 24, 2007

How to Remove and Install the Connector Adapters

You can change the connector adapters on the OTDR ports of the modules to connect to SC, ST, LC, and FC fiber connectors. You can remove the adapter also to clean the fiber endface in the port. See Figure 62.

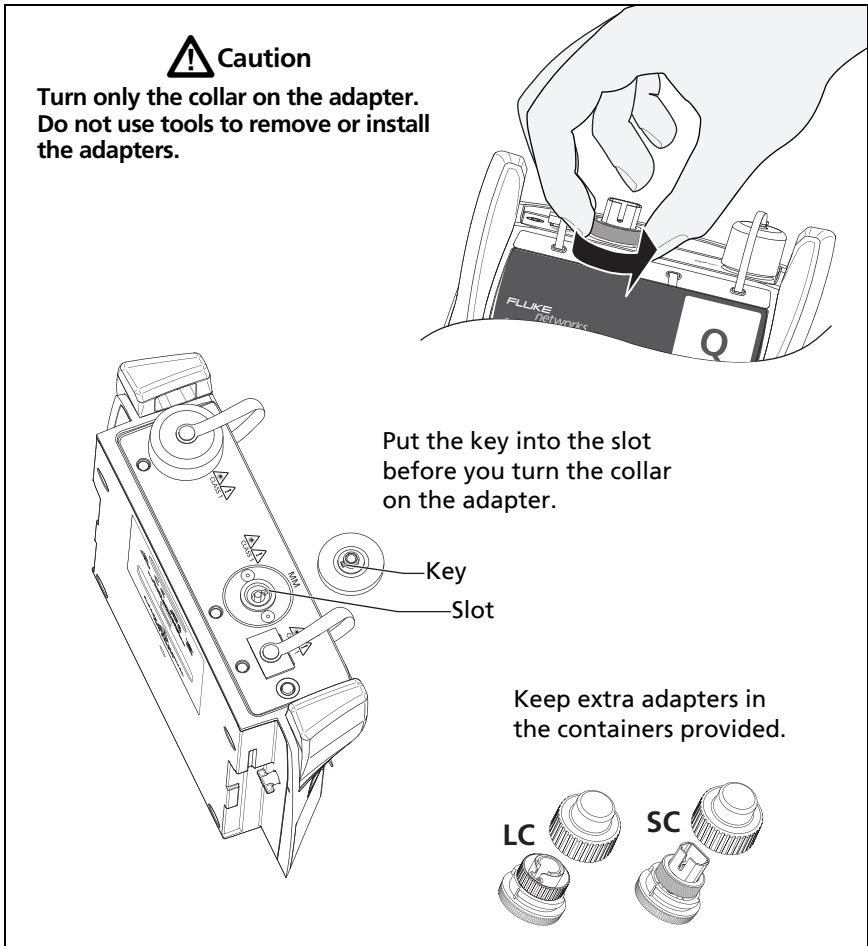

GPU165.EPS

Figure 62. How to Remove and Install the Connector Adapters

The OptiFiber Pro Home Screen

The home screen (Figure 63) shows important test settings. Before you do a test, make sure these settings are correct.

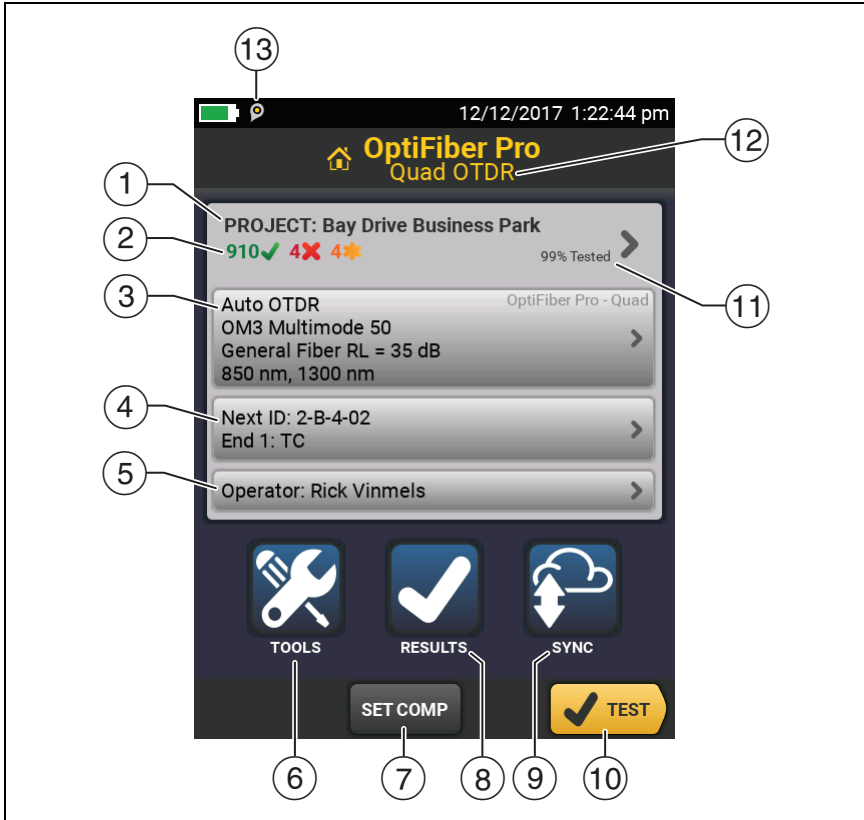



GPU02.EPS

Figure 63. The Home Screen for OptiFiber Pro Modules

- ① **PROJECT:** The project contains the settings for a job and helps you monitor the status of a job. When you save test results, the tester puts them in the project. Tap the **PROJECT** panel to edit the project settings, select a different project, or make a new project.

- ② Shows a summary of the test results in the project:

 : The number of tests that passed.

 : The number of tests that failed.

- ③ The test setup panel shows the settings the tester will use when you tap **TEST** or press .

To change these settings, tap the panel, select the test on the **CHANGE TEST** screen, tap **EDIT**, select different settings on the **TEST SETUP** screen, then tap **SAVE**.

Note

You can set up tests for any module that the tester can use, even when no module is attached.

- ④ **Next ID:** The **Next ID** panel shows the ID that the tester gives to the next test results you save.

Tap **Next ID** to do these tasks:

- Enter an ID, select a different ID in the ID set, select a different set of IDs, or make a new set. The tester adds the IDs and ID sets you make to the project that shows on the home screen.
 - Turn **Auto Save** on or off.
 - Select **End 1** or **End 2** for OTDR and FiberInspector tests.
 - Enter a name for **End 1** and **End 2**.
- ⑤ **Operator:** The name of the person who does the job. You can enter a maximum of 20 operator names. For each operator you can also enter the email address that the operator will use as an ID to sign in to LinkWare Live.
- ⑥ **TOOLS:** The **TOOLS** menu lets you set up the compensation function for the launch/tail cords, use tools such as the real-time trace and the FiberInspector test, see the status of the tester, and set user preferences such as the language and the display brightness.

- ⑦ **SET COMP:** Lets you select a launch method and set the lengths of launch and tail cords. See “About Launch and Tail Cords” on page 165.
- ⑧ **RESULTS:** Tap **RESULTS** to see and manage the results that are saved in the tester.
- ⑨ **SYNC:** Tap **SYNC** to sync projects with LinkWare Live.
- ⑩ **TEST:** Tap **TEST** to do the test shown in the test setup panel. The percentage of the tests in the project that are completed.
- ⑪ **% Tested:** The tester uses the number of available IDs and the tests you selected on the **CABLE ID SETUP** screen to calculate this percentage. See Figure 118 on page 298.

% Tested does not show if your project contains only a **Next ID** list. See “About Next ID Sets” on page 297 for more information about the **Next ID** list.
- ⑫ The type of module attached to the tester. If no module is attached, this screen shows **HOME**.
- ⑬  The asset management icon shows when the owner of a LinkWare Live account has enabled the asset management service on the tester. “About the Asset Management Service” on page 309.

Settings for OTDR Tests

Table 8 gives descriptions of the settings for OTDR tests.

To set up a project, which includes the settings in Table 8, cable IDs, and operator names, see Chapter 13.

To set up an OTDR test

- 1 On the home screen, tap the test setup panel.
- 2 On the **CHANGE TEST** screen, select an OTDR test to change, then tap **EDIT**.

Or to set up a new OTDR test, tap **NEW TEST** then tap a **Test Type**.

- 3 On the **TEST SETUP** screen, tap the panels to change settings for the test. See Table 8.
- 4 On the **TEST SETUP** screen, tap **SAVE** when your test setup is completed.
- 5 On the **CHANGE TEST** screen, make sure the button next to the test is selected, then tap **USE SELECTED**.

Note

*For all Test Types except **FaultMap** and **FiberInspector**, you can use the **SETUP** button on the **TRACE** screen to change some OTDR settings manually after a test. See “How to Quickly Change OTDR Settings After a Test” on page 184.*

Table 8. Settings for OTDR Tests

Module	<p>Select the OTDR module you will use.</p> <p>To select a different module, tap the Module panel on the TEST SETUP screen, then tap a module.</p>
Test Type	<p>When you turn on the tester, the Test Type shows the test that was last selected.</p> <p>Auto OTDR: The tester automatically selects settings that give you the best view of the events on the cabling. This mode is the easiest to use and is the best choice for most applications. To see the settings the tester used for an Auto OTDR test, tap SETTINGS on the trace screen.</p> <p style="text-align: center;"><i>Note</i></p> <p style="text-align: center;"><i>Some unusual faults can cause the Auto OTDR test to show an unsatisfactory trace. If this occurs, use the Manual OTDR test to get a better trace.</i></p> <p>Manual OTDR: This mode lets you select settings to control the test parameters for the trace. See the Technical Reference Handbook.</p> <p style="text-align: right;">-continued-</p>

Table 8. Settings for OTDR Tests (continued)

<p>Test Type (continued)</p>	<p>DataCenter OTDR: This test is optimized for fiber installations that have short links, many connections, and the possibility of large reflections.</p> <p style="text-align: center;"><i>Notes</i></p> <p><i>By default, the DataCenter OTDR test uses 850 nm for multimode fiber and 1310 nm for singlemode fiber. These are the wavelengths typically used in data centers. You can select other wavelengths if necessary. You must use launch compensation when you do a DataCenter OTDR test.</i></p> <p>FaultMap: The FaultMap test can show connections that do not show on the OTDR EventMap and connections that are poor because they have high reflectance. See “The FaultMap Test” on page 186.</p> <p>SmartLoop OTDR (Auto) and SmartLoop OTDR (Manual): The SmartLoop test lets you connect the far ends of the two fibers in a link so that one OTDR test gives you results for both fibers. The Auto and Manual settings operate the same as for the OTDR test. See “The SmartLoop Test” on page 192.</p> <p>FiberInspector: The FiberInspector test lets you use an optional FI-7000 FiberInspector™ video probe to inspect the endfaces in fiber optic connectors. See Chapter 5.</p>
<p>Manual OTDR Settings</p>	<p>This item shows only if you select Manual OTDR or SmartLoop OTDR (Manual) for the Test Type. Manual OTDR mode lets you select settings to control the test parameters for the trace. See the Technical Reference Handbook.</p>
<p>Bi-directional</p>	<p>This setting shows only if you select SmartLoop OTDR (Auto) or SmartLoop OTDR (Manual) for the Test Type.</p> <p>Off: The tester does the SmartLoop test in only one direction.</p> <p>On: The tester does the SmartLoop test in both directions and automatically calculates bi-directional averages of loss. See “Bi-directional SmartLoop Tests” on page 199.</p>

Table 8. Settings for OTDR Tests (continued)

Launch Compensation	Tap the control to turn the launch compensation function on or off. See “About Launch and Tail Cords” on page 165.
Macrobend Detection (singlemode only)	<p>On: The tester identifies bends. To identify a loss event as a bend, the tester compares the event’s loss at two wavelengths, such as 1310 nm and 1550 nm. If the loss is more at the longer wavelength and is more than the macrobend threshold, the tester identifies the event as a bend. This setting is On by default.</p> <p>For the Auto OTDR test, the threshold for the loss difference is 0.50 dB. To use a different threshold, set up a Manual OTDR test. You can change the Macrobend Setup in the Manual OTDR Settings. See the Technical Reference Handbook.</p> <p style="text-align: center;"><i>Notes</i></p> <p style="text-align: center;"><i>A bend always causes a FAIL result. If you want a PASS result for a link that has a bend, turn off Macrobend Detection.</i></p> <p>Off: The tester does not identify bends. Bends show as loss events in the results.</p>
Wavelength	<p>Select the wavelengths you want to use. You can do tests at one or all of the wavelengths supported by the module you selected. The FaultMap and FiberInspector tests do not have this setting.</p> <p style="text-align: center;"><i>Note</i></p> <p style="text-align: center;"><i>If you use only one wavelength, the Macrobend Detection function will not identify bends.</i></p>
Fiber Type	Select a fiber type that is correct for the type you will test. To see a different group of fiber types, tap MORE , then tap a group.

-continued-

Table 8. Settings for OTDR Tests (continued)

<p>Fiber Type Settings</p>	<p>IR: The tester uses the index of refraction to calculate the optical length of the fiber. Each fiber type includes the value specified by the manufacturer. To use a different IR, make a custom fiber type. See the Technical Reference Handbook.</p> <p>Backscatter: Backscatter is the backscatter coefficient. The tester uses this value to calculate the reflectance of events for OTDR tests and the overall ORL for the link. Each fiber type includes the value specified by the manufacturer. To use a different backscatter value, make a custom fiber type. See the Technical Reference Handbook.</p>
<p>Test Limit</p>	<p>Select the correct test limit for the job. Generic limits, such as General Fiber Optic and Document Only, let you do tests when no industry-standard limit is applicable and you do not want to make a custom limit. These limits are in the Miscellaneous group. To see a different group of limits, tap MORE, then tap the name of a group.</p> <p>Some test limits use the measured length of the fiber to calculate a limit for loss.</p>
<p>Test Limit Settings</p>	<p>This item shows only if the selected test limit calculates a loss limit for each link. For such limits, enter the number of connectors and splices in the link. See the Technical Reference Handbook.</p>

About Launch and Tail Cords

Launch and tail cords let the tester measure the loss and reflectance of the first and last connectors in the cabling and also include them in the measurement of overall loss. Without launch and tail cords, no backscatter is available before the first connector nor after the last. To measure the properties of a connector, the tester must measure the backscatter before and after the connector.

The launch cord also lets the you see events that are close to the OTDR. Without a launch fiber, those events can be hidden by the large reflection, or dead zone, caused by the OTDR's port.

Fluke Networks recommends that you use launch and tail cords. You should also use the launch/tail cord compensation function to remove the lengths of these fibers from the OTDR measurements.

If you select a test limit that requires you to use launch and tail cords, the tester shows a warning message when you try to do an OTDR test without launch and tail cords.

Caution

For tests on cabling that has angled physical contact (APC) connectors, use only launch/tail cords that have APC connectors at the ends connected to the cabling. Other connector types cause large reflections that can cause unreliable test results.

Notes

Do not use hybrid patch cords to connect the launch or tail cords to the cabling under test. Use launch and tail cords with the correct connectors to connect directly to the cabling under test. This gives the best measurement of the first and last connectors in the link. Launch and tail cords with different types of connectors are available from Fluke Networks.

Notes

***Launch + Tail** compensation usually gives the most accurate measurements.*

The style of the case for your launch/tail cords can be different from the cords shown in this manual.

How to Set Up the Launch Compensation Function

- 1 Select launch and tail cords that have the same type of fiber as the fiber you will test.
- 2 On the home screen, tap the test setup panel. On the **CHANGE TEST** screen, select an OTDR test to change, then tap **EDIT**. Or to set up a new OTDR test, tap **NEW TEST** then tap **Auto OTDR**, **Manual OTDR**, or **DataCenter OTDR**.
- 3 On the **TEST SETUP** screen, tap the **Launch Compensation** control to set it to **On**.
- 4 On the **TEST SETUP** screen, make sure the **Fiber Type** is correct. Change it if necessary.
- 5 On the **TEST SETUP** screen, tap **SAVE**.
- 6 On the home screen, tap **SET COMP**.
- 7 On the **SET LAUNCH METHOD** screen tap the type of compensation you want to do.
- 8 Clean and inspect the OTDR port and the launch/tail cord connectors.
- 9 Make the connections for the type of compensation you selected, as shown on the **SET LAUNCH METHOD** screen.
- 10 Tap **SET**.
- 11 When the **SET LAUNCH COMP** screen shows, select the event or events that are the end of the launch cord and the start of the tail cord (if you used a tail cord).
- 12 Tap **SAVE**.

Figure 74 shows an example of an OTDR trace with launch and tail markers enabled.

Note

If you change the launch or tail cord, do the compensation procedure again.

How to Prevent Damage to the Launch Cord Connectors

When you do not use a launch cord, keep the connectors attached to the case or inside the case. See Figure 64.

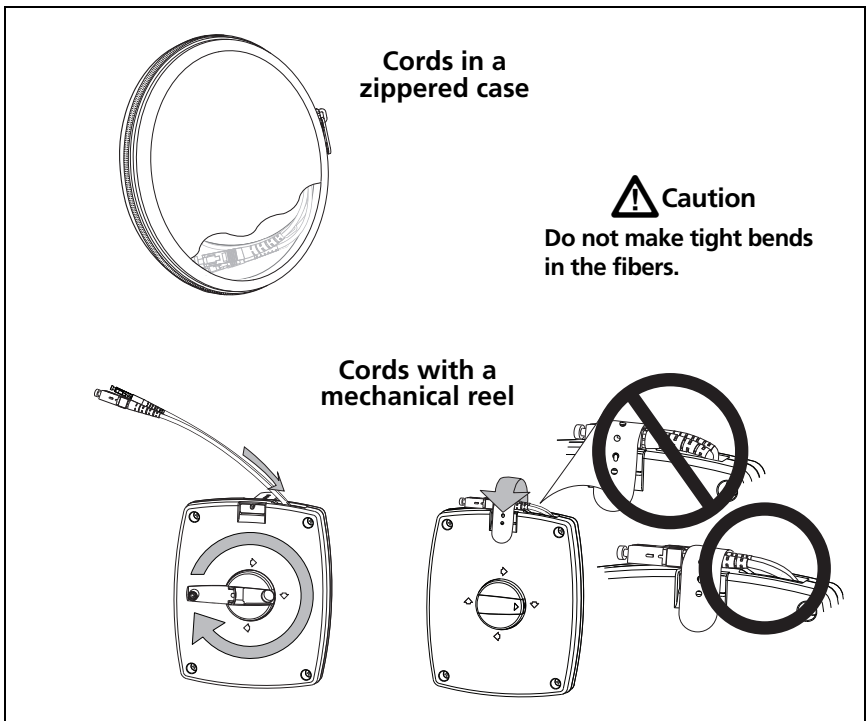
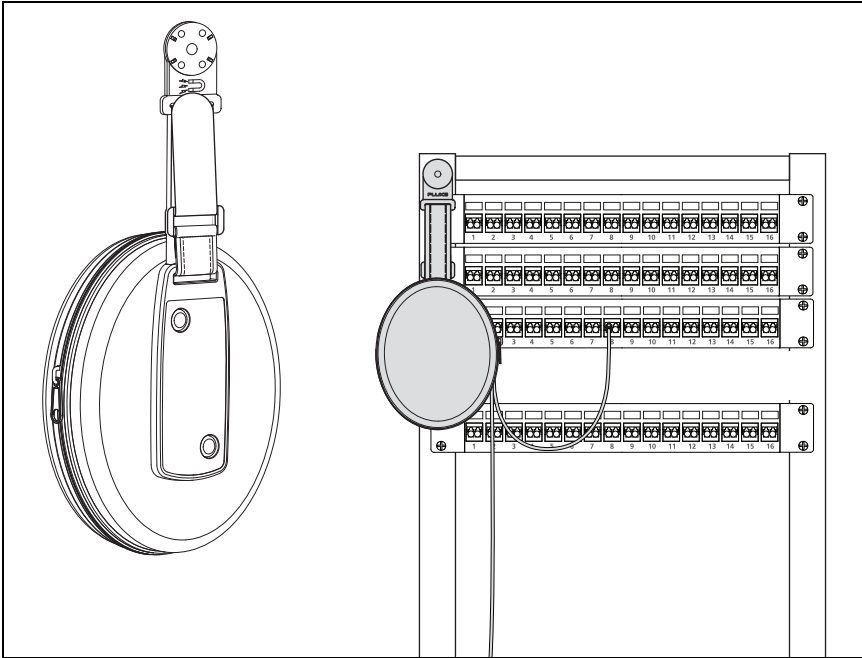

Figure 64. How to Prevent Damage to the Launch Cord Connectors

How to Hang the Launch Cords

The optional TPAK magnet and strap let you hang the launch cords from metal surfaces (Figure 65).



GPU191.EPS

Figure 65. How to Use the Optional TPAK Magnetic Hanger

OTDR Port Connection Quality

When you do an OTDR test, the test shows the quality of the OTDR port connection (Figure 66). If a test takes more than approximately 3 seconds, the **PROGRESS** screen also shows a preview of the OTDR trace. The trace is black for one wavelength and blue for the other wavelength.

If the Gauge is Not in the Good Range

- Clean the OTDR port and the fiber connector. Use a video probe to inspect the endfaces in the port and fiber connector for scratches and other damage. If an endface on the tester shows damage, contact Fluke Networks for service information.
- If the gauge stays outside the **Good** range, remove the adapter from the module and inspect the adapter for damage. Make sure that the white plastic ring inside the center tube shows no damage.

A poor OTDR connection increases the dead zone at the connector. The dead zone can hide faults that are near the OTDR connector.

A poor connection also decreases the strength of the signal from the OTDR. The weaker signal causes more noise on the trace, which can cause the OTDR to miss events. It also decreases the dynamic range.

When the test is completed, the quality gauge shows in the details for the **OTDR Port** event on the EventMap screens. The tester includes the gauge with the test results you save.

Port Connection Quality for SmartLoop Tests

For SmartLoop tests, the **OTDR Port** connection for the second fiber is the input connector of the loopback cord. See Figures Figure 81 on page 197 and Figure 83 on page 202. If the tester shows a message about the connection quality of the OTDR port,

but the OTDR connection on the tester is good, inspect the ends of the loopback cord.

“STOP” Button for Manual Tests

When a trace shows on the **PROGRESS** screen for a manual OTDR test with multiple wavelengths, you can tap the **STOP** button to stop the OTDR test at the current wavelength and start the test at the next wavelength (Figure 66). This lets you control the time the tester takes to give OTDR results. You can stop the test to get results more quickly, but the results are possibly less accurate.

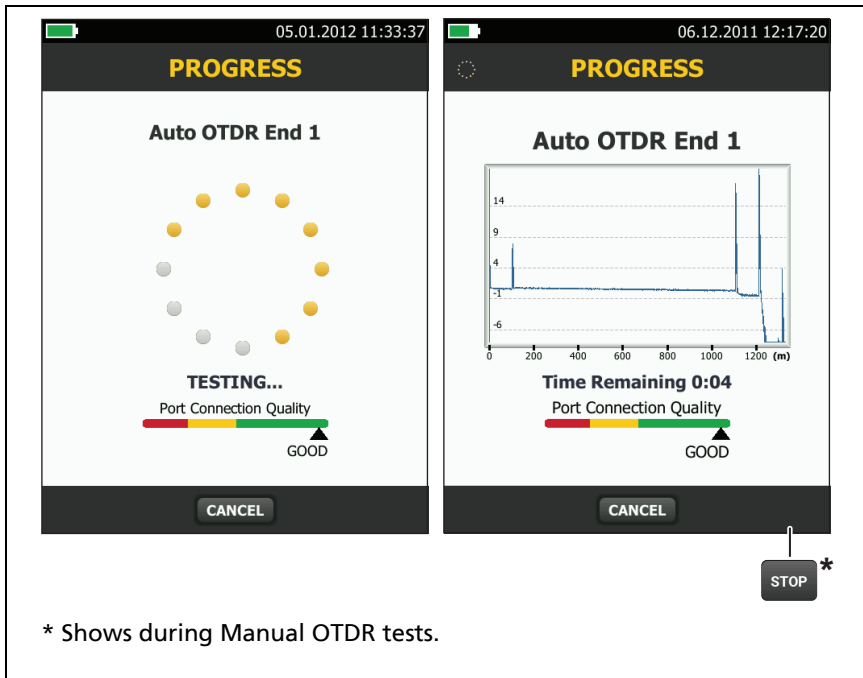



Figure 66. The OTDR Port Connection Quality Gauge and Progress Screen

How to Do an OTDR Test

Figure 67 shows the equipment for OTDR tests.

To do an OTDR test

- 1 Make sure that the home screen shows the correct settings for the job.
- 2 Clean and inspect the connectors on the launch and tail cords and the fiber to be tested.
- 3 Connect the tester to the link as shown in Figure 68, 69, or 70.
- 4 Tap **TEST** or press .

Note

The tester shows a warning if there is an optical signal on the fiber.

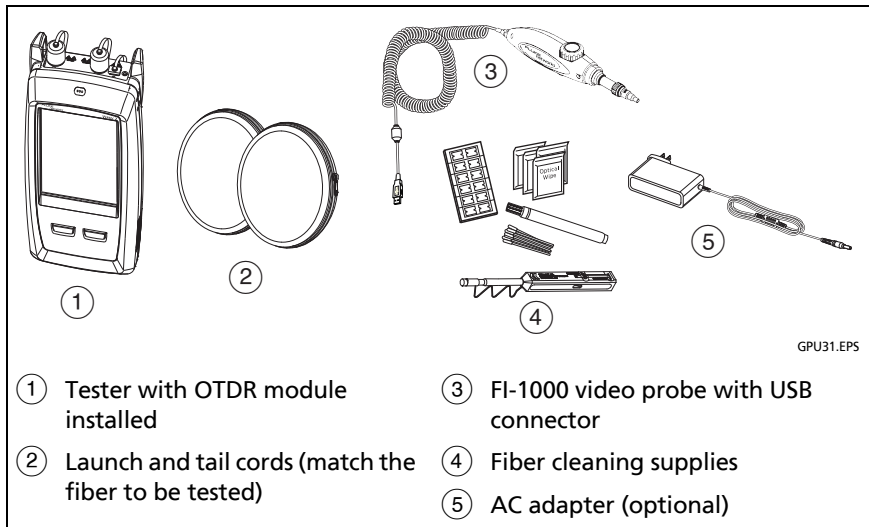
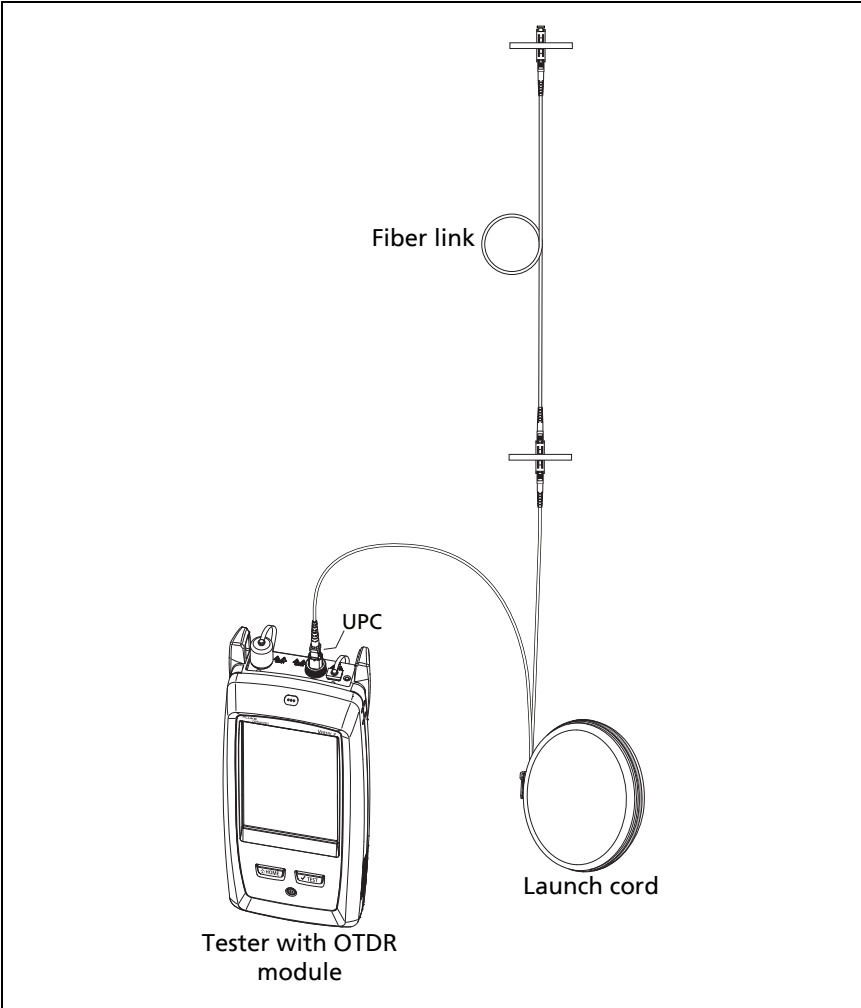
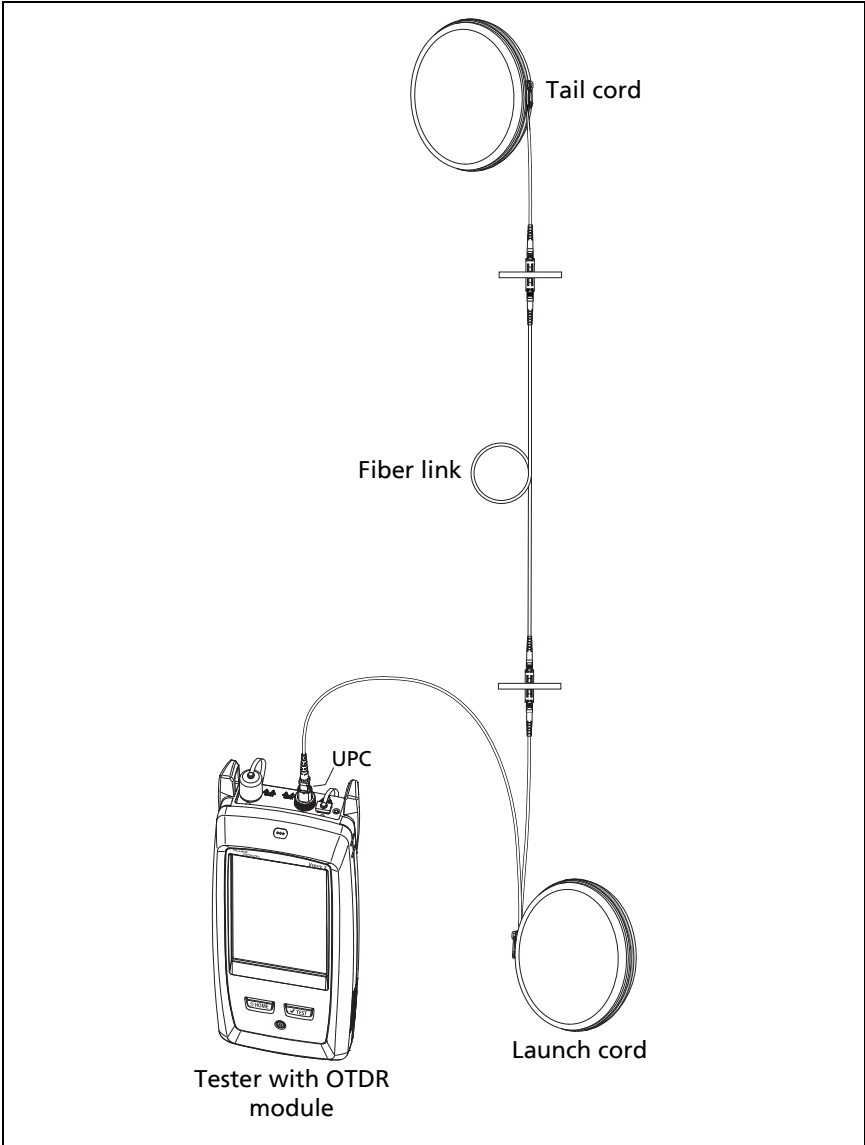

Figure 67. Equipment for OTDR Tests



GPU03.EPS

Figure 68. OTDR Connected with a Launch Cord



GPU04.EPS

Figure 69. OTDR Connected with Launch and Tail Cords

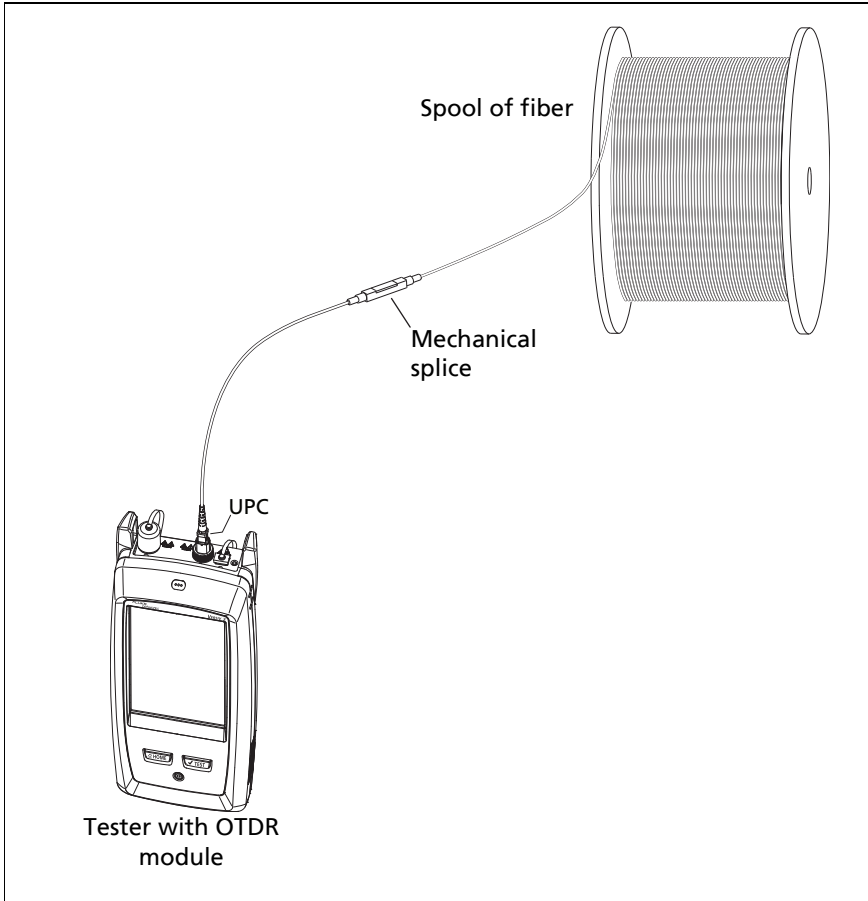

Figure 70. OTDR Connected to a Spool of Fiber

GPU05.EPS

OTDR Results

Notes

The tester shows measurements with ">" or "<" when the actual value is possibly more or less than the value shown. For example, this can occur for hidden events or for measurements that are out of the range of the tester.

*When a test is completed, the type of screen the tester shows first (**EventMap**, **TABLE**, or **TRACE**) is the type you looked at last.*

EventMap

Notes

The EventMap combines the results for all wavelengths used for the test. If an event on the EventMap does not show on the event table or OTDR trace, change the wavelength on the OTDR screen.

The EventMap does not show ghosts.

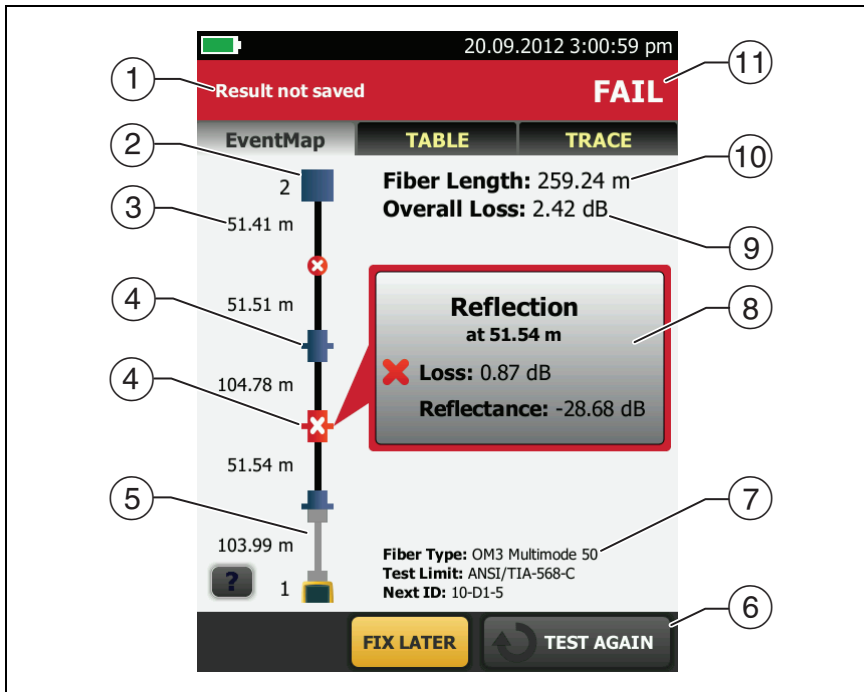

See Figures 71 and 72.



GPU11.EPS

Figure 71. EventMap Example 1

- ① The ID for the results. If **Auto Save** is off, **Result not saved** shows.
- ② The end of the fiber.
- ③ The length of the fiber segment between two events.
- ④ A reflective event:
 - : A reflective event, which is usually a connector. Measurements for the event are all within the test limits.
 - ✖: One or more measurements for the event exceeds the limit. This event could also be a **Ghost Source**.

- ⑤ : Launch and tail cords and their connectors show in gray. The map shows these if **Launch Compensation** is on and the cords are connected.
- : The arrow icon shows when there are more events that do not show on the screen. To see the events, tap the icon or scroll the map.
- ⑥ When more than one button shows at the bottom of the screen, the tester highlights one in yellow to recommend which one to tap. See “Buttons to Do Tests and Save Results” on page 19.
- ⑦ The fiber type and test limit the tester used for the test, and the ID the tester will use for the next results that you save.
- ⑧ When a test is completed, the window shows information for the event that has the worst measurement. The information windows show the worst results of the wavelengths used for the test.

If the window border is green, the measurements for the event do not exceed the limits.

If the window border is red, a measurement exceeds the limits.

If the window border is blue, the tester does not give a pass or fail result to the event because it cannot do a full analysis of the event. This occurs for **OTDR Port**, **Hidden**, and **End** events. This occurs for all events if you use the **Document Only** test limit because **Document Only** does not have values for limits.

When you use a test limit that has a reflectance limit, **Hidden** events show a fail status if their reflectance exceeds the limit.

: The measurement exceeds the limit.

: The measurement is within the limit.

To see details for the event, tap the window.

To see information for another event, tap another icon on the map.

Note

Events before the launch cord connector and after the tail cord connector do not have a pass or fail status.

- ⑨ **Overall Loss:** The loss of the cabling. This does not include the OTDR connection and the loss of the last event. If **Launch Compensation** is on, the overall loss includes the launch and tail connectors, but not the launch and tail fibers.

If you did the test at two wavelengths, the tester shows the highest loss of the two wavelengths.

N/A shows for the **Overall Loss** if the tester cannot measure the loss. This can occur when events are too close together or when there is a large reflective event near the end of the fiber.

- ⑩ **Fiber Length:** The length of the fiber. The units show in meters (**m**) or feet (**ft**). If **Launch Compensation** is on, the length does not include the length of the launch and tail cords.
- ⑪ **PASS/FAIL:** The overall result for the fiber.
- **PASS:** All measurements are within the test limits.
 - **FAIL:** One or more measurements exceed the limit.

Refer to Figure 72:

- ① Length of the tail cord (top) and launch cord (bottom).
- ② A non-reflective loss event:

: An APC connector or a splice. Measurements for the event are all within the test limits. If the event has negative loss, it is a **Gainer**.

If **Macrobend Detection** is **Off**, this could be a bend. If the event is a bend, and **Macrobend Detection** is **On**, the EventMap shows the bend icon. Macrobend detection is available only for singlemode fibers.

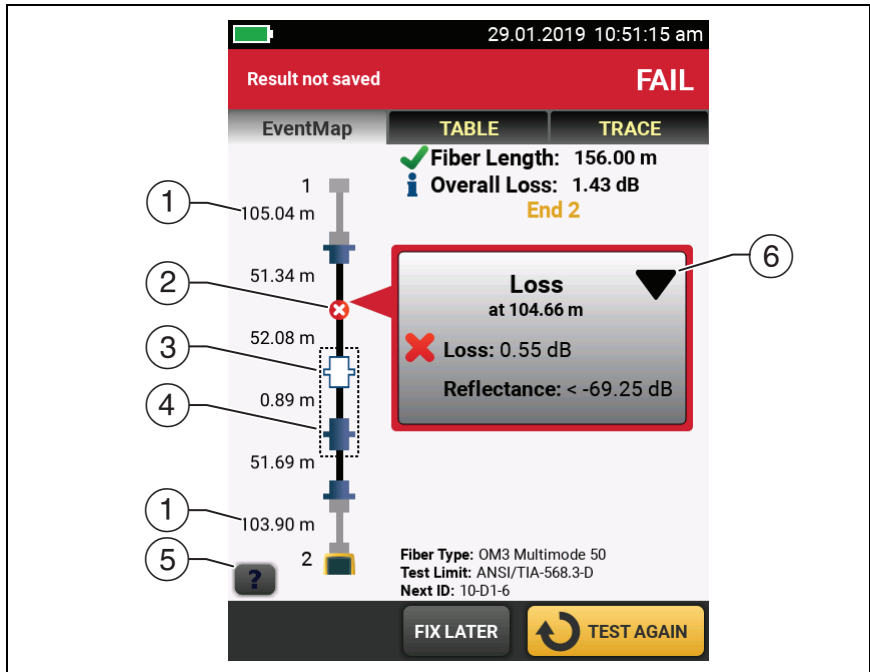

GPU22.EPS

Figure 72. EventMap Example 2

✗: One or more measurements for the event exceeds the limit.

⤿: A bend with loss that exceeds a macrobend threshold. If **Macrobend Detection** is **Off**, the EventMap shows the blue circle shown above. Macrobend detection is available only for singlemode fibers.



Note

*A bend always causes a **FAIL** result. If you want a **PASS** result for a link that has a bend, turn off **Macrobend Detection**.*

③ □: The event is hidden by a previous event.

The map shows a dotted line around hidden events and the event that causes them to be hidden. The tester combines the loss of all the events that are in the dotted line. To see the combined loss, tap the event that causes the hidden event (④). The tester does not show loss measurements for hidden events.

: The event is hidden by a previous event. The reflectance of the event exceeds the limit. This icon shows only when the test limit has a limit for reflectance.

- ④ The cause of the hidden event. In this example, the cause is a connector on a short patch cord. The loss of the second connector is hidden in the attenuation dead zone of the first connector.
- ⑤ Tap  to see information about the selected event.
- ⑥  The event editing function lets you edit loss events. See “How to Edit a Loss Event” on page 259.

Event Table

The event table shows a list of the events on the fiber. To see the event table, tap **TABLE** on the OTDR results screen. Figure 73 shows an example of an event table.

- ① To see details for an event, tap the event in the table. Scroll the table if necessary to see all the events.
 - **(ft)** or **(m)**: The distance to the event
 - **LOSS**: The loss of the event.
 - **REFLECT**: The reflectance of the event.
 - **TYPE**: The event type.

Note

*The **OTDR Port** and **End** events always show **N/A** for loss because backscatter measurements are not available on both sides of those events.*

If an event shows “---” in the **LOSS** and **REFLECT** columns, the tester did not find the event at the selected wavelength. Tap an arrow button (⑤) to see the measurements for the other wavelength.

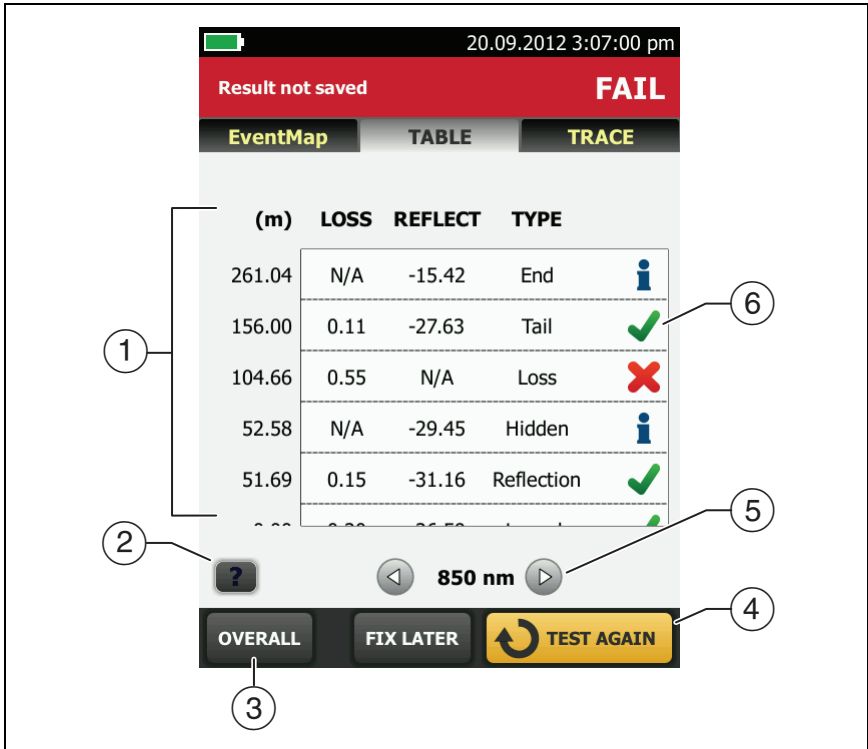

GPU12.EPS

Figure 73. Event Table

- ② Tap **?** to see help for this screen.
- ③ **OVERALL**: Tap this button to see overall measurements of length, loss, and optical return loss for the fiber.

- ④ When more than one button shows at the bottom of the screen, the tester highlights one in yellow to recommend which one to tap. See “Buttons to Do Tests and Save Results” on page 19.
- ⑤ If the tester made measurements at two wavelengths, tap the arrow buttons to see results for the other wavelength. Possibly, some events show only at one wavelength.
- ⑥ : The measurement is within the limit.

: The measurement exceeds the limit.

: The tester does not give a pass or fail result to the event. This occurs for **OTDR Port**, **Hidden**, and **End** events. This occurs for all events if you use the **Document Only** test limit because **Document Only** does not have values for limits.

When you use a test limit that has a reflectance limit, **Hidden** events show a **FAIL** status if their reflectance exceeds the limit.

To see details for an event, such as limits for measurements and the **SEGMENT ATTENUATION** coefficient, tap the event in the table.

OTDR Trace

To see the OTDR trace, tap **TRACE** on the OTDR results screen. Figure 74 shows an example of an OTDR trace.

- ① The decibel scale shows the level of backscatter. The tester sets the backscatter level at the start of the trace to approximately 0 dB.
- ② The measurement cursor. To measure loss and distance, tap the yellow circle so that **MARK** shows, drag the cursor to the start of the measurement, tap **MARK**, then drag the cursor to the end of the measurement.

- ③ When the cursor is on an event, this area shows the event type. The text is green if the event passed, red if the event failed, or black if there is no limit for measurements. The event type does not show after you tap **MARK** to use the measurement cursor.
- ④ Tap **?** to see help for this screen.

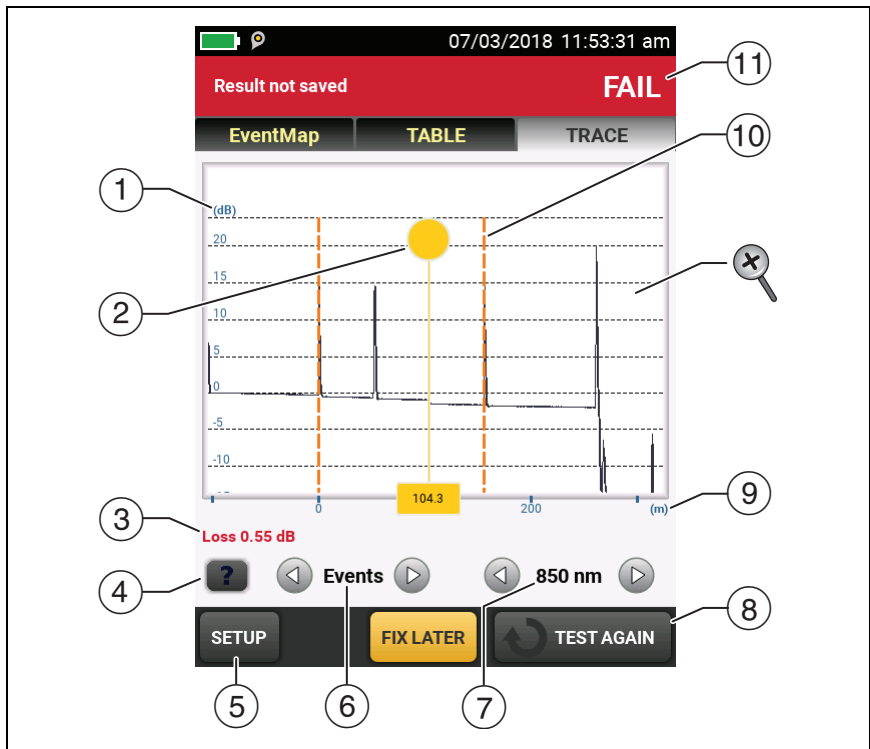







Figure 74. OTDR Trace

GPU14.EPS

- ⑤ Tap **SETUP** to change the **RANGE**, **PULSE WIDTH**, **AVERAGING TIME**, and wavelengths for the test. See "How to Quickly Change OTDR Settings After a Test" on page 184. You can also tap **CURRENT** to see the settings used on the test.

- ⑥ Tap  or  to move the cursor to another event.
- ⑦ The wavelength the tester used for the test. If the tester used more than one wavelength, tap  or  to see the other wavelength. Possibly, some events show only at one wavelength.

When **All** shows, the screen shows the traces for all wavelengths.

- ⑧ When more than one button shows at the bottom of the screen, the tester highlights one in yellow to recommend which one to tap. See “Buttons to Do Tests and Save Results” on page 19.
 - ⑨ The distance scale shows the distance along the fiber.
 - ⑩ Markers for the end of the launch cord and the beginning of the tail cord are orange, dashed lines.
 - ⑪ **PASS:** All measurements were within the limits.
FAIL: One or more measurements exceeded its limit.
-  To zoom in and out, use the pinch, reverse-pinch, and double-tap gestures on the touchscreen. You can also use the zoom controls to change the magnification on the distance and decibels scales independently. See Figure 3 on page 18.

How to Quickly Change OTDR Settings After a Test

After an OTDR test, you can quickly change some OTDR settings when you want to try different settings on the same fiber. After you do a test, tap **SETUP** on the **TRACE** screen, then select settings on the **MANUAL OTDR** screen (Figure 75).

You can save your settings to the **Active** test setup or to a **New** test setup, or you can tap **TEST** to do a test without saving the settings.

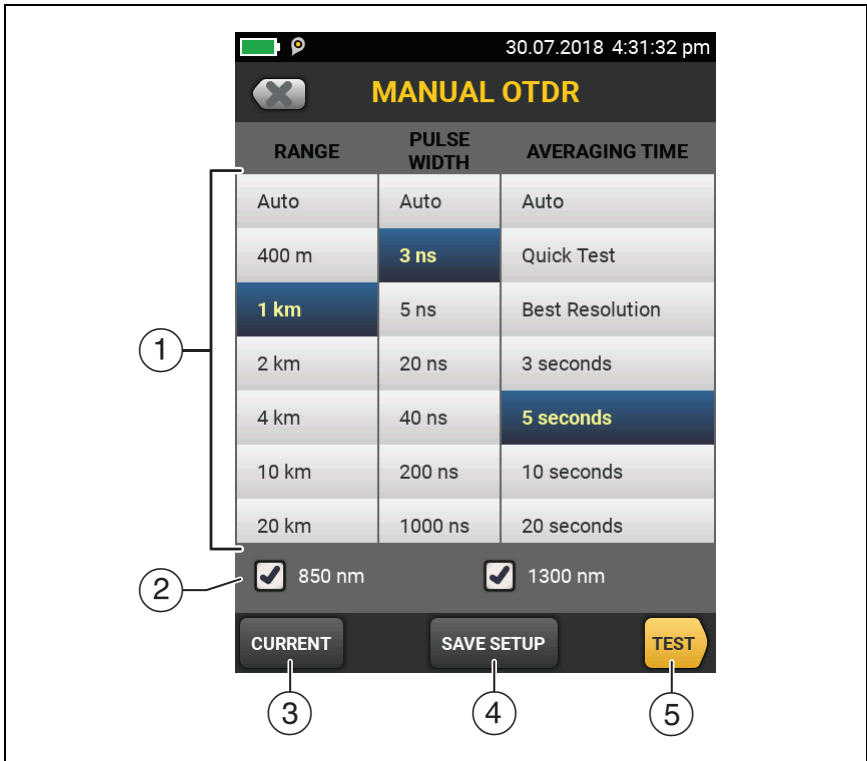

GPU220.EPS

Figure 75. Manual OTDR Screen for Quick Changes After a Test

- ① Tap the settings you want. You can scroll some columns to see more settings. Table 8 on page 161 gives descriptions of the settings.
- ② Select the wavelengths to use for the test.
- ③ Tap **CURRENT** to see the settings the tester used for the last test.
- ④ The **SAVE SETUP** button lets you save your settings:

Active: The tester saves the settings in the active test setup, and changes the active **Test Type** to **Manual**.

New: The tester saves the settings in a new **Manual** test setup that is added to the project. The tester uses the **Manual** setup until you save the results or exit the results screen then start a test from the home screen. Then the tester uses the test setup it had before you changed the OTDR settings.

If you save your settings in a New test setup:

The tester uses your settings until you save the results or exit the results screen then start a test from the home screen. Then the tester uses the test setup it had before you changed the settings.

If you do not save your settings:

The tester uses your settings until you save the results or exit the results screen then start a test from the home screen. Then the tester uses the test setup it had before you changed the settings.

- ⑤ Tap **TEST** or press **TEST** to do a test with the settings you selected.

The **PROGRESS** screen shows **Manual OTDR** when the tester uses your settings.

Note

If you want to use your settings when you are finished with this test, make sure you save them. See item ④.

The FaultMap Test

The FaultMap test helps you record the connections in a fiber link and identify bad connections. It can show short patch cords and find connections that have high reflectance. The FaultMap test gives you these results:

- Shows a map of the connectors in the link that possibly do not show on the OTDR EventMap. The map includes connectors that are hidden in the dead zones made by previous events. The FaultMap test shows patch cords as short as 0.5 m for lengths < 2 km.
- Shows connections that are poor because they have high reflectance (> -35 dB).

Reflective events that are apparently not connectors do not show on the FaultMap diagram. Loss events, including bends, are also not shown.

The FaultMap test finds events that have a reflectance larger than approximately -50 dB on multimode fiber and -60 dB on singlemode fiber. (More negative values mean less reflectance and a better connection. For example, a connector with a reflectance of -40 dB is better than one with -35 dB.)

Notes

Since the FaultMap test finds only reflections, do not use it to look for fusion splices or angled physical contact (APC) connectors.

*FaultMap results do not include a **PASS/FAIL** status. The results are only for your documentation of the link.*

FaultMap tests on singlemode fiber usually take more time than OTDR tests. The test uses very narrow pulses on singlemode fiber to make the smallest event dead zones possible, and does more analysis on the reflections in the link.

How to Do the FaultMap Test

Notes

The FaultMap test does not use the launch compensation settings.

The FaultMap test uses the wavelength that gives the best results.

Figure 76 shows the equipment for the FaultMap test.

- 1 Clean and inspect the connectors on the launch and tail cords or patch cords and the link to be tested.
- 2 Connect the launch cord to the OTDR port and the link to be tested, as shown in Figure 77. Connect a tail cord to the far end of the link if necessary.

Or, you can use a patch cord that is 1 m long at minimum to connect the tester to the link. To see results for the far-end connector, connect a tail cord or patch cord (>1 m) to the far end of the link.

- 3 On the home screen, tap the test setup panel.
- 4 On the **CHANGE TEST** screen, tap the button next to the **FaultMap** test, then tap **USE SELECTED**. If a FaultMap test is not available, tap **NEW TEST** to add one to the project.
- 5 Tap **TEST** or press **TEST**.

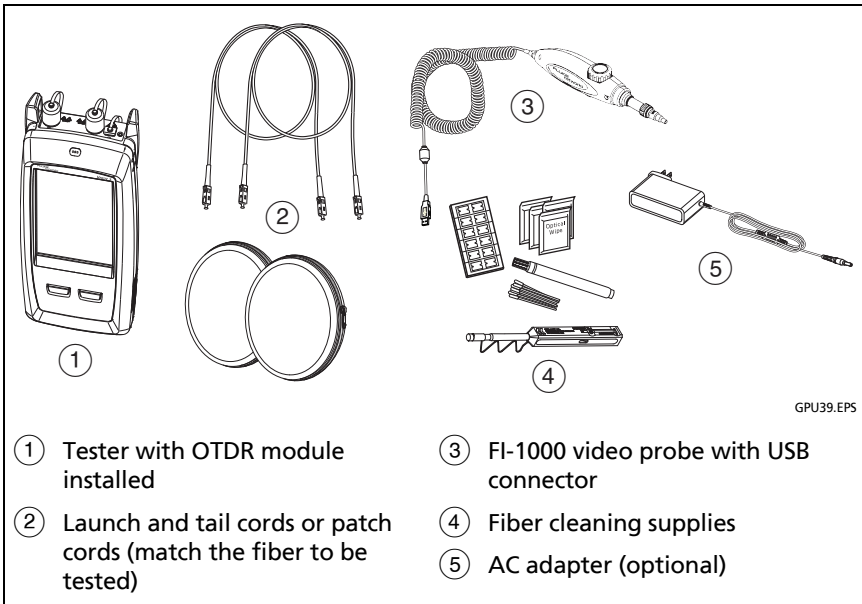

Figure 76. Equipment for FaultMap Tests

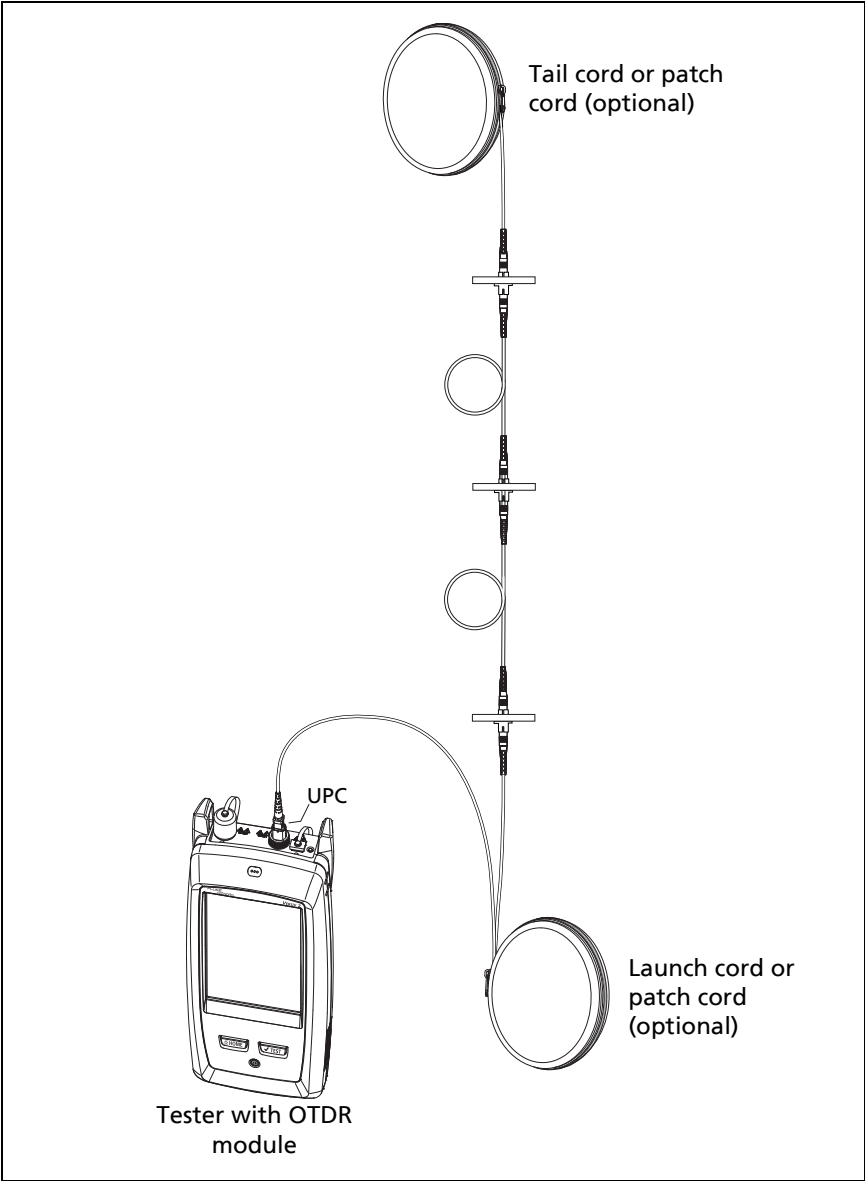

Figure 77. FaultMap Test Connections

GPU41.EPS

FaultMap Screen

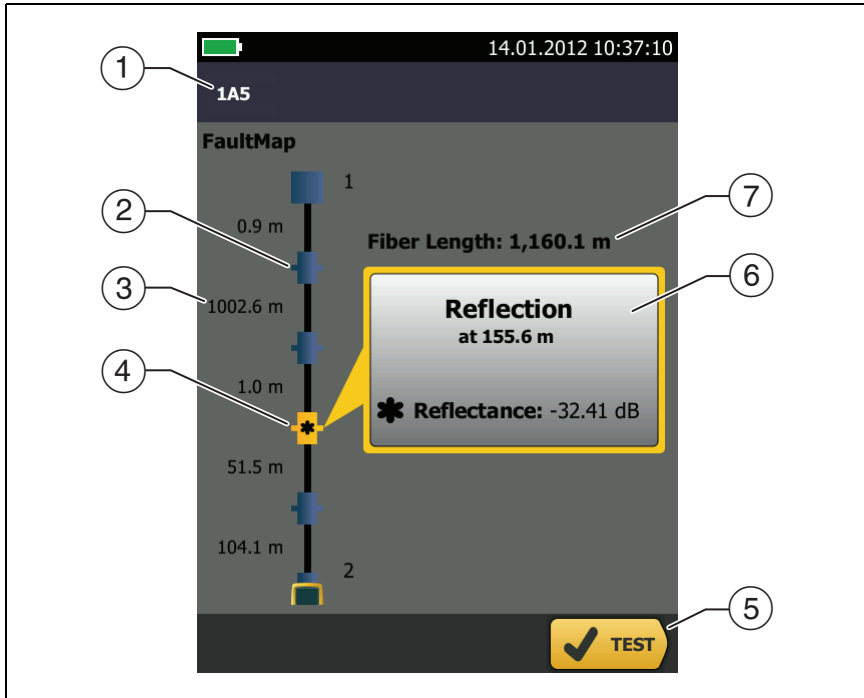





Figure 78. FaultMap Screen

Note

The FaultMap test does not use the launch compensation settings. The results show the launch and tail cords and their connectors in the same colors as other cords and connectors.

- ① The ID for the results. If **Auto Save** is off, **Result not saved** shows.
- ② : An event that has a reflectance smaller than -35 dB.
- ③ The length of the fiber segment between two events.

- ④ : An event that has a reflectance larger than -35 dB. It is possibly a connector that is dirty, poorly polished, scratched, cracked, misaligned, unseated, worn, or the wrong type.
- : The arrow icon shows when there are more events that do not show on the screen. To see the events, tap the icon or scroll the screen.
- ⑤ When more than one button shows at the bottom of the screen, the tester highlights one in yellow to recommend which one to tap. See “Buttons to Do Tests and Save Results” on page 19.
- ⑥ If the window is blue, the reflectance of the event is smaller than -35 dB. If the window is orange, the reflectance is larger than -35 dB.
- To see the window for another event, tap another icon on the fiber.
- ⑦ **Fiber Length:** The length of the fiber. This includes the lengths of the launch and tail cords, if you used them.

The SmartLoop Test

The SmartLoop test lets you connect the far ends of the two fibers in a link and do one OTDR test to get separate results for each fiber.

You use a launch cord to connect the fibers together at the far end of the link. When you do the SmartLoop test, the tester uses the launch compensation settings to remove the effects of the loopback cord and its connectors.

The Auto and Manual settings for the SmartLoop test operate the same as for the OTDR test. See Table 8 on page 161.

Figure 79 shows the equipment for the SmartLoop test.

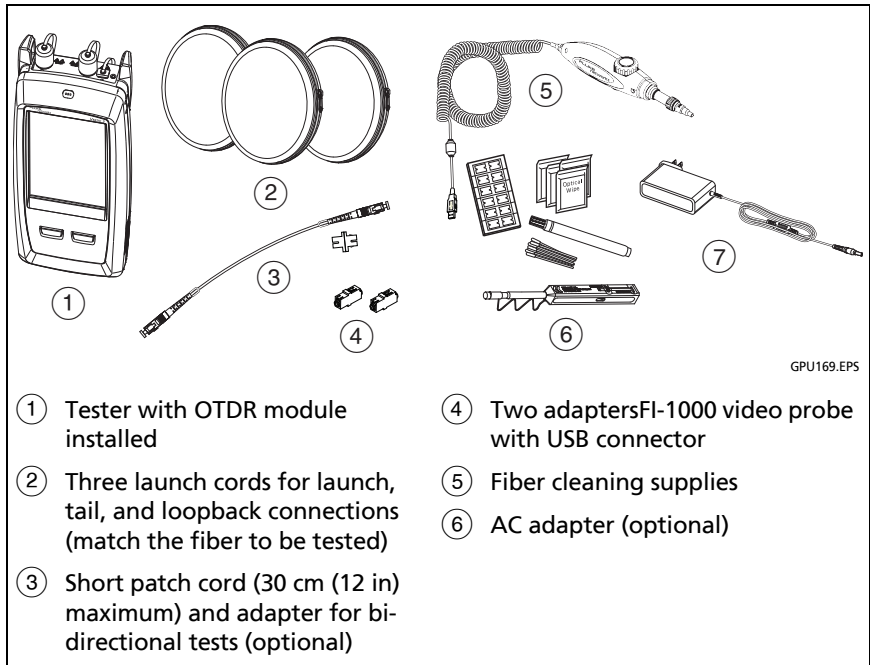

Figure 79. Equipment for SmartLoop Tests

How To Do an Auto SmartLoop Test

Set up the launch compensation function

- 1 On the home screen, tap the test setup panel.
- 2 On the **CHANGE TEST** screen, tap the button next to the Auto SmartLoop test, then tap **USE SELECTED**.

If an Auto SmartLoop test is not available, tap **NEW TEST** to add one to the project. Select settings as necessary on the **TEST SETUP** screen. See “Settings for OTDR Tests” on page 161.

- 3 Select three launch cords that have the same type of fiber as the fiber you will test.
- 4 On the home screen, tap **SET COMP**.
- 5 On the **SET LAUNCH METHOD** screen tap **SmartLoop**.
- 6 Clean and inspect the OTDR port and connectors on the three launch cords.
- 7 Make the connections shown in Figure 80.
- 8 Tap **SET**.
- 9 When the **SET LAUNCH COMP** screen shows, make sure the tester shows the correct distances for the end of the launch cord and the start of the tail cord.

Note

*If the fibers have APC connectors, the tester possibly will not find the correct launch and tail events. If this occurs, do the compensation again and select **Manual Entry** to enter the lengths of the cords manually.*

- 10 Tap **SAVE**.

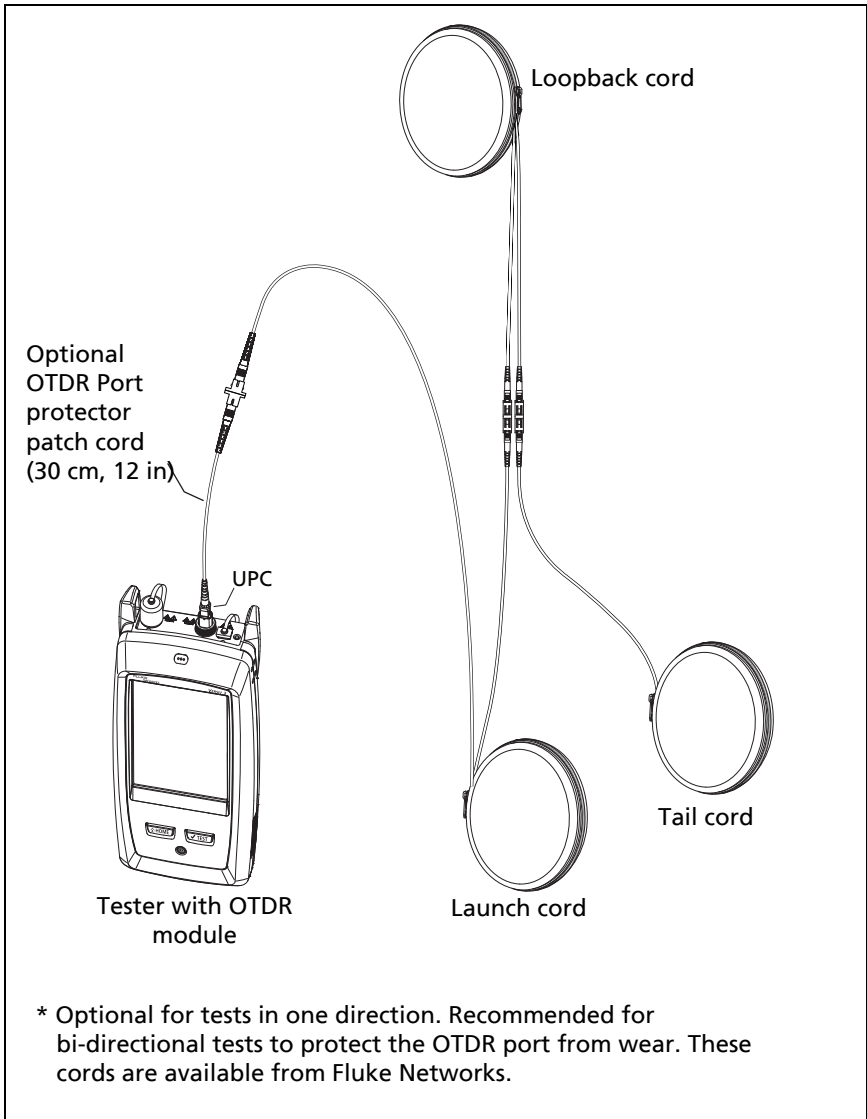

Figure 80. SmartLoop Launch Compensation Connections

Do the SmartLoop test

- 1 Make the connections shown in Figure 81.
- 2 On the home screen, make sure the IDs for the fibers are correct. The tester uses the **Fiber A** ID for the fiber connected to the launch cord.
- 3 Tap **TEST** or press TEST.

Note

If the tester shows a message about the connection quality of the OTDR port, but the OTDR connection on the tester is good, inspect the ends of the loopback cord. See “Port Connection Quality for SmartLoop Tests” on page 169.

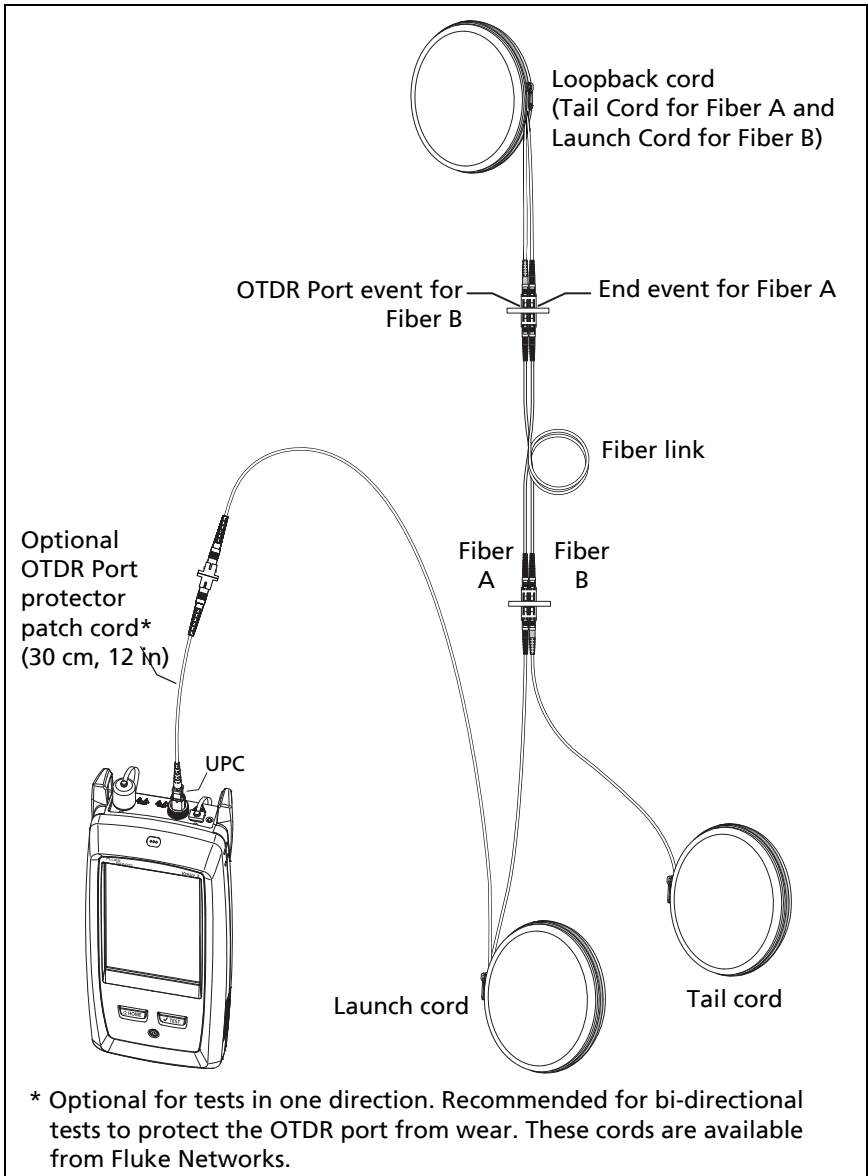

GPU171.EPS

Figure 81. SmartLoop Test Connections

SmartLoop Results

The tester shows the SmartLoop results on two sets of **EventMap**, **TABLE**, and **TRACE** screens, one for each fiber in the link. See Figure 82.

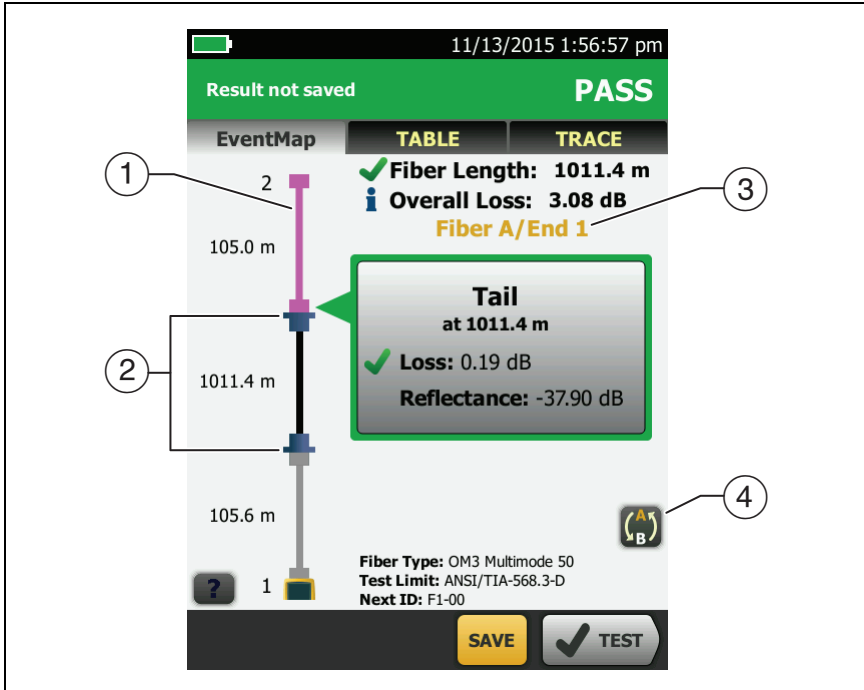

GPU172.EPS

Figure 82. EventMap from a SmartLoop Test

- ① The purple fiber is the loopback cord.
- ② The fiber between the launch cord and the loopback cord is the fiber on one side of the link.
- ③ **Fiber A** is the side of the link connected to the OTDR at **End 1**.
- ④ To switch between results for fibers A and B, tap  on the EventMap screen.

Note

When you save SmartLoop results, the tester saves the results in two records, one for each fiber in the link.

Bi-directional SmartLoop Tests

OTDR tests from both ends of a fiber can give different results because some properties of fiber and fiber components can cause differences in the loss measurements in each direction.

For example, the loss of an event is the difference between the backscatter levels before and after the event. If a segment after a connector or splice has a higher backscatter value than the segment before, the tester shows different values of loss for the connector or splice from the two directions.

For splices, which have very little loss, the difference in the backscatter of the two fibers can cause an apparent gain in power across the splice in one direction.

For this and other reasons, bi-directional averages of connector and splice loss in both directions are more accurate than measurements from one direction.

The bi-directional SmartLoop test gives you bi-directional OTDR results for both fibers in a link. The tester also automatically calculates averages of the two results and includes the averaged values in the test record.

How to Do a Bi-directional SmartLoop Test

Set up the launch compensation function

- 1 On the home screen, tap the test setup panel, make sure the correct SmartLoop test is selected on the **CHANGE TEST** screen, then tap **EDIT**.

-continued-

If an Auto SmartLoop test is not available, tap **NEW TEST** to add one to the project. Select settings as necessary on the **TEST SETUP** screen. See "Settings for OTDR Tests" on page 161.

- 2 On the **TEST SETUP** screen, in the **Bi-directional** panel, tap the control to make it show **On**, then tap **SAVE**.
- 3 On the **CHANGE TEST** screen, tap **USE SELECTED**.
- 4 Select three launch cords that have the same type of fiber as the fiber you will test.
- 5 On the home screen, tap **SET COMP**.
- 6 On the **SET LAUNCH METHOD** screen tap **SmartLoop**.
- 7 Clean and inspect the OTDR port and connectors on the three launch cords.
- 8 Make the connections shown in Figure 80 on page 195.
- 9 Tap **SET**.
- 10 When the **SET LAUNCH COMP** screen shows, make sure the tester shows the correct distances for the end of the launch cord and the start of the tail cord.

Note

*If the fibers have APC connectors, the tester possibly will not find the correct launch and tail events. If this occurs, do the compensation again and select **Manual Entry** to enter the lengths of the cords manually.*

- 11 Tap **SAVE**.

Do the SmartLoop test

- 1 On the home screen, make sure the IDs for the fibers are correct. The tester uses the **Fiber A** ID for the fiber connected to the launch cord at the start of the test.
- 2 Make the connections for **End 1** as shown in Figure 83.

Note

To decrease the wear on the OTDR connector and help keep it clean, use the OTDR port protector (30 cm, 12 in) patch cord provided to connect the OTDR to the launch and tail cords for bi-directional SmartLoop tests.

To reduce the effect of the port protector patch cord on results, do not use a cord longer than 50 cm (20 in).

- 3 Tap **TEST** or press .
- 4 Halfway through the test, the tester tells you to connect the tail cord to the OTDR port. Make the connections for **End 2** as shown in Figure 83, then tap **DONE**.

The tester automatically calculates bi-directional averages of loss measurements and includes the averaged values in the test record.

Caution

Switch the launch and tail connections at the end of the short patch cord. If you switch the connectors at the patch panel, you will possibly get less accurate results for those connections during the second half of the test.

- 5 If **Auto Save** is on, the tester uses the next two IDs to save the results for the two fibers.

If **Auto Save** is off, and you tap **SAVE** or **FIX LATER**, the **SAVE RESULTS** screen shows the next two IDs available. You can change the IDs if necessary.

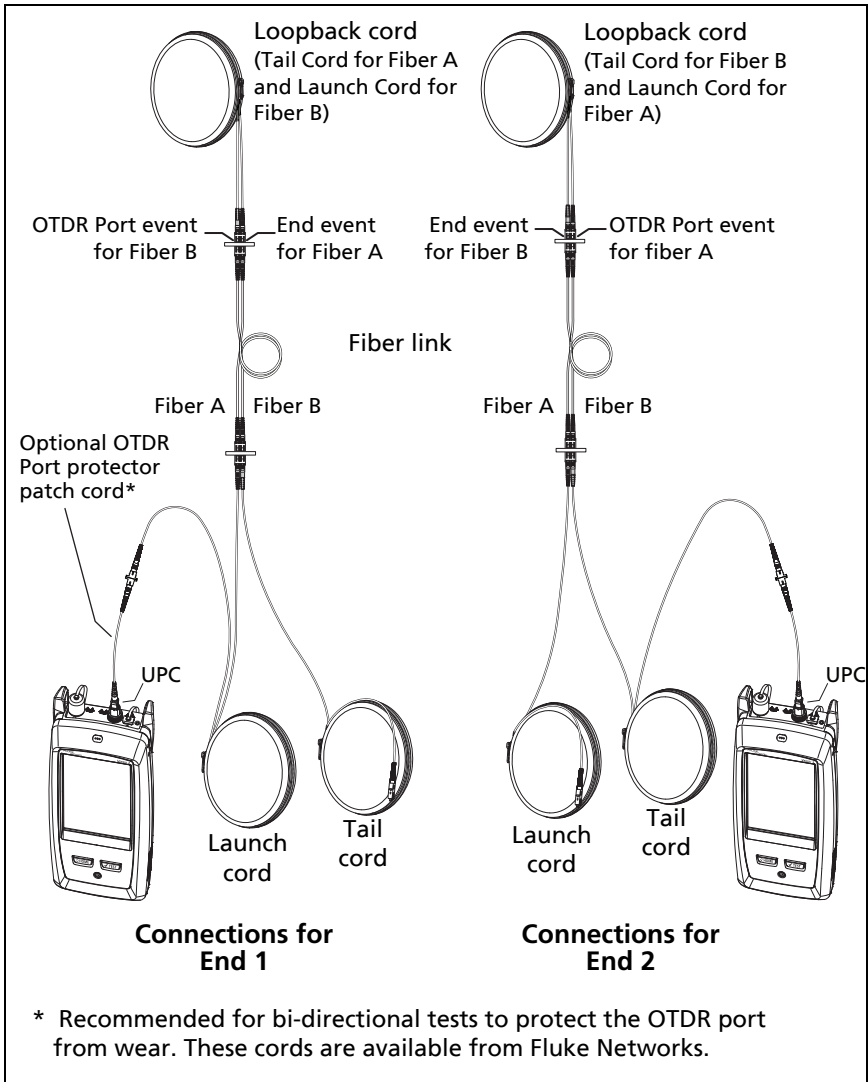

GPU176.EPS

Figure 83. SmartLoop Test Connections for a Bi-Directional Test

Averaged Bi-directional Results

Note

Unless otherwise noted, this section applies to bi-directional results from SmartLoop tests and bi-directional OTDR tests on single fibers.

Figure 84 shows an **EventMap** with averaged results from a bi-directional SmartLoop test.

For averaged results, the tester shows the **EventMap** and the event **TABLE** tabs, but not the **OTDR** tab. The averaged results do not include **Ghost** events.

- For **Hidden** events, the tester calculates the average loss of the event that causes the hidden event, then divides that loss among the events inside the dotted lines. For example, if the average loss of an event is 0.24 dB, and the event causes one event to be hidden, then the average results show 0.12 dB for the event and 0.12 dB for the hidden event.
- For these measurements, the averaged results show the larger or the worst of the two results:
 - Distance between events: larger distance is shown
 - Reflectance: worst value is shown (for example, -30 dB is worse than -40 dB). The reflectance measurements from the unconnected ends are not used in the averaged results.
 - Segment length: larger value is shown
 - Segment attenuation: larger value is shown
 - Fiber length: larger value is shown
 - Overall loss: average value is shown
 - Optical return loss: worse value is shown (for example, 30 dB is worse than 40 dB)
- The **Port Connection Quality** in the averaged results is the rating from End 1.

- The tester does not calculate averaged results in some situations, for example if a launch, tail, or loopback cord was not detected or if the distance to the end was not the same in both directions.

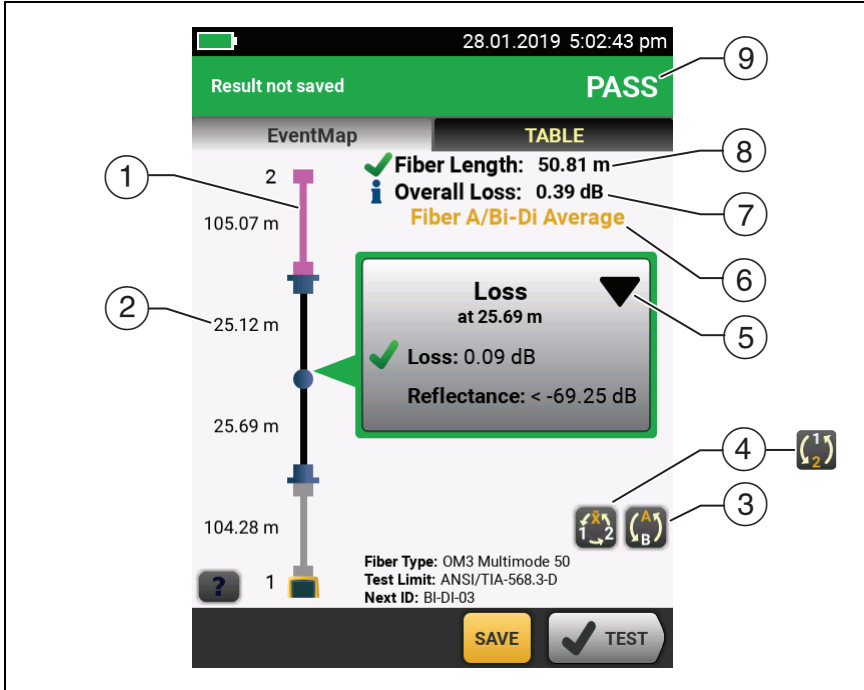



GPU197.EPS

Figure 84. EventMap for Averaged, Bi-directional SmartLoop Results

- The purple fiber is the loopback cord.
- The longest segment length of the two directions.
-  Tap this button to see the results for the other fiber (A or B).

Touch  for 3 seconds to see a summary of the results from ends 1 and 2 on fibers A and B. To see the EventMap for a result in the list, tap the result.

- ④  This button shows with bi-directional SmartLoop results and bi-directional OTDR results from single fibers. Tap this button to see results from each direction (**End 1** or **End 2**) or the averaged results (\bar{X}).
-  This button shows if you do a bi-directional test on a single fiber, but the tester does not calculate averaged results. This can occur for example if the distance to the end was not the same in both directions or if a span was defined when you did the test. Tap this button to see results from each direction (**End 1** or **End 2**). To remove the span definition, tap **Tools**, **Span**, then tap **Delete**.
- ⑤ ▼ The event editing function lets you edit loss events. See “How to Edit a Loss Event” on page 259.
- ⑥ This line shows which results are on the display. Use the selection buttons (④) and (⑤) to see other results.
- ⑦ **Overall Loss:** The average loss of the two directions.
- ⑧ **Fiber Length:** The longest length of the two directions.
- ⑨ **PASS/FAIL:** The overall result for the fibers.
- **PASS:** The averaged results passed. It is possible for one or both directions to have **FAIL** results, while the overall result is **PASS**.
 - **FAIL:** The averaged results failed.

Note

*The tester does not use the bi-directional average results in the calculation for the % **Tested** that shows on the home screen.*

Chapter 8: Use the HDR OTDR



Before you use the tester, read the safety information that starts on page 5.

Overview of Features

The OptiFiber® Pro HDR (High Dynamic Range) Optical Time Domain Reflectometer (OTDR) module attaches to a Versiv and Versiv™ 2 main unit to make a rugged, hand-held tester that lets you locate, identify, and measure reflective and loss events on singlemode fibers in outside plant (OSP) and premises installations. The HDR OTDR test results includes the location and performance of unpowered (passive) splitters used in PON (passive optical network) installations. A typical maximum test range is 260 km for a link with no splitters. The modules includes these features:

- Automatic analysis of OTDR traces and events helps you identify and locate faults on singlemode fiber.
- Shows OTDR results as an intuitive map of events, a table of events, and an OTDR trace. PON OTDR test results include the locations and split ratios of optical splitters.
- Automatic bi-directional averaging gives you more accurate loss measurements than measurements made in one direction.
- Gives a PASS or FAIL result based on a test limit that you specify.
- **Document PON** test limit is available if PASS/FAIL results are not necessary.
- Event editing function lets you edit loss events. See Chapter 9.
- Span function lets you limit OTDR results to a section of fiber that you define. See Chapter 9.

- Touchscreen lets you quickly navigate through different views of the results and see more information about events.
- SmartLoop™ test: One test gives you OTDR results for both fibers in a link.
- DataCenter OTDR™ test gives optimal performance when you do tests on fiber installations that have short links, many connections, and possibly large reflections.
- FaultMap™ test lets you make maps of your cable plant, see patch cords as short as 0.5 m, and see events that have poor reflectance.
- Visual fault locator helps you verify the continuity of fibers and locate faults in fibers and connectors.
- Optional FiberInspector™ video probe lets you inspect fiber endfaces and save the images in test reports.

Connectors, Keys, and LEDs

See Figure 85.

- ① LCD display with touchscreen.
- ② Singlemode OTDR port with an APC (angled physical contact) endface, interchangeable SC adapter and protective cap. The LED in front of the port turns on when the port emits an optical signal.

Caution

Do not connect PC or UPC connectors to the HDR OTDR port. Doing so can damage the port's APC endface, and the large reflection at the OTDR port can cause unreliable test results.

- ③ Visual fault locator port and protective cap. The LED in front of the port turns on when the port emits an optical signal.

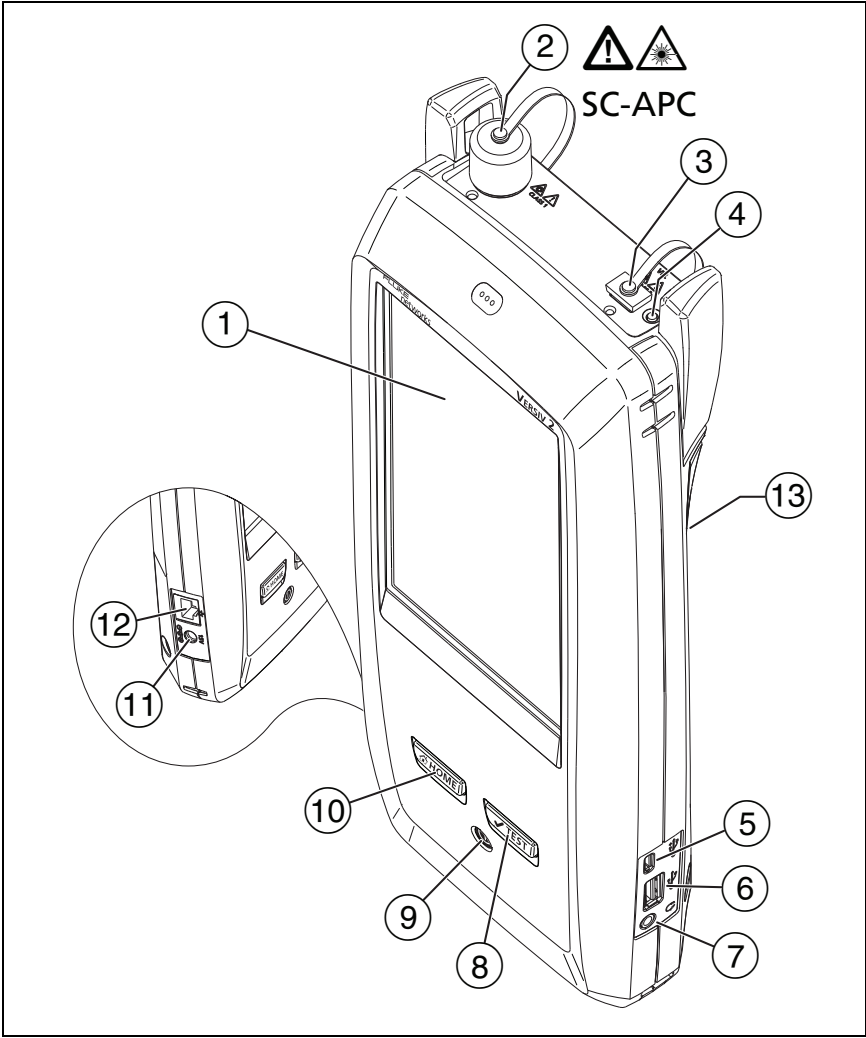





GPU209.EPS

**Figure 85. Connectors, Keys, and LEDs
(Versiv 2 with OFF-200-S1625 OTDR module shown)**

- ④ Button that controls the VFL.



Do not look directly into optical connectors. Some sources emit invisible radiation that can cause permanent damage your eyes.

- ⑤ Micro USB port: This USB port lets you connect the tester to a PC so you can upload test results to the PC and install software updates in the tester.
- ⑥ Type A USB port: This USB host port lets you save test results on a USB flash drive and connect the FI-1000 video probe to the tester. On a Versiv main tester, this port lets you or connect a Wi-Fi adapter for access to the Fluke Networks cloud service LinkWare Live. (Versiv 2 testers have an internal Wi-Fi radio.)
- ⑦ Headset jack.
- ⑧  TEST: Starts a test. To start a test, you can also tap TEST on the display.
- ⑨ : Power button. Versiv 2: The LED in the power button shows the status of the battery charging process. See Table 2 on page 13.
- ⑩ : Press  to go to the home screen.
- ⑪ Connector for the AC adapter. Versiv: The LED is red when the battery charges, and green when the battery is fully charged. The LED is yellow if the battery will not charge. See “Charge the Battery” on page 12.
- ⑫ RJ45 connector: Lets you connect to a network for access to Fluke Networks cloud services.
- ⑬ Decal with laser safety information:



$\lambda = 650\text{nm}$, 0.85mW IEC/EN 60825-1 Complies with 21 CFR 1040.10 and 1040.11 except for deviations pursuant to Laser Notice 50, dated June 24, 2007

How to Remove and Install the Connector Adapters

You can change the connector adapter on the OTDR port of the modules to connect to SC, ST, LC, and FC fiber connectors. You can remove the adapter also to clean the fiber endface in the port. See Figure 86.

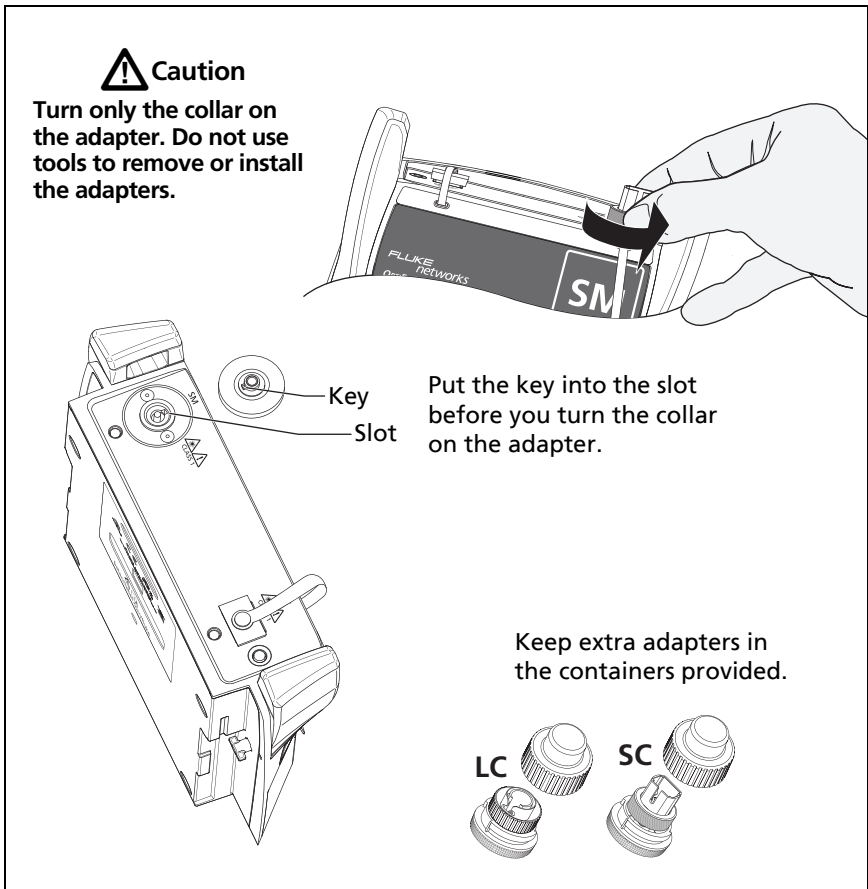

GPU205.EPS

Figure 86. How to Remove and Install the Connector Adapters

The OptiFiber Pro HDR OTDRHome Screen

The home screen (Figure 87) shows important test settings. Before you do a test, make sure these settings are correct.

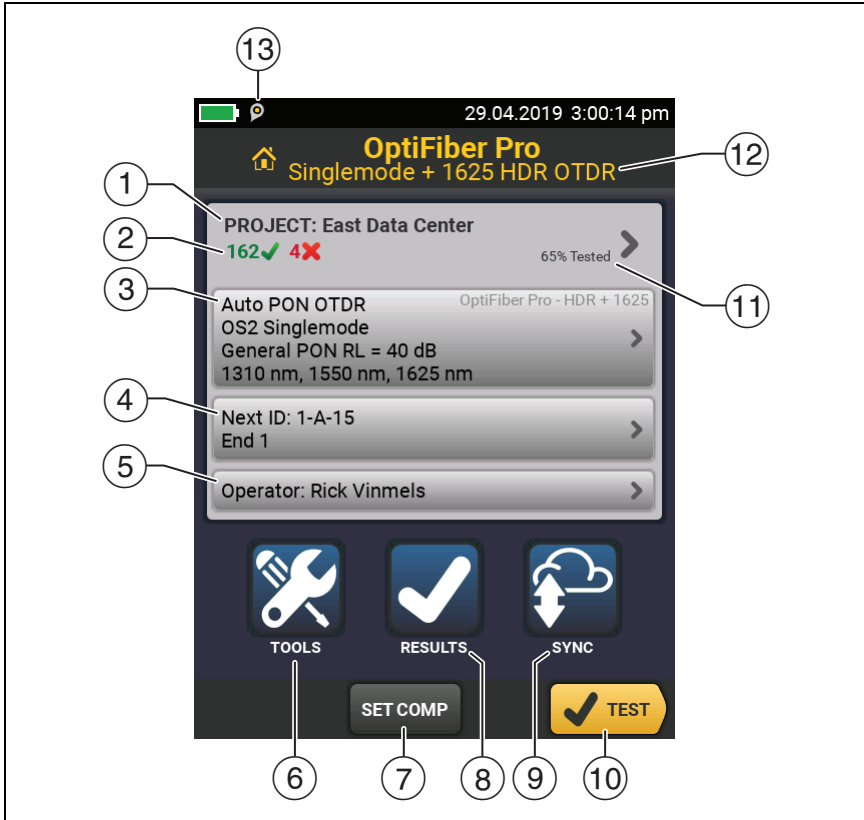



GPU206.EPS

Figure 87. The Home Screen for OptiFiber Pro HDR Modules

- ① **PROJECT:** The project contains the settings for a job and helps you monitor the status of a job. When you save test results, the tester puts them in the project. Tap the **PROJECT** panel to edit the project settings, select a different project, or make a new project.

- ② Shows a summary of the test results in the project:

 : The number of tests that passed.

 : The number of tests that failed.

- ③ The test setup panel shows the settings the tester will use when you tap **TEST** or press .

To change these settings, tap the panel, select the test on the **CHANGE TEST** screen, tap **EDIT**, select different settings on the **TEST SETUP** screen, then tap **SAVE**.

Note

You can set up tests for any module that the tester can use, even when no module is attached.

- ④ **Next ID:** The **Next ID** panel shows the ID that the tester gives to the next test results you save.

Tap **Next ID** to do these tasks:

- Enter an ID, select a different ID in the ID set, select a different set of IDs, or make a new set. The tester adds the IDs and ID sets you make to the project that shows on the home screen.
- Turn **Auto Save** on or off.
- Select **End 1** or **End 2** for OTDR and FiberInspector tests.
- Enter a name for **End 1** and **End 2**.

- ⑤ **Operator:** The name of the person who does the job. You can enter a maximum of 20 operator names. For each operator you can also enter the email address that the operator will use as an ID to sign in to LinkWare Live.

- ⑥ **TOOLS:** The **TOOLS** menu lets you set up the compensation function for the launch/tail cords, use tools such as the real-time trace and the FiberInspector test, see the status of the tester, and set user preferences such as the language and the display brightness.

- ⑦ **SET COMP:** Lets you select a launch method and set the lengths of launch and tail cords. See “About Launch and Tail Cords for OSP Links” on page 220.
- ⑧ **RESULTS:** Tap **RESULTS** to see and manage the results that are saved in the tester.
- ⑨ **SYNC:** Tap **SYNC** to sync projects with LinkWare Live.
- ⑩ **TEST:** Tap **TEST** to do the test shown in the test setup panel. The percentage of the tests in the project that are completed.
- ⑪ **% Tested:** The tester uses the number of available IDs and the tests you selected on the **CABLE ID SETUP** screen to calculate this percentage. See Figure 118 on page 298.

% Tested does not show if your project contains only a **Next ID** list. See “About Next ID Sets” on page 297 for more information about the **Next ID** list.
- ⑫ The type of module attached to the tester. If no module is attached, this screen shows **HOME**.
- ⑬  The asset management icon shows when the owner of a LinkWare Live account has enabled the asset management service on the tester. See “About the Asset Management Service” on page 309.

About PON OTDR Tests

The HDR OTDR’s **Auto PON OTDR** and **Manual PON OTDR** tests have the same settings and results as its **Auto OTDR** and **Manual OTDR** tests, with an additional feature: The PON OTDR tests can identify splitters. The **Auto PON OTDR** test identifies splitters automatically. The **Manual PON OTDR** test lets you use the **SPLITTER SETUP** screen in the **Manual PON OTDR Settings** to specify the split ratios for known splitters on a link. Or, you can use the **DISCOVER** function to locate splitters and identify their ratios.

Note

*If you use the **Manual PON OTDR** test with no splitters specified, and the link has splitters, the tester identifies the splitters as large loss events.*

Settings for HDR OTDR Tests

Table 9 gives descriptions of the settings for OTDR tests.

To set up a project, which includes the settings in Table 9, cable IDs, and operator names, see Chapter 13.

To set up an OTDR test

- 1 On the home screen, tap the test setup panel.
- 2 On the **CHANGE TEST** screen, select an OTDR test to change, then tap **EDIT**.
Or to set up a new OTDR test, tap **NEW TEST** then tap a **Test Type**.
- 3 On the **TEST SETUP** screen, tap the panels to change settings for the test. See Table 9.
- 4 On the **TEST SETUP** screen, tap **SAVE** when your test setup is completed.
- 5 On the **CHANGE TEST** screen, make sure the button next to the test is selected, then tap **USE SELECTED**.

Note

*For all **Test Types** except **FaultMap** and **FiberInspector**, you can use the **SETUP** button on the **TRACE** screen to change some OTDR settings manually after a test. See “How to Quickly Change OTDR Settings After a Test” on page 236.*

Table 9. Settings for HDR OTDR Tests

<p>Module</p>	<p>Select the OTDR module you will use. To select a different module, tap the Module panel on the TEST SETUP screen, then tap a module.</p>
<p>Test Type</p>	<p>When you turn on the tester, the Test Type shows the test that was last selected.</p> <p>Auto PON OTDR: The tester automatically selects settings that give you the best view of the events on PON links. The tester automatically uses the DISCOVER function to locate splitters and identify their ratios. This mode is the easiest to use and is the best choice for most applications. To see the settings the tester used for a test, tap SETUP on the trace screen, then tap CURRENT.</p> <p style="text-align: center;"><i>Note</i></p> <p style="text-align: center;"><i>For links that have splitters with 1:64, 2:64, 1:128, or 2:128 ratios, use a Manual PON OTDR test.</i></p> <p>Manual PON ODTR: This mode lets you select settings to control the test parameters for the trace. You can also enter the ratios of splitters that you know are on the link, or use the DISCOVER function to locate splitters and identify their ratios. If you do not enter splitter ratios, the tester identifies splitters as large loss events. Manual settings are described in this table.</p> <p>Auto OTDR: This is the same as the Auto PON OTDR test, except that the tester does not identify splitters. If the link has splitters, the tester identifies them as large loss events.</p> <p style="text-align: center;"><i>Note</i></p> <p style="text-align: center;"><i>Some unusual faults can cause the Auto OTDR test to show an unsatisfactory trace. If this occurs, use the Manual OTDR test to get a better trace.</i></p> <p>Manual OTDR: This is the same as the Manual PON OTDR test, except that the tester does not identify splitters. If the link has splitters, the tester identifies them as large loss events.</p> <p>See the Technical Reference Handbook.</p> <p style="text-align: right;">-continued-</p>

Table 9. Settings for HDR OTDR Tests (continued)

<p>Test Type (continued)</p>	<p>DataCenter OTDR: This test is optimized for fiber installations that have short links, many connections, and the possibility of large reflections.</p> <p style="text-align: center;"><i>Notes</i></p> <p><i>By default, the DataCenter OTDR test uses 1310 nm for singlemode fiber. This wavelength is typically used in data centers. You can select other wavelengths if necessary.</i></p> <p><i>You must use launch compensation when you do a DataCenter OTDR test.</i></p> <p>FaultMap: The FaultMap test can show connections that do not show on the OTDR EventMap and connections that are poor because they have high reflectance. See “The FaultMap Test” on page 238.</p> <p>SmartLoop OTDR (Auto) and SmartLoop OTDR (Manual): The SmartLoop test lets you connect the far ends of the two fibers in a link so that one OTDR test gives you results for both fibers. The Auto and Manual settings operate the same as for the OTDR test. See “The SmartLoop Test” on page 244.</p> <p>FiberInspector: The FiberInspector test lets you use an optional FI-7000 FiberInspector™ video probe to inspect the endfaces in fiber optic connectors.</p> <p style="text-align: center;"><i>Note</i></p> <p><i>For all Test Types except FaultMap and FiberInspector, you can use the SETUP button on the TRACE screen to change some OTDR settings manually after a test. See “How to Quickly Change OTDR Settings After a Test” on page 236.</i></p>
<p>Manual OTDR Settings</p>	<p>This item shows only if you select Manual OTDR or SmartLoop OTDR (Manual) for the Test Type. Manual OTDR mode lets you select settings to control the test parameters for the trace. See the Technical Reference Handbook.</p>

-continued-

Table 9. Settings for HDR OTDR Tests (continued)

<p>Bi-directional</p>	<p>This setting shows only if you select SmartLoop OTDR (Auto) or SmartLoop OTDR (Manual) for the Test Type.</p> <p>Off: The tester does the SmartLoop test in only one direction.</p> <p>On: The tester does the SmartLoop test in both directions and automatically calculates bi-directional averages of loss. See “Bi-directional SmartLoop Tests” on page 251.</p> <p style="text-align: center;"><i>Note</i></p> <p style="text-align: center;"><i>The tester will not calculate bi-directional averages for test results that include splitters.</i></p>
<p>Launch Compensation</p>	<p>Tap the control to turn the launch compensation function on or off. See “About Launch and Tail Cords for OSP Links” on page 220.</p>
<p>Macrobend Detection (singlemode only)</p>	<p>On: The tester identifies bends. The default threshold for the Auto OTDR test is 0.50 dB. To use a different threshold, select a manual test, then change the setting in the manual settings. This setting is On by default.</p> <p style="text-align: center;"><i>Note</i></p> <p style="text-align: center;"><i>A bend always causes a FAIL result. If you want a PASS result for a link that has a bend, turn off Macrobend Detection.</i></p> <p>Off: The tester does not identify bends. Bends show as loss events in the results.</p>
<p>Wavelength</p>	<p>Select the wavelengths you want to use. You can do tests at one or all of the wavelengths supported by the module you selected.</p> <p style="text-align: center;"> Caution</p> <p style="text-align: center;">To avoid disruption of service, use only 1625 nm when you do tests on live fibers.</p> <p style="text-align: center;"><i>Note</i></p> <p style="text-align: center;"><i>If you use only one wavelength, the Macrobend Detection function will not identify bends.</i></p>

Table 9. Settings for HDR OTDR Tests (continued)

Fiber Type	Select a fiber type that is correct for the type you will test. To see a different group of fiber types, tap MORE , then tap a group.
Fiber Type Settings	<p>IR: The tester uses the index of refraction to calculate the optical length of the fiber. Each fiber type includes the value specified by the manufacturer. To use a different IR, make a custom fiber type. See the Technical Reference Handbook.</p> <p>Backscatter: Backscatter is the backscatter coefficient. The tester uses this value to calculate the reflectance of events for OTDR tests and the overall ORL for the link. Each fiber type includes the value specified by the manufacturer. To use a different backscatter value, make a custom fiber type. See the Technical Reference Handbook.</p>
Test Limit	Select the correct test limit for the job. Generic limits, such as General PON and Document PON , let you do tests when no industry-standard limit is applicable and you do not want to make a custom limit. These limits are in the Miscellaneous group. To see a different group of limits, tap MORE , then tap the name of a group. Some test limits use the measured length of the fiber to calculate a limit for loss.
Test Limit Settings	This item shows only if the selected test limit calculates a loss limit for each link. For such limits, enter the number of connectors and splices in the link. See the Technical Reference Handbook.

About Launch and Tail Cords for OSP Links

Launch and tail cords are often not necessary for OTDR tests on outside plant installations. This is because most of the insertion loss and return loss of long links is caused by the fiber. The connectors on the ends of a long link add very little to the total losses, so it is often not necessary to use launch and tail cords to include the losses of those connectors in the results.

You should however keep a patch cord connected to the OTDR port. Use the patch cord, with an adapter if necessary, to connect the OTDR to links. The patch cord protects the module's connector from the wear caused by repeated connections to the OTDR port.

It may be necessary to use launch and tail cords in these situations:

- The OSP link is short, and you need to see events near the beginning or end of the fiber.
- The tester cannot find the end of an unconnected fiber that has an APC connector. This can occur because APC connectors cause very small reflections. OTDRs expect a large reflection at the end of a fiber, so sometimes the OTDR will not find the end of a fiber. In this situation, connect an APC/UPC tail cord or a patch cord to the APC connector to cause a large reflection at the end of the fiber.
- The customer's requirements specify the use of launch and tail cords.

If you must use launch and tail cords, you can use the tester's launch compensation function to remove the losses, lengths, and attenuation coefficients of the launch and tail cords from overall OTDR results. The compensation function does not remove the losses of the connections at the launch and tail cords.

To use the launch compensation function

- 1 On the home screen, tap **SET COMP**.
- 2 Select a launch method, make the connections shown on the screen, then tap **SET**.

When you use launch and tail cords that have APC connectors, it is possible that the tester will not find the connectors when you try to set up the launch compensation function. If this occurs, enter the lengths of the launch and tail cords manually.

For details on the launch compensation function, see “How to Set Up the Launch Compensation Function” on page 166.

OTDR Port Connection Quality

When you do an OTDR test, the test shows the quality of the OTDR port connection (Figure 88). If a test takes more than approximately 3 seconds, the **PROGRESS** screen also shows a preview of the OTDR trace. The trace is black for one wavelength and blue for the other wavelength.

If the Gauge is Not in the Good Range

- Clean the OTDR port and the fiber connector. Use a video probe to inspect the endfaces in the port and fiber connector for scratches and other damage. If an endface on the tester shows damage, contact Fluke Networks for service information.
- If the gauge stays outside the **Good** range, remove the adapter from the module and inspect the adapter for damage. Make sure that the white plastic ring inside the center tube shows no damage.

A poor OTDR connection increases the dead zone at the connector. The dead zone can hide faults that are near the OTDR connector.

A poor connection also decreases the strength of the signal from the OTDR. The weaker signal causes more noise on the trace, which can cause the OTDR to miss events. It also decreases the dynamic range.

When the test is completed, the quality gauge shows in the details for the **OTDR Port** event on the EventMap screens. The tester includes the gauge with the test results you save.

Port Connection Quality for SmartLoop Tests

For SmartLoop tests, the **OTDR Port** connection for the second fiber is the input connector of the loopback cord. See Figures Figure 101 on page 249 and Figure 103 on page 254. If the tester shows a message about the connection quality of the OTDR port,

but the OTDR connection on the tester is good, inspect the ends of the loopback cord.

“STOP” Button for Manual Tests

When a trace shows on the **PROGRESS** screen for a manual OTDR test with multiple wavelengths, you can tap the **STOP** button to stop the OTDR test at the current wavelength and start the test at the next wavelength (Figure 88). This lets you control the time the tester takes to give OTDR results. You can stop the test to get results more quickly, but the results are possibly less accurate.

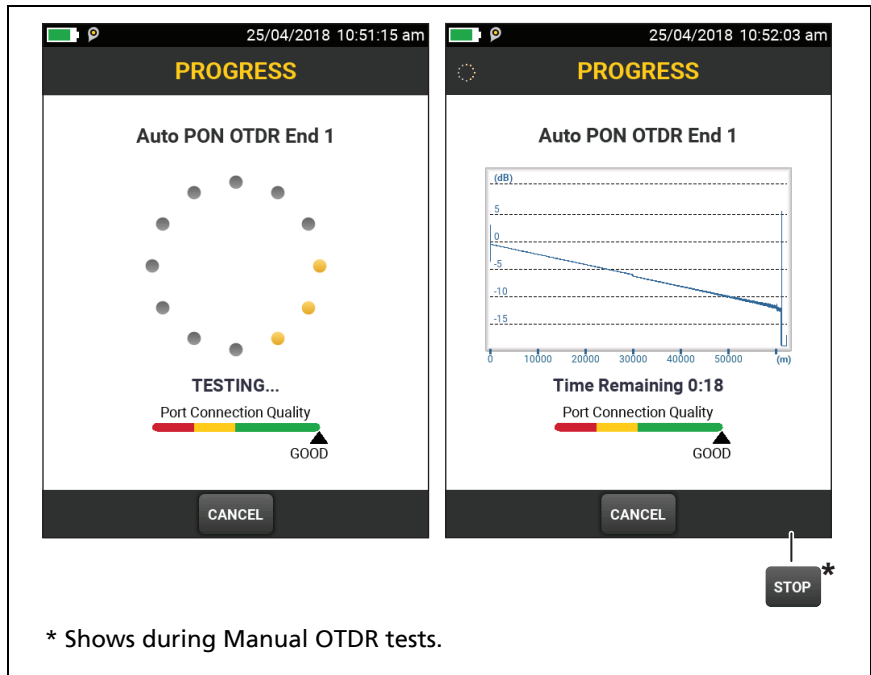

Figure 88. The OTDR Port Connection Quality Gauge and Progress Screen

How to Do an HDR OTDR Test

Figure 89 shows the equipment for HDR OTDR tests.

To do an OTDR test

- 1 Make sure that the home screen shows the correct settings for the job.
- 2 Clean and inspect the connectors on the launch and tail cords and the fiber to be tested.
- 3 Connect the tester to the link as shown in the Figures:
 - Figure 90 shows the connections for **PON OTDR** tests on OSP links where you typically do not use launch or tail cords.
 - Figure 91 shows connections that include launch and tail cords.
- 4 Tap **TEST** or press .

Notes

If the tester does not find the end of the fiber, connect an APC/UPC tail cord or a patch cord to the APC connector to cause a large reflection at the end of the fiber.

The tester shows a warning if there is an optical signal on the fiber.

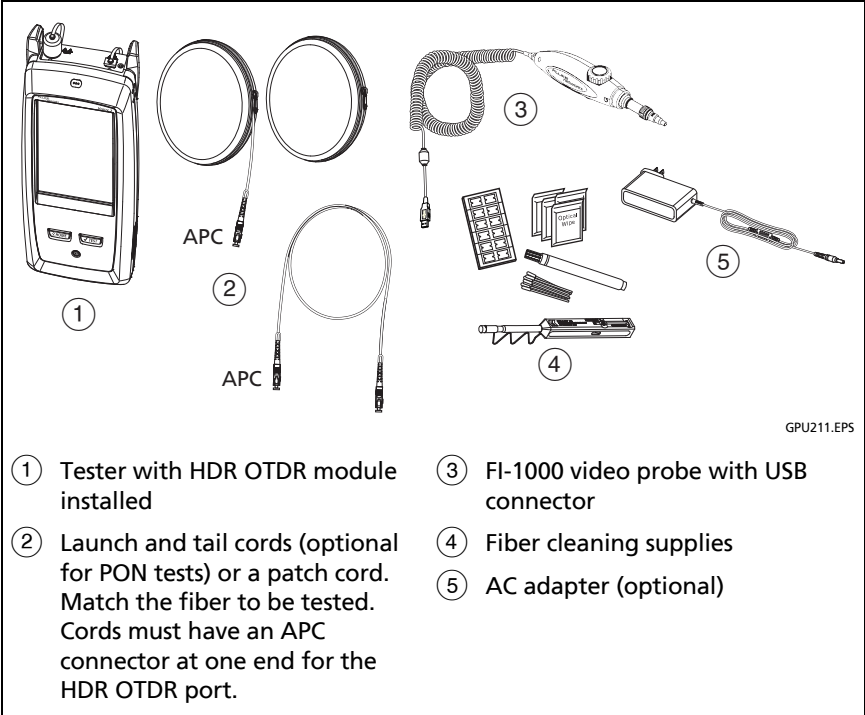

⚠ Caution

Do not connect PC or UPC connectors to the HDR OTDR port. Doing so can damage the port's APC endface, and the large reflection at the OTDR port can cause unreliable test results.

Figure 89. Equipment for HDR OTDR Tests

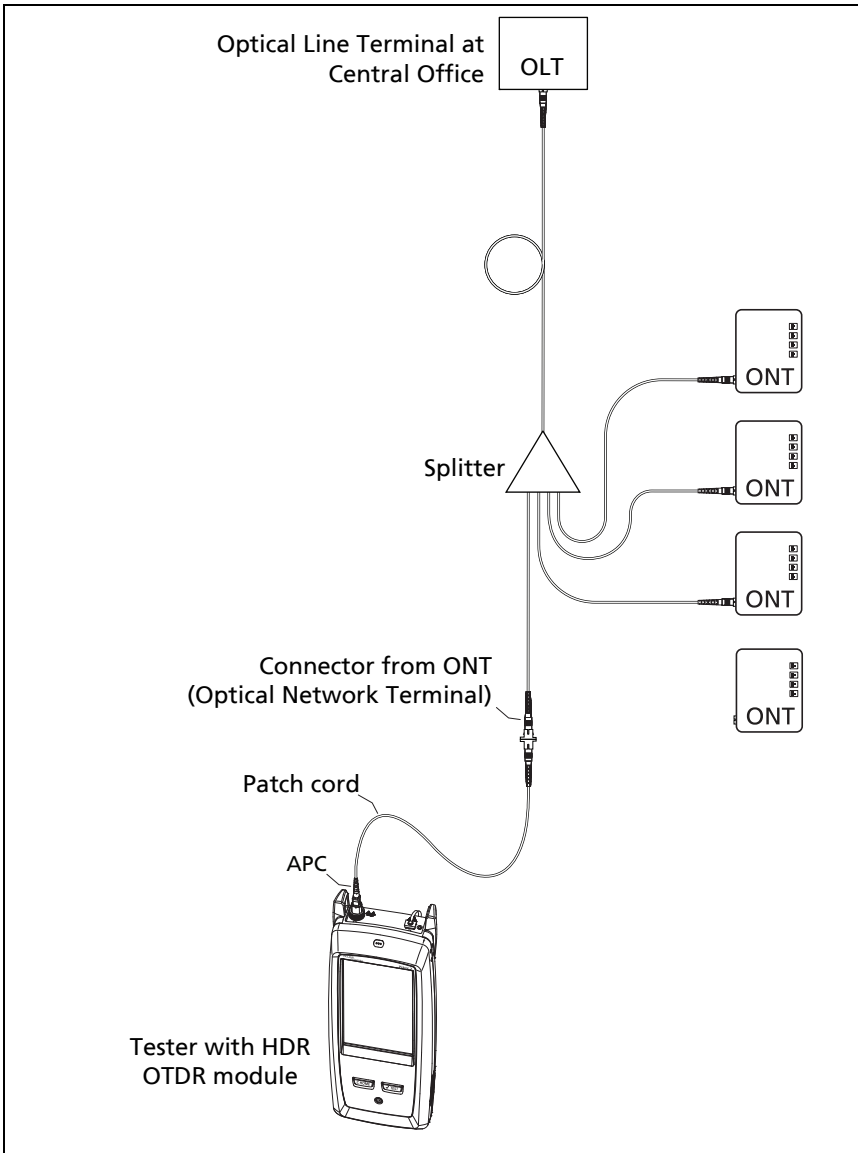

GPU213.EPS

Figure 90. Typical Connections to an Out-of-Service PON Link

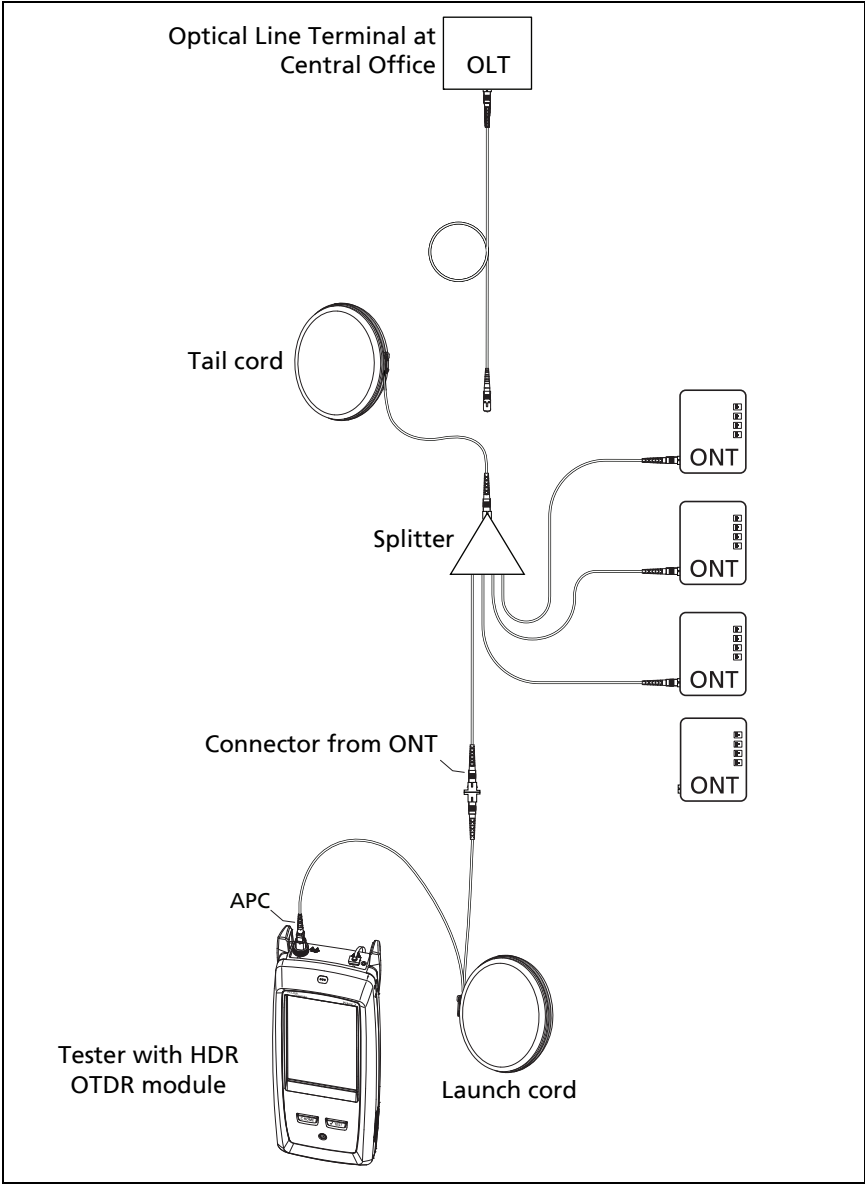

GPU214.EPS

Figure 91. HDR OTDR Connected with Launch and Tail Cords

HDR OTDR Results

Notes

The tester shows measurements with ">" or "<" when the actual value is possibly more or less than the value shown. For example, this can occur for hidden events or for measurements that are out of the range of the tester.

*When a test is completed, the type of screen the tester shows first (**EventMap**, **TABLE**, or **TRACE**) is the type you looked at last.*

EventMap

Notes

The EventMap combines the results for all wavelengths used for the test. If an event on the EventMap does not show on the event table or OTDR trace, change the wavelength on the OTDR screen.

The EventMap does not show ghosts.

See Figure 92.

- ① The ID for the results. If **Auto Save** is off, **Result not saved** shows.
- ② The end of the fiber.

: Launch and tail cords and their connectors show in gray. The map shows these if **Launch Compensation** is on and the cords are connected.

- ③ The length of the fiber segment between two events.
- ④ Icons show events on the fiber:

Reflective events:

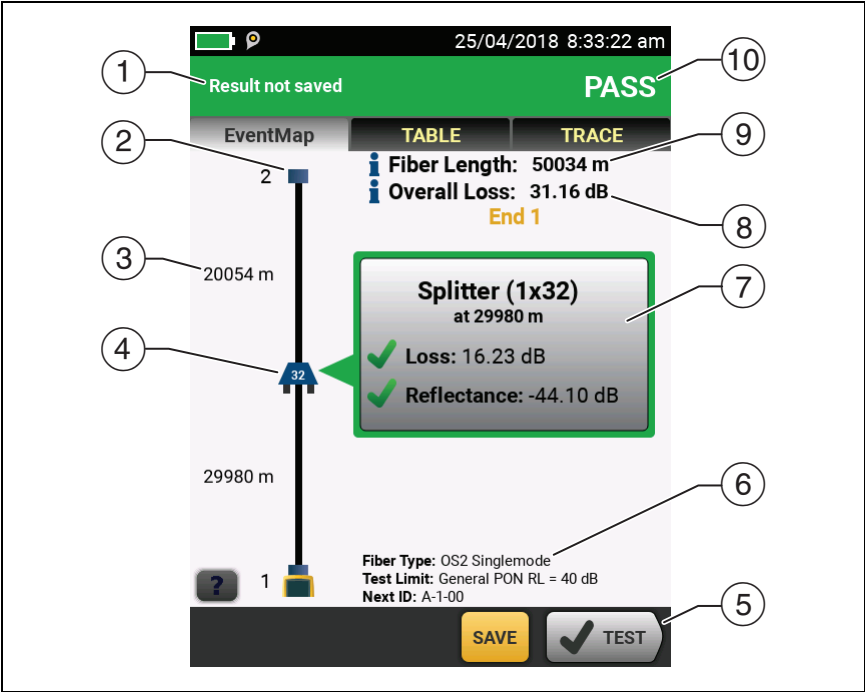

GPU208.EPS

Figure 92. EventMap for an HDR OTDR Test Result

: A reflective event, which is usually a non-APC connector. Measurements for the event are all within the test limits.

: One or more measurements for the event exceeds the limit. This event could also be a **Ghost Source**.

Non-reflective loss events:

: A splitter. The number on the splitter shows the split ratio.

: An APC connector or a splice. Measurements for the event are all within the test limits. If **Macrobend Detection** is **Off**, this

could be a bend. If the event is a bend, and **Macrobend Detection** is **On**, the EventMap shows the bend icon. If the event has negative loss, it is a **Gainer**.



: One or more measurements for the event exceeds the limit.



: A bend with loss that exceeds a macrobend threshold. If **Macrobend Detection** is **Off**, the EventMap shows the blue circle shown above.

Note

*A bend always causes a **FAIL** result. If you want a **PASS** result for a link that has a bend, turn off **Macrobend Detection**.*

Hidden events:



: The event is hidden by a previous event.

The map shows a dotted line around hidden events and the event that causes them to be hidden. The tester combines the loss of all the events that are in the dotted line. To see the combined loss, tap the event that causes the hidden event.

(4). The tester does not show loss measurements for hidden events.



: The event is hidden by a previous event. The reflectance of the event exceeds the limit. This icon shows only when the test limit has a limit for reflectance.



: The cause of the hidden event. The loss of the second connector is hidden in the attenuation dead zone of the first connector.

- (5) When more than one button shows at the bottom of the screen, the tester highlights one in yellow to recommend which one to tap.

- ⑥ The fiber type and test limit the tester used for the test, and the ID the tester will use for the next results that you save.
- ⑦ When a test is completed, the window shows information for the event that has the worst measurement. The information windows show the worst results of the wavelengths used for the test.

If the window border is green, the measurements for the event do not exceed the limits.

If the window border is red, a measurement exceeds the limits.

If the window border is blue, the tester does not give a pass or fail result to the event because it cannot do a full analysis of the event. This occurs for **OTDR Port**, **Hidden**, and **End** events. This occurs for all events if you use the **Document PON** test limit because **Document PON** does not have values for limits.

When you use a test limit that has a reflectance limit, **Hidden** events show a fail status if their reflectance exceeds the limit.

: The measurement exceeds the limit.

: The measurement is within the limit.

To see details for the event, tap the window.

To see information for another event, tap another icon on the map.

Note

Events before the launch cord connector and after the tail cord connector do not have a pass or fail status.

- ⑧ **Overall Loss:** The loss of the cabling. This does not include the OTDR connection and the loss of the last event. If **Launch Compensation** is on, the overall loss includes the launch and tail connectors, but not the launch and tail fibers.

If you did the test at two wavelengths, the tester shows the highest loss of the two wavelengths.

N/A shows for the **Overall Loss** if the tester cannot measure the loss. This can occur when events are too close together or when there is a large reflective event near the end of the fiber.

- ⑨ **Fiber Length:** The length of the fiber. The units show in meters (**m**) or feet (**ft**). If **Launch Compensation** is on, the length does not include the length of the launch and tail cords.
- ⑩ **PASS/FAIL:** The overall result for the fiber.
 - **PASS:** All measurements are within the test limits.
 - **FAIL:** One or more measurements exceed the limit.

Event Table

The event table shows a list of the events on the fiber. To see the event table, tap **TABLE** on the OTDR results screen. Figure 93 shows an example of an event table.

- ① To see details for an event, tap the event in the table. Scroll the table if necessary to see all the events.
 - **(ft)** or **(m)**: The distance to the event
 - **LOSS:** The loss of the event.
 - **REFLECT:** The reflectance of the event.
 - **TYPE:** The event type.

Notes

*The **OTDR Port** and **End** events always show **N/A** for loss because backscatter measurements are not available on both sides of those events.*

*If an event shows “---” in the **LOSS** and **REFLECT** columns, the tester did not find the event at the selected wavelength. Tap an arrow button (⑤) to see the measurements for the other wavelength.*



- ② Tap  to see help for this screen.

- ③ **OVERALL:** Tap this button to see overall measurements of length, loss, and optical return loss for the fiber.



GPU222.EPS

Figure 93. Event Table from an HDR OTDR Test

- ④ When more than one button shows at the bottom of the screen, the tester highlights one in yellow to recommend which one to tap.
- ⑤ If the tester made measurements at two wavelengths, tap the arrow buttons to see results for the other wavelength. Possibly, some events show only at one wavelength.
- ⑥ : The measurement is within the limit.
- : The measurement exceeds the limit.



: The tester does not give a pass or fail result to the event. This occurs for **OTDR Port**, **Hidden**, and **End** events. This occurs for all events if you use the **Document PON** test limit because **Document PON** does not have values for limits.

When you use a test limit that has a reflectance limit, **Hidden** events show a **FAIL** status if their reflectance exceeds the limit.

To see details for an event, such as limits for measurements and the **SEGMENT ATTENUATION** coefficient, tap the event in the table.

HDR OTDR Trace

To see the OTDR trace, tap **TRACE** on the OTDR results screen. Figure 94 shows an example of an OTDR trace.

- ① The decibel scale shows the level of backscatter. The tester sets the backscatter level at the start of the trace to approximately 0 dB.
- ② The measurement cursor. To measure loss and distance, tap the yellow circle so that **MARK** shows, drag the cursor to the start of the measurement, tap **MARK**, then drag the cursor to the end of the measurement.
- ③ When the cursor is on an event, this area shows the event type. The text is green if the event passed, red if the event failed, or black if there is no limit for measurements. The event type does not show after you tap **MARK** to use the measurement cursor.
- ④ Tap  to see help for this screen.
- ⑤ Tap **SETUP** to change the **RANGE**, **PULSE WIDTH**, **AVERAGING TIME**, and wavelengths for the test. See “How to Quickly Change OTDR Settings After a Test” on page 236. You can also see the settings used on the test.
- ⑥ Tap  or  to move the cursor to another event.

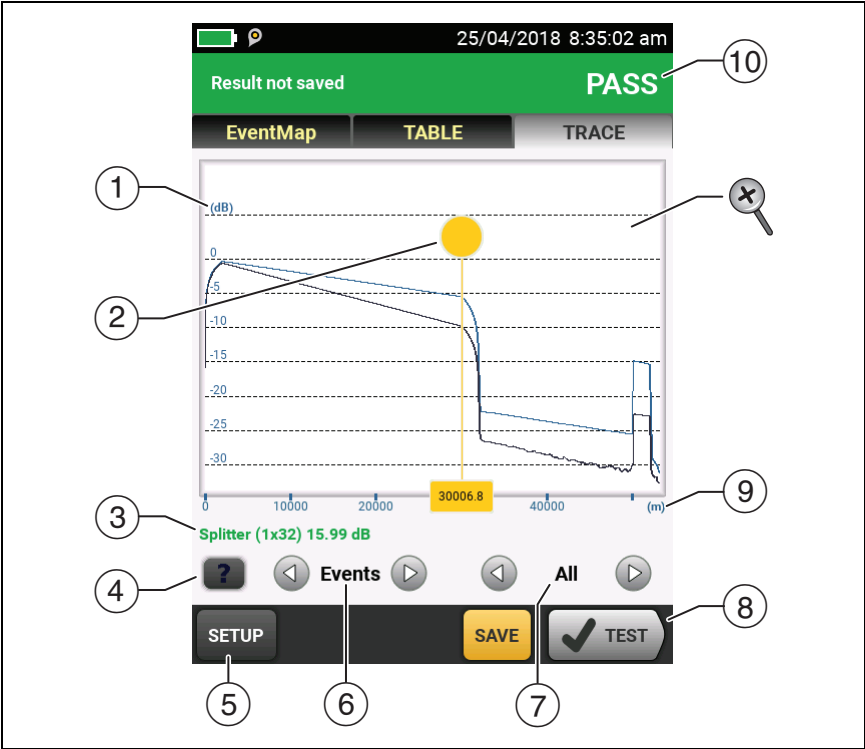

GPU223.EPS

Figure 94. HDR OTDR Trace

- ⑦ The wavelength the tester used for the test. If the tester used more than one wavelength, tap ◀ or ▶ to see the other wavelength. Possibly, some events show only at one wavelength. You can select wavelengths on the **TEST SETUP** screen.
- When **All** shows, the screen shows the traces for all wavelengths.
- ⑧ When more than one button shows at the bottom of the screen, the tester highlights one in yellow to recommend which one to tap.
- ⑨ The distance scale shows the distance along the fiber.

- ⑩ **PASS:** All measurements were within the limits.
- FAIL:** One or more measurements exceeded its limit.
-  To zoom in and out, use the pinch, reverse-pinch, and double-tap gestures on the touchscreen. You can also use the zoom controls to change the magnification on the distance and decibels scales independently.

How to Quickly Change OTDR Settings After a Test

After an OTDR test, you can quickly change some OTDR settings when you want to try different settings on the same fiber. After you do a test, tap **SETUP** on the **TRACE** screen, then select settings on the **MANUAL PON OTDR** (Figure 95) or **MANUAL OTDR** screen.

You can save your settings to the **Active** test setup or to a **New** test setup, or you can tap **TEST** to do a test without saving the settings.

- ① Tap the settings you want. You can scroll some columns to see more settings. For descriptions of the settings, see the Technical Reference Handbook.
- ② Select the wavelengths to use for the test.
- ③ Tap **CURRENT** to see the settings the tester used for the last test.
- ④ The **SAVE SETUP** button lets you save your settings:

Active: The tester saves the settings in the active test setup. If the test was not a **Manual** test, the tester changes the active **Test Type** to **Manual**.

New: The tester saves the settings in a new test setup that is added to the project. The new setup is a **Manual PON OTDR test** or a **Manual OTDR test**.

If you save your settings in a new test setup:

The tester uses your settings until you save the results or exit the results screen then start a test from the home screen.

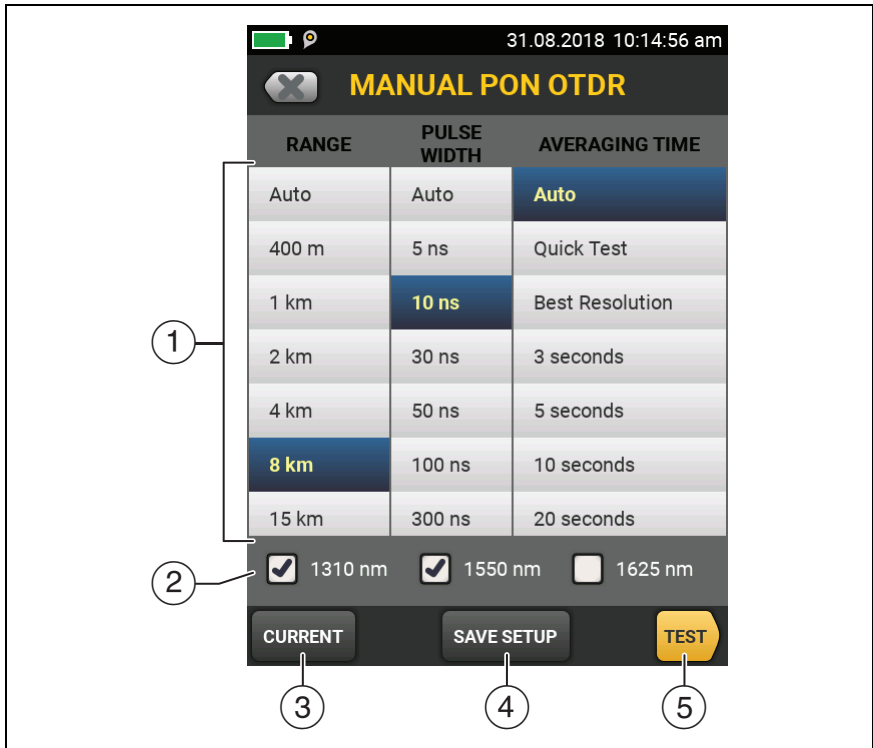

GPU221.EPS

Figure 95. Manual PON OTDR Screen for Quick Changes After a Test

Then the tester uses the test setup it had before you changed the settings.

If you do not save your settings:

The tester uses your settings until you save the results or exit the results screen then start a test from the home screen. Then the tester uses the test setup it had before you changed the settings.

- 5 Tap **TEST** or press TEST to do a test with the settings you selected.

The **PROGRESS** screen shows **Manual OTDR** when the tester uses your settings.

Note

If you want to use your settings when you are finished with this test, make sure you save them. See item ④.

The FaultMap Test

The FaultMap test helps you record the connections in a fiber link and identify bad connections. It can show short patch cords and find connections that have high reflectance. The FaultMap test gives you these results:

- Shows a map of the connectors in the link that possibly do not show on the OTDR EventMap. The map includes connectors that are hidden in the dead zones made by previous events. The FaultMap test shows patch cords as short as 0.5 m for lengths < 2 km.
- Shows connections that are poor because they have high reflectance (> -35 dB).
- Reflective events that are apparently not connectors do not show on the FaultMap diagram. Loss events, including bends and splitters, are also not shown.

The FaultMap test finds events that have a reflectance larger than approximately -60 dB on singlemode fiber. (More negative values mean less reflectance and a better connection. For example, a connector with a reflectance of -40 dB is better than one with -35 dB.)

Notes

Since the FaultMap test finds only reflections, do not use it to look for fusion splices or angled physical contact (APC) connectors.

*FaultMap results do not include a **PASS/FAIL** status. The results are only for your documentation of the link.*

FaultMap tests on singlemode fiber usually take more time than OTDR tests. The test uses very

narrow pulses on singlemode fiber to make the smallest event dead zones possible, and does more analysis on the reflections in the link.

How to Do the FaultMap Test

Notes

The FaultMap test does not use the launch compensation settings.

The FaultMap test uses the wavelength that gives the best results.

Figure 96 shows the equipment for the FaultMap test.

- 1 Clean and inspect the connectors on the launch and tail cords or patch cords and the link to be tested.
- 2 Connect the launch cord to the OTDR port and the link to be tested, as shown in Figure 97. Connect a tail cord to the far end of the link if necessary.

Or, you can use a patch cord that is 1 m long at minimum to connect the tester to the link. To see results for the far-end connector, connect a tail cord or patch cord (>1 m) to the far end of the link.

- 3 On the home screen, tap the test setup panel.
- 4 On the **CHANGE TEST** screen, tap the button next to the **FaultMap** test, then tap **USE SELECTED**. If a FaultMap test is not available, tap **NEW TEST** to add one to the project.
- 5 Tap **TEST** or press **TEST**.

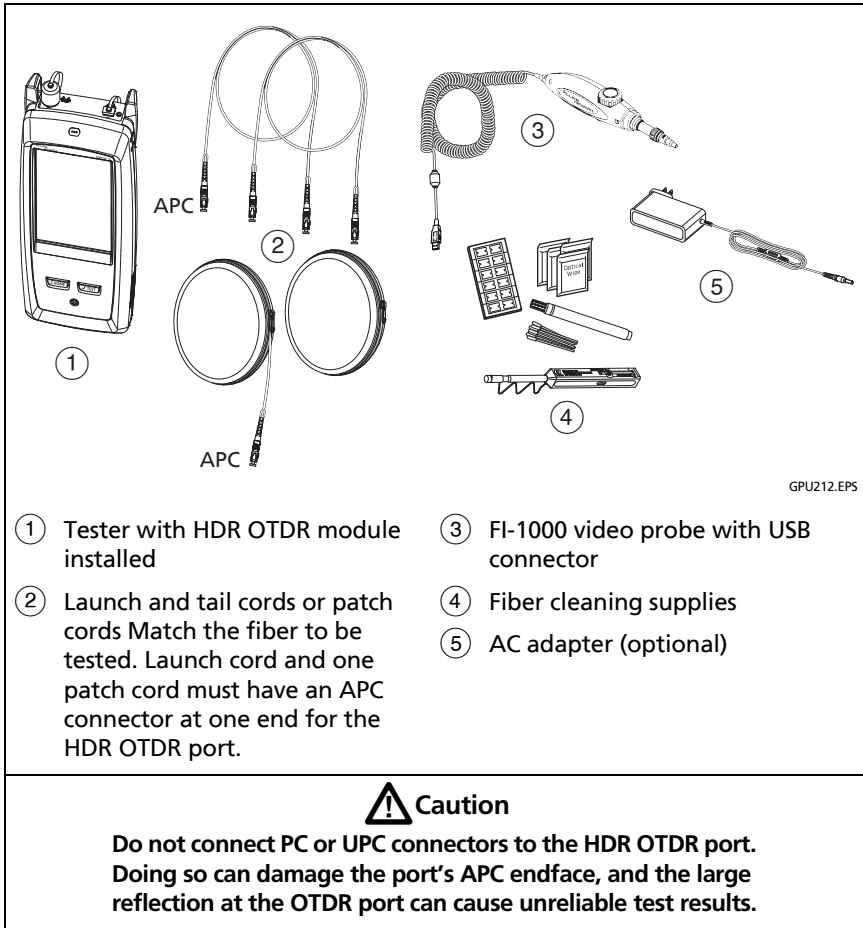

Figure 96. Equipment for FaultMap Tests

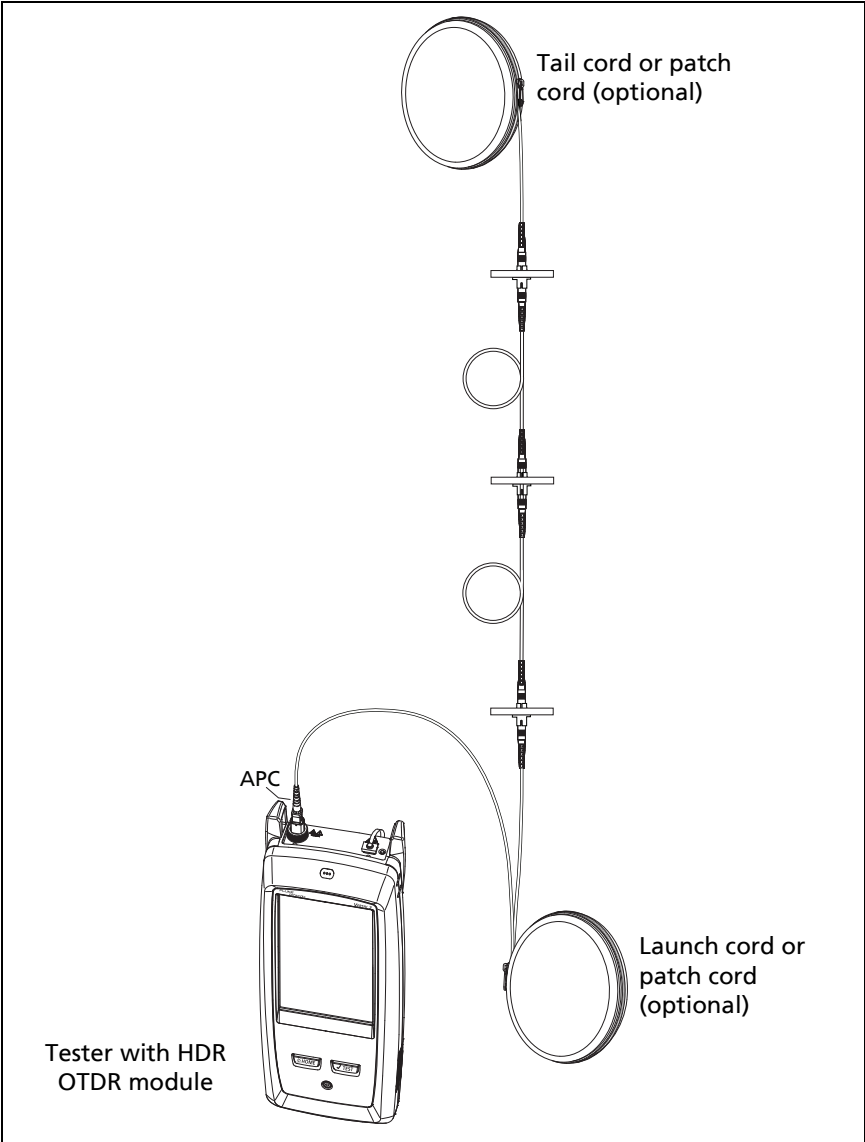
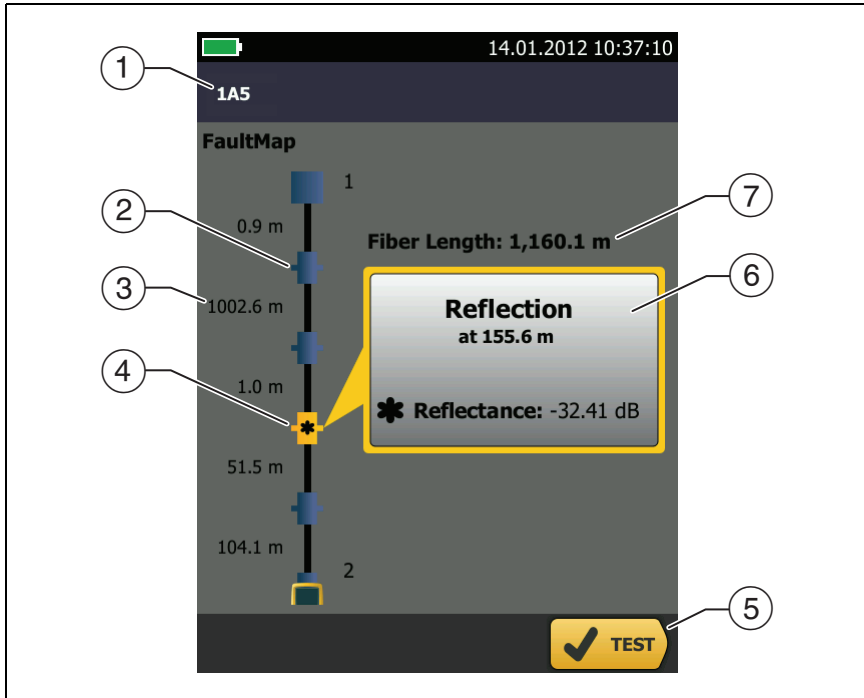

Figure 97. FaultMap Test Connections

GPU215.EPS

FaultMap Screen





GPU15.EPS

Figure 98. FaultMap Screen

Note

The FaultMap test does not use the launch compensation settings. The results show the launch and tail cords and their connectors in the same colors as other cords and connectors.

- ① The ID for the results. If **Auto Save** is off, **Result not saved** shows.
- ② : An event that has a reflectance smaller than -35 dB.
- ③ The length of the fiber segment between two events.

- ④ : An event that has a reflectance larger than -35 dB. It is possibly a connector that is dirty, poorly polished, scratched, cracked, misaligned, unseated, worn, or the wrong type.

: The arrow icon shows when there are more events that do not show on the screen. To see the events, tap the icon or scroll the screen.
- ⑤ When more than one button shows at the bottom of the screen, the tester highlights one in yellow to recommend which one to tap.
- ⑥ If the window is blue, the reflectance of the event is smaller than -35 dB. If the window is orange, the reflectance is larger than -35 dB.

To see the window for another event, tap another icon on the fiber.
- ⑦ **Fiber Length:** The length of the fiber. This includes the lengths of the launch and tail cords, if you used them.

The SmartLoop Test

The SmartLoop test lets you connect the far ends of the two fibers in a link and do one OTDR test to get separate results for each fiber.

You use a launch cord to connect the fibers together at the far end of the link. When you do the SmartLoop test, the tester uses the launch compensation settings to remove the effects of the loopback cord and its connectors.

The Auto and Manual settings for the SmartLoop test operate the same as for the OTDR test. See Table 9 on page 216.

Figure 99 shows the equipment for the SmartLoop test.

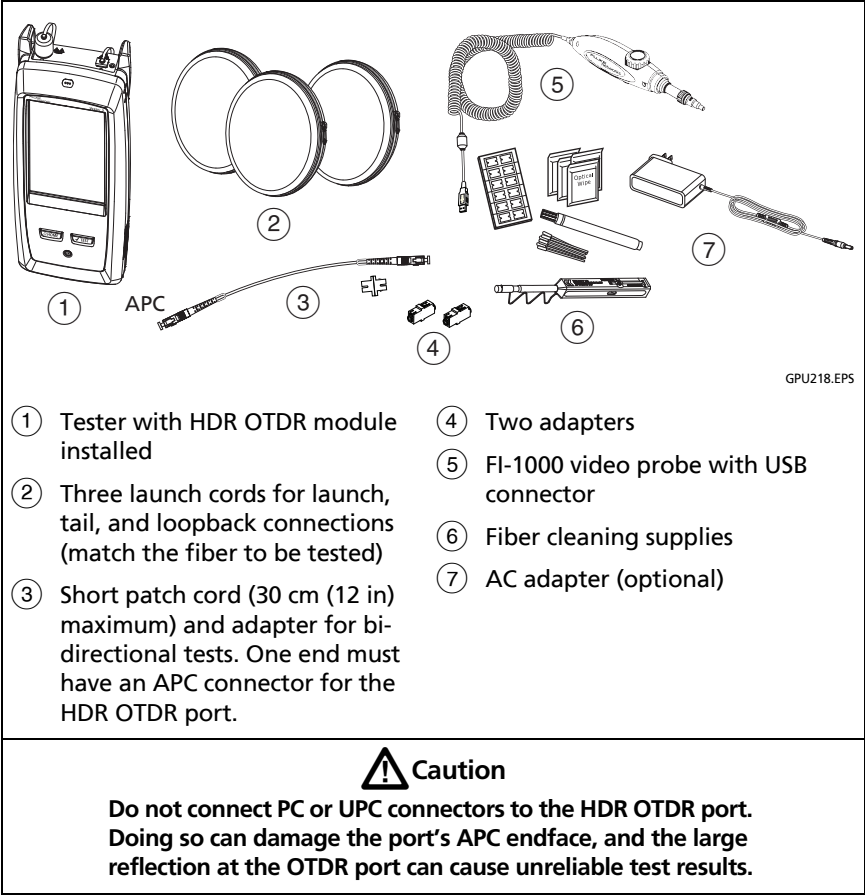

Figure 99. Equipment for SmartLoop Tests

How To Do an Auto SmartLoop Test

Set up the launch compensation function

- 1 On the home screen, tap the test setup panel.
- 2 On the **CHANGE TEST** screen, tap the button next to the Auto SmartLoop test, then tap **USE SELECTED**.

If an Auto SmartLoop test is not available, tap **NEW TEST** to add one to the project. Select settings as necessary on the **TEST SETUP** screen. See “Settings for HDR OTDR Tests” on page 216.

- 3 Select three launch cords that have the same type of fiber as the fiber you will test.
- 4 On the home screen, tap **SET COMP**.
- 5 On the **SET LAUNCH METHOD** screen tap **SmartLoop**.
- 6 Clean and inspect the OTDR port and connectors on the three launch cords.
- 7 Make the connections shown in Figure 100.
- 8 Tap **SET**.
- 9 When the **SET LAUNCH COMP** screen shows, make sure the tester shows the correct distances for the end of the launch cord and the start of the tail cord.

Note

*If the fibers have APC connectors, the tester possibly will not find the correct launch and tail events. If this occurs, do the compensation again and select **Manual Entry** to enter the lengths of the cords manually.*

- 10 Tap **SAVE**.

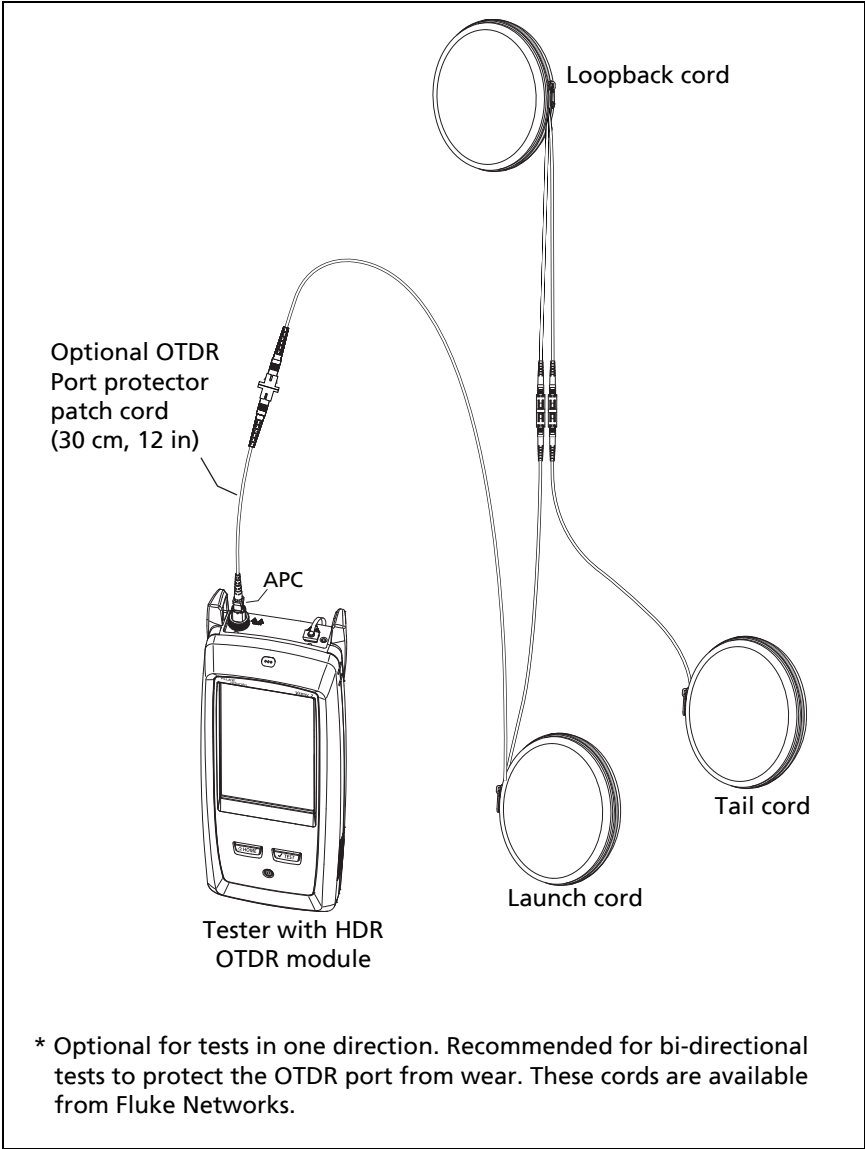

GPU216.EPS

Figure 100. SmartLoop Launch Compensation Connections

Do the SmartLoop test

- 1 Make the connections shown in Figure 101.
- 2 On the home screen, make sure the IDs for the fibers are correct. The tester uses the **Fiber A** ID for the fiber connected to the launch cord.
- 3 Tap **TEST** or press TEST.

Note

If the tester shows a message about the connection quality of the OTDR port, but the OTDR connection on the tester is good, inspect the ends of the loopback cord. See “Port Connection Quality for SmartLoop Tests” on page 222.

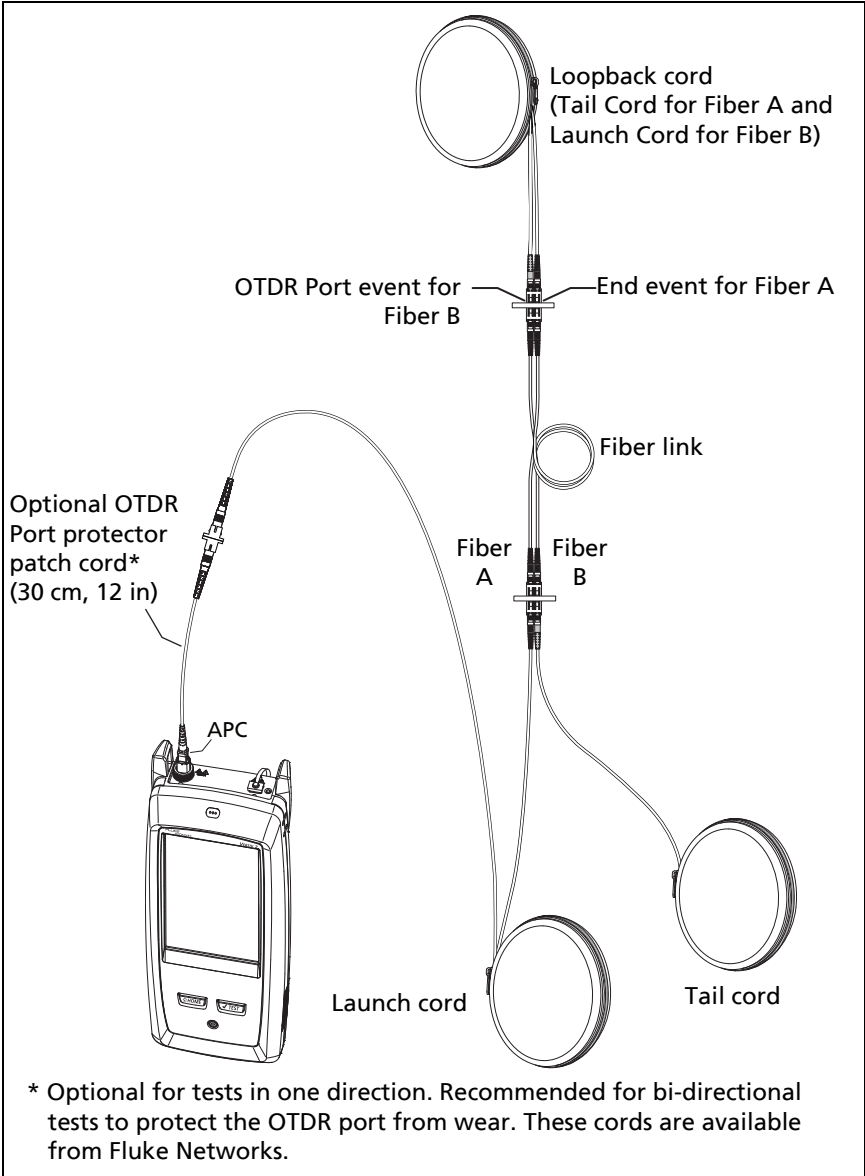

GPU217.EPS

Figure 101. SmartLoop Test Connections

SmartLoop Results

The tester shows the SmartLoop results on two sets of **EventMap**, **TABLE**, and **TRACE** screens, one for each fiber in the link. See Figure 102.

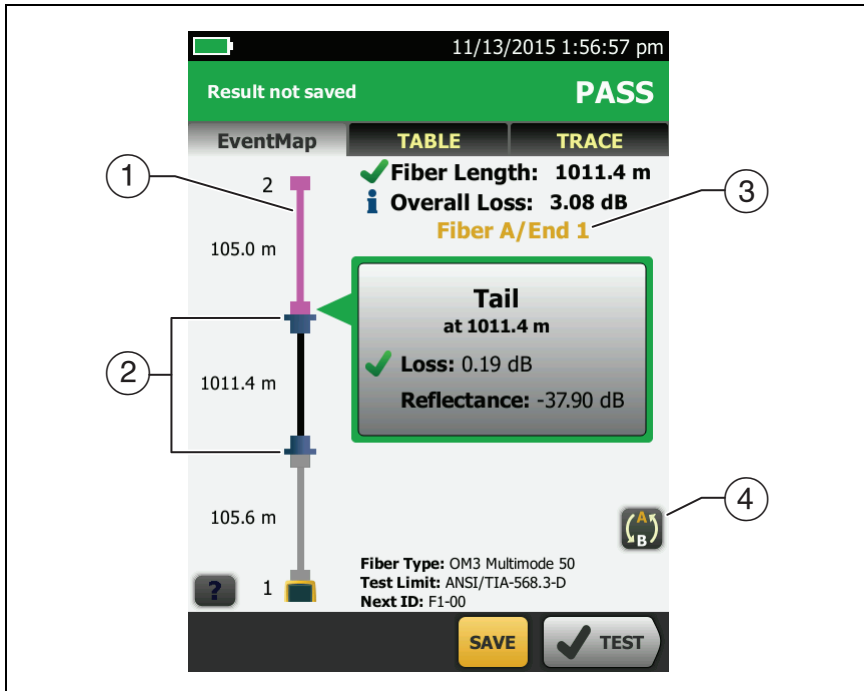

GPU172.EPS

Figure 102. EventMap from a SmartLoop Test

- ① The purple fiber is the loopback cord.
- ② The fiber between the launch cord and the loopback cord is the fiber on one side of the link.
- ③ **Fiber A** is the side of the link connected to the OTDR at **End 1**.
- ④ To switch between results for fibers A and B, tap  on the EventMap screen.

Note

When you save SmartLoop results, the tester saves the results in two records, one for each fiber in the link.

Bi-directional SmartLoop Tests

OTDR tests from both ends of a fiber can give different results because some properties of fiber and fiber components can cause differences in the loss measurements in each direction.

For example, the loss of an event is the difference between the backscatter levels before and after the event. If a segment after a connector or splice has a higher backscatter value than the segment before, the tester shows different values of loss for the connector or splice from the two directions.

For splices, which have very little loss, the difference in the backscatter of the two fibers can cause an apparent gain in power across the splice in one direction.

For this and other reasons, bi-directional averages of connector and splice loss in both directions are more accurate than measurements from one direction.

The bi-directional SmartLoop test gives you bi-directional OTDR results for both fibers in a link. The tester also automatically calculates averages of the two results and includes the averaged values in the test record.

Note

The tester will not calculate bi-directional averages for test results that include splitters.

How to Do a Bi-directional SmartLoop Test

Set up the launch compensation function

- 1 On the home screen, tap the test setup panel, make sure the correct SmartLoop test is selected on the **CHANGE TEST** screen, then tap **EDIT**.

If an Auto SmartLoop test is not available, tap **NEW TEST** to add one to the project. Select settings as necessary on the **TEST SETUP** screen. See "Settings for HDR OTDR Tests" on page 216.
- 2 On the **TEST SETUP** screen, in the **Bi-directional** panel, tap the control to make it show **On**, then tap **SAVE**.
- 3 On the **CHANGE TEST** screen, tap **USE SELECTED**.
- 4 Select three launch cords that have the same type of fiber as the fiber you will test.
- 5 On the home screen, tap **SET COMP**.
- 6 On the **SET LAUNCH METHOD** screen tap **SmartLoop**.
- 7 Clean and inspect the OTDR port and connectors on the three launch cords.
- 8 Make the connections shown in Figure 100 on page 247.
- 9 Tap **SET**.
- 10 When the **SET LAUNCH COMP** screen shows, make sure the tester shows the correct distances for the end of the launch cord and the start of the tail cord.

Note

*If the fibers have APC connectors, the tester possibly will not find the correct launch and tail events. If this occurs, do the compensation again and select **Manual Entry** to enter the lengths of the cords manually.*

- 11 Tap **SAVE**.

Do the SmartLoop test

- 1 On the home screen, make sure the IDs for the fibers are correct. The tester uses the **Fiber A** ID for the fiber connected to the launch cord at the start of the test.
- 2 Make the connections for **End 1** as shown in Figure 103.

Note

To decrease the wear on the OTDR connector and help keep it clean, use an OTDR port protector (30 cm, 12 in) patch cord to connect the OTDR to the launch and tail cords for bi-directional SmartLoop tests. These cords are available from Fluke Networks.

To reduce the effect of the port protector patch cord on results, do not use a cord longer than 50 cm (20 in).

- 3 Tap **TEST** or press .
- 4 Halfway through the test, the tester tells you to connect the tail cord to the OTDR port. Make the connections for **End 2** as shown in Figure 103, then tap **DONE**.

The tester automatically calculates bi-directional averages of loss measurements and includes the averaged values in the test record.

Caution

Switch the launch and tail connections at the end of the short patch cord. If you switch the connectors at the patch panel, you will possibly get less accurate results for those connections during the second half of the test.

- 5 If **Auto Save** is on, the tester uses the next two IDs to save the results for the two fibers.

If **Auto Save** is off, and you tap **SAVE** or **FIX LATER**, the **SAVE RESULTS** screen shows the next two IDs available. You can change the IDs if necessary.

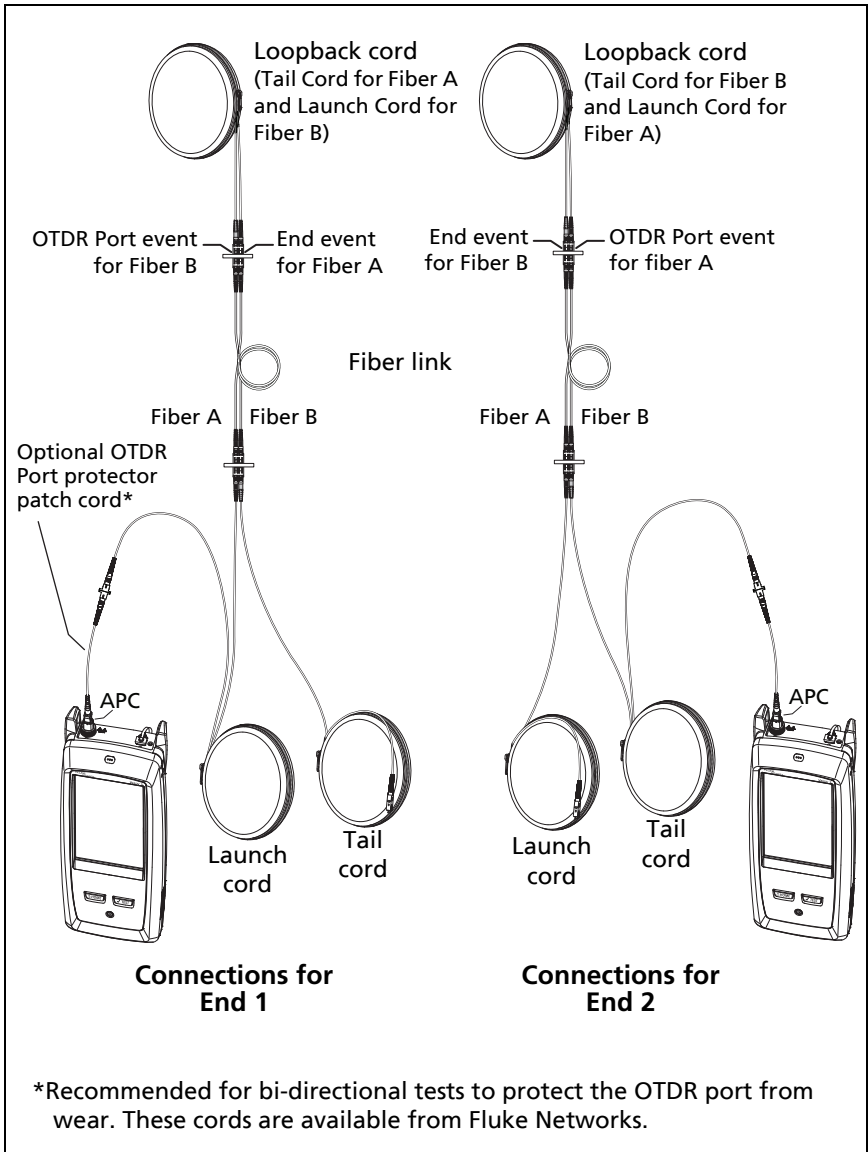

GPU219.EPS

Figure 103. SmartLoop Test Connections for a Bi-Directional Test

Averaged Bi-directional Results

Note

Unless otherwise noted, this section applies to bi-directional results from SmartLoop tests and bi-directional OTDR tests on single fibers.

Figure 104 shows an **EventMap** with averaged results from a bi-directional SmartLoop test.

For averaged results, the tester shows the **EventMap** and the event **TABLE** tabs, but not the **OTDR** tab. The averaged results do not include **Ghost** events.

- For **Hidden** events, the tester calculates the average loss of the event that causes the hidden event, then divides that loss among the events inside the dotted lines. For example, if the average loss of an event is 0.24 dB, and the event causes one event to be hidden, then the average results show 0.12 dB for the event and 0.12 dB for the hidden event.
- For these measurements, the averaged results show the larger or the worst of the two results:
 - Distance between events: larger distance is shown
 - Reflectance: worst value is shown (for example, -30 dB is worse than -40 dB). The reflectance measurements from the unconnected ends are not used in the averaged results.
 - Segment length: larger value is shown
 - Segment attenuation: larger value is shown
 - Fiber length: larger value is shown
 - Overall loss: average value is shown
 - Optical return loss: worse value is shown (for example, 30 dB is worse than 40 dB)
- The **Port Connection Quality** in the averaged results is the rating from End 1.

- The tester does not calculate averaged results in some situations, for example if a launch, tail, or loopback cord was not detected or if the distance to the end was not the same in both directions.

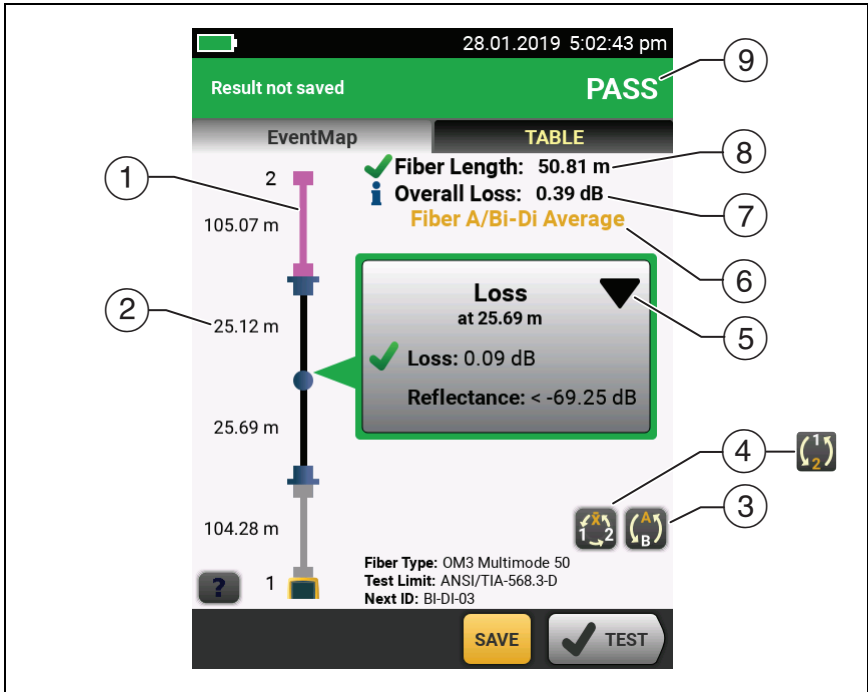



GPU197.EPS

Figure 104. EventMap for Averaged, Bi-directional SmartLoop Results

- ① The purple fiber is the loopback cord.
- ② The longest segment length of the two directions.
- ③  Tap this button to see the results for the other fiber (A or B).

Touch  for 3 seconds to see a summary of the results from ends 1 and 2 on fibers A and B. To see the EventMap for a result in the list, tap the result.

- ④  This button shows with bi-directional SmartLoop results and bi-directional OTDR results from single fibers. Tap this button to see results from each direction (**End 1** or **End 2**) or the averaged results (\bar{X}).
-  This button shows if you do a bi-directional test on a single fiber, but the tester does not calculate averaged results. This can occur for example if the distance to the end was not the same in both directions or if a span was defined when you did the test. Tap this button to see results from each direction (**End 1** or **End 2**). To remove the span definition, tap **Tools**, **Span**, then tap **Delete**.
- ⑤  The event editing function lets you edit loss events. See “How to Edit a Loss Event” on page 259.
- ⑥ This line shows which results are on the display. Use the selection buttons (④) and (⑤) to see other results.
- ⑦ **Overall Loss:** The average loss of the two directions.
- ⑧ **Fiber Length:** The longest length of the two directions.
- ⑨ **PASS/FAIL:** The overall result for the fibers.
- **PASS:** The averaged results passed. It is possible for one or both directions to have **FAIL** results, while the overall result is **PASS**.
 - **FAIL:** The averaged results failed.

Note

*The tester does not use the bi-directional average results in the calculation for the % **Tested** that shows on the home screen.*

Chapter 9: Use the OTDR Span and Event Editing Functions

Overview of Features

The span and event editing functions are available in the OptiFiber Pro and OptiFiber Pro HDR modules:

- The span function lets you limit OTDR results to a section of fiber that you define.
- The event editing function lets you edit loss events.

How to Edit a Loss Event

When you know that a **Loss** event is an APC connector, you can tap ▼ in the event's information window, then use the **Change Event Type** menu to change the event's type to **APC Connector**. See Figure 105. You can also change an edited event back to a **Loss** event.

Note

When you edit an event, the test result does not show that you made a change.

*When you use a test limit for the OptiFiber Pro module: If you change a **Loss** event to an **APC Connector**, the tester uses 0.75 dB as the loss limit for the connector. That is a standard loss limit for connectors in inside-plant applications. If you must use a different limit for APC connectors, make a custom test limit.*

PASS/FAIL Result for Edited Events

When you change a loss event's type, the tester changes the loss limit for the event and recalculates the event's results and the overall results. The recalculations can possibly change the **PASS/FAIL** results. For example (refer to Figure 105):

- You test a link and see a **Loss** event that has a loss of 0.53 dB. This causes a **FAIL** result because the limit for a loss event is 0.30 dB.
- You change the event to an **APC Connector**. Because the selected test limit has a loss limit of 0.75 dB for connectors, the result for the event changes to a **PASS**
- If the loss event was the only **FAIL** result on the link, the overall result will also change from **FAIL** to **PASS**.

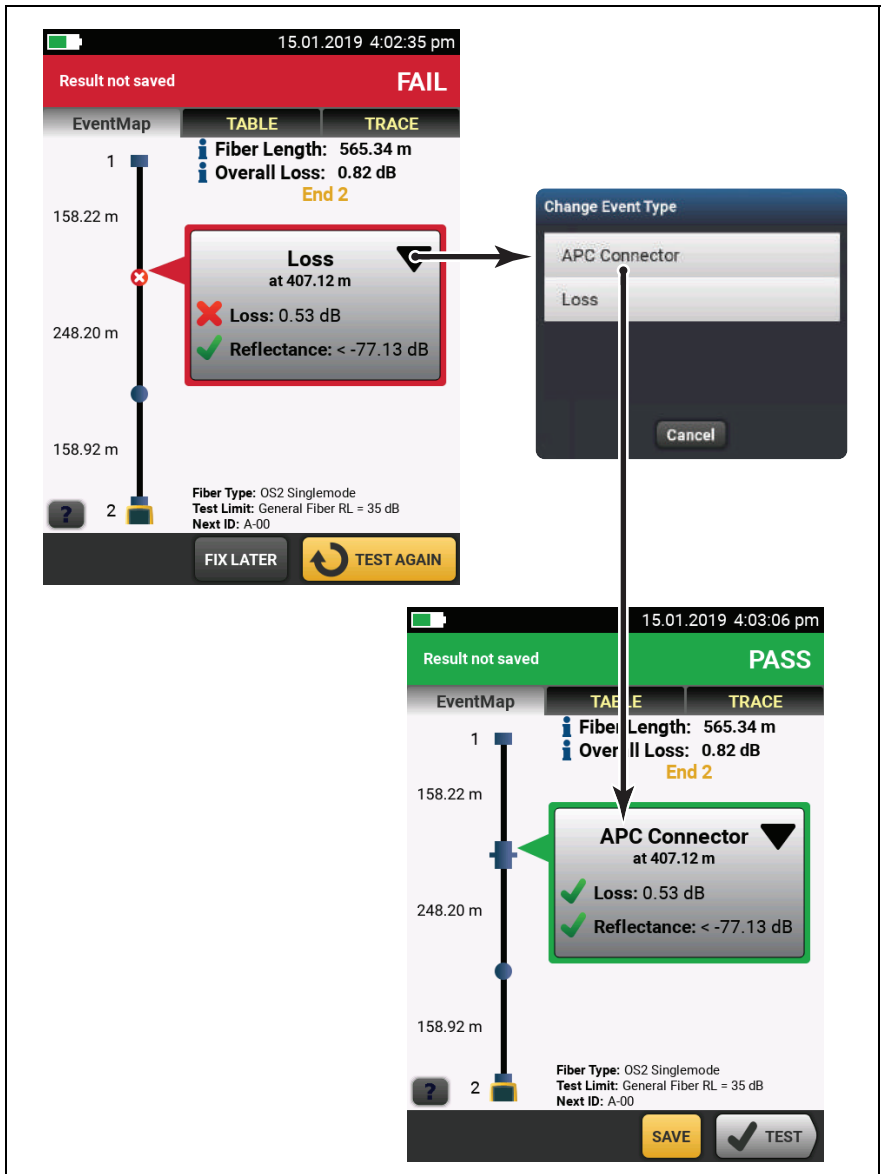

Figure 105. How to Edit a Loss Event

Editing Events in Bi-directional Results

When you edit an event in a bi-directional result, the tester copies your change to the result you got from the other end and to the averaged result. The tester copies your change to these events:

- **Loss**
- **Reflection**
- **Gainer**
- **Ghost Source**
- **Hidden**

In some situations, the tester will not copy your change:

- The tester will not copy your change to events not listed above, such as **Launch**, **Tail**, and **Bend** events.
- The tester will not copy your change if it did not calculate averaged bi-directional results. This can occur, for example, if you did the **End 1** and **End 2** tests with different wavelengths or if a span was defined when you did the test.
- The tester will not copy your change to the results from the other end if there was not an event at the correct location. But the change will show in the averaged results.

Other Options for Editing Events

Use LinkWare PC to make these edits to events:

- Change an event to a splice, APC connector, or splitter.
- Add a 0 dB event to a trace where a splice or APC connector is present but has very low loss and does not show in the event table.
- Add a note to any event.

- Delete an event that has a loss of 0.35 dB or less. You can do this to remove small loss events that are not caused by a splice or APC connector. This makes the results show only the actual components in a link.

To edit events in LinkWare PC

Use the buttons on the **Events** tab in the full-sized **OTDR Trace Viewer** window. See the LinkWare PC online help for details.

How to Use the Span Function

The **Span** function on the **TOOLS** menu lets you get test results from a section of fiber that you define. For example, if one segment had a break and was spliced, you can do an OTDR test on the entire link, but make the test record show results for only the spliced segment.

You define the span before you do OTDR tests. The tester gives you results for only the span until you clear the span settings.

If you will test multiple links of different lengths, and must make sure that all spans include the end of the link, you can set the **Span Stop** location to a point beyond the end of the longest link.

When the Tester Will Not Use Your Span Settings

- The tester will not use your span settings if **Launch Compensation** is **On**.
- The tester will not use your span settings if you do a SmartLoop test because that test always uses **Launch Compensation**.

How to Define a Span

- 1 Tap **TOOLS**, then tap **Span**.
- 2 On the **SPAN** screen, tap **Set**.
- 3 On the **SET SPAN DISTANCE** screen, tap **Span Start** and **Span Stop** to define the span.
- 4 On the **SET SPAN DISTANCE** screen, tap **SAVE**.

How to Do a Test with Your Span Settings

- 1 Turn off **Launch Compensation**:
 - a. On the home screen, tap the test setup panel.
 - b. On the **CHANGE TEST** screen, tap **EDIT**.
 - c. On the **TEST SETUP** screen, set **Launch Compensation** to **Off**.
 - d. Tap **SAVE**, then tap **USE SELECTED**.
- 2 Do an OTDR test. Figures 106, 107, and 108 show OTDR results for a span.

Bi-directional Tests with Span Settings

When you use span settings with a bi-directional test:

- If you want the span to include the same section of fiber from both ends, be sure to change the span settings when you do the test from the other end. For example, a fiber is 300 m long, and the **Span Start** and **Span Stop** are 0 m and 100 m for **End 1**. To get results for the same section of fiber from **End 2**, set the **Span Start** and **Span Stop** to 200 m and 300 m.
- If you define a span, then do a bi-directional test on a fiber, you can see the results from both ends of the fiber, but the tester does not calculate averaged bi-directional results. See item ④ in Figure 84 on page 204.

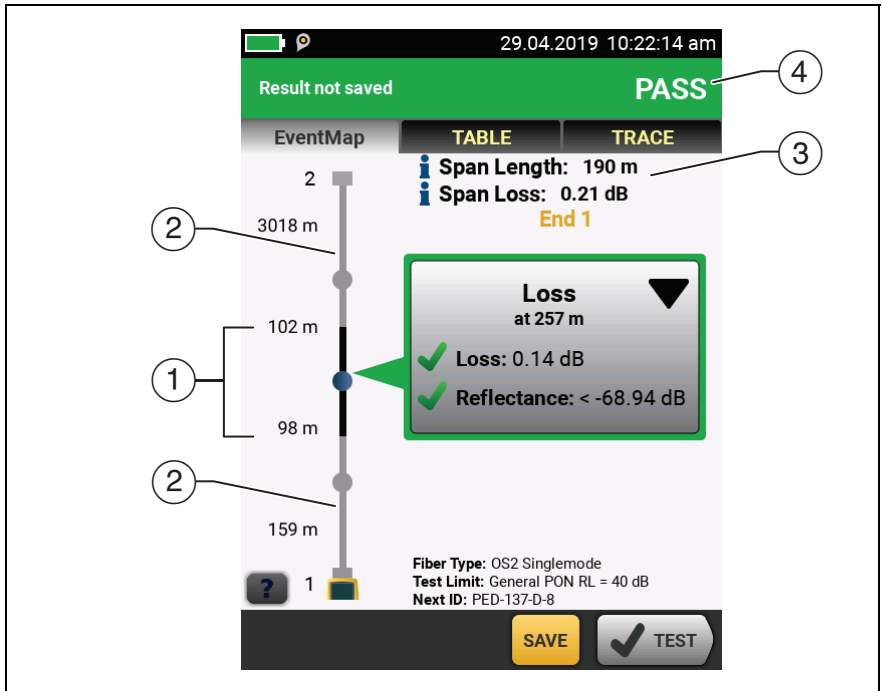

GPU233.EPS

Figure 106. EventMap for a Span

- ① The black section is the span defined by the **Span Start** and **Span Stop** locations. The span area shown is not to scale.
The distances show the lengths of segments between events, as on an **EventMap** with no span defined.
- ② The fiber outside of the span is gray. Measurements outside of the span do not have **PASS/FAIL** results.
- ③ The length and overall loss of the span.
- ④ **PASS**: All measurements in the span were within the limits.
FAIL: One or more measurements in the span exceeded its limit.

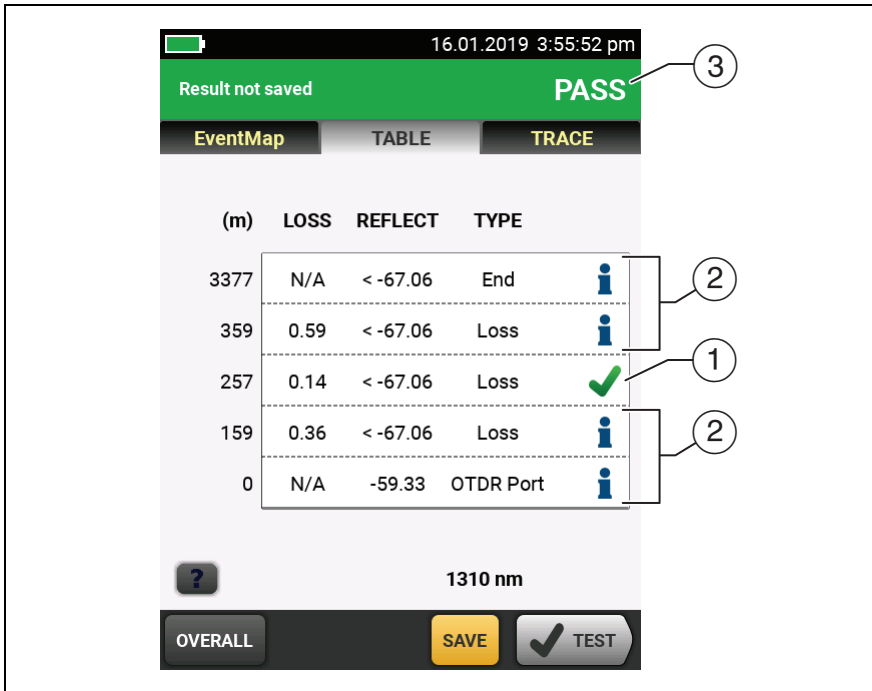

GPU235.EPS

Figure 107. Event Table for a Span

- ① Events in the span have **PASS/FAIL** results.
- ② Events outside of the span do not have **PASS/FAIL** results. The tester shows an for these events.
- ③ **PASS**: All measurements in the span were within the limits.
FAIL: One or more measurements in the span exceeded its limit.

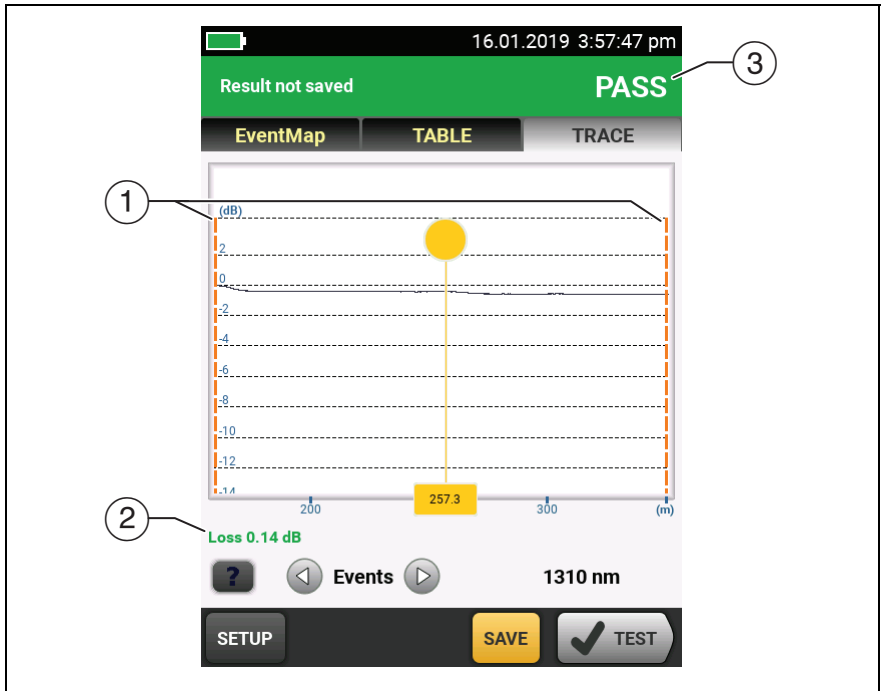

GPU236.EPS

Figure 108. OTDR Trace for a Span

- ① Orange, dashed lines show at the **Span Start** and **Span Stop** locations. The trace is zoomed so that the span section fills the screen.

The launch compensation markers never show with the **Span Start** and **Span Stop** markers because you must turn off launch compensation to use the span function.

- ② Measurements for events in the span show in green if the event passed, red if the event failed, or black if there is no limit for measurement.

Measurements for events outside of the span show in blue.

Note

*When the **Span Stop** location is in the middle of an event, the tester shows the loss for the entire event.*

- ③ **PASS:** All measurements in the span were within the limits.
- FAIL:** One or more measurements in the span exceeded its limit.

How to Remove the Span Definition

Tap **Tools**, **Span**, then tap **Delete**.

How to Remove the Span Definition from a Test Result

- 1 Import the result into LinkWare PC.
- 2 Double-click on the result, then click **Full Size Trace Viewer**.
- 3 In the **OTDR Trace Viewer** window, click **Span > Clear > OK**, then click **Yes**.

Chapter 10: Use the Visual Fault Locator

Visual Fault Locator Applications

The CertiFiber Pro and OptiFiber Pro modules include a visual fault locator that sends a red light down the fiber. The red light shows at the end of the fiber and at breaks, cracks, and sharp bends along the fiber.

The VFL also helps you quickly verify the continuity of fibers, identify connectors, and find faults along fibers and in connectors.

The VFL helps you do these tasks:

- Quickly verify the continuity of fibers.
- Identify the polarity of duplex connections.
- Identify connections in patch panels.
- See breaks and bad splices. These faults cause the fiber to emit red light.
- See high-loss bends. If you can see the light from the VFL at a bend in a fiber, the bend is too sharp.
- See connectors that have damaged fibers inside. A damaged fiber inside a connector causes a red light in the connector.
- Increase the quality of mechanical splices and pre-polished connectors: Before you seal the splice or connector, adjust the fiber alignment for the minimum amount of light where the fibers touch. (Refer to the instructions from the manufacturer when you make splices and connectors.)

How to Use the VFL

Figure 109 shows the equipment for tests with the visual fault locator.

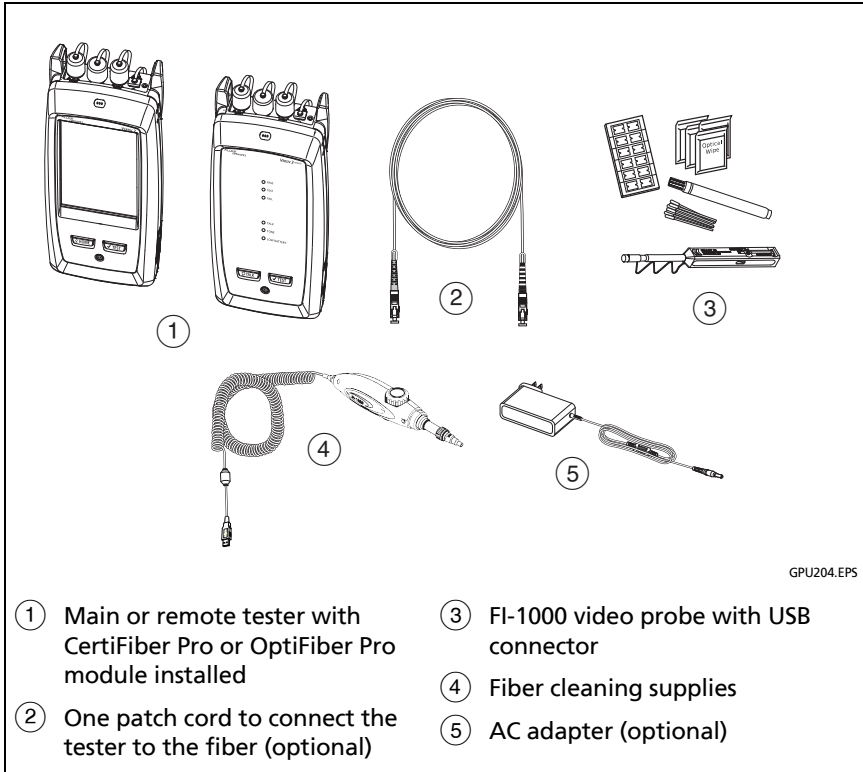

Figure 109. Equipment for Visual Fault Locator Tests

To use the visual fault locator

Note

You can connect the visual fault locator to connectors that have 2.5 mm ferrules (SC, ST, or FC). To connect to other ferrule sizes, use a test reference cord with the correct connector at one end and a SC, ST, or FC connector at the tester end.

- 1 Clean and inspect the connectors on the patch cord, if used, and the fiber to be tested.
- 2 Connect the fiber directly to the VFL port or use the patch cord to connect to the port.
- 3 Use the VFL button to turn on the visual fault locator (refer to Figure 110).

Or, on the home screen tap **TOOLS**, then tap **Visual Fault Locator (VFL)**.

On the main tester you can tap the **PULSE/OFF/CW** (continuous wave) button on the screen to change the modes of the VFL, or use the button as shown in Figure 110.

- 4 Look for the red light as shown in Figure 110.
- 5 To see the light that comes out of a connector, hold a white paper in front of the fiber connector.

Notes

The fiber connector at the VFL and the fiber near the connector can emit red light when there are no faults there because the light is strong at the VFL output.

The light from the VFL is possibly not visible through dark-colored fiber jackets.

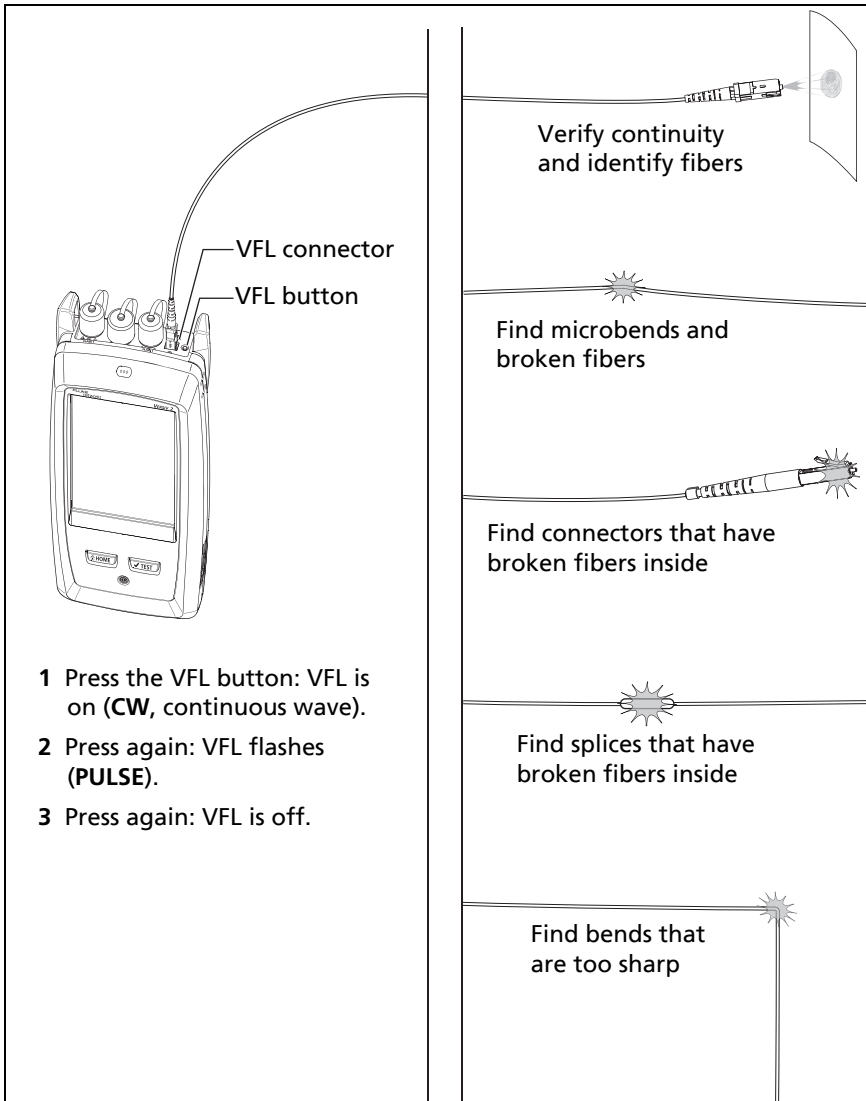

Figure 110. How to Use the Visual Fault Locator

Chapter 11: Monitor Optical Power

You can use the CertiFiber Pro main tester to monitor and save measurements of optical power and loss, and you can use the main or remote tester and as an optical power source. You can use the main tester's power or loss meter and its light source at the same time. How to Monitor Power and Loss

The power meter lets you monitor the optical power supplied by a source such as an optical network interface card or optical test equipment. You can do these tasks:

- Monitor minimum and maximum power levels in **dBm** (decibels per milliwatt), **mW** (milliwatts), **μW** (microwatts), or **nW** (nanowatts).
- Monitor power loss compared to a reference level.
- **Auto CertiFiber Pro** and **Auto SimpliFiber Pro** modes let you monitor power and loss at two wavelengths when you use a CertiFiber™ Pro or SimpliFiber® Pro source.
- Save power and loss measurements for two wavelengths in one record.

Figure 111 shows the equipment for power meter measurements.

Notes

*It is not necessary to select a **Fiber Type** or **Test Limit** when you monitor power or loss. These tests do not have **PASS/FAIL** results.*

Power and loss measurements from sources that transmit network data can change as the data rate changes.

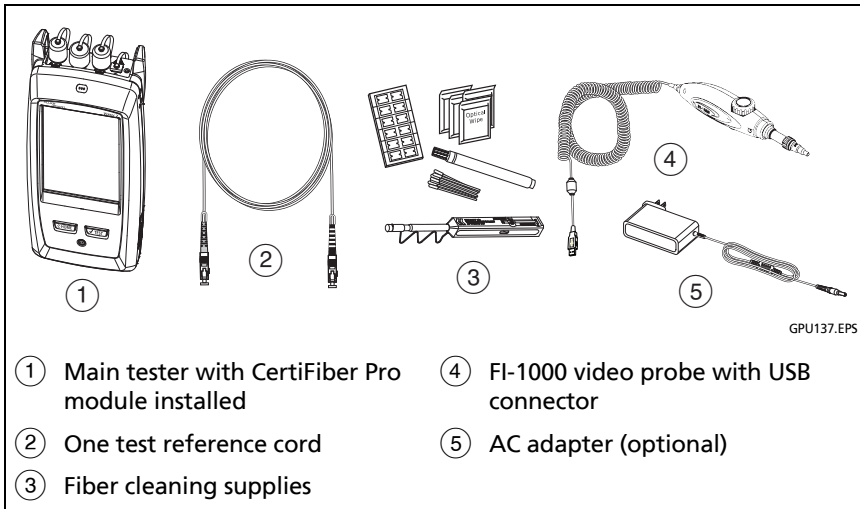
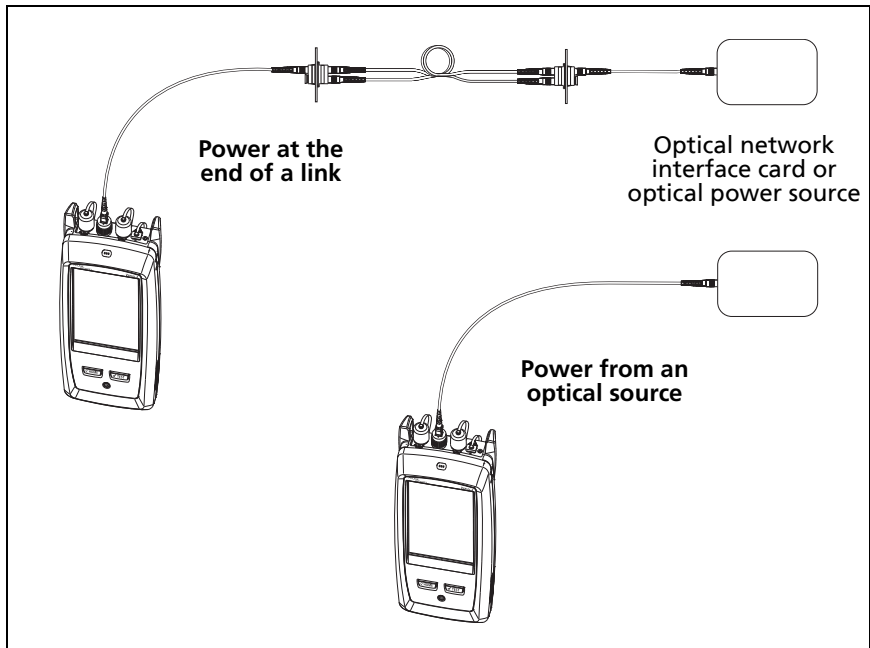

Figure 111. Equipment for Power Meter Measurements

To monitor power

- 1 Clean and inspect the tester's input port and the connectors on the source and test reference cord.
- 2 Connect the tester to the source, as shown in Figure 112.
- 3 Turn on the source. On a CertiFiber Pro module, hold down the button adjacent to the VFL port for 3 seconds.
- 4 On the home screen, tap **TOOLS**, then tap **Power Meter / Light Source**.
- 5 The default mode for the power meter is **Auto CertiFiber Pro**. If the source is not a CertiFiber Pro tester, tap λ to select the correct mode.

Figure 113 shows the power meter and its controls.



GPU138.EPS

Figure 112. Connections to Monitor Power and Loss

To monitor loss

On the **POWER METER / LIGHT SOURCE** screen, tap **REF** to use the present power level as a reference. The meters show the difference between the reference power levels and the measured power levels.

To save the power and loss measurements

- 1 On the **POWER METER / LIGHT SOURCE** screen, tap **SAVE**.
- 2 On the **SAVE RESULT** screen, select **End 1** or **End 2**, make sure the **Cable ID** and **End** name are correct, then tap **SAVE**. Saved power meter results show these icons for **End 1** and **End 2**: **PM2** **PM1**

The tester saves the present, minimum, maximum, and reference power and loss measurements for both wavelengths in one record.

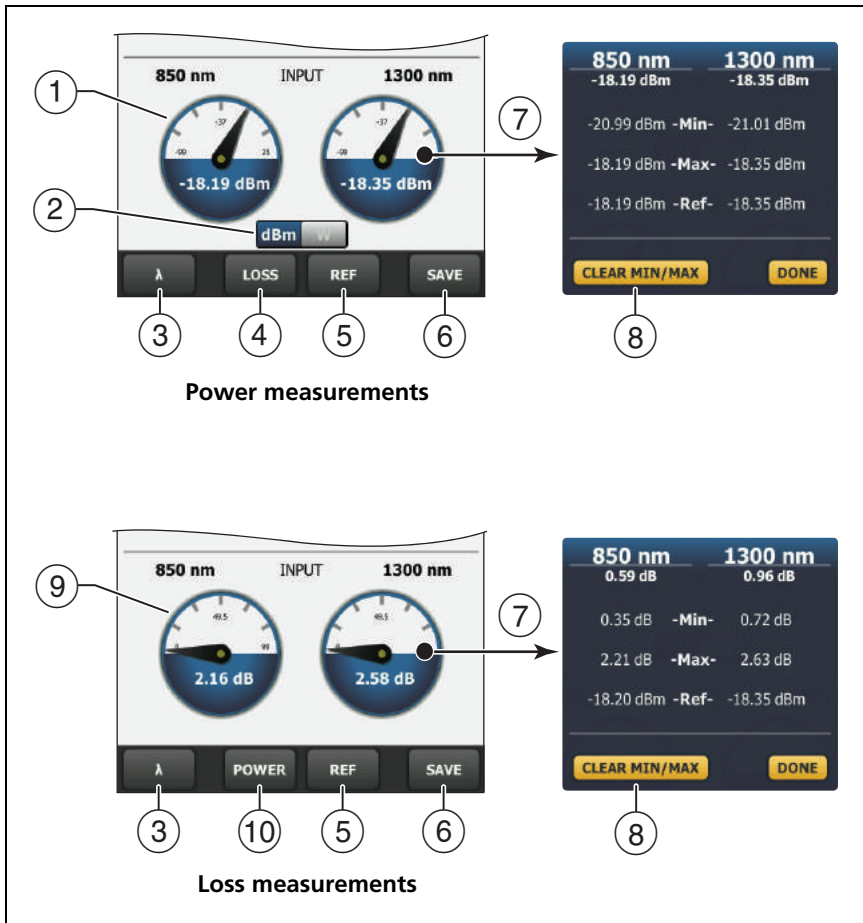

GPU126.EPS

Figure 113. Power Meter Measurements and Controls

- ① The meters show the power levels received on the input port.
- ② This control shows when the meters measure absolute power. Tap the control to see the power measurement in **dBm** (decibels per milliwatt), **mW** (milliwatts), **μW** (microwatts), or **nW** (nanowatts).

- ③ To select a wavelength for the power meter, tap λ .
Use the **Auto CertiFiber Pro** and **Auto SimpliFiber Pro** modes only with a CertiFiber Pro or SimpliFiber Pro source. In these modes, the tester reads the wavelength identifiers transmitted by the source to know when to measure power at each wavelength.
- ④ To monitor power loss (⑨), tap **LOSS** or **REF**.
- ⑤ When you tap **REF**, the tester saves the present measurements as reference levels and the meters show power loss (⑨).
- ⑥ To save the power and loss measurements, tap **SAVE**.
- ⑦ To see the present, minimum, maximum, and reference power or loss levels, tap a meter.
- ⑧ To set the minimum and maximum values to zero, tap **CLEAR MIN/MAX** in the **Min/Max/Ref** window.
- ⑨ When you tap **LOSS** or **REF**, the meters show power loss. The loss is the difference between the reference power levels and the measured power levels.
- ⑩ To monitor absolute power, tap **POWER**.

How to Control the Light Source

When you do tests in Far End Source mode, you use the button on the module to turn on the remote's light source manually. You can also turn on the main tester's light source manually and use the main tester as an optical source.

Use the Display to Control the Main Tester's Light Source

- 1 Clean and inspect all connectors you will use.
- 2 Connect the tester's output port to the power meter.
If your tester has a CertiFiber Pro Quad module installed, make sure you connect the fiber to the correct output port.
- 3 On the home screen tap **TOOLS**, tap **Power Meter / Light Source**, then select settings for the source. See Figure 114.

Use the Module's Button to Control the Light Source

The button next to the VFL port puts the output port in auto wavelength mode. In this mode, the port transmits both wavelengths (850 nm and 1300 nm or 1310 nm and 1550 nm). The signal includes identifiers that tell the meter when to measure power at each wavelength. Use this mode only with a CertiFiber Pro or SimpliFiber Pro power meter.

Note

The remote source always operates in auto wavelength mode.

- 1 Clean and inspect all connectors you will use.
- 2 Connect the tester's output port to the power meter.
If your tester has a CertiFiber Pro Quad module installed, make sure you connect the fiber to the correct output port.
- 3 Hold down the button adjacent to the VFL port for 3 seconds.
On CertiFiber Pro Quad modules, to turn on the singlemode source, press the button again.
On a main tester used as a source, you can use the **POWER METER / LIGHT SOURCE** screen to select different settings for the source. See Figure 114.

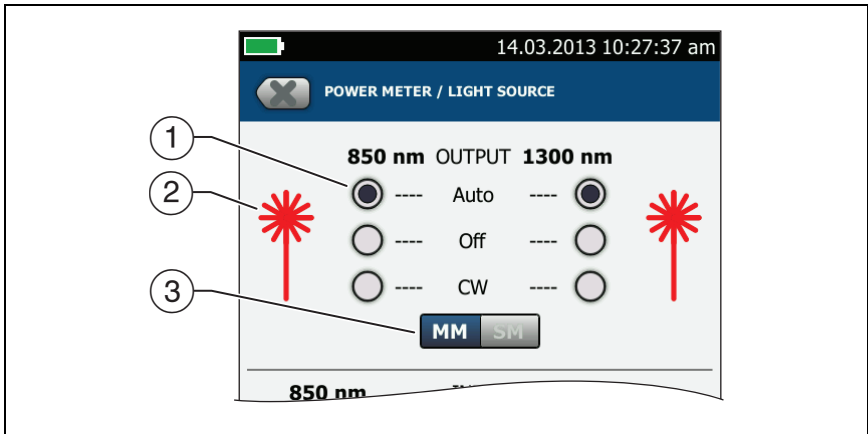

GPU127.EPS

Figure 114. Light Source Controls for the Main Tester

- ① Use the buttons to control the output port when you use the main tester as a light source:
 - **Auto:** In this mode, the output port transmits both wavelengths. The signal includes identifiers that tell a CertiFiber Pro or SimpliFiber Pro power meter when to measure power at each wavelength. Use this mode only with a CertiFiber Pro or SimpliFiber Pro power meter.
 - **Off:** The output port does not transmit the selected wavelength.
 - **CW:** The output port transmits a continuous signal at one wavelength. Use this mode if the power meter is not a CertiFiber Pro or SimpliFiber Pro meter.
- ② The laser icon is red when the output port transmits the wavelength adjacent to the icon.
- ③ When the tester has a CertiFiber Pro Quad module installed, use this control to select multimode or singlemode wavelengths

Chapter 12: Manage Test Results

View Saved Results

On the home screen, tap the **RESULTS** icon. The **RESULTS** screen shows the results in the active project. See Figure 115.

To view results saved on a USB flash drive, connect the drive, then tap **RESULTS, TRANSFER, USB Flash Drive, Import**. See “Manage Results on a Flash Drive” on page 288.

To organize results and make reports you can give to customers, use LinkWare PC software.

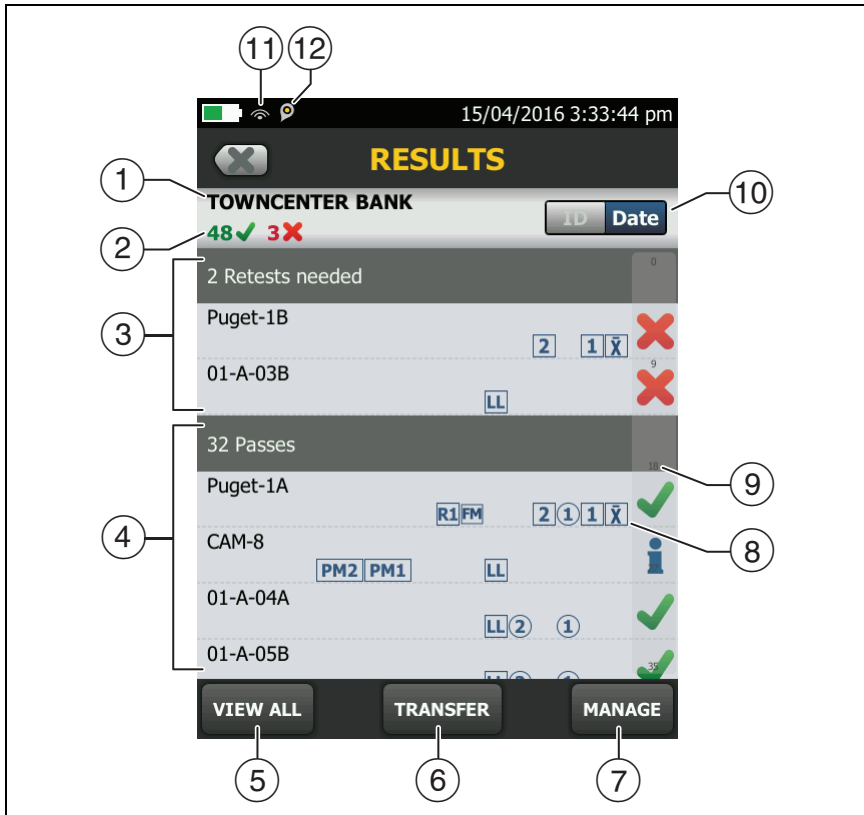

HEJ24.EPS



Figure 115. RESULTS Screen

- ① The name of the active project.
- ② ✓ : The number of results that passed. This includes individual results for each ID and tests that have an  result.
- ✗ : The number of results that failed. This includes individual results for each ID.

: The number of DSX CableAnalyzer results that have **PASS*** results. **PASS*** results have measurements within the range of accuracy uncertainty for the tester. See “PASS*/FAIL* Results” on page 53.

Note

IDs can contain multiple results. So, these numbers can be more than the number of IDs saved.

- ③ The cable IDs that have **FAIL** results and must be tested again. Because some IDs can have one or more tests that failed, the number at the top of this screen (②) can be more than the number of retests needed.
- ④ The cable IDs that have an overall **PASS** or  result. Because some IDs can have one or more tests that passed or have an  status, the number at the top of this screen (②) can be more than the number of passes.

IDs that start with “TRC” are from verification tests on fiber test reference cords. These IDs show the date and time of the test.

- ⑤ Tap **VIEW ALL** to see a summary of the results in all the projects in the tester.
- ⑥ **TRANSFER** lets you export or import results to or from a flash drive and delete results on the flash drive. The **TRANSFER** function also lets you sync project setups and results with LinkWare Live.
- ⑦ **MANAGE** lets you move results to a different project, rename results, or delete results that are in the tester.
- ⑧ The icons show the types of fiber test results that the result contains:

No icon: DSX CableAnalyzer results from copper cabling.

 Loss/length results from a CertiFiber Pro OLTS module.

 OptiFiber Pro OTDR results from End 2 and End 1. The result can be from an **Auto**, **Manual**, **SmartLoop**, or **DataCenter OTDR** test.

 Averaged results from a bi-directional OTDR test.

 Power meter results from End 2 and End 1 from a CertiFiber Pro OLTS module.

 FiberInspector results from End 2 and End 1.

 FaultMap results from an OptiFiber Pro OTDR module.

 Real Time Trace results from End 2 and End 1 from an OptiFiber Pro OTDR module.

- ⑨ The scroll bar shows when the list of results is long. To use the scroll bar, tap on the bar or slide your fingertip on the bar. For example, to see the 12th result in the list, tap on “12” in the scroll bar. When you slide your fingertip on the bar, the number of the result you can see is next to your fingertip.
- ⑩ Tap the **ID/Date** control to sort the results by cable ID or by date. When you sort by ID, the results show in ascending order. When you sort by date, the latest result is at the top of the list.
- ⑪ These icons show when you connect the tester to a network to use Fluke Networks cloud services (see Chapter 14):

 The tester is connected to a wireless network.

 The tester is connected to a wired network.

- ⑫  The asset management icon shows when the owner of a LinkWare Live account has enabled the asset management service on the tester. “About the Asset Management Service” on page 309.

How to Add a Result to a Saved Result

You can save the results from different tests in one cable ID. For example, you can save CertiFiber Pro results and FiberInspector results together in one ID.

When you add results, these settings used to get the results must agree with the settings in the saved result:

- Test limit
- Fiber categories (singlemode/multimode, core size, category)
- Index of refraction (makes a warning you can override)

If the settings do not agree, the tester shows a warning.

To add results for a different End setting

- 1 Do the test, then tap **SAVE**.
- 2 On the **SAVE RESULT** screen, select **End 1** or **End 2**, make sure the **Cable ID** and **End** name are correct, then tap **SAVE**.

To add results from a different test

- 1 On the home screen, tap the test setup panel.
- 2 On the **CHANGE TEST** screen, tap the button next to a test, then tap **USE SELECTED**.
 - If the ID set has a **Last ID**, the home screen shows the first ID in the set that does not have results for the test you selected.
 - If the ID set does not have a **Last ID**, tap the **Next ID** panel, tap the **Next ID** box on the **CHANGE ID** screen, enter the first ID for the set of saved results, then on the **CHANGE ID** screen, tap **DONE**.
- 3 Tap **TEST** or press **TEST**, then save the result.

How to Replace a Saved Result that Failed

To use the same test settings that were used for the saved result

- 1 On the home screen, tap the **RESULTS** icon.
- 2 On the **RESULTS** screen, tap a result that failed.
- 3 Tap **TEST AGAIN**.
- 4 When the test is completed, and if **Auto Save** is on, the tester asks you if you want to overwrite the results. Tap **Yes**.

If **Auto Save** is off, tap **FIX LATER** (if the test failed) or **SAVE** (if the test passed) to save the result.

To replace a result with a result that uses different test settings

- 1 Turn off **Auto Save**.
- 2 Make sure that the home screen shows the project that contains the result you want to replace.
- 3 Select the necessary test settings.
- 4 Do the test, tap **FIX LATER** (if the test failed) or **SAVE** (if the test passed), then enter the ID of the saved result.
- 5 The tester asks you if you want to overwrite the results. Tap **Yes**.

Delete, Rename, and Move Results

Before you delete, rename, or move results, select the project that contains the results and go to the **MANAGE RESULTS** screen:

- 1 On the home screen, tap the **RESULTS** icon. The **RESULTS** screen shows the results in the active project.
- 2 To see the results in another project, tap **VIEW ALL**, then tap a project.
- 3 Tap **MANAGE** to see the **MANAGE RESULTS** screen.

To delete results

- 1 On the **MANAGE RESULTS** screen, select the results you want to delete.
To select all the tests that failed or all the tests that passed, tap **Select All Retests** or **Select All Passes**.
- 2 Tap **DELETE**, then tap **DELETE** in the confirmation dialog.

To rename results

- 1 On the **MANAGE RESULTS** screen, select one result to rename.
- 2 Tap **RENAME**.
- 3 Enter a new name, then tap **DONE**.

To move results to a different project

- 1 On the **MANAGE RESULTS** screen, select the results you want to move.
- 2 Tap **MOVE**.
 - To move the results to a project shown in the list, tap the project name, then tap **MOVE** in the confirmation dialog.
 - To make a new project and move the results to the new project, tap **NEW PROJECT**, enter a project name, tap **DONE**, then tap **MOVE** in the confirmation dialog.

Note

When you move results to a different project, that project becomes the active project.

Manage Results on a Flash Drive

You can export or import results to or from a flash drive, and delete results on the flash drive.

To export or import project settings along with results, see “Manage Projects on a Flash Drive” on page 300.

Caution

- **Do not remove the USB flash drive while the LED on the drive flashes. Doing so can corrupt the data on the drive.**
- **You can lose a USB flash drive, cause damage to it, or accidentally erase the contents of the drive. Thus, Fluke Networks recommends that you save no more than one day of test results on a flash drive.**

Note

The tester reads only USB drives that use the FAT format.

- 1 Connect a USB flash drive to the type A USB port. The tester makes a bell sound when it detects the drive.
- 2 On the home screen, tap the **RESULTS** icon, then tap **TRANSFER**.
- 3 On the **TRANSFER RESULTS** screen, tap **USB Flash Drive**, then tap a function:
 - **Export:** On the **EXPORT RESULTS** screen, select **New** or **All**, select the project that contains the results you want to export to the flash drive, then tap **EXPORT**.
New: Export only results that do not have the same IDs as results that are already on the flash drive.
All: Export all the results from all projects in the tester.

Note

Cable IDs are case-sensitive. For example, the tester saves result with the names "A0" and "a0" in two different records.

- **Import:** On the **IMPORT RESULTS** screen select the project that contains the results you want to import from the flash drive, then tap **IMPORT**.
- **Delete:** On the **DELETE RESULTS** screen select the project that contains the results you want to delete on the flash drive, then tap **DELETE**.

Upload Results to a PC

Note

To upload results to the cloud for transfer to a PC, use the LinkWare Live web application. See Chapter 14.

To upload results to a PC from the tester or a flash drive, use LinkWare PC software.

- 1 Install the latest version of LinkWare PC software on the PC.
- 2 Turn on the tester and start LinkWare PC on the PC.
- 3 Use the USB cable supplied to connect the Micro USB port on the tester to a type A USB port on the PC. See Figure 116.
Or connect a USB flash drive to the PC.
- 4 On the LinkWare PC toolbar, click , then select a product, or select **Test Files (.tst)** to upload from a flash drive.
- 5 In the **Import** dialog box in LinkWare PC, select options for the location and the number of results to import.

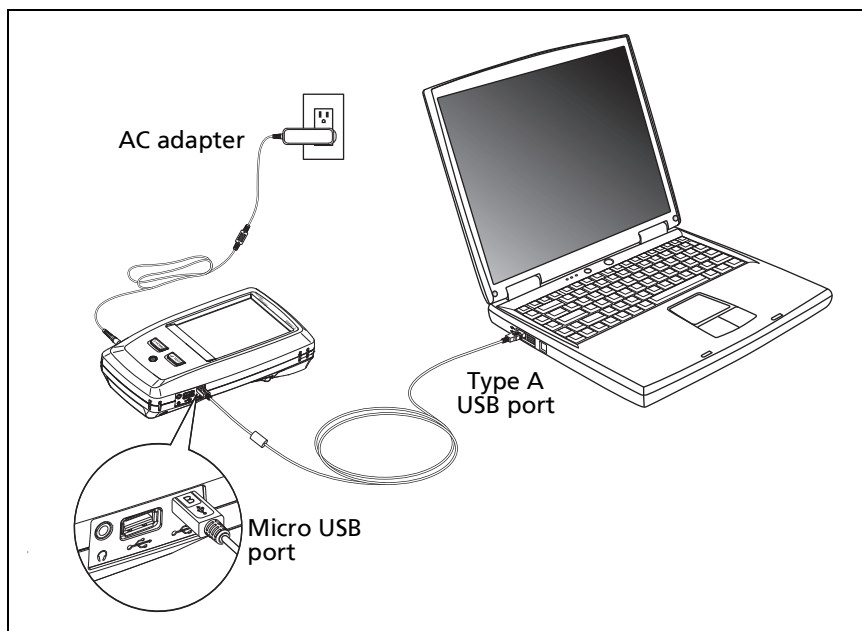

GPU46.EPS

Figure 116. How to Connect the Tester to a PC

Memory Capacity

These are the approximate numbers of tests you can save in a main tester:

DSX CableAnalyzer, Cat 6A Autotest results, with plot data included

- Versiv: 12,000
- Versiv 2: 25,000

CertiFiber Pro Autotest results

- Versiv: 30,000
- Versiv 2: 30,000

OptiFiber Pro OTDR Autotest results, 10 km multimode fiber

- Versiv: 4,500
- Versiv 2: 9,800

The number of test results you can save decreases if you save more tests in each record, or if you save tests that use more memory. For example, records that include OTDR tests and images from the video probe use more memory than records that include OTDR tests and FaultMap tests.

The capacity available for test results depends on the space used by the software and custom test limits in the tester.

To make more memory available, you can export results to a USB flash drive, then delete the results in the tester. See “Manage Results on a Flash Drive” on page 288.

View the Memory Status

To see the memory status

On the home screen, tap the **TOOLS** icon, then tap **Memory Status**.

The **MEMORY STATUS** screen shows these values:

- The percentage of memory available
- The number of test records that are saved
- The number of .id files that have been downloaded to the tester from LinkWare PC software
- The memory space taken by other files, such as the databases for projects and test limits

Chapter 13: Use Projects

Why Use Projects?

The tester's ProjX™ management system lets you set up projects that help you monitor the status of a job and make sure that your work agrees with the requirements of the job.

You can use a project to do these tasks:

- Specify the tests that are necessary for a job.
- Specify settings for tests.
- Specify an operator for the job.
- Make sets of sequential IDs to use as names for test results.
- Automatically save test results with IDs from a set.
- Add the results from other necessary tests to each saved result in the project.
- See which IDs do not have results for a specified test.
- See what percentage of a job is completed.
- See how many links passed and how many failed.
- Keep the test results from a job in one place for easy access.

When you use a project, you can do tests and use IDs that are not specified in the project if necessary. You can also easily change the settings in a project if necessary.

Notes

It is not necessary to install a module to set up a project for the module. The main unit keeps all the settings.

To manage projects in the cloud, use the LinkWare Live web application. See Chapter 14.

Set Up a Project

Refer to the **PROJECT** screen in Figure 117 on page 295.

- 1 On the home screen, tap the **PROJECT** panel, tap **CHANGE PROJECT**, then tap **NEW PROJECT**.
- 2 On the **NEW PROJECT** screen, enter a name for the project, then tap **DONE**.
- 3 On the **PROJECT** screen, tap the **Operator** panel to enter an operator name for the project.
- 4 On the **PROJECT** screen, tap the **NEW TEST** button to enter the tests and test settings necessary for the project.
- 5 On the **PROJECT** screen, tap the **NEW ID SET** button to make one or more sets of cable IDs for the project. See the **CABLE ID SETUP** screen in Figure 118 on page 298.
- 6 On the **PROJECT** screen, tap **DONE**.

The PROJECT Screen

To start a new project, tap the **PROJECT** panel on the screen. Figure 117 shows the **PROJECT** screen and describes the items you enter to make a project.

- ① The name of the project. See also item ⑨.
Projects you download from LinkWare Live include the organization name. They can also include subproject names. On the tester's **PROJECT** screen, these names show in this format: **Organization Name>>Project Name>>Subproject Name**. See "About Project Names from LinkWare Live" on page 297.
- ② **Operator**: The name of the person who will do the tests for the project. For each operator you can also enter the email address that the operator will use as an ID to sign in to LinkWare Live.
- ③ The date range for the results in the project.
- ④ **Results**: A summary of the test results in the project:



GPU08.EPS

Figure 117. PROJECT Screen



✖: The number of tests that failed.

✔: The number of tests that passed.

★: The number of DSX CableAnalyzer results that have **PASS*** results. **PASS*** results have measurements within the range of accuracy uncertainty for the tester. See “PASS*/FAIL* Results” on page 53.

⑤ **Test Setup:** The tests that are available in the project.

To add a test to the project, tap **NEW TEST**.

- ⑥ **Cable ID Sets:** The sets of IDs the tester can use for the names of test results. Each ID set is for either copper or fiber cable.
To add a set of IDs to the project, tap **NEW ID SET**. See Figure 118.
- ⑦ To use a different project, tap **CHANGE PROJECT**, then tap a project.
To make a new project, tap **CHANGE PROJECT**, then tap **NEW PROJECT**.
- ⑧ **TRANSFER** lets you export or import projects to or from a flash drive and delete projects on the flash drive. The project data includes all project settings and test results. The **TRANSFER** function also lets you sync project setups and results with LinkWare Live.
- ⑨ **MANAGE** lets you rename, copy, or delete a project that is in the tester.
- ⑩ To delete the test setup or ID set, tap . To copy the test setup or ID set so you can edit it to make a new one, tap .

Notes

If you delete an imported ID set from a project, the ID set is still available in the tester. To delete imported ID sets from the tester, use LinkWare PC software.

*A project must have at least one **Test Setup** and one **Cable ID** set. If you delete them all, the tester makes a default **Test Setup** and **Cable ID** set.*

About Project Names from LinkWare Live

Projects you download from LinkWare Live include the organization name. They can also include subproject names. On the tester's **PROJECT** screen, these names show in this format: **Organization Name>>Project Name>>Subproject Name**.

LinkWare Live will not use organization or subproject names you create on the tester. If you use the format "**Organization Name>>Project Name>>Subproject Name**" to enter names on the tester, then sync the project to LinkWare Live, LinkWare Live will use all of the names as the project name.

The CABLE ID SETUP Screen

To see the **CABLE ID SETUP** screen, tap the **PROJECT** panel on the home screen, then tap **NEW ID SET** on the **PROJECT** screen. See Figure 118 on page 298.

Each project can have up to 5000 IDs. If an ID set does not have a **Last ID**, the tester counts the set as one ID. An ID can have a maximum of 60 characters. Symbols, such as the asterisk, and accented characters do not increment.

About Next ID Sets

If you do not enter a **Last ID** when you make an ID set, the tester uses the **First ID** as the **Next ID**. The tester increments the Next ID each time you save a result.

- Numbers increment sequentially:
1, 2, 3, 4, 5, 6, 7, 8, 9, 10, 11, 12, ... 99, 100, 101...
- Letters increment through the English alphabet:
A, B, C, D, ... Z, AA, AB, AC, AD, ... AZ, BA, BB, BC...
- Numbers and letters do not cause each other to increment:
1Y, 1Z, 1AA, 1AB, ... 1ZZ, 1AAA, 1AAB...
- The tester does not increment symbols or accented characters.

When you use a **Next ID** set, the set under **IDs Untested** on the **CHANGE ID** screen shows only the next ID. To save the next test with a different ID, tap the **Next ID:** panel, then enter a different ID.

Each project can have one **Next ID** set. You can use the **Next ID** set for copper or fiber results.

If your project has only a **Next ID** set, the tester cannot calculate the percentage of the project that is completed, so the **% Tested** value does not show on the home screen.

If your project has both a **Next ID** set and sets with first and last IDs, the **% Tested** value includes tests you saved with **Next ID**. For example, if you have one **Next ID** set and one set with 10 IDs, and you save 10 results with next IDs, the **% Tested** shows 50% (10 saved results divided by 20 IDs).

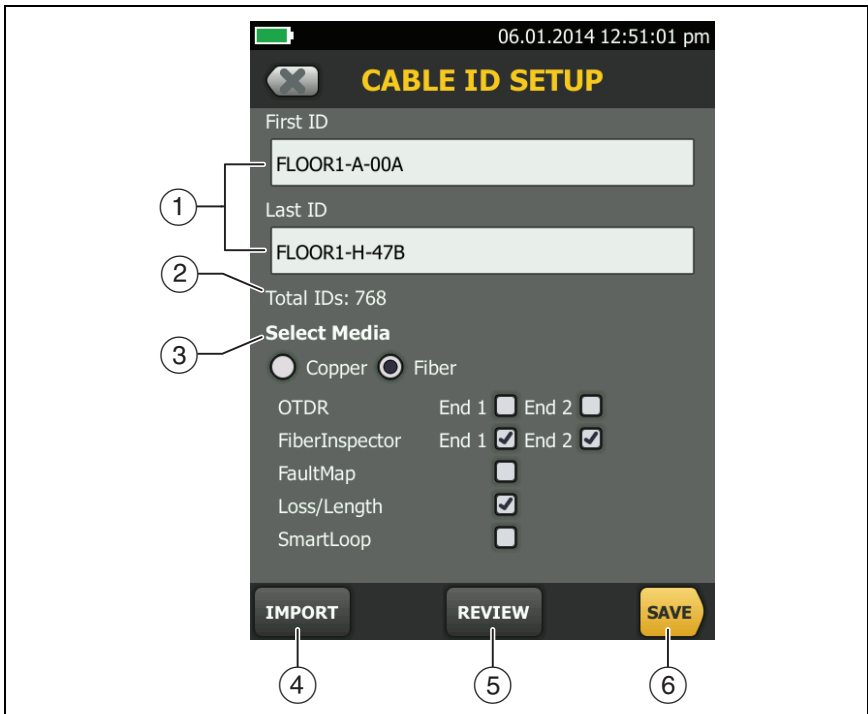

GPU09.EPS

Figure 118. CABLE ID SETUP Screen (after you enter the first and last IDs)

- ① **First ID and Last ID:** The first and last IDs in a set of sequential IDs. If you do not enter a **Last ID** when you make an ID set, the tester will increment the **First ID** to make subsequent IDs.

Note

The tester does not increment symbols or accented characters.

When you use an ID set that does not have a **Last ID**, the set under **IDs Untested** on the **CHANGE ID** screen shows only the next ID.

- ② **Total IDs:** The number of IDs in the set. This section does not show for ID sets that do not have a **Last ID**.
- ③ **Select Media:** Select **Copper** to use the ID set for test results from copper cable.

Select **Fiber** and one or more fiber tests to use the ID set for test results from fiber cable.

For example, you can specify that you must do a **Loss Length** and a **FiberInspector** test for each ID. After you do both tests for all the IDs in the set, the tester shows **100% Tested** on the home screen. If no IDs include FiberInspector results, the tester shows **50%**. To see the IDs that need FiberInspector results, select a **FiberInspector** test in the project, then look at the list under **FiberInspector IDs Untested** on the **CHANGE ID** screen

Notes

*You can use an ID set only for results from the media type you selected under **Select Media**.*

*The **Select Media** section does not show for ID sets that do not have a **Last ID**. You can use these ID sets for copper or fiber results.*

- ④ Tap **IMPORT** to use an ID set that you downloaded to the tester from LinkWare PC software.
- ⑤ Tap **REVIEW** to see the **CABLE ID REVIEW** screen, which shows the ID set and the total number of IDs.

Note

The **REVIEW** button does not show if you do not enter a **Last ID**.

- ⑥ **SAVE:** To save the ID set, tap **SAVE**.

Manage Projects on a Flash Drive

You can export or import projects to or from a flash drive, and delete projects on the flash drive. The project data includes all project settings, test results, and ID sets.

Caution

- Do not remove the USB flash drive while the LED on the drive flashes. Doing so can corrupt the data on the drive.
- You can lose a USB flash drive, cause damage to it, or accidentally erase the contents of the drive. Thus, Fluke Networks recommends that you save no more than one day of test results on a flash drive.

Note

The tester reads only USB drives that use the FAT format.

- 1 Connect a USB flash drive to the type A USB port. The tester makes a bell sound when it detects the drive.
- 2 On the home screen, tap the **PROJECT** panel.
- 3 On the **PROJECT** screen, tap **TRANSFER**.
- 4 On the **TRANSFER PROJECTS** screen, select a function:
 - **Export:** On the **EXPORT PROJECTS** screen, select the projects you want to export to the flash drive, then tap **EXPORT**.
 - **Import:** On the **IMPORT PROJECTS** screen select the projects you want to import from the flash drive, then tap **IMPORT**.

- **Delete:** On the **DELETE PROJECTS** screen select the projects you want to delete on the flash drive, then tap **DELETE**.

Copy Project Settings to Other Testers

To copy the settings in a project to other testers, use the **Read Project Setups** and **Write Project Setups** utilities in LinkWare PC software. You can use LinkWare PC to read project settings from a tester or from a project you exported to a flash drive.

The LinkWare Live Web Application

The LinkWare Live web application lets you manage your projects from a desktop or mobile device.

To get started with LinkWare Live, see Chapter 14.

Chapter 14: Sync Projects with LinkWare™ Live

The LinkWare Live web application lets you manage your projects from a desktop or mobile device.

Note

To make sure you can use the latest features in LinkWare Live, keep your tester updated with the latest Versiv software.

Sign Up for a LinkWare Live Account

- 1 Go to www.linkwarelive.com/signin.
- 2 If you already have a LinkWare Live account, enter your email address and password on the LinkWare Live **Sign In** page.
- 3 If you do not have a LinkWare Live account, click **New user? Sign up now!**. Enter the information for your account, then click **CREATE ACCOUNT**.
Fluke Networks sends you an email with a LinkWare Live activation code.
- 4 Open the email, copy the activation code, click the LinkWare Live activation link in the email, paste the activation code into the box in the activation window, then click **ACTIVATE**.
- 5 The LinkWare Live **Sign In** page shows again. Enter your email address and password, then click **SIGN IN**.

How to See the Tester's MAC Address

Some networks require users to register their device's MAC address before they can connect to the network.

There are two MAC addresses: one for the wired port and one for Wi-Fi.

Versiv 2 testers have an internal Wi-Fi radio. Versiv testers use an external adapter to connect to Wi-Fi networks.

To see the tester's MAC address

- 1 For a Versiv that uses an external Wi-Fi adapter, connect the adapter to the tester's USB port.
- 2 On the home screen tap **TOOLS**, then tap **Network**.
- 3 On the **NETWORK** screen, tap the **Wired** or **Wi-Fi panel**. The MAC addresses shows at the top of the **WIRED** and **WI-FI PORT** screens.

Use LinkWare Live Through a Wired Ethernet Network

- 1 Use an appropriate cable to connect the tester's RJ45 Ethernet port to an active network port. If the cable is good and the port is active, the LEDs on the tester's port will come on.
- 2 On the home screen, make sure the **Operator** name is correct. The tester uses the email address associated with the operator name as the ID when you sign in to LinkWare Live.

If no address is associated with the name, or if you enter a different address on the **LWL SIGN IN** screen, the tester associates the name with the address you enter.

- 3 On the home screen, tap the **SYNC** icon.
- 4 When the tester connects to the network, the wired network connection icon shows at the top of the screen: 

- 5 On the **LWL SIGN IN** screen, if necessary, enter the ID and password for your LinkWare Live account, then tap **SIGN IN**.
- 6 If you use other people's LinkWare Live accounts, the **ORGANIZATION** screen shows. Tap the organization you want to use.
- 7 On the **SYNC PROJECTS** screen (Figure 119 on page 307), select the projects you want to sync, then tap **SYNC**.

Use LinkWare Live Through a Wi-Fi Network

Note

The testers in some custom kits do not support Wi-Fi (for example, in some kits purchased for government applications). These testers do not show any Wi-Fi settings.

Versiv 2 testers have an internal Wi-Fi radio. These testers do not need an external adapter to connect to Wi-Fi networks.

To connect a Versiv tester to a Wi-Fi network, you must have an optional USB Wi-Fi adapter. Fluke Networks recommends these adapters:

- TP-LINK TL-WN725N, Versions 1 and 2 (recommended)
- NETGEAR WNA1000M

Other adapters may be suitable. For the latest list of qualified adapters, see this topic in the Fluke Networks Knowledge Base:

www.bit.ly/1ACJeFO

To use a Wi-Fi network

- 1 For a Versiv that uses an external Wi-Fi adapter, connect the Wi-Fi adapter to the tester's type A USB port.
- 2 On the home screen, make sure the **Operator** name is correct. The tester uses the email address associated with the operator name as the ID when you sign in to LinkWare Live.

-continued-

If no address is associated with the name, or if you enter a different address on the **LWL SIGN IN** screen, the tester associates the name with the address you enter.

- 3 On the home screen, tap the **SYNC** icon.
- 4 Select a wireless network if necessary.
 - **If a notice about additional information shows**

Tap **OK**, then enter the required credentials on the **REDIRECTED LOGIN** screen and log in. If another **REDIRECTED LOGIN** screen shows after you log in, tap **DONE** on that screen.
 - **If the NETWORK screen shows**

The network settings are not correct. To change the settings:

 - a. Tap the **Wi-Fi** panel, then change the settings as necessary. Table 10 on page 311 describes the Wi-Fi settings.
 - b. To test the settings, go back to the **WI-FI PORT** screen, then tap **CONNECT**.

When the tester connects to the network, the Wi-Fi network connection icon shows at the top of the screen: 
- 5 On the **LWL SIGN IN** screen enter the ID and password for your LinkWare Live account, then tap **SIGN IN**.
- 6 If you use other people's LinkWare Live accounts, the **ORGANIZATION** screen shows. Tap the organization you want to use.
- 7 On the **SYNC PROJECTS** screen (Figure 119), select the projects you want to sync, then tap **SYNC**.

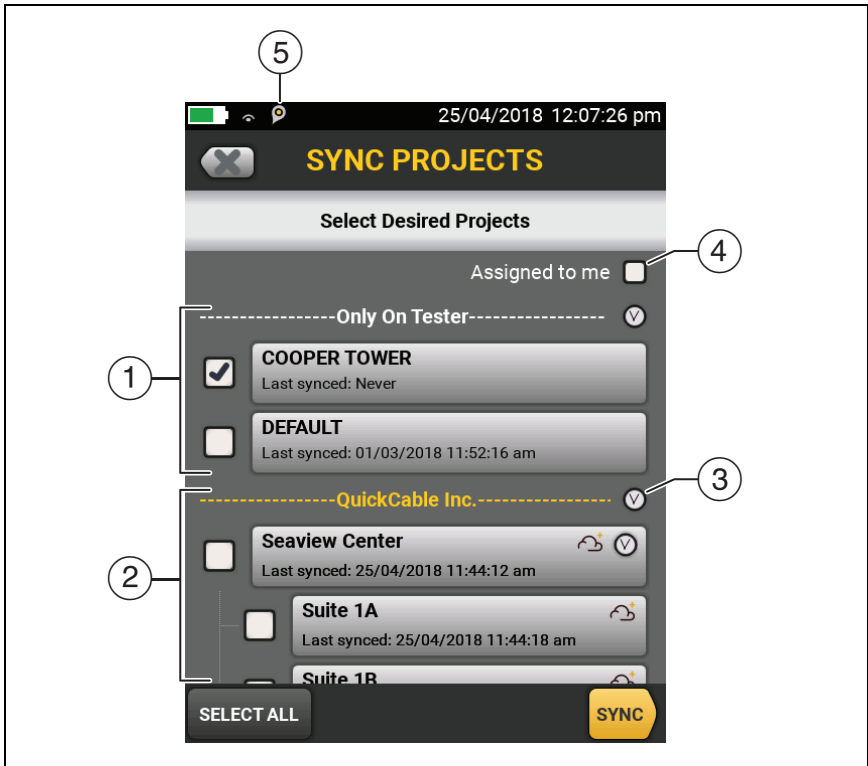

GPU190.EPS

Figure 119. SYNC PROJECTS Screen

- ① These projects are only on the tester. They have not been synced to LinkWare Live.

By default, the active project is selected to sync.

- ② These projects and subprojects are in the LinkWare Live organization shown ("QuickCable" in this example).



To update the list without syncing projects, tap , then tap the LinkWare Live panel again.

 The cloud icon shows that the project is only in LinkWare Live and has not been synced to the tester.

 The cloud and “+” icon shows that the project in LinkWare Live has been synced to the tester, so you can use the project on the tester.

Note

*If you rename a synced project on the tester or in LinkWare Live, and the project has the **Active** status in LinkWare Live, the **SYNC PROJECTS** screen on the tester shows both names in the format **Versiv Project Name -> LinkWare Live Project Name**. After you sync, the project’s name on the tester changes to the name used in LinkWare Live.*

- ③ Tap  to collapse or expand the list of projects or subprojects.
- ④ If you select **Assigned to me**, you will see only projects that are assigned to you in the project settings in LinkWare Live.
- ⑤  The asset management icon shows when the owner of a LinkWare Live account has enabled the asset management service for the tester. See “About the Asset Management Service”.

When You Cannot Sync a Deleted Project

When you delete a project in LinkWare Live, it goes into the recycle bin. If you synced the project before it was deleted, then try to sync it again, the tester shows a message to tell you that you cannot sync a deleted project. You will see this message even if you rename the project on the tester because LinkWare Live gives each project a unique, hidden ID that never changes, and uses this ID to identify projects. If it is necessary to sync the project, go to the LinkWare Live recycle bin and restore the project.

If a project in the LinkWare Live recycle bin has never been synced, and you create a project with the same name on Versiv

then sync the project, LinkWare Live shows it as a new, active project and gives it a unique ID.

About the Asset Management Service

LinkWare Live's asset management service lets you see the locations of your Versiv and Versiv 2 testers in the field. The owner of the LinkWare Live account can enable or disable the service remotely for each tester.

When this service is enabled on a tester, the asset management icon () shows on the tester's home screen. When a technician uses the tester to sign in to LinkWare Live, the tester's location shows on a map on LinkWare Live's **ASSETS** page.

Note

You can enable or disable the asset management service only with LinkWare Live. There is no setting on the tester that enables or disables this service.

Change the Network Settings

It is not usually necessary to change the wired or Wi-Fi network settings before you try to make a connection. But for example if you must use static addressing, you can get to the settings on the **NETWORK** screen.

To get to the network settings

On the home screen, tap **TOOLS**, then tap **Network**, then tap the **Wired** or **Wi-Fi** panel.

To test the settings

Tap **CONNECT** on the **WI-FI PORT** or **WIRED PORT** screen.

Settings for the Wired Port

The tester can use **DHCP** (dynamic host configuration protocol) or **Static** for the address method. Most networks use **DHCP**.

For **Static**, enter an IP address for the tester and the **Subnet Mask**, **Gateway** address, and **DNS1** and **DNS2** addresses for the network. If you are not sure what to enter, speak to the network administrator.

Settings for Wi-Fi

Table 10 shows the Wi-Fi settings.

Regulatory Information for the Wi-Fi Radio

To see the regulatory information

On the home screen, tap **TOOLS**, then tap **Regulatory Information**.

Delete Wi-Fi Settings and Passwords

The tester saves the security settings and passwords for the Wi-Fi connections you use.

To delete all Wi-Fi settings and passwords

On the home screen, tap **TOOLS**, then tap **Network**, tap the **Wi-Fi** panel, then tap **FORGET ALL**.

Sign Your Tester Out of LinkWare Live

- 1 On the home screen, tap the **TOOLS** icon, then tap **Sign In**.
- 2 On the **LWL SIGN IN** screen, tap **SIGN OUT**.

Or, turn off the tester.

Table 10. Settings for the Wi-Fi Connection

Setting	Description
Address	Most networks use DHCP.
DHCP address settings	<p>SSID: The tester does a scan for wireless networks and shows a list of available networks. Select the correct SSID.</p> <p>To connect to a hidden network, tap ADD SSID.</p> <p>Security:</p> <ul style="list-style-type: none"> • Authentication: Select the authentication type that the network uses: <ul style="list-style-type: none"> ♦ Open: Security credentials are not necessary. ♦ WEP: Select an encryption method and enter the necessary keys. ♦ WPA/WPA2 Personal: Enter the password for the network. • WPA/WPA2 Enterprise: <ul style="list-style-type: none"> ♦ EAP: Select an EAP type that is appropriate for the authentication server. ♦ User and Password: Enter a user name (login name) and password for the network. ♦ Alternate ID: The tester can use the Alternate ID with some EAP methods to send an empty or anonymous identity while the tester makes a private connection. The tester then uses the private connection to send the User name and Password you entered. <p>The tester can also use the Alternate ID to send the User name and Password to an authentication server in a different realm. In this situation, the Alternate ID can have a format such as anonymous@MyCompany.com or / MyCompany/anonymous.</p>
Static address settings	<p>Enter an IP address for the tester and the Subnet Mask, Gateway address, and DNS1 and DNS2 addresses for the network. If you are not sure what to enter, speak to the network administrator.</p> <p>The Security settings are the same as for the DHCP address settings.</p>

Sign In to LinkWare Live from a Desktop or Mobile Device

- 1 Go to <https://www.linkwarelive.com/signin>.
- 2 Enter your LinkWare Live user name and password, then click **SIGN IN**.

For more information about how to use LinkWare Live, click **HELP** on the LinkWare Live web page.

Import Projects from LinkWare Live into LinkWare PC

- 1 Install the latest version of LinkWare PC software on the PC.
- 2 Turn on the tester and start LinkWare PC on the PC.
- 3 Use the USB cable supplied to connect the Micro USB port on the tester to a type A USB port on the PC.
- 4 On the LinkWare PC toolbar, click . The icon is a red square with a white 'Lw' inside.
- 5 Sign in to your LinkWare Live account, then use the LinkWare PC dialog boxes to select and import projects.

Learn More About LinkWare Live

Go to <http://www.flukenetworks.com/linkwarelive>.

Chapter 15: Maintenance

Warning

To prevent possible fire, electric shock, personal injury, or damage to the tester:

- Do not open the case. You cannot repair or replace parts in the case.
- Use only replacement parts that are approved by Fluke Networks.
- If you replace parts that are not specified as replacement parts, the warranty will not apply to the product and you can make the product dangerous to use.
- Use only service centers that are approved by Fluke Networks.

Caution

If you replace electrical parts yourself, the tester will possibly not have the correct calibration and can give incorrect test results. If the calibration is not correct, cable manufacturers can remove their warranty from the cabling you install.

Verify Operation

The tester does a self test when you turn it on. If the tester shows an error or does not turn on, refer to “If the Tester Does Not Operate as Usual” on page 322.

Clean the Tester

To clean the touchscreen, turn off the tester, then use a soft, lint-free cloth that is moist with water or water and a mild detergent.

To clean the case, use a soft cloth that is moist with water or water and a mild detergent.



Do not put the tester or the battery pack in water.



To prevent damage to the touchscreen or the case, do not use solvents or abrasive materials.

When you clean the touchscreen or the case, do not let liquid get under the plastic around the touchscreen.

To clean the optical connectors on a fiber module, see the instructions in Chapter 4.

Clean the FI-1000 Video Probe

To clean the case, use a soft cloth that is moist with a mild detergent.



To prevent damage to the case, do not use solvents or abrasive materials.

To clean the lens, remove the adapter tip, then wipe the lens with an optical-grade cloth that is moist with an optical-grade cleaning solution.

See Information About the Tester

To see information about your tester and attached modules and adapters

On the home screen, tap the **TOOLS** icon, then tap **Version Information**.

To see information about your remote tester

Use DSX or CertiFiber Pro modules and patch cords to connect the main and remote testers together (see Figure 2 on page 16), then tap **REMOTE** on the **Version Information** screen.

Traceable Calibration Period

To make sure that the modules operate within the published specifications for accuracy, have them calibrated at an authorized Fluke Networks Service Center every 12 months. To get information on factory calibration, contact an authorized Fluke Networks Service Center.

To see when the tester last received a factory calibration, tap the **TOOLS** icon on the home screen, then tap **Version Information**.

Update the Software

New software gives you access to new features and the latest test limits and cable types. Software updates are available on the Fluke Networks website.

You can use a PC to install a software update, or connect an updated main unit to a remote or to another main unit to update those units.

You can also use LinkWare Live to download a software update from the cloud to your main tester, then use the main tester and a USB cable to install the update in the remote.

About Versiv and Versiv 2 Update Files

Software update files have these extensions:

- Versiv testers: .cic
- Versiv 2 testers: .ci2

The update files are not interchangeable. LinkWare PC and LinkWare Live let you install only the correct file in your Versiv or Versiv 2 tester.

Use a PC to Update the Software

Caution

To prevent unexpected loss of power, connect the ac adapter to the tester when you update the software.

Note

The software update procedure does not delete the test records, project settings, or user preferences in the tester, but can possibly change the factory-installed cable types or test limits.

- 1 Install the latest version of LinkWare PC software on your PC. LinkWare PC is available on the Fluke Networks website.
- 2 Connect the AC adapter to the tester and connect the Micro USB port on the tester to a type A USB port on the PC. See Figure 120.
- 3 LinkWare PC automatically tells you if new software for the tester is available on the Fluke Networks website, and lets you install the software.

Note

Older versions of LinkWare PC do not start the update procedure automatically. For older versions, you must have the update file on a disk or USB drive and click  to start the update procedure.

- 4 The tester reboots when the update is completed. To make sure the update was installed correctly, tap the **TOOLS** icon on the home screen, tap **Version Information**, then make sure the correct version shows.
- 5 Do steps 2 through 4 again for the remote. On a remote tester, the LEDs show the progress of the installation.

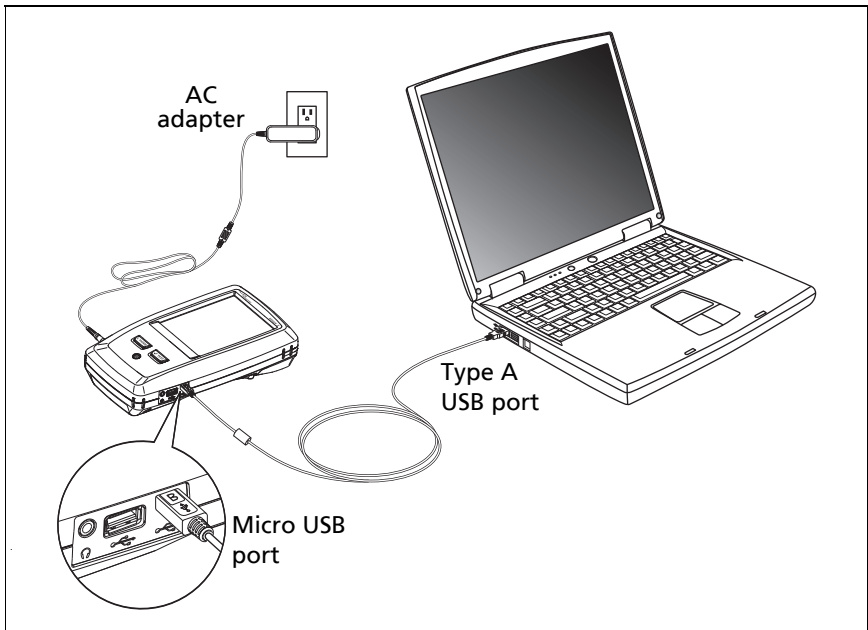

Figure 120. How to Connect the Tester to a PC

GPU46.EPS

Use an Updated Main Tester to Update Other Testers

- 1 Turn on both testers and connect the AC adapters to both testers.
- 2 Use the USB cable provided to connect the updated main unit to the remote or to another main. See Figure 121.
- 3 Follow the instructions shown on the display of the updated main unit.

Note for Versiv remotes

If a remote has newer software than the main unit, the main unit can install the older software in the remote so that you can use the two units together. The remote cannot install the newer software in the main unit.

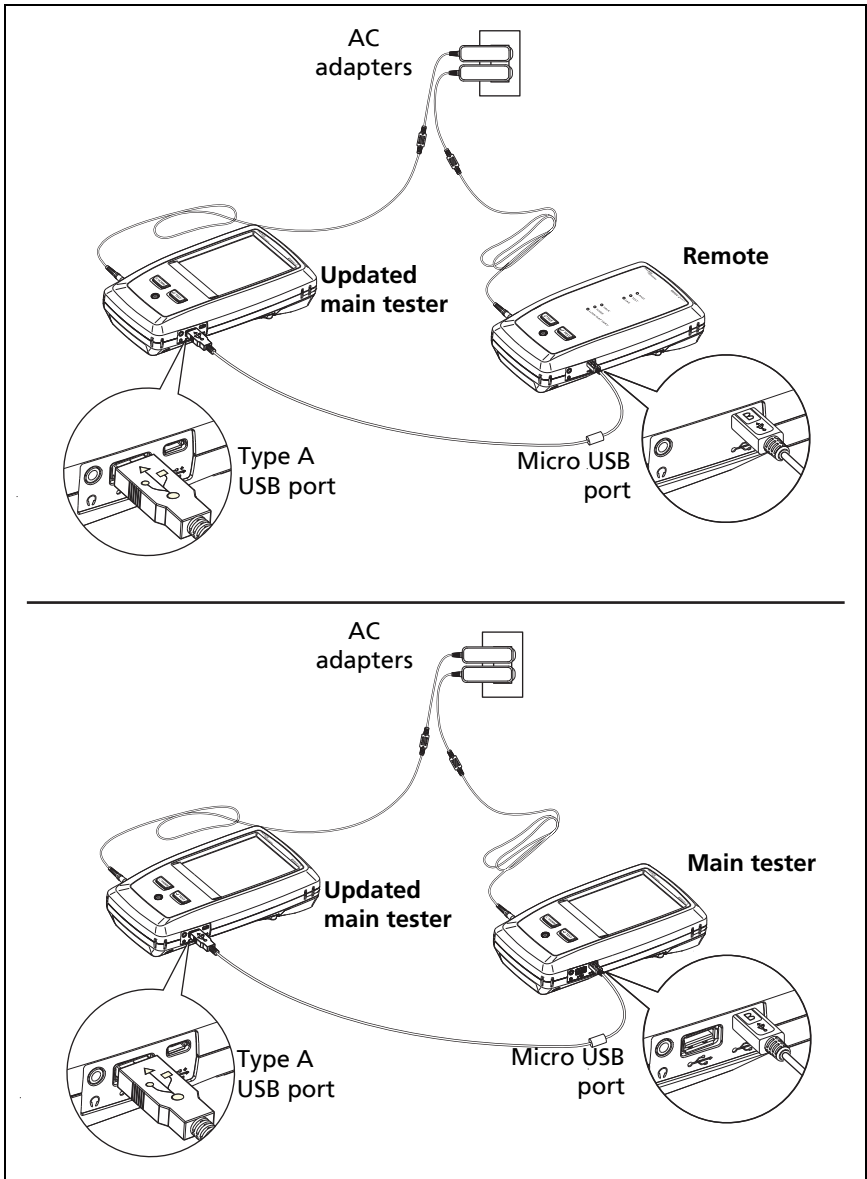

GPU116.EPS

Figure 121. How to Connect Units Together to Update the Software

Use LinkWare Live to Update the Software



- 1 For a wired network: Use an appropriate cable to connect the tester's RJ45 Ethernet port to a network port.
- 2 On the home screen, tap the **SYNC** icon.
- 3 For a Wi-Fi network: If the network selection screen shows, connect to a network:
 - a. Select a network.
 - b. Enter security information.
 - c. Go back to the previous screen, then tap **CONNECT**.
 - d. Go back to the home screen, then tap **SYNC**.
- 4 On the **LWL SIGN IN** screen, enter the ID and password for your LinkWare Live account, then tap **SIGN IN**.
- 5 If a software update is available, the tester shows a message. Tap **YES** to install new software in your tester.
- 6 The tester reboots when the update is completed.
- 7 To install the update in a remote or another main tester, use the USB cable provided to connect the updated main tester to the other tester. See Figure 121.
- 8 Follow the instructions shown on the display of the updated main tester.

Update the Software in a Module

To update the software in a module, attach it to a main or remote tester that has the latest software. The tester automatically installs the software in the module.

Extend the Life of the Battery



To prevent possible fire, electric shock, or personal injury, read the warnings about the rechargeable battery under “ Warning ” on page 5.

- Do not frequently let the battery discharge completely.
- Do not keep the battery at temperatures below -20 °C (-4 °F) or above +50 °C (+122 °F) for periods longer than one week.
- Before you put a battery into storage, charge it to approximately 50 % of full charge.

Store the Tester

- Before you store a tester or an extra battery for a long period, charge the battery to approximately 50 % of full charge. The discharge rate of the battery is 5 % to 10 % each month. Check the battery every 4 months and charge it if necessary.
- Keep a battery attached to the tester during storage. If you remove the battery for more than approximately 24 hours, the tester will not keep the correct time and date.
- Storage temperature: 14 °F to 140 °F (-10 °C to +60 °C)

Remove the Battery

Figure 122 shows how to remove the battery.

Notes

If you remove the battery and do not connect the AC adapter, the clock keeps the current date and time for a minimum of 24 hours.

The screw does not come out of the battery door.

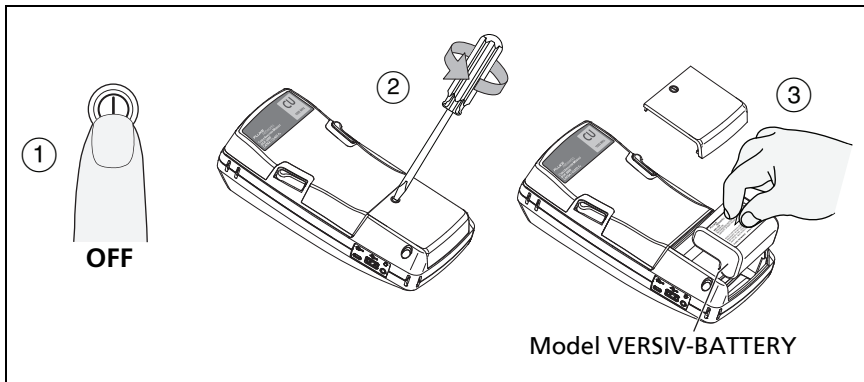

GPU21.EPS

Figure 122. How to Remove the Battery

If the Tester Does Not Operate as Usual

If the tester does not operate as usual or if it shows an unusual message, see Table 11 for possible explanations and solutions to some conditions that can occur.

If the condition continues, contact Fluke Networks for assistance, or search the Fluke Networks Knowledge Base for a solution.

If you contact Fluke Networks, have available the serial number, software and hardware versions, and calibration date for the tester, if possible.

To see this information, tap the **TOOLS** icon on the home screen, then tap **Version Information**. If the tester does not turn on, remove the modules to find the stickers with the serial numbers.

You can also use LinkWare PC software to upload the system log from the tester. This file contains information that can possibly help Fluke Networks find a solution to an unusual problem.

Table 11. Possible Solutions for Unusual Behavior

<p>The touchscreen or the keys do not respond.</p> <p>Press and hold  until the tester turns off. Then turn on the tester. If the problem continues, install the latest version of software in the tester.</p>
<p>The tester will not turn on even though the battery is charged.</p> <p>The safety switch or the fuse in the battery is possibly open. Wait a few seconds, then try again. If the tester does not turn on, the battery is possibly bad and must be replaced. The tester can operate on AC power if the battery does not operate.</p>
<p>Test results appear to be incorrect.</p> <p>The tester possibly has incorrect settings. Make sure you selected the correct cable type and test limit.</p>

Before You Send a Main Tester to a Service Center

Caution

If you send a main tester to a Service Center, make sure you download any test results you must keep to LinkWare Live, LinkWare PC, or to a USB flash drive. Service procedures can possibly delete test results, and Fluke Networks is not liable for lost results.

Options and Accessories

For a complete list of options and accessories go to the Fluke Networks website at www.flukenetworks.com.

To order options and accessories, contact an authorized Fluke Networks distributor.

Appendix A: Reference Method Names

Industry standards use different names for the three reference methods. Tables A-1 and A-2 show the names used in this manual and by four common standards.

Table A-1. Reference Method Names fore TIA/EIA Standards

Link End Connections Included in Loss Results	Method Name in This Manual	TIA-526-14B (multimode)	TIA/EIA-526-7 (singlemode)
2 connections	1 Jumper	One-Cord Reference Method (was Method B)	Method A.1
1 connection	2 Jumper	Two-Cord Reference Method (was Method A)	Method A.2
None	3 Jumper	Three-Cord Reference Method (was Method C)	Method A.3

Table A-2. Reference Method Names for IEC Standards

Link End Connections Included in Loss Results	Method Name in This Manual	IEC 61280-4-1 (multimode)	IEC 61280-4-2 (singlemode)
2 connections	1 Jumper	One-Cord Reference Method (was Method 2)	One-Cord Reference Method (was Method A1)
1 connection	2 Jumper	Two-Cord Reference Method (was Method 1)	Two-Cord Reference Method (was Method A2)
None	3 Jumper	Three-Cord Reference Method (was Method 3)	Three-Cord Reference Method (was Method A3)

Appendix B: Modified 1 Jumper Reference Method

This Appendix shows modified reference and test connections that give 1 jumper results. Use these connections if you need 1 jumper results, but do not have the correct connector adapters to connect the CertiFiber Pro modules' output ports to the link. This method lets you keep the test reference cords connected to the module's output ports when you connect the modules to the link.

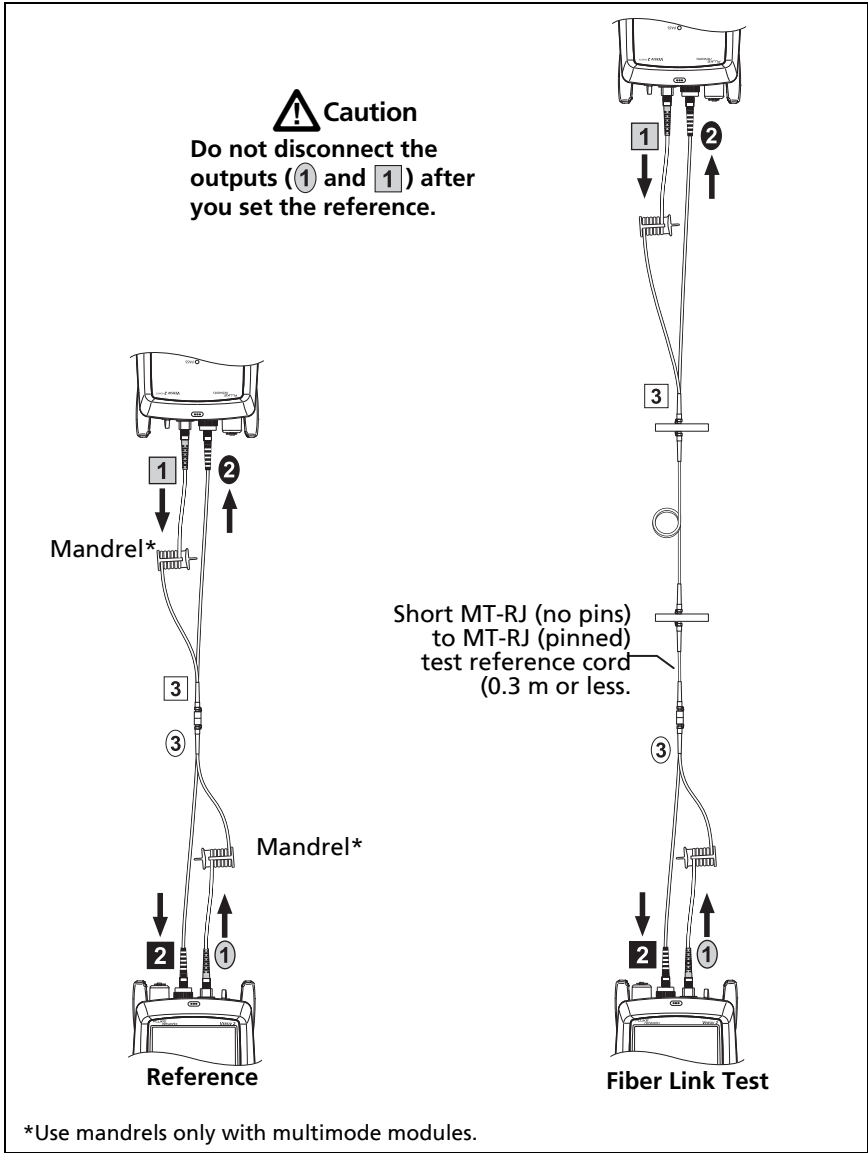

Figure B-1. Modified 1 Jumper Reference Method for Smart Remote Mode