

WILD DRUM CARDER

Create your own fabulous fun and funky art yarns by blending fibres, fabrics, ribbon, feathers, noils, cocoons, paper and more...

Prepare 40gm (1½oz) batts.

Use the adjustable packer brush to smooth and pack more fibre onto the large drum.

Extra long 72 ppsi teeth.

Adjustable drum clearance to suit your fibre.

Rubber feet to stop it from slipping.

Assembled and lacquered - ready to use.

Includes doffer (awl),
cleaning brush and clamps.

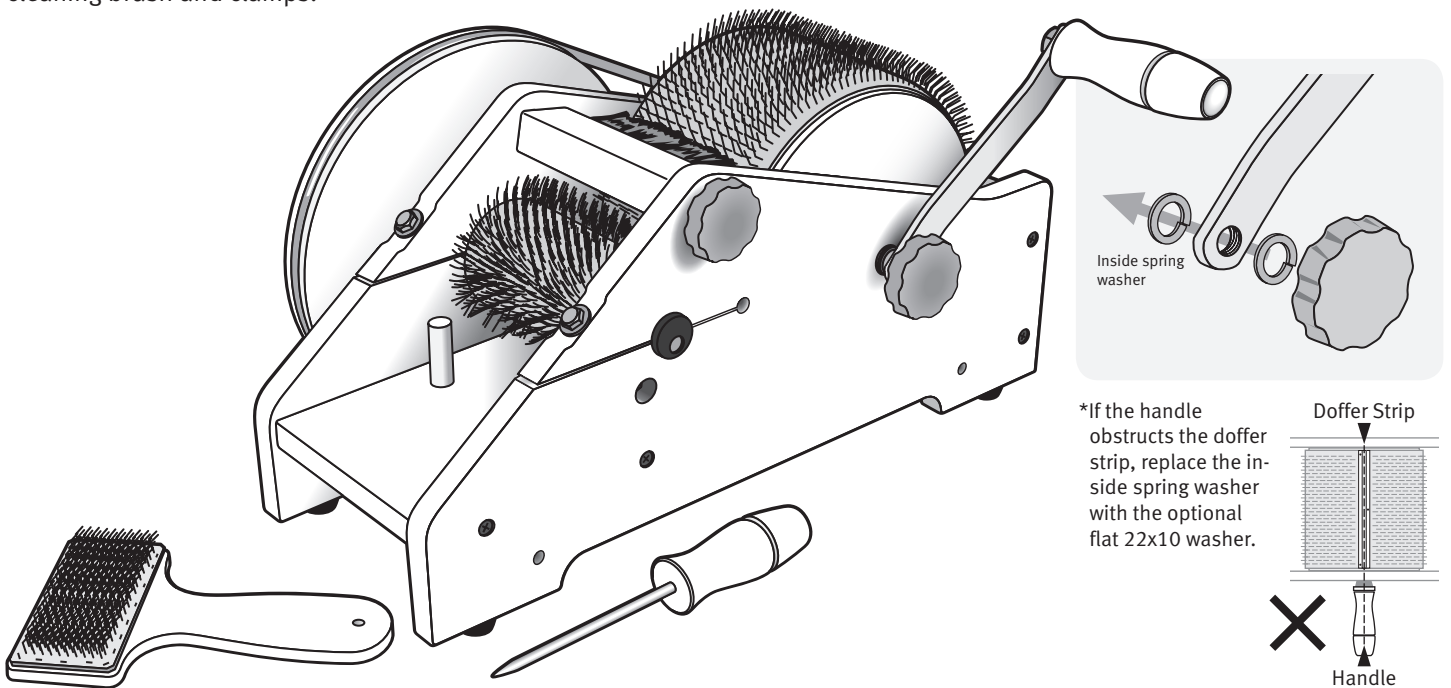

Drive band Doffer (Awl) eyes

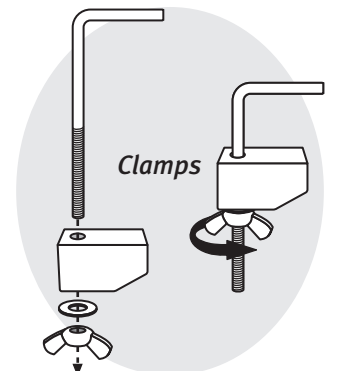
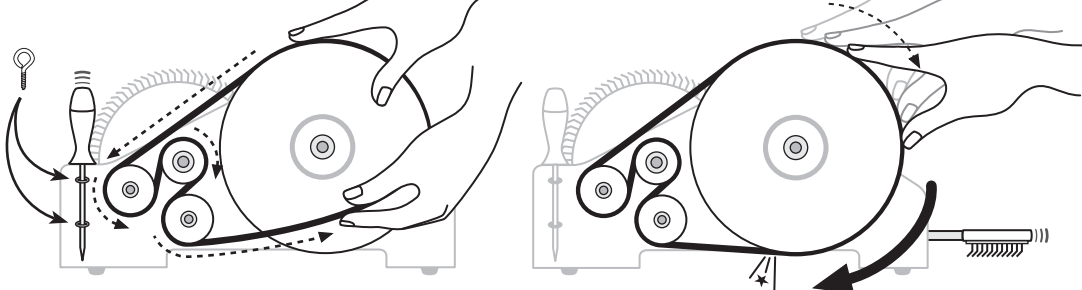

Assembly

Attach the handle as shown. Note: Place a spring washer on first, thread on the handle, the second spring washer and lock in place with the nylon knob. Thread the 2 screw eyes into the holes in the side of the carder. Use them to store the doffer. Place the drive band onto the pulleys as illustrated. When not in use, remove the drive band to avoid it stretching. Store the doffer in the 2 screw eyes on the side of the carder. Store the cleaning brush under the feed-in tray. Assemble the 2 clamps.

Ashford Guarantee

Thank you for purchasing this Ashford product. In the unlikely event there is any fault in manufacture we will replace the item. To validate our guarantee please visit our website or write to us.

How to Use the Wild Carder

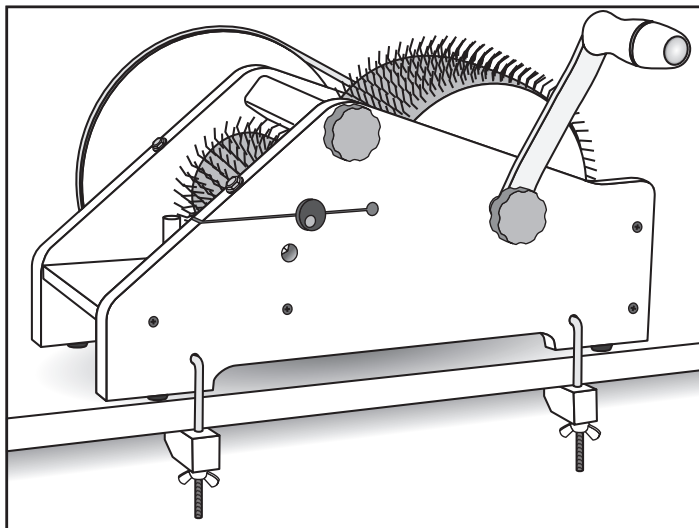

Clamp your Wild Carder to a bench or table.

Fleece - We recommend you lightly wash your fleece prior to carding. Tease the tips of the staples with a flick carder, pull the staple apart sideways, place on the feed-in tray and turn the handle clockwise. Card small amounts of fibre at a time. Allow the fibres to feed-in, don't hold back.

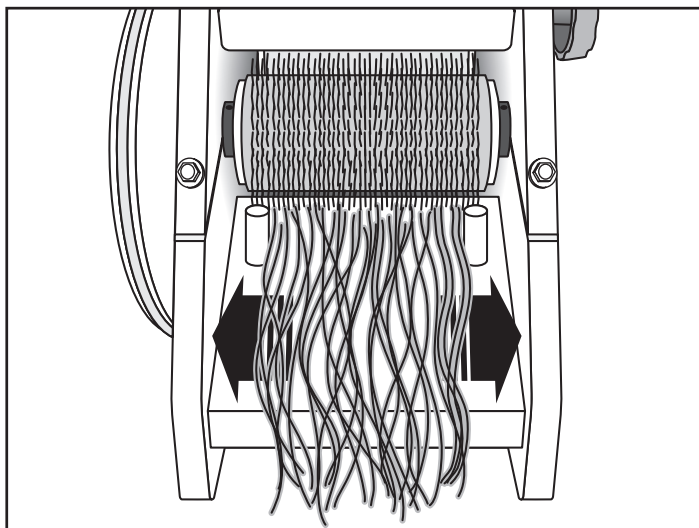

Prepared fibre - Peel sliver into strips, stretch to lengthen and spread it out sideways. Place on the feed-in tray and turn handle clockwise. Allow the fibres to feed-in, don't hold back.

NOTE: For easy carding spread out your fibre as you place on the feed-in tray.

Wild carding - Prepare short pieces of fibre, fabric, ribbon, feathers, noils, cocoons, paper etc. Make a sliver sandwich - Place your embellishments on top and cover with a thin layer of sliver.

Adjust the packer brush to pack the fibres down into the teeth of the large drum.

Once the teeth on the large drum are full of fibre or fibre starts accumulating on the small drum, stop carding.

NOTE: Ensure all fibres remain between the guide pegs on the feed-in tray. This will avoid fibres being caught around the shafts.

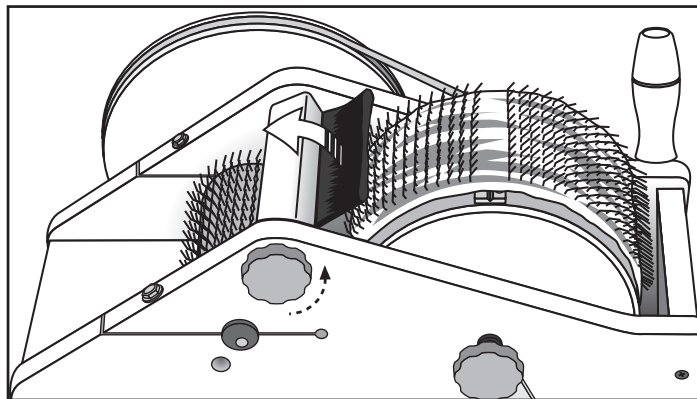

Removing the batt

Loosen the knob holding the packer brush and twist it up off the large drum. Turn the drum until the doffer strip is to the top.

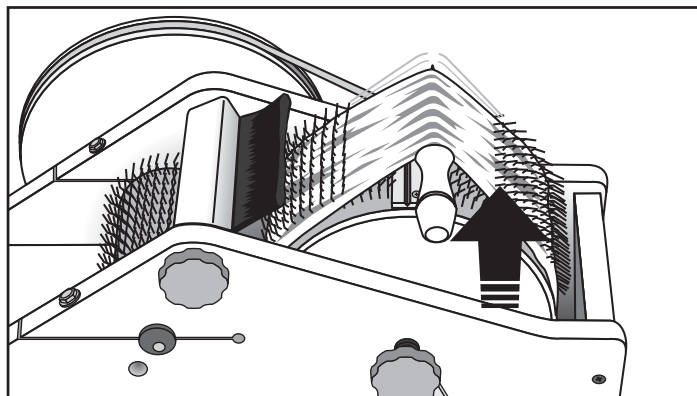

Part the batt with the doffer, taking care the doffer runs in the groove in the doffer strip.

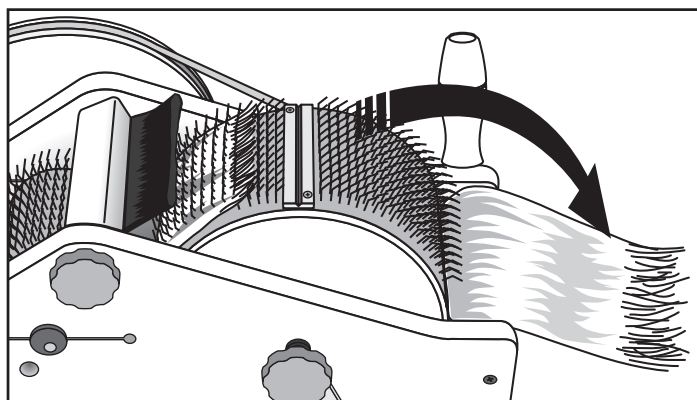

Pull the batt down over the back beam to remove it cleanly from the drum.

Maintenance

Apply a drop of oil occasionally to all bearings. The gap between the teeth may be adjusted to suit your fibre. The carder comes factory set at our recommended spacing of 0-1mm. For fine fibres without bulk, you may use a closer setting or for coarser bulky fibres you may use a slightly wider setting. To adjust the gap, remove the drive band. Loosen the 2 bolts and use the nail supplied to rotate the 2 eccentric bearings. Tighten the 2 bolts and replace the drive band. Always remove the drive band when not in use to avoid it stretching.

For more detailed carding instructions, hints and inspiration, we recommended the *Ashford Book of Carding* by Jo Reeve. It has 92 colourful pages covering flick, hand and drum carding, colour theory and 4 gorgeous projects.

Happy Carding!

WDC010518V6