

FormD
BY
NCASE

Sandwich Kit
Version 2.5

Flatpack Assembly Manual

Flatpack Assembly Manual

Screw-6

M3 Countersunk Screw

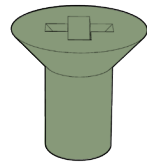

This screw only works for countersunk holes.
This screw allows for a slightly stronger lock.

OR

Screw-5

M3 Flat Sunk Screw

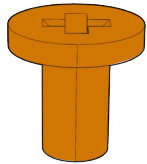

This screw works for most of the steps in this manual.
One screw type makes for an easier build experience.

Standoff-5

M3 Standoff Screw-5

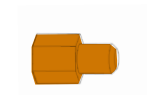

Standoff-6

M3 Standoff Screw-6

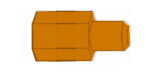

Standoff-10

M3 Standoff Screw-10



Standoff-20

M3 Standoff Screw-20



Standoff-30

M3 Standoff Screw-30



Standoff-40

M3 Standoff Screw-40



ThumbScrew-10

M3 ThumbScrew

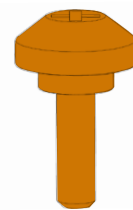

Flatpack Assembly Manual

Extra Accessory

- 15 Fan + Radiator Strut
- 16 Fan + Radiator Bracket
- 17 Glass Window Panel

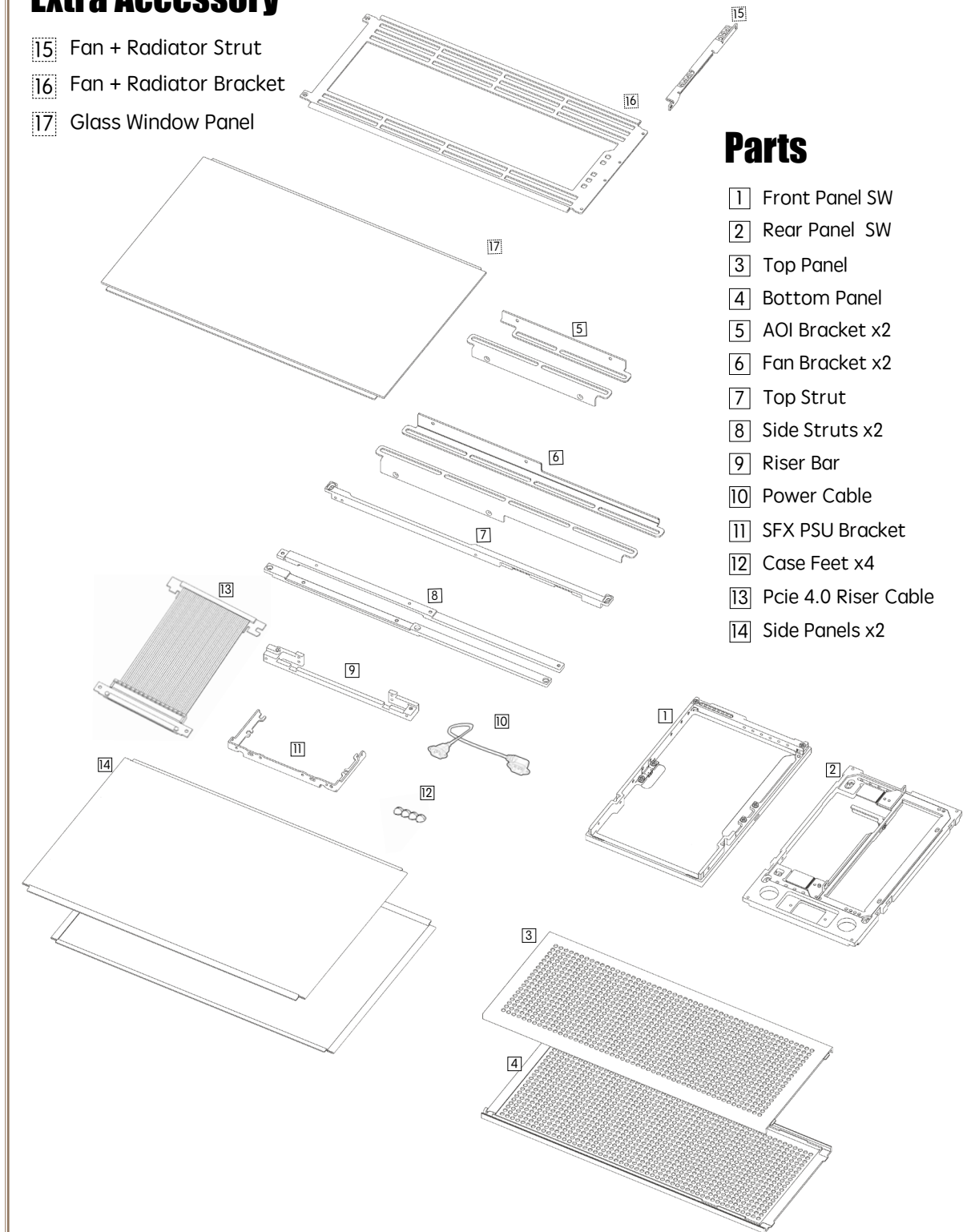

Parts

- 1 Front Panel SW
- 2 Rear Panel SW
- 3 Top Panel
- 4 Bottom Panel
- 5 AOI Bracket x2
- 6 Fan Bracket x2
- 7 Top Strut
- 8 Side Struts x2
- 9 Riser Bar
- 10 Power Cable
- 11 SFX PSU Bracket
- 12 Case Feet x4
- 13 Pcie 4.0 Riser Cable
- 14 Side Panels x2



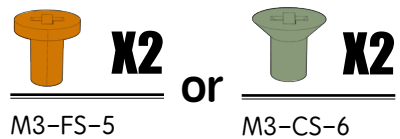
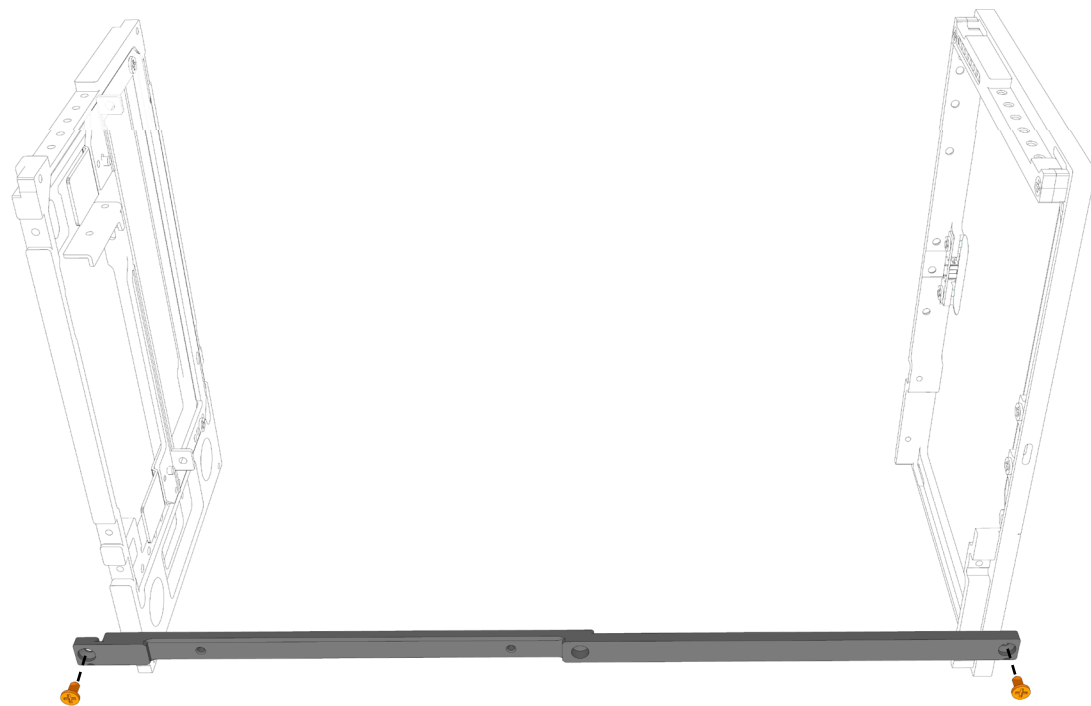



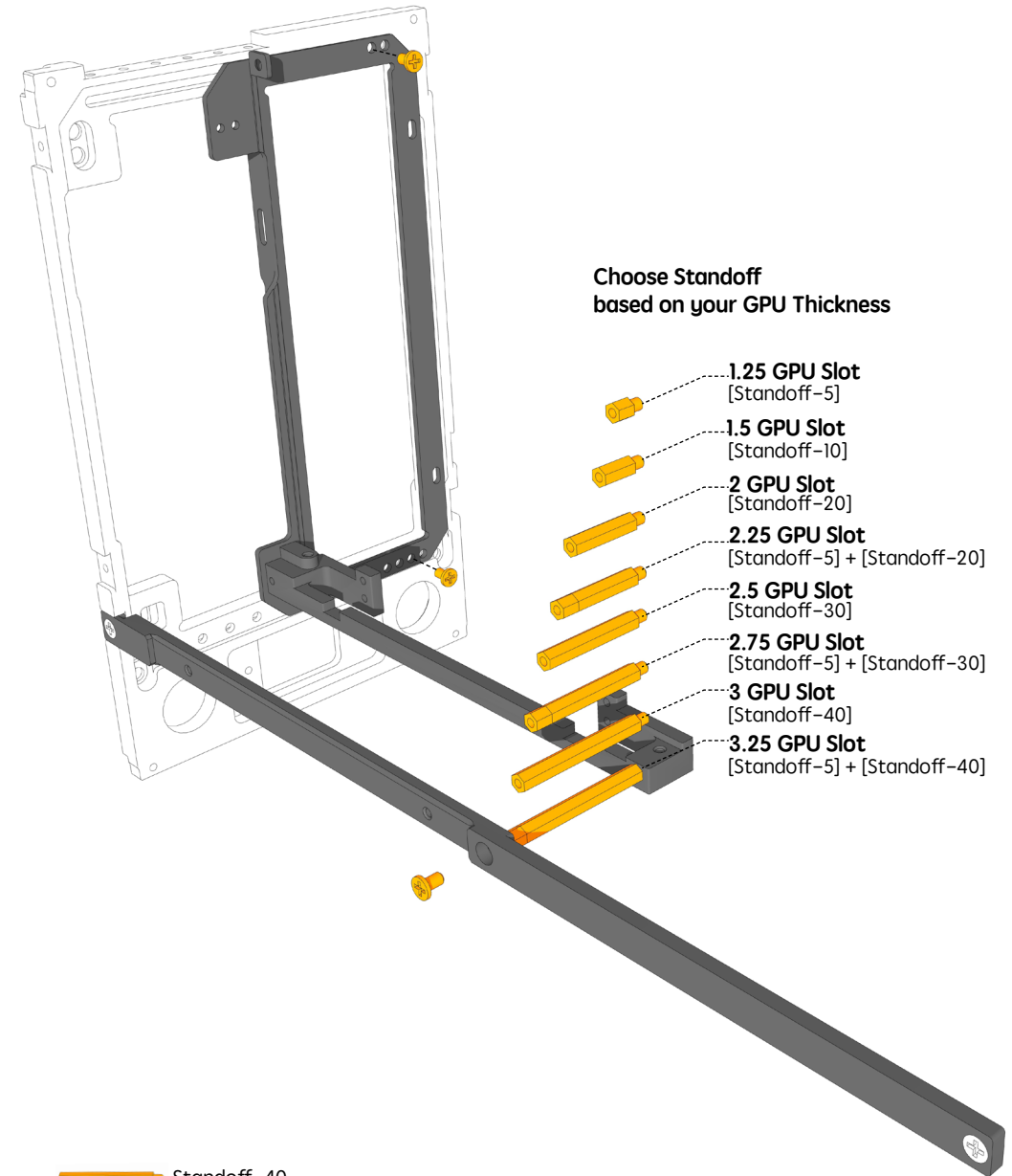

Flatpack Assembly Manual







Flatpack Assembly Manual



Choose Standoff based on your GPU Thickness

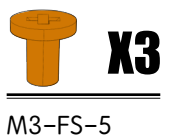

-  1.25 GPU Slot [Standoff-5]
-  1.5 GPU Slot [Standoff-10]
-  2 GPU Slot [Standoff-20]
-  2.25 GPU Slot [Standoff-5] + [Standoff-20]
-  2.5 GPU Slot [Standoff-30]
-  2.75 GPU Slot [Standoff-5] + [Standoff-30]
-  3 GPU Slot [Standoff-40]
-  3.25 GPU Slot [Standoff-5] + [Standoff-40]

-  Standoff-40
-  Standoff-30
-  Standoff-20
-  Standoff-10
-  Standoff-5



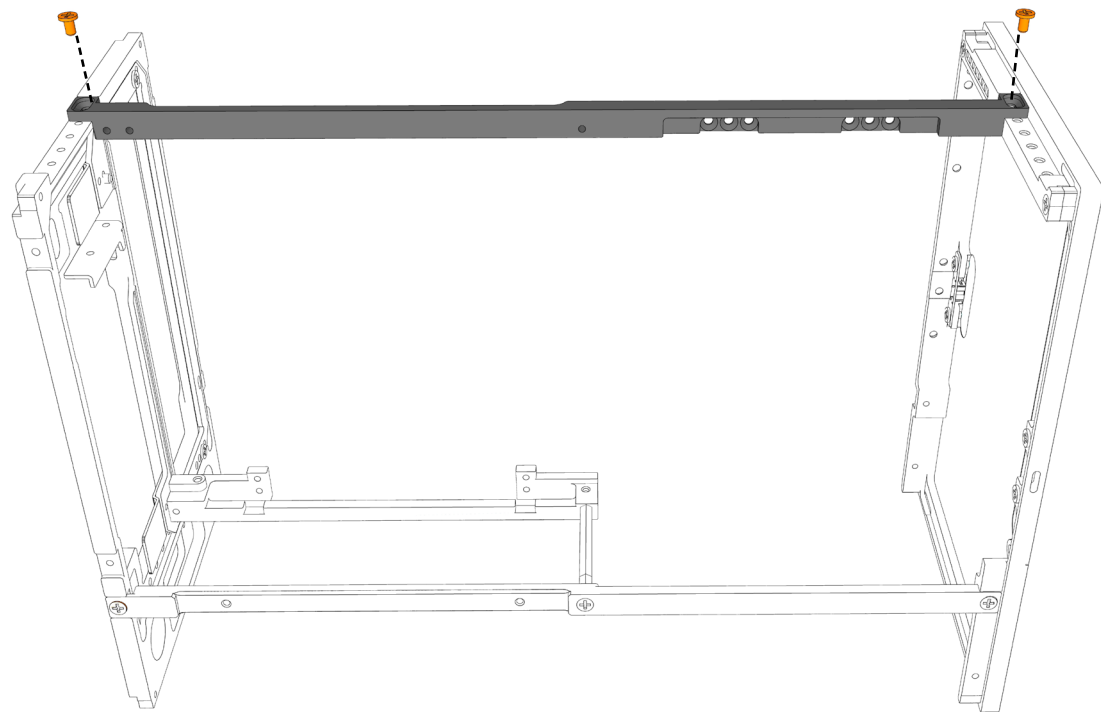

Flatpack Assembly Manual

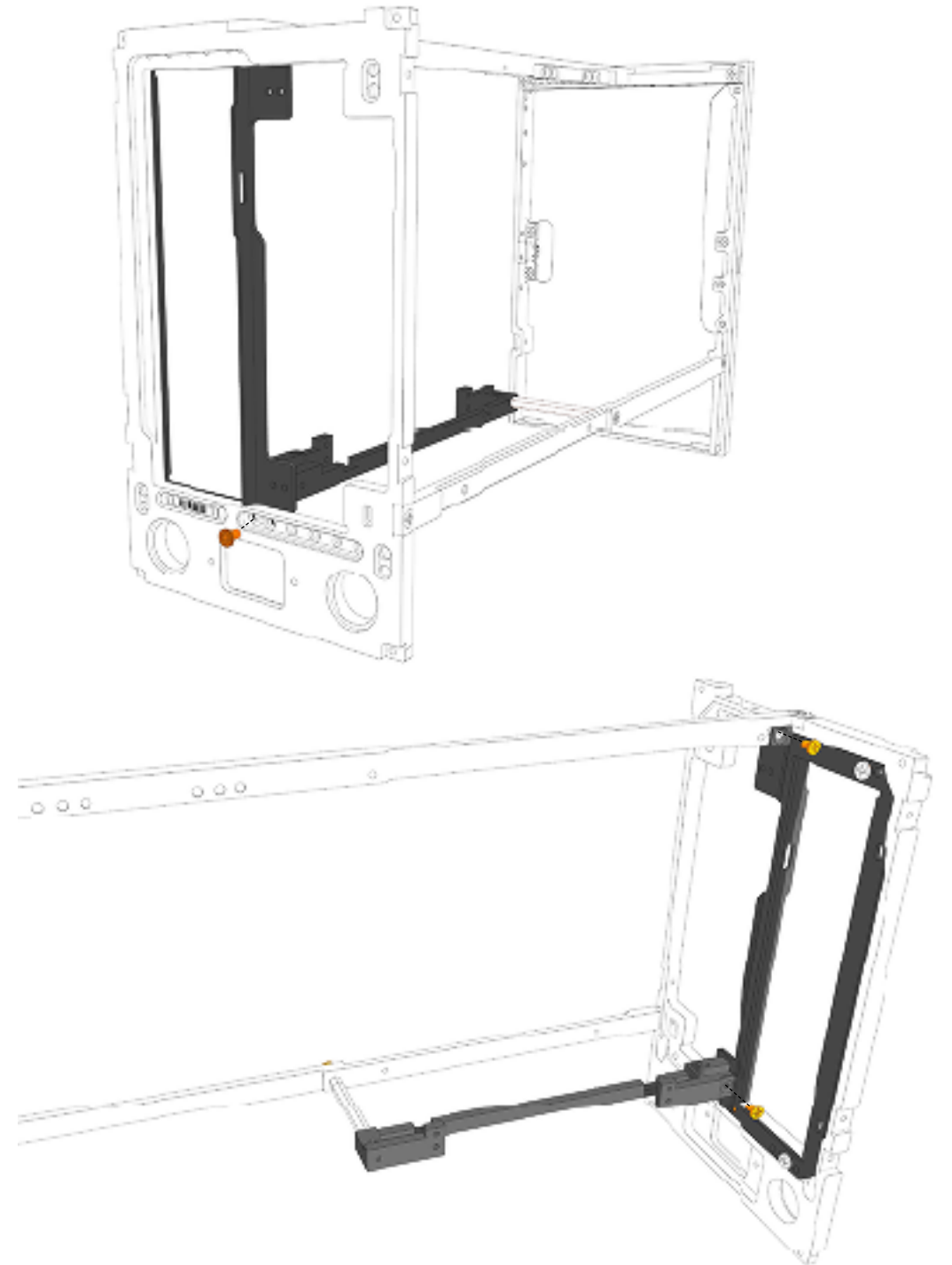

 **X2** or  **X2**
M3-FS-5 or M3-CS-6

Flatpack Assembly Manual



 **X3** or  **X3**
M3-FS-5 or M3-CS-6

Flatpack Assembly Manual

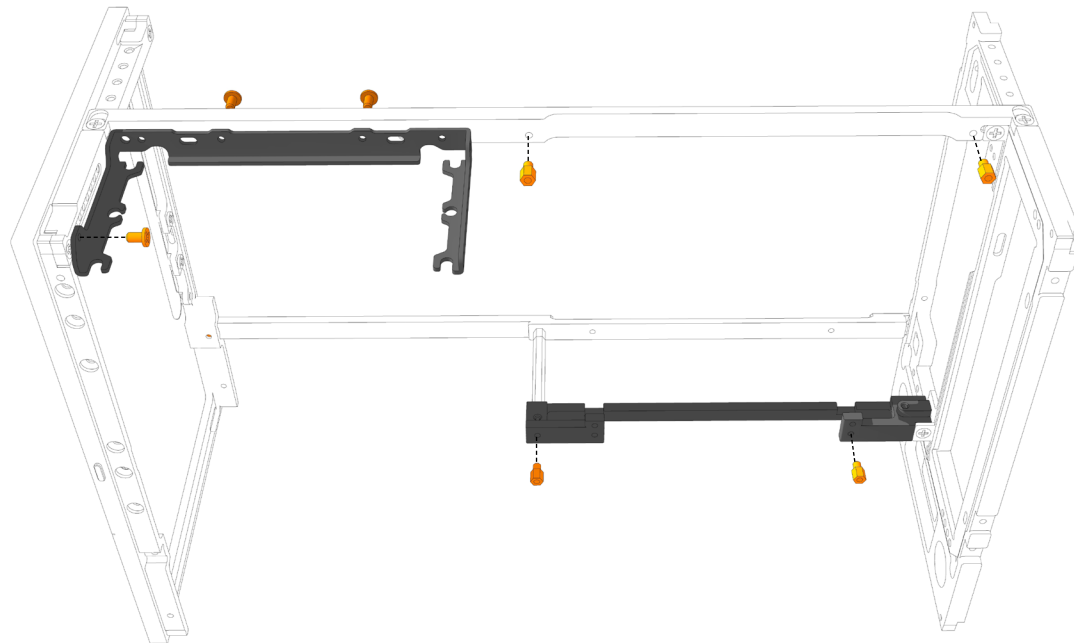

X4

M3-S-6



X3

M3-FS-5

Flatpack Assembly Manual

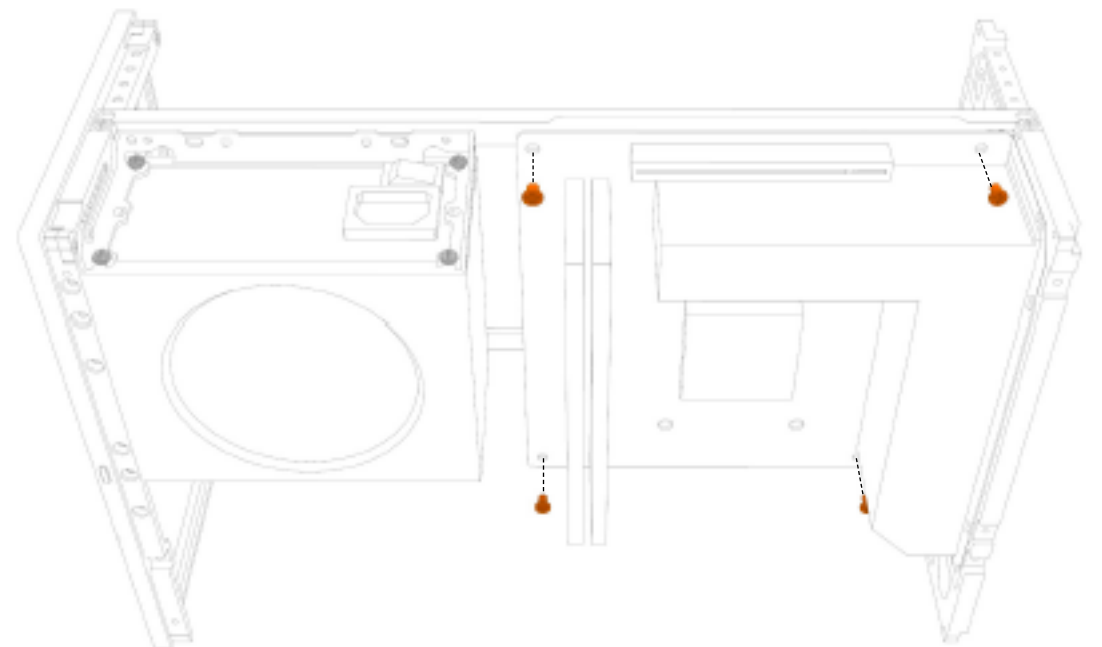

X4

M3-FS-5



#6-32 screw for the power supply installation is not included.

Flatpack Assembly Manual

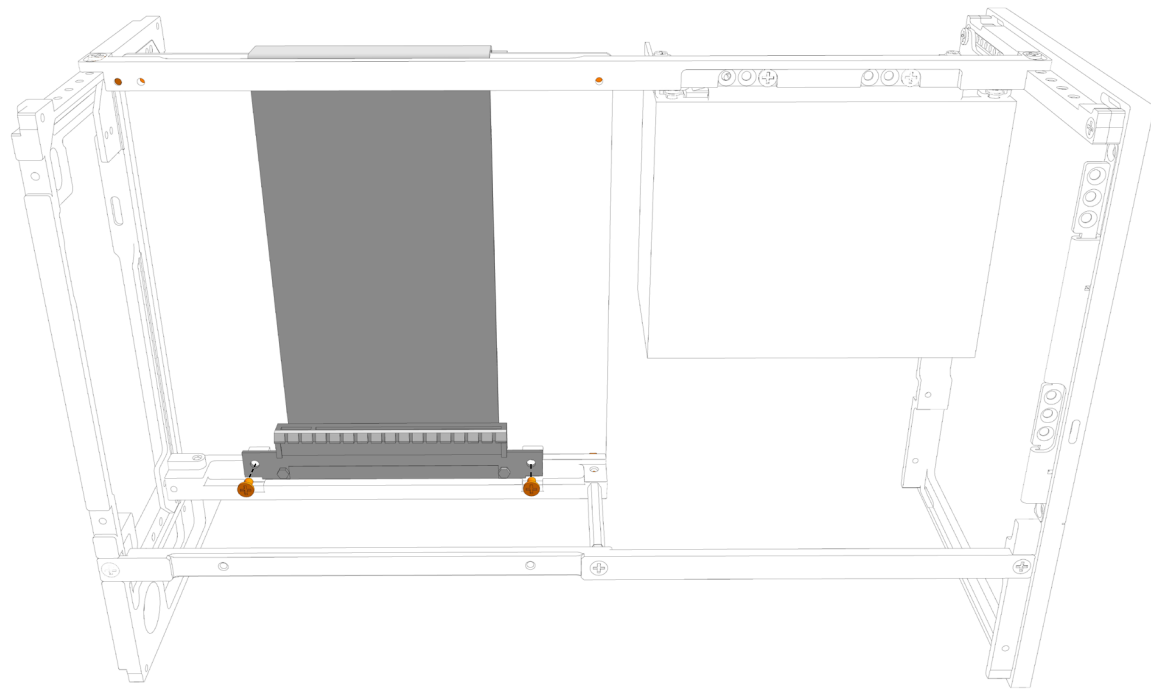

 **X2**
M3-FS-5

Flatpack Assembly Manual

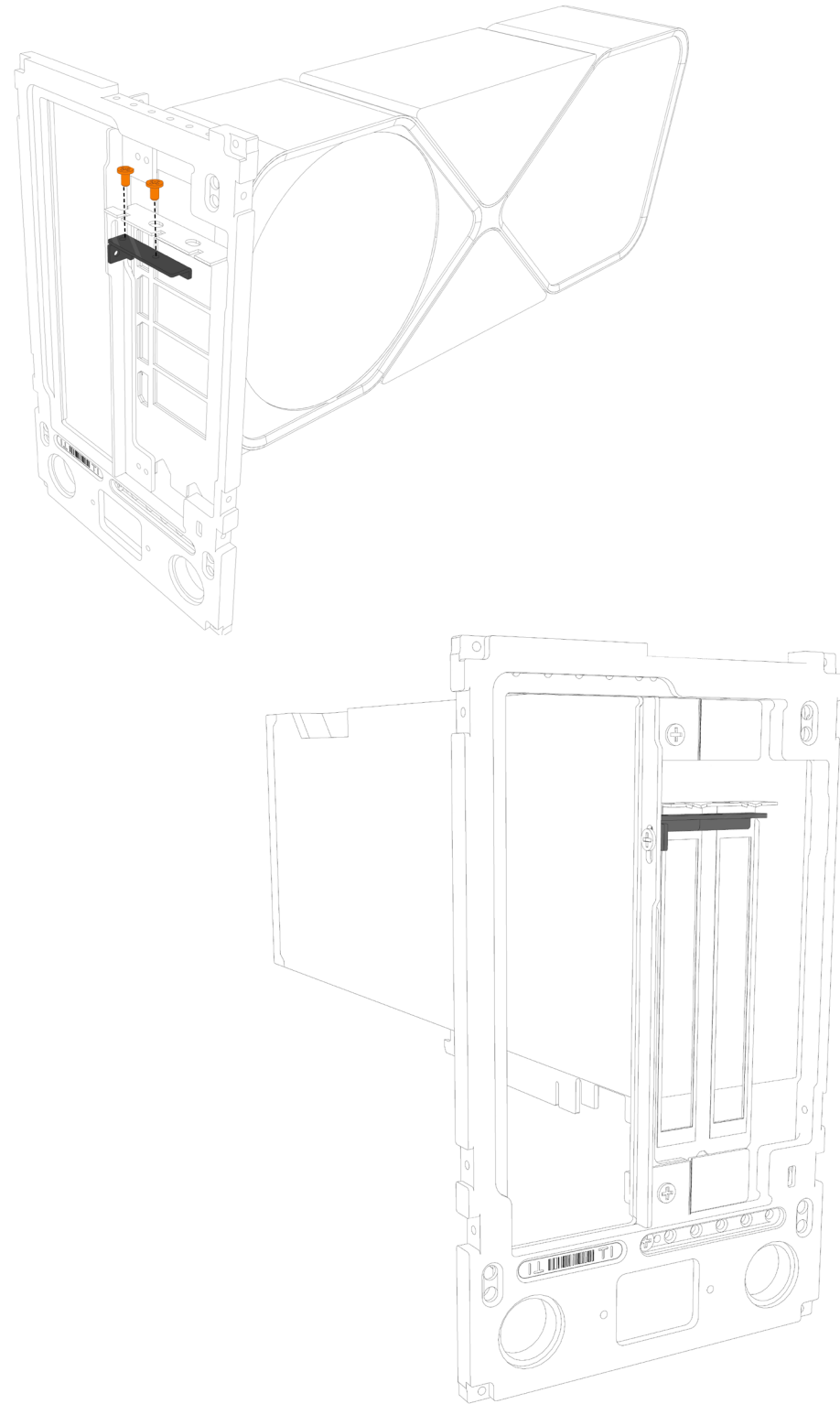

 **X2**
M3-FS-5

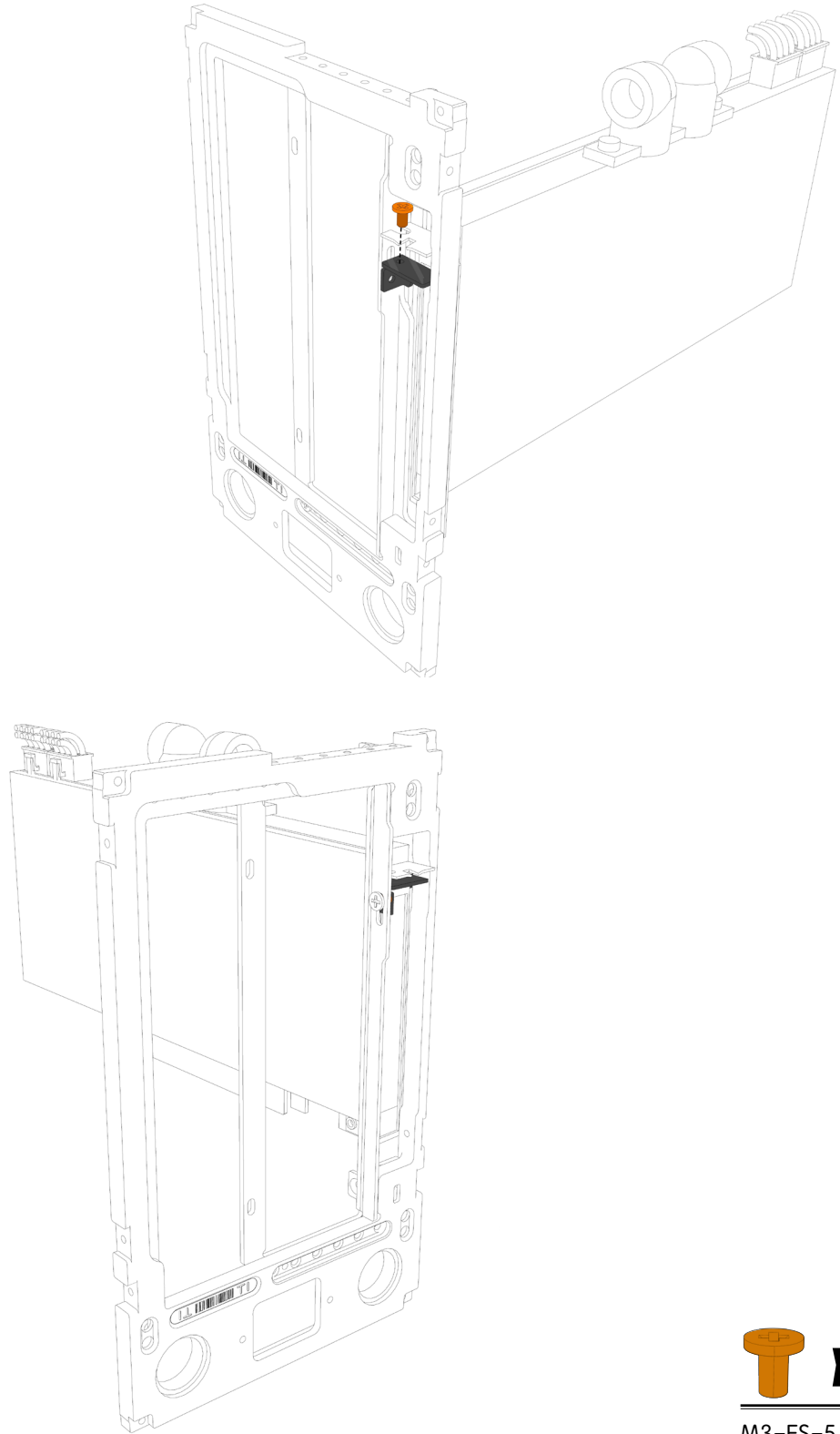

Flatpack Assembly Manual



 **X1**
M3-FS-5

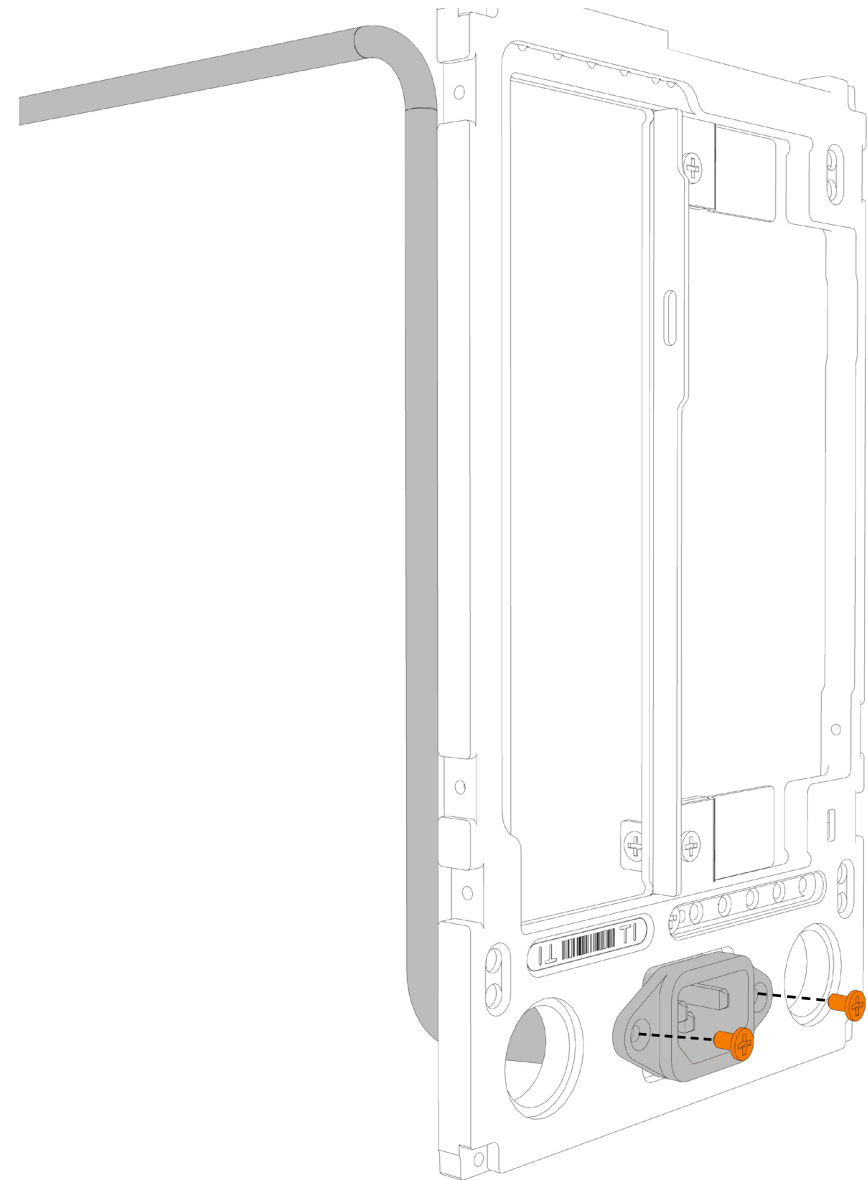

Flatpack Assembly Manual



 **X2** or  **X2**
M3-FS-5 M3-CS-6

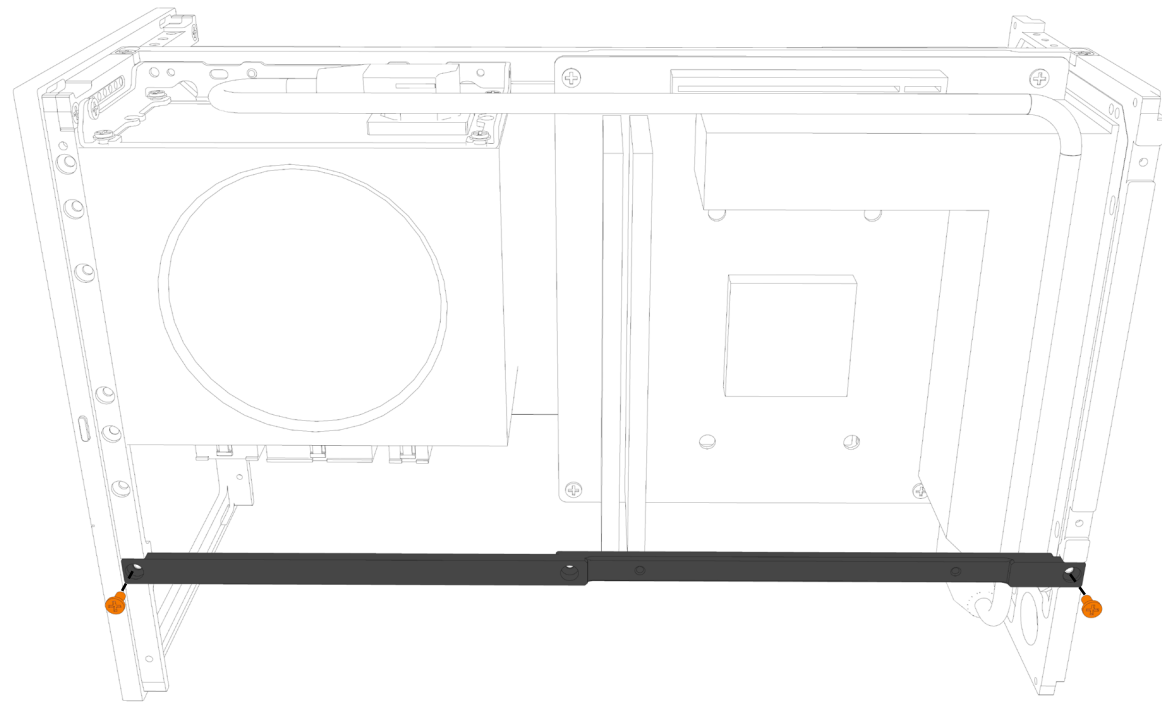

Flatpack Assembly Manual

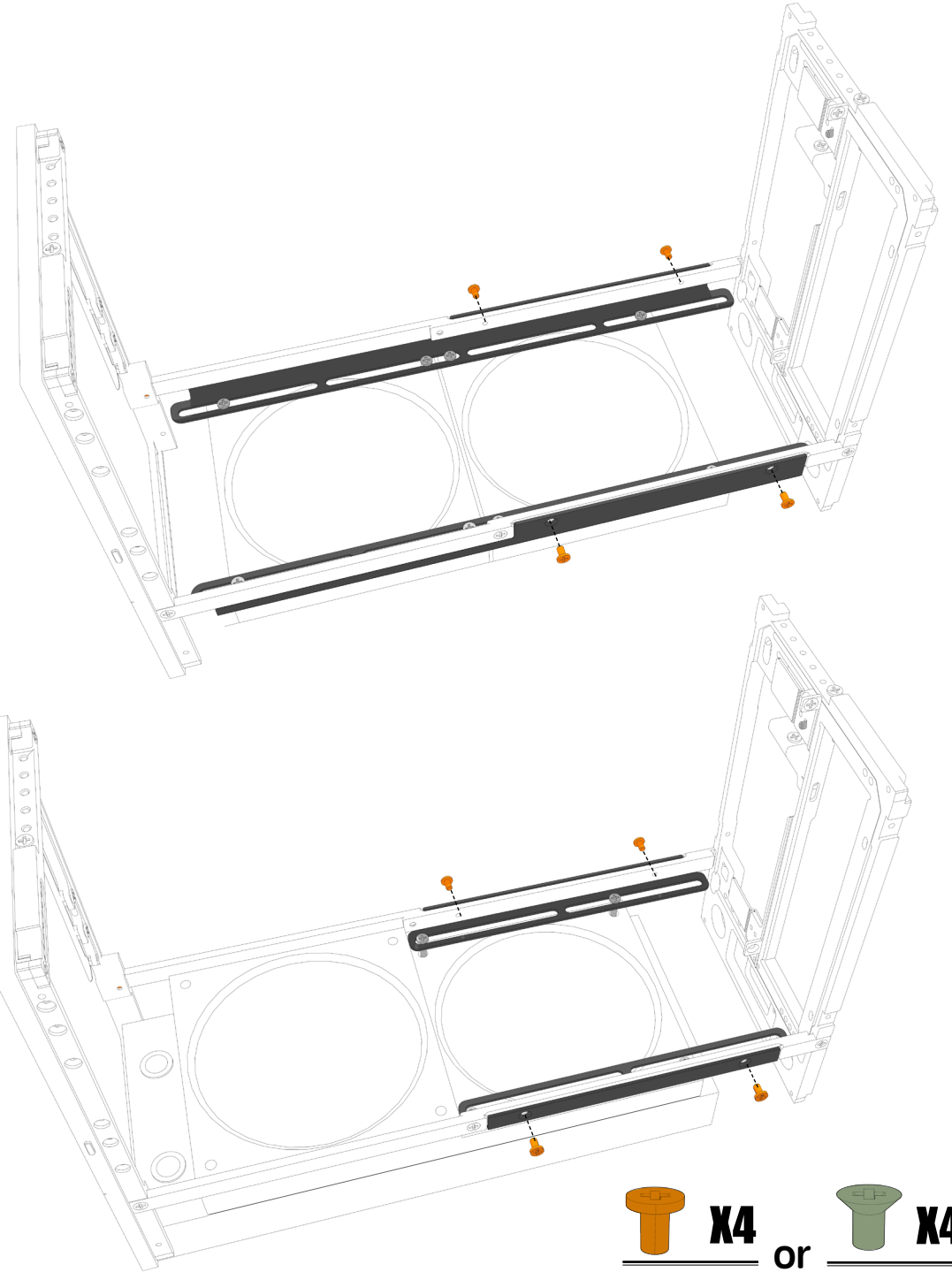

 **X2** or  **X2**
M3-FS-5 M3-CS-6

Flatpack Assembly Manual



 **X4** or  **X4**
M3-FS-5 M3-CS-6

**M5 x 8 screw for
the fan installation
is not included.**

Flatpack Assembly Manual

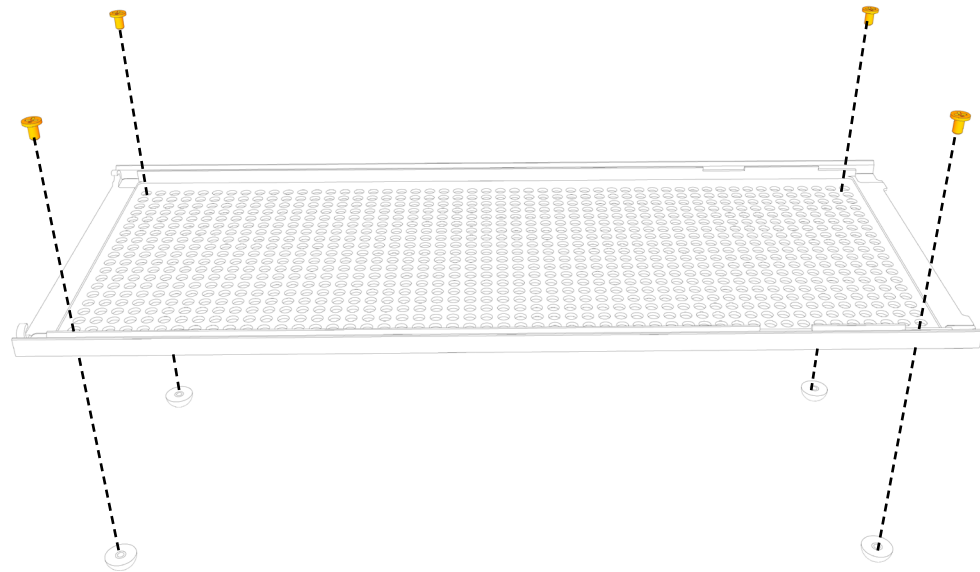

 **X2**
M3-FS-5

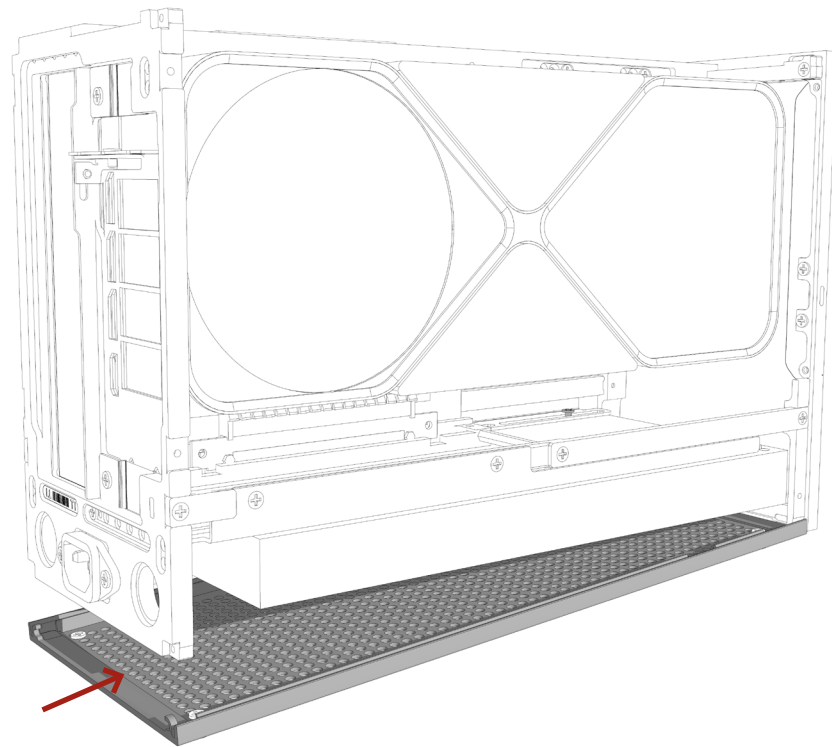

Flatpack Assembly Manual

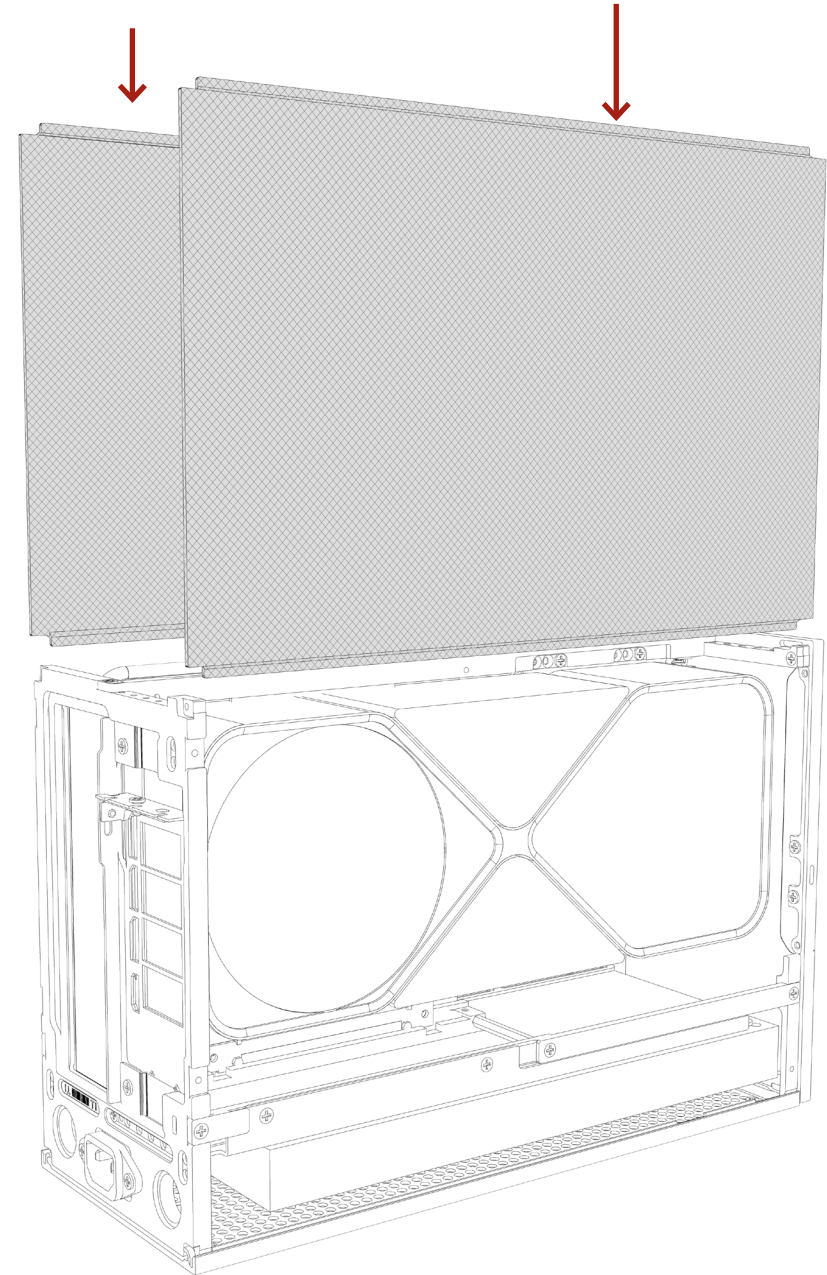

Flatpack Assembly Manual

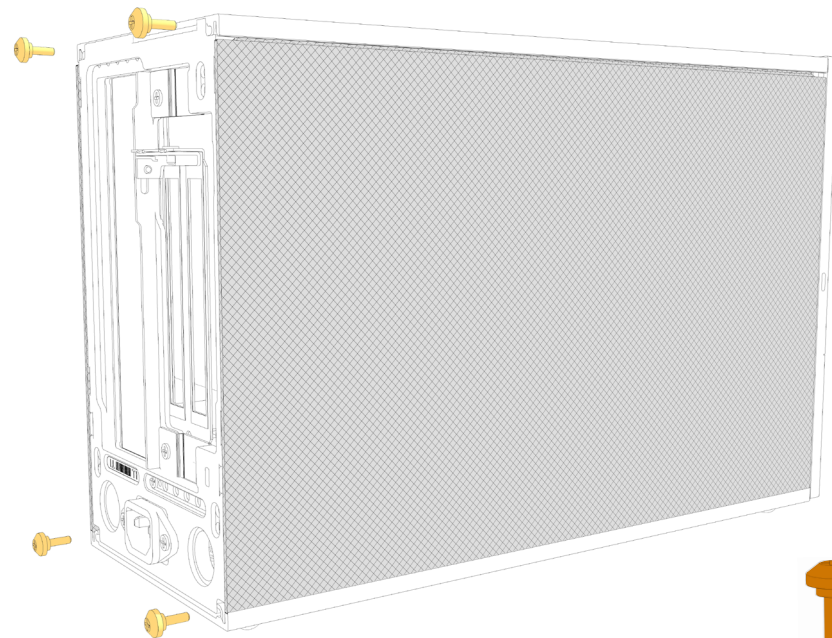
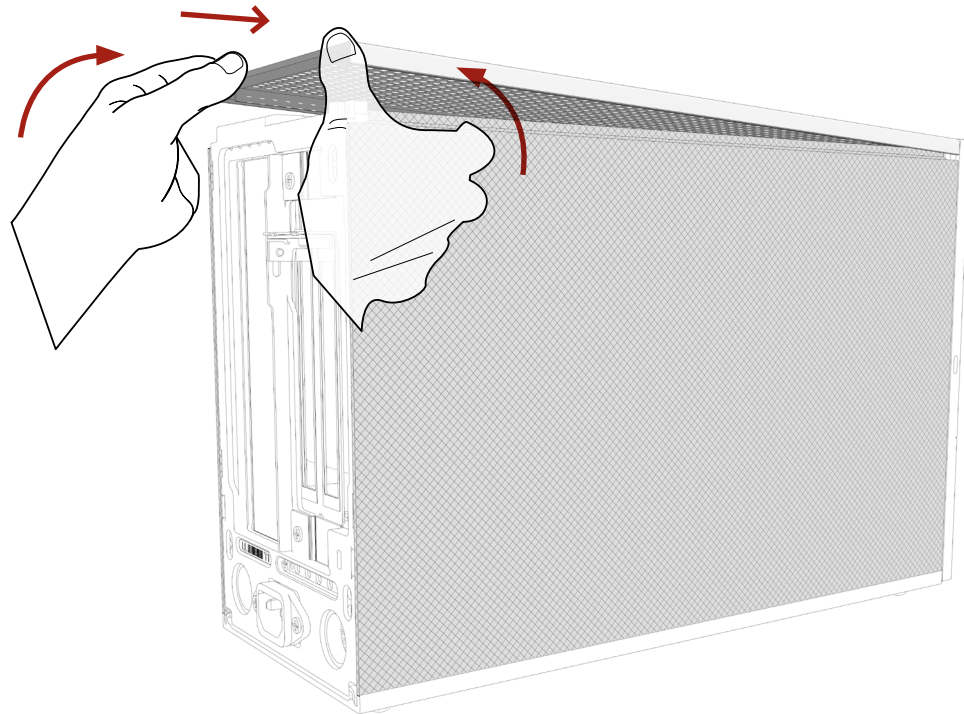

M3-TB-10

NCASE

T1 Sandwich Kit Version 2.5