

**joval**  
MADE IN GERMANY

twenty eighteen

**joval** MADE IN GERMANY

## REBAR

Foldable  
Shelving System

2013

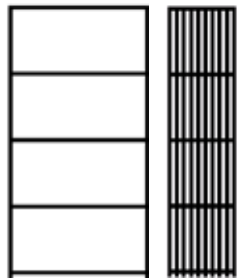

## PLEKTRON CHRONOS

Coffee Table

2013



Coffee Table  
Side Table

2014

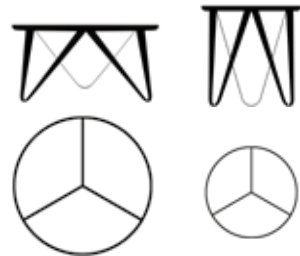

## HELIOS

Foldable  
Table Frame

2016

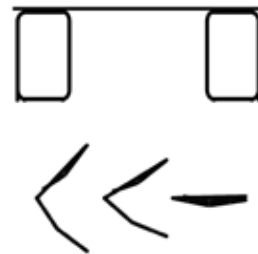

## LEITO

Side Tables

2016



## SOMOS

Side Table

2017



## DOSNIVELES

Coffee Table  
Side Table

2017



# COLLECTION 2018



joval celebrates its 5th anniversary in 2018 and stands more than ever for beautifully designed and perfectly finished couch and side tables and the foldable shelving system REBAR. We present our collection with new products, new materials and new colours - in accordance with our philosophy of manufacturing timelessly beautiful furniture with special aesthetics, well thought-out functionality and long-lasting German quality.

We aim to offer something special with our designs - furniture that impresses with its feel, appearance and function. That is why we continuously work on innovations with contemporary lines and strong expression - every detail of our designs should delight the viewer: today, tomorrow and for many years to come. In 2018, we are expanding our collection to include the graceful yet practical sofa and side table series DOSNIVELES and SOMOS. They complement our successful coffee table and side table series CHRONOS & PLEKTRON and LEITO and our award-winning folding shelving system REBAR and folding table frame HELIOS.

The joval collection presents itself in 2018 with robust table tops in timeless black and white complemented by precious solid wood and extravagant gold brass as well as classic hand-polished stainless steel. Our foldable shelving system REBAR will be available in series for the first time in 2018 in one colour/wood.

As usual, all our furniture is made in Germany with the best quality craftsmanship.

Enjoy our catalogue - we are always available for inquiries.

Your joval team from Munich,

Jonas Schroeder

CHRONOS coffee table & side table	6-13
PLEKTRON coffee table	14-17
DOSNIVELES coffee table & side table	18-23
LEITO side table system	24-29
SOMOS side table	30-35
REBAR foldable shelving system	36-45
HELIOS table frame	46-51
Company & Designer	52-55

# CHRONOS & PLEKTRON

Coffee Table & Side Table



**CHRONOS**  
Coffee Table



**CHRONOS**  
Side Table



**PLEKTRON**  
Coffee Table

# CHRONOS & PLEKTRON





PLEKTRON & CHRONOS present themselves as triangular and round side and coffee tables. The central design element are the unique, characteristic curved leg elements, which are made of powder-coated steel or hand-polished stainless steel in an innovative process in the Munich area. PLEKTRON & CHRONOS can be perfectly staged as a combination or individually used as elegant couch, side or night tables in lounge areas, hotel or living rooms.

The design of PLEKTRON & CHRONOS is based on mathematically derived proportions and continuous lines, resulting in the discreet decorative groove in the surface of the coloured table tops.

PLEKTRON & CHRONOS are vibration-free and stable despite the fine leg construction made of steel or hand-polished stainless steel sheet.

The table top from PLEKTRON & CHRONOS is manufactured with a robust powder-coated surface for use in contract environments.

In addition to the white and black versions, the table tops are available in solid oak and walnut with an easy-care natural effect finish.



> 50 <



> 50 <

< 50 >



> 75 <



> 38 <

< 75 >



> 78 <



> 40 <

< 80 >

CHRONÓS



## **MATERIAL & COLOURS**

### **TABLE LEGS**

Matt powder-coated sheet steel in Jet Black (RAL 9005) or Pure White (RAL 9010) or glossy hand-polished stainless steel plate

Felt protectors to protect the floor

### **TABLE TOP**

Dimensionally stable MDF board with robust powder-coating in Jet Black (RAL 9005) or Pure White (RAL 9010) matt

Table top also available in fine, beautifully assorted, and perfectly handcrafted solid oak or walnut wood from sustainable forestry.



**joval**

# CHRONOS Solid Wood



The CHRONOS side table and coffee table in solid wood combines the timeless elegance of the geometric lines of the curved steel leg elements with the warmth and pleasant feel of solid wood. The CHRONOS solid wood tables are handcrafted in Germany from carefully selected wood from sustainable forestry.

The oak comes from FSC and PEFC certified cultivation from Germany and neighbouring countries, the wood of the walnut tree from sustainable forestry in American forests.

Thanks to the robust and matt finish of the surface, CHRONOS solid wood tables are a long-lasting pleasure for eyes and hands.



CHRONOS Solid Oak hand-polished stainless steel glossy

PLEKTRON





PLEKTRON Reinweiß Edelstahl handpoliert glänzend

## MATERIAL & COLOURS

### TABLE LEGS

Matt powder-coated sheet steel in Jet Black (RAL 9005) or Pure White (RAL 9010) or glossy hand-polished sheet stainless steel

Felt protectors to protect the floor

### TABLE TOP

Dimensionally stable MDF board with robust powder-coating in Jet Black (RAL 9005) or Pure White (RAL 9010) matt

Table top also available in noble, beautifully assorted, and perfectly handcrafted solid oak or walnut wood from sustainable forestry



# PLEKTRON Solid Wood

The PLEKTRON coffee table in solid American walnut or oak wood with 6cm wide, continuous wooden panels is perfectly crafted - and combines the warmth of natural wood with the graceful design of the leg elements made of powder-coated steel or hand-polished stainless steel.



PLEKTRON Solid Walnut hand-polished stainless





PLEKTRON Solid Oak Pure White Matt

# DOSNIVELES

Coffee Table & Side Table



joval

# DOSNIVELES



DOSNIVELES Coffee Table Pure White matt

As a special highlight of the new joval collection, DOSNIVELES presents itself as another functional-aesthetic combination of side table and coffee table.

DOSNIVELES impresses with two superimposed table tops in reverse arrangement: the smaller table top on the upper and the larger table top on the lower level. DOSNIVELES offers a lot of space for books and decorative accessories on two levels - or „dos niveles“ in Spanish - with particularly easy access to the lower level.

The distance between the table tops of both tables in relation to the table height is arranged in the golden section, the edges of the table tops are rounded for a smooth touch and feel.

DOSNIVELES table tops are manufactured in southern Germany with a durable powder-coated surface in black and white. DOSNIVELES is perfectly suited for long-term use in hotel and living rooms or lounges in companies of all kinds.



joval

# DOSNIVELES



## MATERIAL & COLOURS

### TABLE TOP

Dimensionally stable, rounded MDF panel powder-coated with a pleasant and durable fine-structure finish in Jet Black RAL 9005 or Pure White RAL 9010

The powder coating is robust and environmentally friendly

### TABLE LEGS

Matt powder-coated steel wire in Jet Black RAL9005 / Pure White RAL9010 or silk gloss in gold brass

The powder coating is robust and environmentally friendly.

## MEASUREMENTS

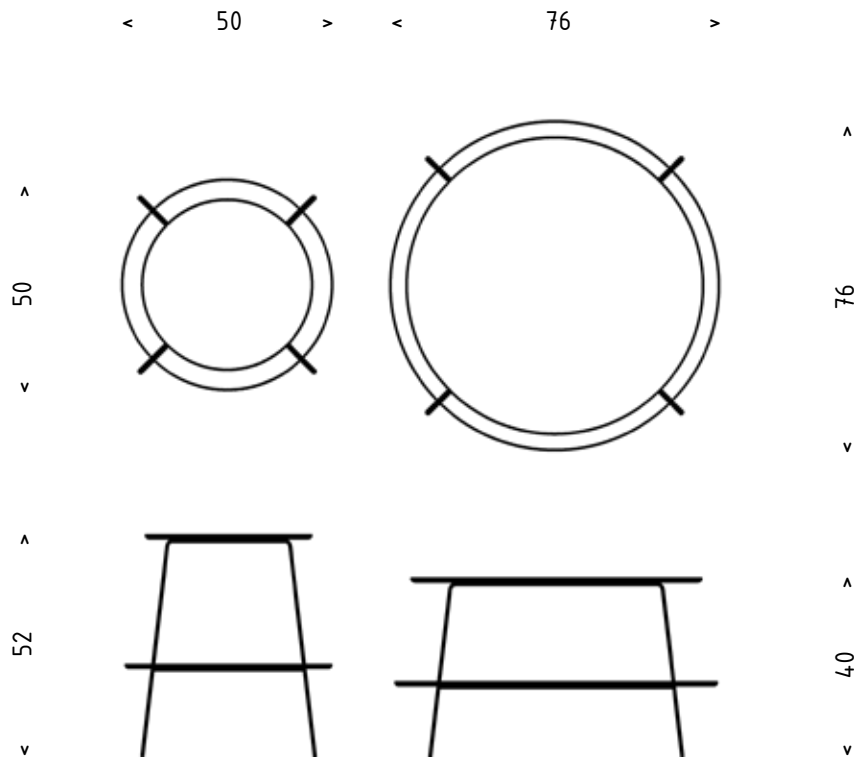

>  
76  
<  
>  
40  
<



DOSNIVELES Jet Black Gold-Brass silk glossy

**joval**

# LEITO

Side Tables





**LEITO**



LEITO's are beautiful small side tables and fit wonderfully in all living areas - whether as a decorative and practical side table in the living room or corridor or as a night table in the bedroom.

The special feature of the LEITOs are their folded table tops made of thin powder-coated steel sheets: The bending stabilises the top, protects objects from falling down and draws a triangular or square graphic on the surface.

LEITOs are manufactured in Bavaria with precise laser technology. The environmentally friendly and robust powder-coating takes place in a workshop for disabled in Munich.

LEITOs are available in three heights 30cm, 40cm and 50cm, in the two shapes three-round and four-round and in the three colours black, white and gold brass.



**LEITO Circle**



**LEITO Triangle**

# LEITO

## MATERIAL & COLOURS

Table top: sheet steel powder-coated with fine structure Pure White (RAL 9010), fine structure Jet Black (RAL 9005) or satin glossy gold brass

Legs: powder-coated tubular steel in the same colours

The powder coating is robust and environmentally friendly

Foot glides: Plastic



## TYPE PLAN

### LEITO Triangle

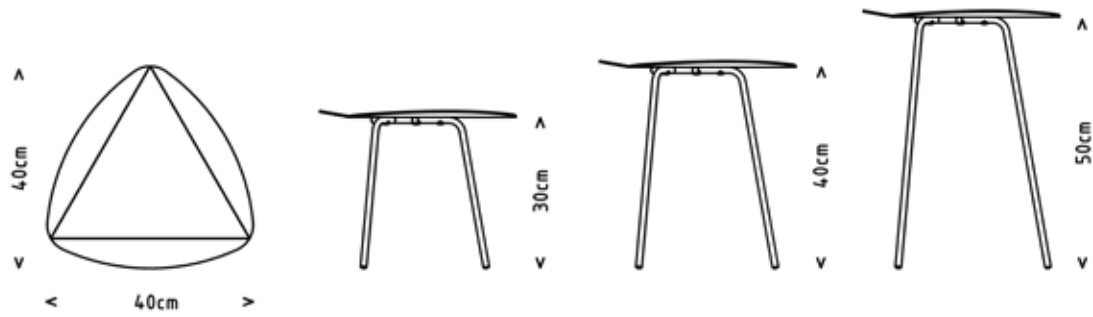

### LEITO Circle

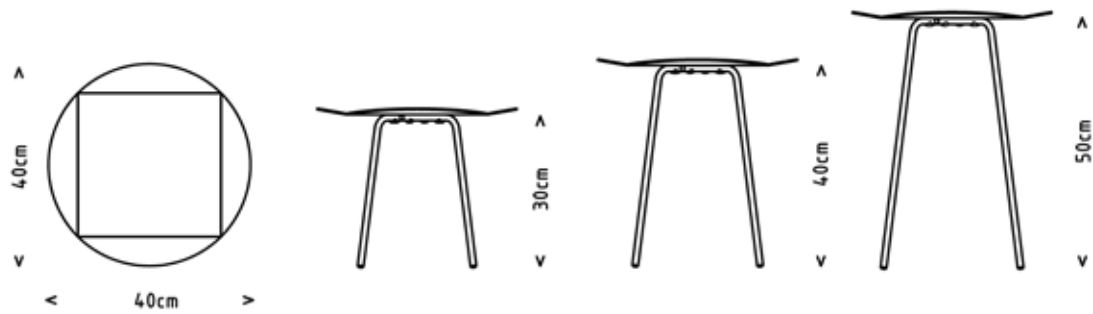

joval

# SOMOS

Side Table



joval

**SOMOS**





SOMOS means "we are" in Spanish. It stands for what the SOMOS tables are - small and fine side tables that reduce themselves to the essentials: A solid wood table top made in the best handcrafted quality with continuous lamellas, and a pleasantly rounded edge lies on fine legs of tubular steel, which are bent in Northern Bavaria and powder-coated in a workshop for the disabled in Munich.

We find: These are excellent ingredients for a beautiful side table.

SOMOS gets a pinch of extravagance through the gold brass leg elements, which harmonize beautifully with the walnut or oak top.

For those who like it more classic, combines the table tops with legs in fine structure Pure White or Jet Black.



**SOMOS Walnut**



**SOMOS Oak**

# SOMOS

## MATERIALS & COLOURS

Table top: Carefully selected walnut or oak wood of the best grading in exclusive quality with a velvety-soft surface and edges. The oak comes from FSC- and PEFC-certified cultivation in Germany and neighbouring countries, the walnut wood comes from sustainable forestry in American forests.

Thanks to the robust and matt lacquering of the table tops, SOMOS are a long-lasting pleasure for eyes and hands.

Legs: Powder-coated tubular steel with fine structure Pure White, fine structure Jet Black or satin gold brass

The powder coating is robust and environmentally friendly.

Foot glides: Plastic



TYPE PLAN

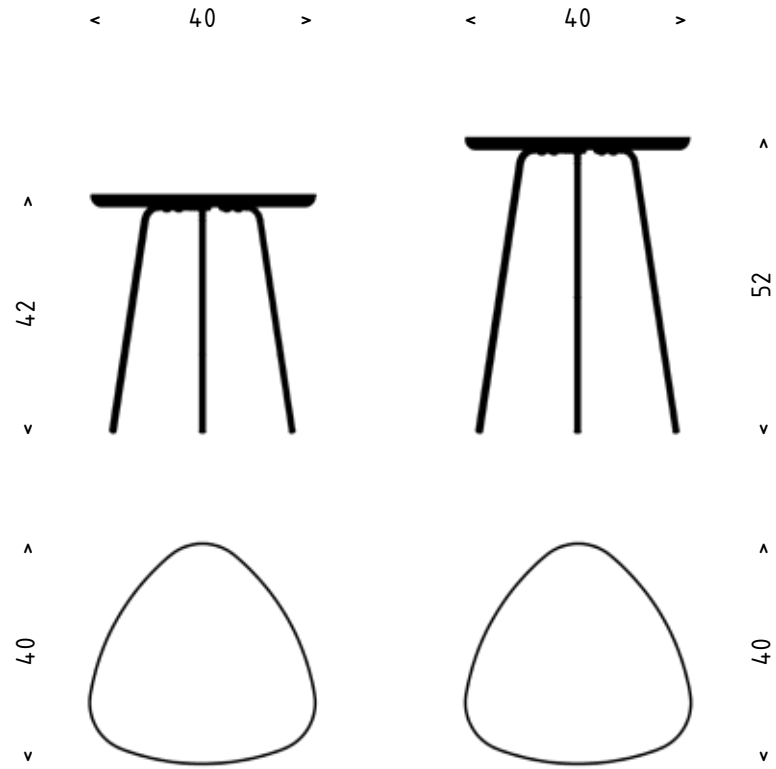

# REBAR

Foldable Shelving System



joval

# REBAR



Our REBAR foldable shelving system is a classic modern shelving system made with an innovative construction technique from a variety of solid wood slats from sustainable forestry in the Erzgebirge.

REBAR slats are made of solid walnut, oak or beech wood and are available in either a modern monochrome or classic two-tone version.

REBAR combines timeless aesthetics with function and can be used in many different ways in the living room, study, kitchen, bathroom or hallway.

REBAR can be folded flat in any size to 4-10cm and can be easily assembled and disassembled in a few easy steps. The stabilisation of the shelf results from the pressing of the solid wood slats, which are arranged in the timelessly aesthetic proportion 2:1:1 (W:D:H).

REBAR can be individually designed with coloured back panels that can be easily slid between two horizontal strips. The back boards also allow the depth of the shelf level to be adjusted.



# REBAR

The REBAR foldable shelving system was awarded the „Interior Innovation Award 2014 – Best of Best“ by the German Design Council in 2014 for its innovative construction and unique design.

interior  
innovation  
award  
2014

Best of Best



REBAR Shelf 4.0 Oak White





CHRONOS Coffee Table Pure White

REBAR Shelf 4.0 Walnut White

A close-up, low-angle photograph of a wooden shelving unit. The image shows several horizontal wooden slats of varying shades of brown, supported by vertical black metal brackets. The perspective is from below, looking up at the shelves, creating a sense of depth and structure. The lighting is soft, highlighting the natural grain of the wood.

# REBAR

## MATERIALS

Our REBAR shelves are made 100% by hand from selected solid wood slats from sustainable forestry of the best grading in exclusive quality with a velvety-soft surface and edges.

The wood is FSC- or PEFC-certified and, in the case of oak and beech, comes locally from Germany or neighbouring countries. The walnut comes from deciduous forests in North America.

## SURFACE

All solid wood slats are manufactured in a family business in the Erzgebirge and painted matt by hand. To provide durability and ease of care, the slats are painted with a robust, non-water-soluble PU varnish with a silk matt finish. Each shelf has 4 or 6 felt protectors made of high-quality grey felt with 5mm thickness and a set of replacement protectors in case of emergency.

## SLIDE-IN SHELF BACK PANELS

The slide-in back walls of our REBAR shelves are made of melamine resin-coated wood fibre boards (FSC/PEFC) in black or white and are also available in many special colours on request. One back wall of each shelf is included in the scope of delivery.



**REBAR bicoloured**

OAK / BEECH Pure White



OAK / BEECH Graphite Black



WALNUT / BEECH Pure White



WALNUT / BEECH Graphite Black

**REBAR unicoloured**

BEECH Pure White



OAK



WALNUT



BEECH Graphite Black



**joval**

# REBAR



REBAR 4.4 Walnut Graphite Black

STANDARD TYPE PLAN



Lowboard 1.0  
W 78 \ H 41

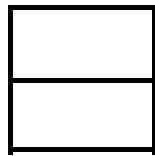

Sideboard 2.0  
W 78 \ H 78

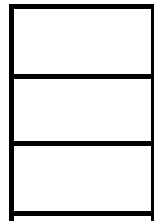

Highboard 3.0  
W 78 \ H 115

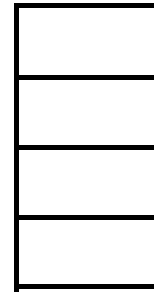

Shelf 4.0  
W 78 \ H 152

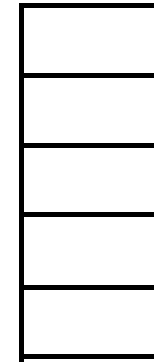

Shelf 5.0  
W 78 \ H 189

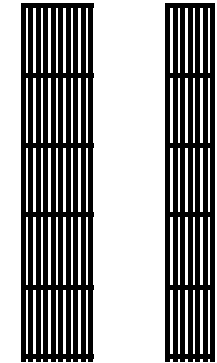

DEPTH  
38 \ 26

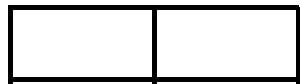

Lowboard 1.1  
W 154 \ H 41

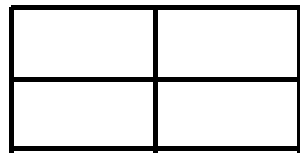

Sideboard 2.2  
W 154 \ H 78

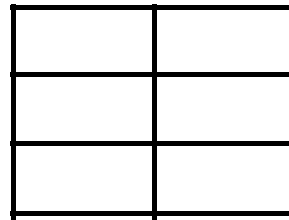

Highboard 3.3  
W 154 \ H 115

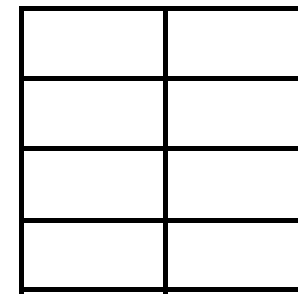

Shelf 4.4  
W 154 \ H 152

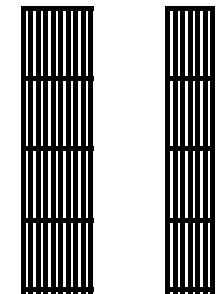

DEPTH  
38 \ 26

# HELIOS

Foldable Table Frame



# HELIOS

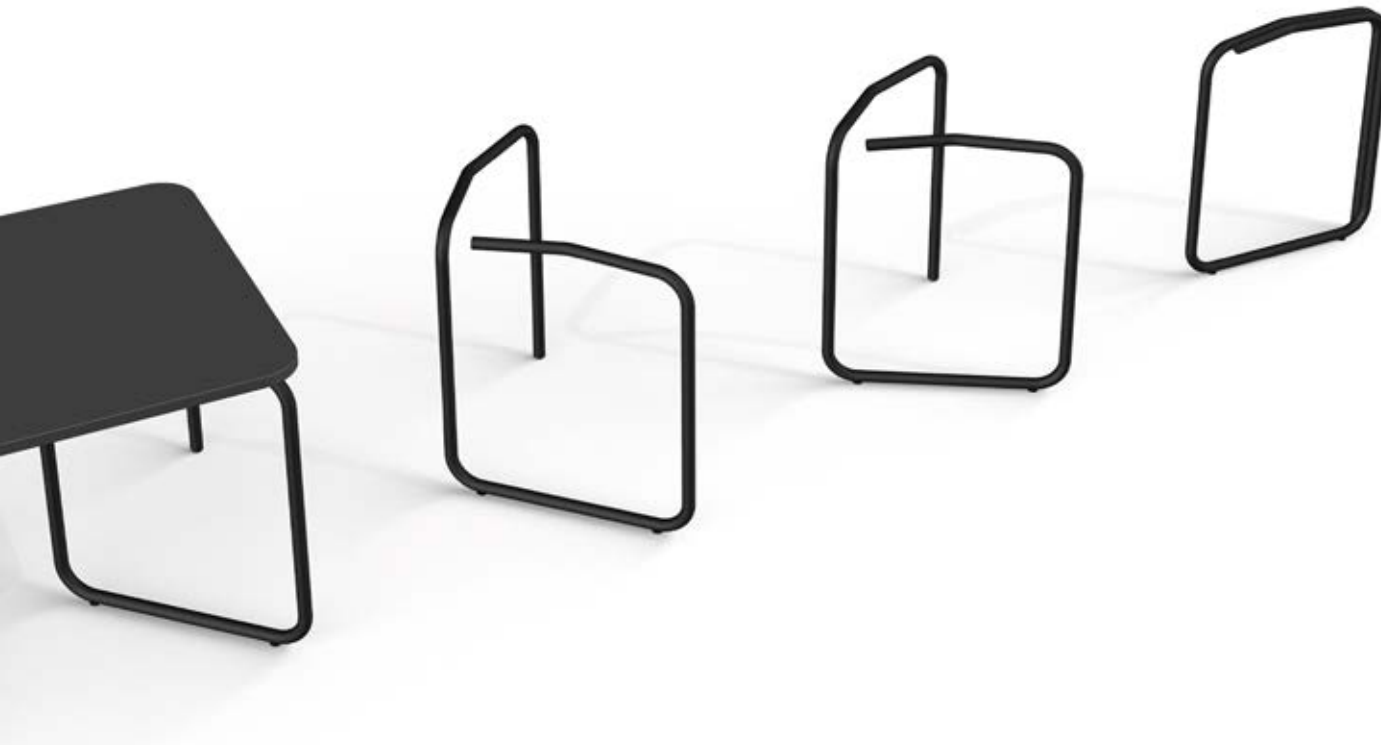

The HELIOS folding table frame is our revolutionary answer for a table frame. HELIOS can be folded vertically and thus be flexibly adapted to the width and shape of the table top.

It can be used as a V-shaped table frame in the dining table area or at a 90-degree angle for use as a desk. There are practically no limits to positioning.

Thanks to the outside legs, the table frame always offers very good legroom, regardless of whether you are sitting on the long side or the front of the table.

HELIOS is a heavy-duty table frame made of 30 mm thick tubular steel, available in a classic powder-coated version in Jet Black or Pure White and in a sophisticated version in polished chrome. The stability of the table top is additionally increased by the „third central leg“ of the HELIOS table frame. Height-adjustable feet allow to compensate for uneven floors.

HELIOS is 100% in Germany.



HELIOS was awarded the ICONIC AWARD 2016: Interior Innovation by the German Design Council.





HELIOS Chrome polished table frame in the dining table version

# HELIOS



When the HELIOS legs are positioned at a 90-degree angle under the table top, HELIOS becomes a modern, purist desk in combination with any table top.

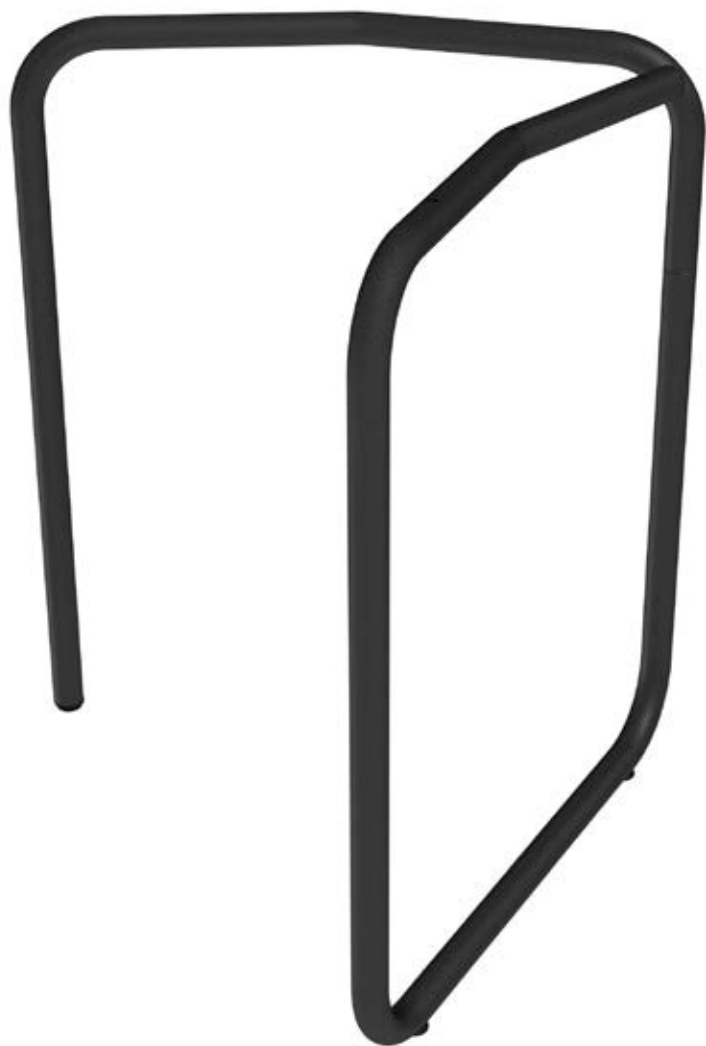

#### MEASUREMENTS

Height frame 72-73cm, width flexible

Table height: approx. 75cm

#### MATERIAL

Bent steel tube 30mm

Surface powder-coated with fine structure  
Pure White RAL 9010 / Jet Black RAL  
9005 or polished chrome

3x height-adjustable feet per frame made  
of plastic



joval

**PHILOSOPHY** joval is a young furniture brand that was founded in Munich in 2013 and is celebrating its 5th anniversary this year. Our design philosophy is to develop furniture with heart and mind that gives people long-term benefits and pleasure due to its aesthetics, quality and function. Each of our products is unique and provides a new functionality, was manufactured with a new production technique, or is characterized by its own unique design. joval furniture is sold internationally and enriches numerous apartments of private individuals and lounges of companies and hotels in cities such as Munich, Berlin, London, Paris, Moscow, or New York.

**PRODUCTION** The components of our furniture are manufactured exclusively in Germany by selected wood and metal processing companies. Our 100% quality control during the packaging process ensures that only products of perfect quality leave our warehouses. The long-standing cooperation with our suppliers allows us to respond quickly and flexibly to individual customer requests.

**SUSTAINABILITY** joval products should please hearts in the long term. We achieve the sustainability of our products on the one hand through a clear, timeless design language and on the other hand through the highest product quality.

Products that are sustainable per se and conserve valuable resources, not only at first glance, but also at second, third and fourth. The award of the „Interior Innovation Award 2014 – Best of Best“ to our shelving system REBAR is an expression of this philosophy.

In addition to our goal of „aesthetic timelessness“, we pay attention to the use of sustainable materials such as wood from sustainable forestry (PEFC/FSC-certified), environmentally friendly powder coating or stainless steel.

Our production takes place exclusively in Germany, so that transport routes are shortened. When it comes to packaging materials, we make sure that we achieve the best possible combination of product protection and recyclability of the materials used.



FOUNDER & DESIGNER  
JONAS SCHROEDER Jonas Schroeder founded the furniture brand joval as an autodidact in Munich after various experiences in Montreal, New York, Madrid, Chicago and Hamburg.

The foundation of joval results from his passion for the creation of aesthetic and functional furniture and is based on an open, unbiased attitude.

In his designs Jonas Schroeder combines analytical, mathematical approaches with precise elaboration of details and the selection of contemporary materials and colours.

One year after joval was founded, the shelving system REBAR was awarded the renowned „Interior Innovation Award 2014 - Best of Best“ by the German Design Council and in 2016 the folding table system HELIOS received the „ICONIC AWARDS 2016 - Interior Innovation“.



SHOWROOM  
NYMPHENBURGER STR. 78  
80636 MUNICH

[WWW.JOVAL.DE](http://WWW.JOVAL.DE)  
[INFO@JOVAL.DE](mailto:INFO@JOVAL.DE)  
+49-89-9545700-40

JOVAL GMBH

**joval** MADE IN GERMANY

JOVAL.DE