

baby jogger®

city tour™ 2



babyjogger.com

©2019 NWL0000880828B 1/19

ASSEMBLY INSTRUCTIONS

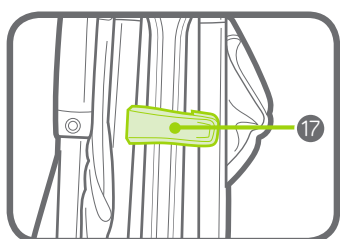
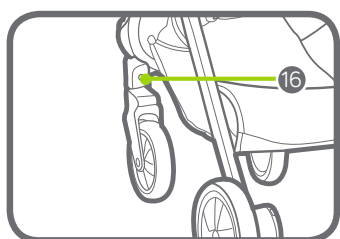
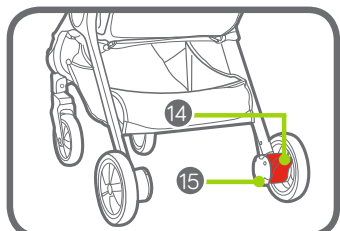
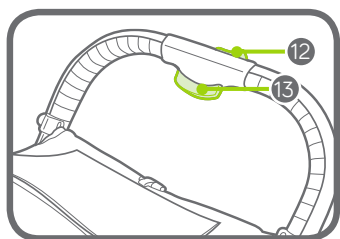
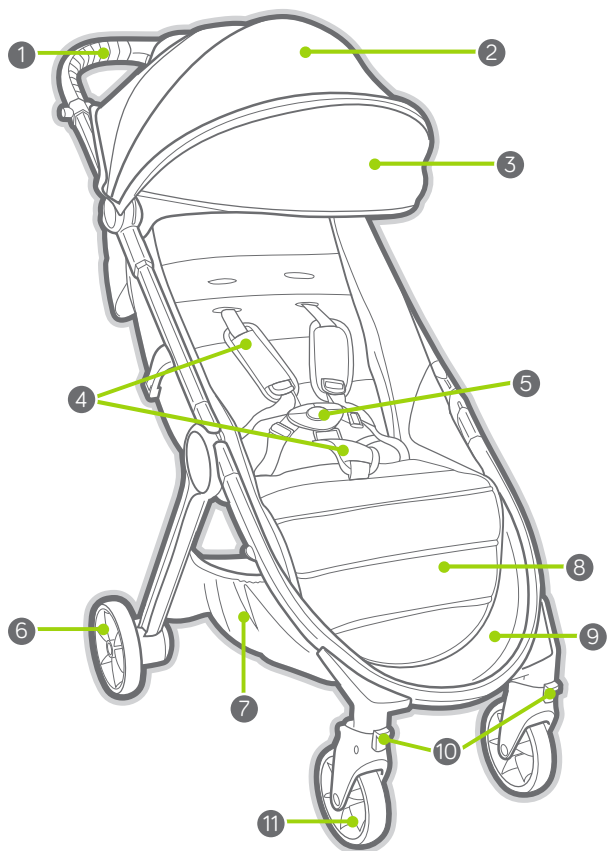

- | | | | |
|---|-----------------------------|----|-------------------------------|
| 1 | Handlebar | 10 | Swivel/Lock |
| 2 | Canopy | 11 | Front Wheel |
| 3 | Canopy Extension | 12 | Handlebar Fold Release Button |
| 4 | Harness Pads and Buckle Pad | 13 | Handlebar Fold Button |
| 5 | Harness Buckle | 14 | Parking Brake |
| 6 | Rear Wheel | 15 | Rear Wheel Release Button |
| 7 | Storage Basket | 16 | Front Wheel Release Button |
| 8 | Leg Support | 17 | Auto-lock |
| 9 | Footwell | | |

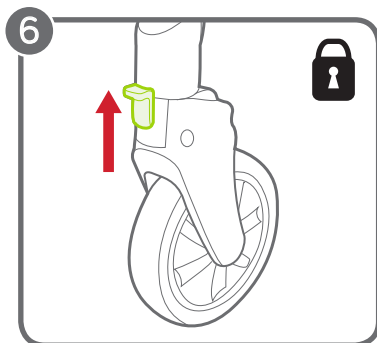
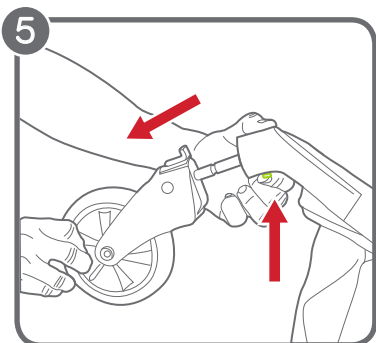
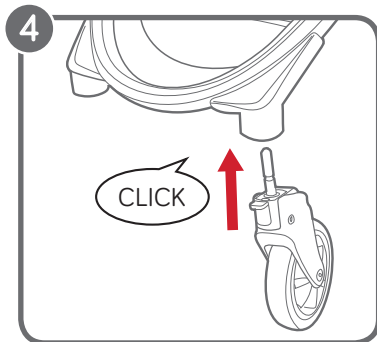
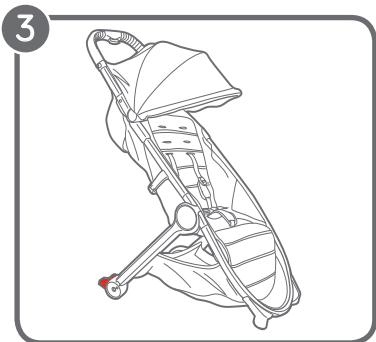
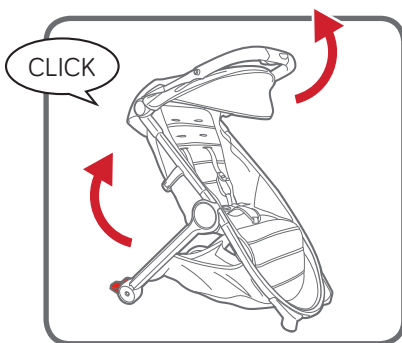
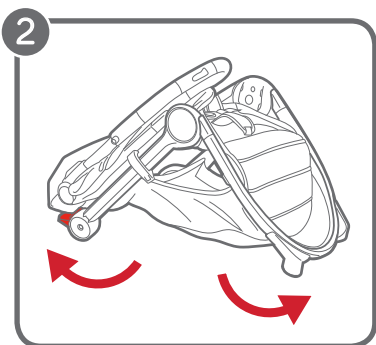
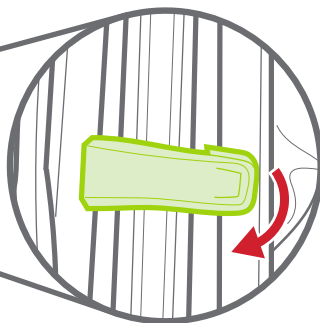
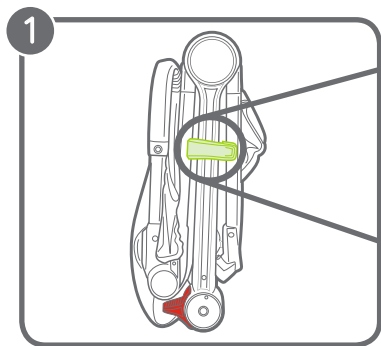

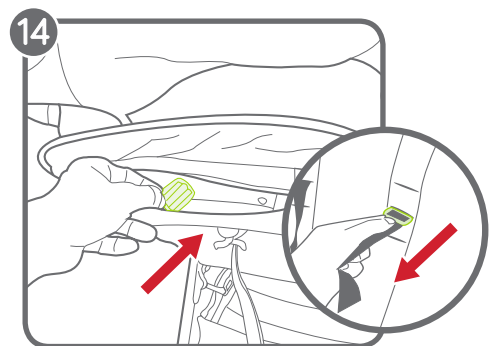
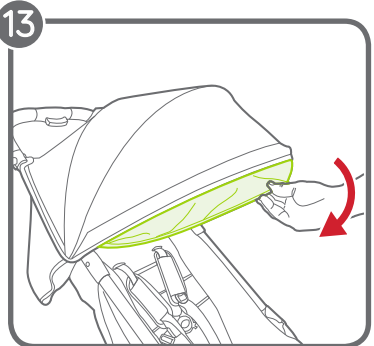
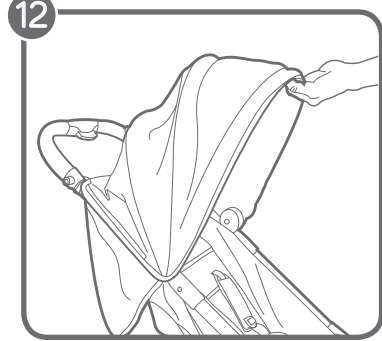
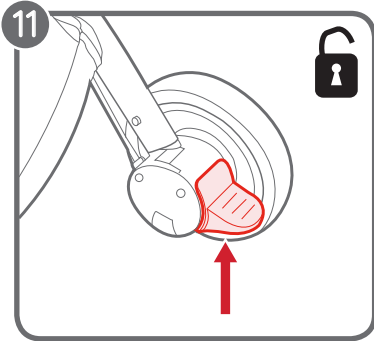
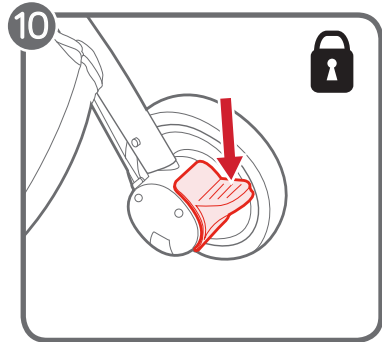
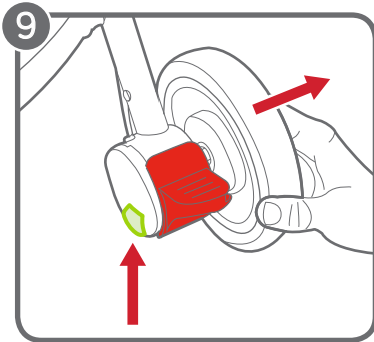
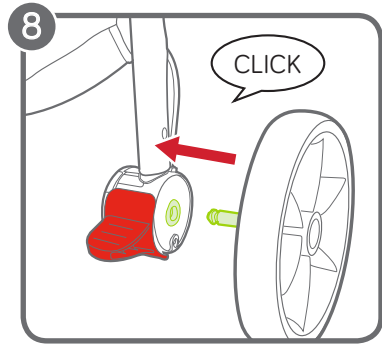
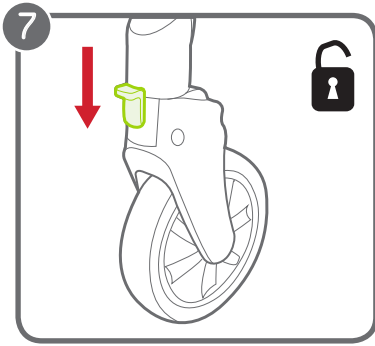

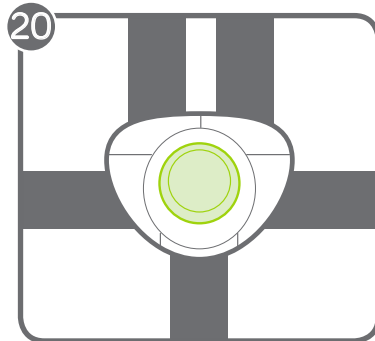
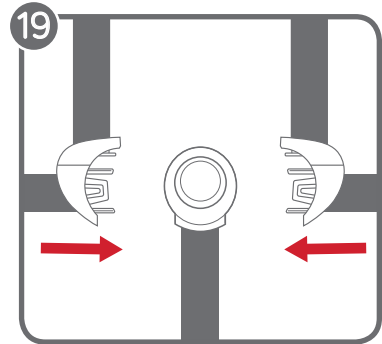
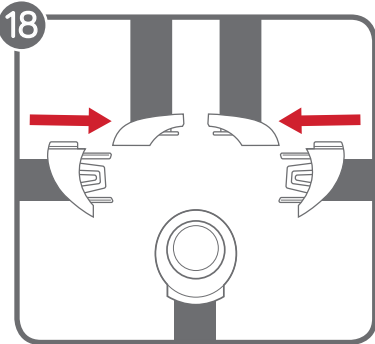
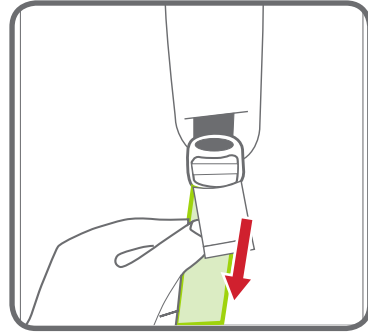
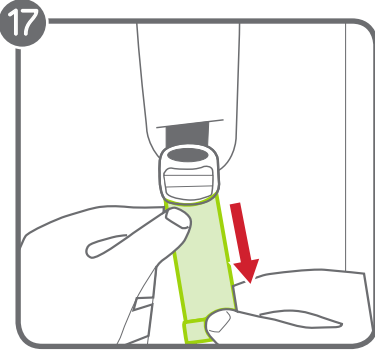
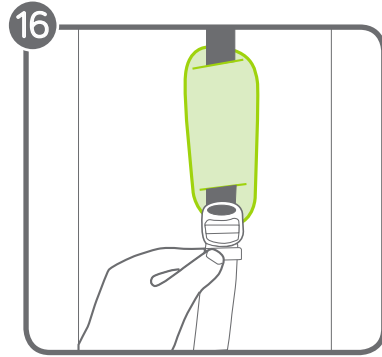
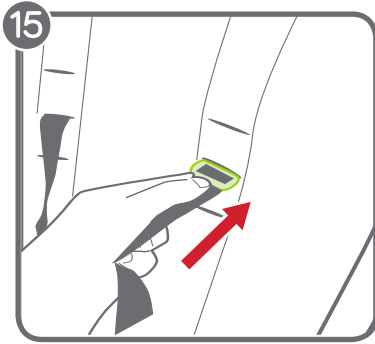

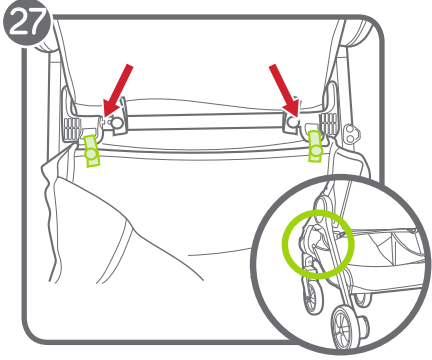
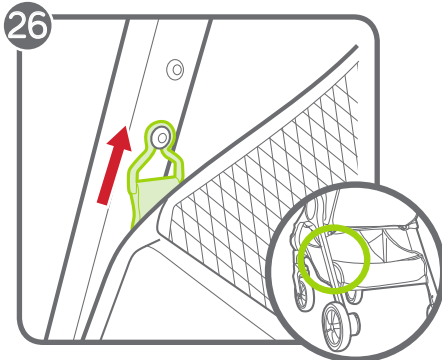
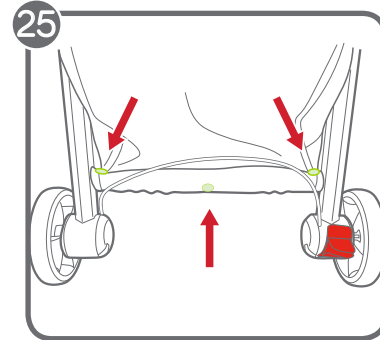
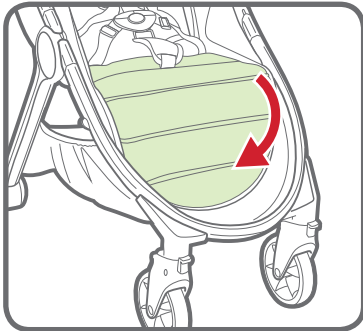
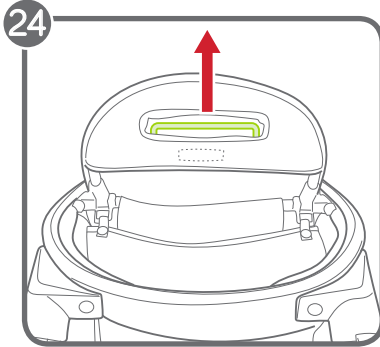
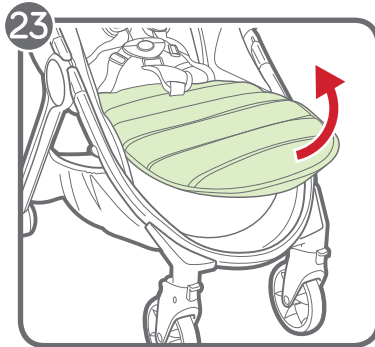
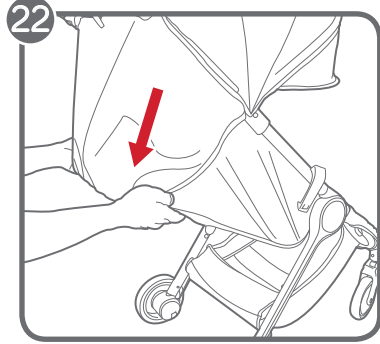
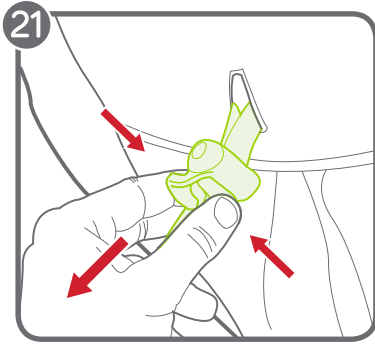

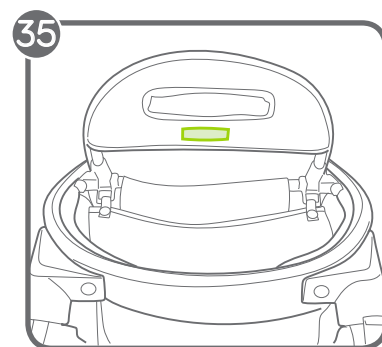
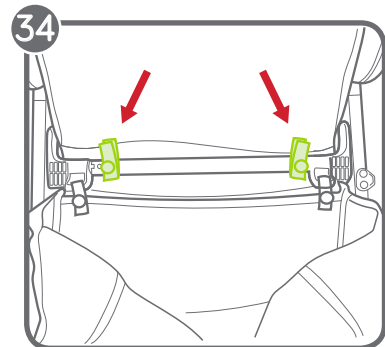
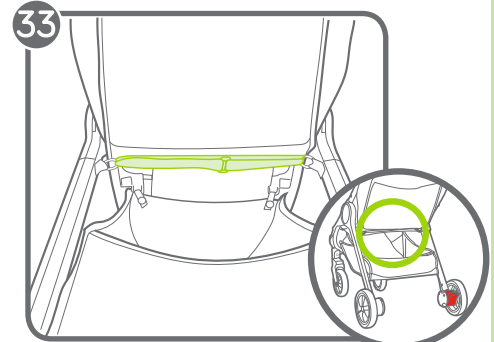
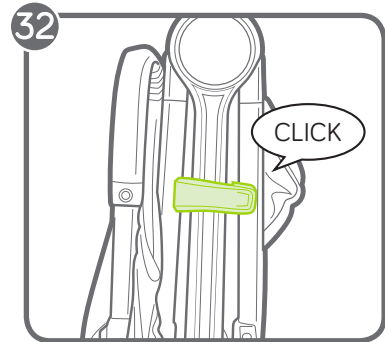
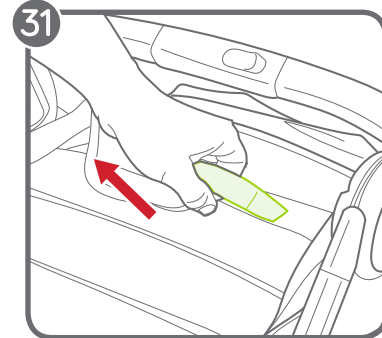
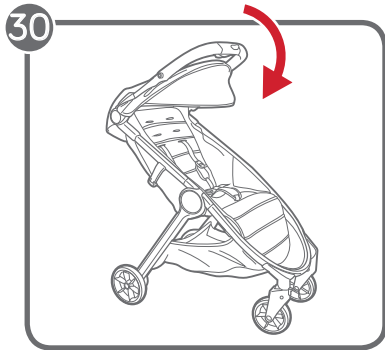
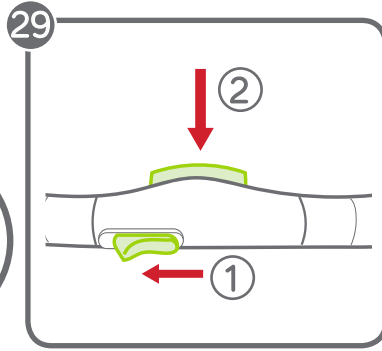
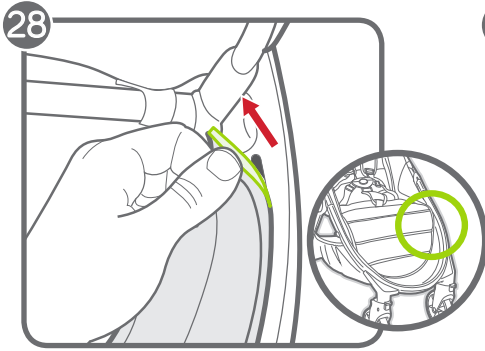

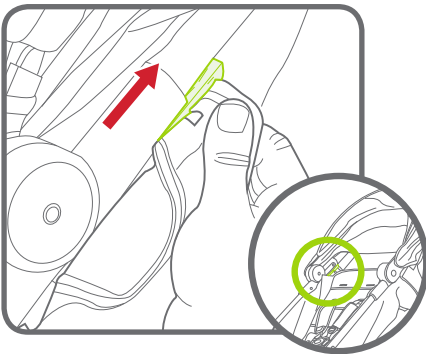
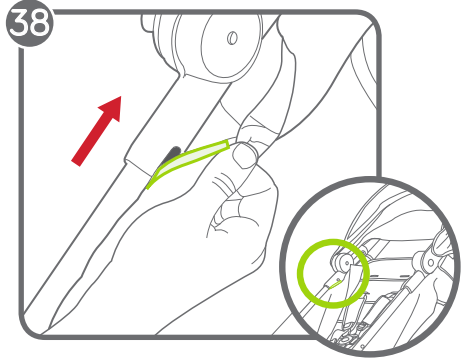
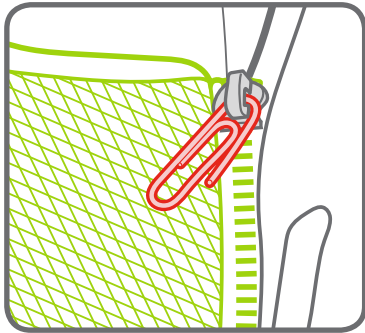
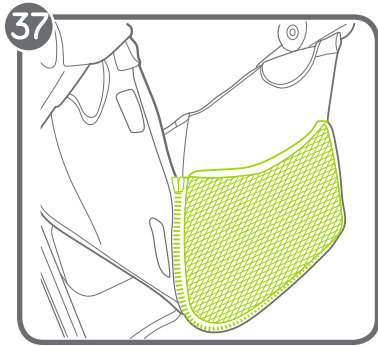
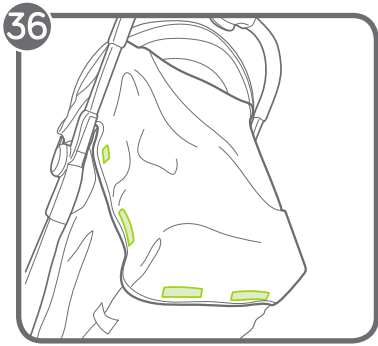

WARNING

IMPORTANT - Keep these instructions for future reference. Read these instructions carefully before use. Your child's safety may be affected if you do not follow these instructions.

SINGLE STROLLER

- This stroller seats one passenger. Never allow more than one child at a time on this stroller.
- Maximum weight is 205 kg (45 lb); maximum height is 1016 cm (40 in).
- Total weight load recommended for this stroller is 27 kg (60 lb), 205 kg (45 lb) in the seat and 7 kg (15 lb) in the basket. Excessive weight may cause a hazardous unstable condition to exist.
- This stroller is not suitable for running, jogging, skating or rollerblading.
- Always use the restraint system.
- Check that the pram body or seat unit attachment or car seat attachment devices are correctly engaged before use.
- To avoid injury, ensure that your child is kept away when unfolding and folding this product.
- Do not let your child play with this product.
- Parcels or accessory items, or both, placed on the unit may cause the unit to become unstable.
- Ensure that all the locking devices are engaged before use.
- When loading and unloading child, lock the front wheel in a fixed position.
- Any load attached to the handle and/ or on the sides of the stroller affects the stability and folding mechanism of the stroller.
- Stroller is not meant to be used for transporting children up or down stairs, travelators, or escalators. Damage resulting to stroller will not be covered under warranty.
- This stroller does not replace a cot or a bed. Should your child need to sleep, then it should be placed in a suitable pram body, cot, or bed.
- Accessories which are not approved by the manufacturer or distributor shall not be used.
- Watch out for cars - never assume that a driver can see you and your child.
- The passenger shall remain seated (no standing in the stroller).

- It may be unsafe to use replacement parts other than those supplied or approved by Baby Jogger.
- **TO AVOID INJURY OR DEATH:**
- **ALWAYS APPLY THE BRAKES WHENEVER THE STROLLER IS STATIONARY.**
- **DO NOT LEAVE CHILDREN UNATTENDED.**
- **SECURE THE CHILD IN THE HARNESS AT ALL TIMES.**
- **DO NOT CARRY EXTRA CHILDREN OR BAGS ON THIS STROLLER.**
- **MAKE SURE CHILDREN ARE CLEAR OF ANY MOVING PARTS IF YOU ADJUST THE STROLLER.**
WARNING: USE THE HARNESS AT ALL TIMES.
WARNING: USE THE STRAP TO STOP THE STROLLER ROLLING AWAY.
WARNING: NEVER LEAVE THE HARNESS BUCKLED WHEN NOT FITTED TO A CHILD. THE HARNESS CAN FORM LOOPS THAT POSE A STRANGULATION HAZARD TO THE CHILD.
- Lock the brakes before loading and unloading your child and whenever the stroller is not moving.
- Avoid serious injury from falling or sliding out. Always properly adjust and fasten safety harness.
- Check that the pram body or seat unit or car seat attachment devices are correctly engaged before use.
- This seat should be used in the most reclined position until a child can sit up unaided, roll over, or push itself up on its hands and knees.
- Be aware of the risk of open fire and other sources of strong heat, such as electric bar fires, gas fires, heaters, etc., in the near vicinity of the stroller.
- This stroller is designed for use on flat or gently sloping surfaces. Be aware that the possibility for tipping occurs if this product is used on higher sloping and uneven surfaces.
- Always keep fingers away from moving parts when folding, unfolding, or adjusting the stroller to prevent finger/body part entrapment or pinching.
- Before lifting and carrying the stroller, make sure the storage lock is properly secured.

FRAME

- 1 Unpack the stroller frame from the box and set the wheels aside. Unlock the stroller by pulling the auto-lock lever.
- 2 Pull the lower front frame of the stroller away from the rear legs. Then, lift the seat back frame upwards from the rear legs. Lastly, unfold the handlebar upwards. The stroller will lock into position and you will hear a click.
- 3 Place the stroller in the upright position.

 **WARNING:** Ensure that all the locking devices are engaged before use.

FRONT WHEEL

- 4 Installation
 - Attach the front wheel by sliding it into the front wheel mount until it clicks. Gently pull on the front wheel to make sure it is properly attached.
- 5 Removal
 - While pressing the front wheel release button, gently slide the front wheel out of the front wheel mount.

SWIVEL FEATURE

- 6 Push the swivel lock button up to lock the front wheel to a fixed position.
- 7 Press the swivel lock button down to allow the front wheel assembly to swivel.

 **WARNING:** When loading and unloading child, lock the front wheel in a fixed position. Although the front wheel of your stroller locks, it is not intended for jogging or exercise purposes.

REAR WHEELS

- 8 Installation
 - Align the rear wheel axle with the wheel mount on the stroller frame and insert it into the wheel mount until it locks into place. You will hear a click.
 - Gently pull on the rear wheel to make sure it is properly attached.
- 9 Removal
 - While pressing down on the wheel release button, gently slide the rear wheel out of the wheel mount.

BRAKE

- 10 To lock the brakes: push the brake lever down to engage the brakes.
- 11 To release the brakes: lift the brake lever up.

 **WARNING:** Lock the brakes before loading and unloading your child and whenever the stroller is not moving.

CANOPY

- 12 Pull forward to open canopy, push backwards to close canopy.
- 13 To use the canopy extension: Pull the extension out from under the canopy until it snaps into place, push the extension under the main canopy to hide.

ADJUSTING THE SHOULDER STRAPS

- 14 From the back of the seat, undo the fastening strip and open the pocket to locate the plastic square stopper. Turn stopper and pass through the openings in the plastic board and seat fabric.
- 15 Reinsert stopper at seat opening closest to child's shoulders. Pass back through seat fabric and plastic board. Tug on strap to ensure stopper is locked. Repeat on both sides.

 **WARNING:** Avoid serious injury from falling or sliding out. Always properly adjust and fasten safety harness.

⚠ WARNING: Always use the crotch strap in combination with the shoulder straps and waist belt.

16 Slide the harness pads up to access plastic guide on strap.

17 Hold the plastic guide and pull strap to tighten or loosen.

USING SAFETY HARNESS

18 Insert side strap buckle into harness buckle on both sides.

19 Insert connected harness and side strap buckles into the sides of the crotch buckle.

20 Press button on crotch buckle to release.

RECLINE THE BACKREST

21 Pinch the clamp behind the backrest, and slide it down to desired position.

22 Pull backrest down on both sides to match the clamp position. Reverse steps to return to the upright position.

⚠ WARNING: When making adjustments to the stroller seat, make sure child's head, arms, and legs are clear of moving seat parts and stroller frame.

LEG SUPPORT INCLINE

23 Lift the leg support up in order to raise it.

24 To lower the leg support, pull the release bar underneath it and push it down.

BASKET REMOVAL

25 From underneath the stroller, unfasten the snaps of the basket near the rear of the stroller.

26 At the rear of the stroller, push up on the hanging clips to remove them from the stroller frame.

27 From under the front of the stroller, unfasten and unloop the two snaps.

28 Pull the basket fabric out of the channels in the footwell.

FOLDING

- Remove your child from the seat.
- Remove all attachments and all items from basket.

29 Slide the handlebar fold release button and hold it, then squeeze the fold button on the handle bar and fold the handlebar forward.

30 Fold the upper stroller frame down to the lower stroller frame.

31 Pull up on the strap on the seat and let the frame collapse.

32 Make sure the auto-lock lever clicks into place.

REMOVING THE SEAT FABRIC

33 From the underside of the seat, unfasten the hook-and-loop and slide the strap through the D-ring.

34 Unfasten and unloop the two snaps underneath the seat.

35 Undo the fastening strip underneath the leg support.

36 Undo the six fastening strips on the back of the seat.

37 To remove the head barrier: Insert a paper clip into the hole on the zipper slide. Using the paper clip as the zipper pull, unzip the head barrier from the seat.

38 At the top of the seat, pull the seat fabric out of the channels in the frame.

⚠ WARNING: Make sure that all fasteners are properly closed when re-attaching the seat fabric.

CARE AND MAINTENANCE

To preserve the longevity of your stroller, it is important to perform simple, regular maintenance. From time to time, make sure that the joints and folding areas are still in good condition. If you hear any squeaking or feel tension, you can take your stroller to a local bike shop for added lubrication. All repairs should only be carried out by an authorized dealer.

WASHING

Seat Fabric

- DO NOT machine wash fabrics.
- The seat and canopies of our strollers and joggers are made from strong, lightweight, washable fabrics which easily detach from the frame. We recommend to hand wash your fabrics using cold water and a mild detergent. Place fabrics back on the frame and leave outside to air dry. A hot/sunny day is the perfect time to clean your stroller as fabrics will dry quicker.
- If the seat covers need to be replaced, only use parts from a Baby Jogger Authorized Dealer. They are the only ones that are guaranteed to have been safety tested and designed to fit this seat.

Plastic/Metal Parts

- Wipe clean using a mild soap and warm water.
- You must not remove, dismantle or alter any part of the seat folding mechanism or brakes.

Wheel Care

- The wheels can be cleaned using a damp cloth. They will need to be dried completely with a soft towel or cloth.

STORING

- Sunshine can fade seat fabric and dry out tires, so storing your stroller indoors will prolong its good looks.
- DO NOT store outside.
- Ensure that the stroller is dry before storing for prolonged periods.
- Always store the stroller in a dry environment.
- Store the stroller in a safe place when not in use (i.e. where children cannot play with it).
- DO NOT place heavy objects on top of the stroller.
- DO NOT store the stroller near a direct heat source such as a radiator or fire.

Baby Jogger's Limited Lifetime Warranty

Baby Jogger warrants that the frame is free of manufacturer defects for the lifetime of the product. Manufacturer's defects include but are not limited to the breaking of welds and frame tube damage. Textile or soft side materials and all other components shall be warranted for one year from the date of purchase (except for tubes and tires). Proof of purchase is required to make a warranty claim and the warranty is only extended to the original purchaser.

Your stroller comes with a limited lifetime warranty on the frame and a 12 month warranty on textiles and mechanical components. Visit www.babyjoggerstrollers.com.au to register your new stroller and we'll extend your warranty by a further 12 months.

THIS WARRANTY DOES NOT COVER:

- Normal wear and tear
- Corrosion or rust
- Incorrect assembly, or the installation of third party parts or accessories not compatible with the original design
- Accidental or intentional damage, abuse or neglect, or use on stairs, travelators or escalators.
- Commercial use
- Improper storage/care of the unit

This warranty specifically excludes claims for indirect, incidental, or consequential damages. The implied warranties of merchantability and fitness for a particular purpose is according to the specific warranty period for this model unit at time of purchase. Some states do not allow the exclusion or limitation of incidental or consequential damages, so the above limitations or exclusions may not apply to you. This warranty gives you specific legal rights, and you may also have other rights which vary from state to state. To know what your legal rights are in your state, consult your local or state consumer affairs office or your State's Attorney General.

The benefits given to you by our warranty are in addition to other rights and remedies under law in relation to the product. Our goods come with guarantees that cannot be excluded under the Australian Consumer Law. Our goods also come with guarantees that cannot be excluded under the New Zealand Consumer Guarantees Act. You are entitled to a replacement or refund for a major failure and compensation for any other reasonably foreseeable loss or damage. You are also entitled to have the goods repaired or replaced if the goods fail to be of acceptable quality and the failure does not amount to a major failure.

If your stroller was purchased outside of the United States, please contact the distributor in the country nearest you. Their contact information can be found on our website at <http://www.babyjogger.com/retailers/#international>. Claims for warranty outside of the country in which the product was purchased may incur shipping charges.

NOTE: When contacting Baby Jogger distributor regarding your stroller, please have your stroller's model number and manufacturing date ready. It can be found on the inside of the rear leg.



IN AUSTRALIA CONTACT:

Call: 1300.661.885
03.8872.6772
Fax: 03.9873.1433
Mail: The Amazing Baby Company
7-9 Maurice Court
Nunawading, Victoria 3131
Australia

IN NEW ZEALAND CONTACT:

Call: (64) 03.338.7613
Fax: (64) 03.338.7615
Mail: Baby First Limited
25 Nga Mahi Road
Sockburn
Christchurch, 8024
New Zealand

NOTES:

NOTES:



Baby Jogger, LLC

A BRAND newell Company

6655 Peachtree-Dunwoody Rd. NE, Atlanta, GA 30328
1.800.241.1848 • www.babyjogger.com

Distributed in Australia By:

The Amazing Baby Company

7-9 Maurice Court • Nunawading VIC 3131 • Australia

T: 1300.661.885 • 03.8872.6772 • F: 03.9873.1433

www.theamazingbabycompany.com.au

Distributed in New Zealand By:

Baby First Limited

25 Nga Mahi Road • Sockburn Christchurch, 8042 • New Zealand

T: (64) 03.338.7613 • F: (64) 03 338 7615

www.babyfirst.co.nz