

Acaia Coffee Scale Operation Manual

Using Your Acaia Coffee Scale

acaia

FW 2.0.01

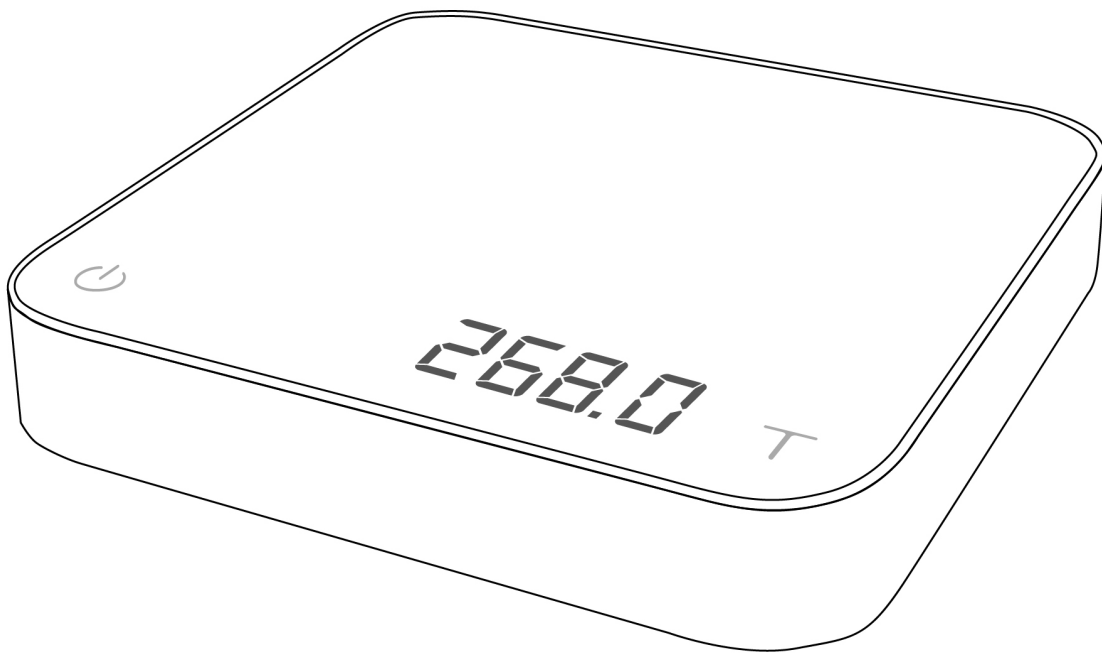

Identification

The instructions in this operation manual apply to Acaia Coffee Scale. You have purchased a quality precision weighing scale that requires handling with care. Make sure to read through this operation manual prior to using the scale.

Disclaimer Notice

Calibrate your scale using calibration weight of the appropriate tolerance (class). A scale can be no more accurate than standard masses to which it has been compared. For more details, please read Calibration Mode section in the operation manual.

CAUTION:

- 1. Do not place any hot object directly on the weighing pan. Please use a heat resistant pad under hot objects.**
- 2. Any modification made without the consent of manufacturer may result in damage to scale.**

Contents

4 Chapter 1: Scale at a Glance

- 4 Introduction
- 4 Specification
- 5 Scale overview
- 6 Accessories
- 6 Buttons
- 7 LED indicators
- 7 Battery charge

8 Chapter 2: Getting Started

- 8 Preparation
- 9 Installation

10 Chapter 3: Basics

- 10 An overview of operation structure
- 11 Basic operations
- 12 Weighing mode
- 12 Timer-weighing mode
- 13 autostart timer mode
- 14 beverage weight mode

15 Chapter 4: Calibration

- 15 Calibration mode
- 15 Creep compensation mode

16 Chapter 5: Configuration

- 16 Setup mode
- 17 Setup mode settings
- 18 Auto sleep settings
- 18 Auto zero settings
- 18 Zero tracking
- 18 Key sound settings
- 19 Zero range settings
- 19 Weighing filter settings
- 19 Default weighing unit settings
- 20 Weighing resolution

21 Appendix

- 21 Error code

Chapter 1: Scale at a Glance

Introduction

Thank you for choosing one of our scales. The Acaia Coffee Scale is designed and manufactured to the most rigorous standard to give you the best coffee brewing experience. First of all, check the shipping carton to find the followings:

• Acaia Coffee Scale • AC Adapter • Micro-B USB cable

Next, follow the instructions in Preparation and Installation sections in the manual to get started.

To take an advantage of its many features, carefully read through the operation manual containing step-by-step procedures, examples, and other information.

Warning: Incorrect handling of this product could possibly result in personal injury or physical damage.

Specifications

Aprox. weight	462g		
Capacity	2000g / 70.54oz		
Measuring Units	g , oz		
Weighing range 1	Maximum capacity	1000.0g	35.280oz
	Minimum capacity	1.0g	0.035oz
	Division	0.1g	0.005oz
Weighing range 2	Maximum capacity	2000.0g	70.540oz
	Minimum capacity	1000.0g	35.280oz
	Division	0.5g	0.020oz
Indication limit	2060.0g / 72.660oz		
Unit dimensions	(L x W x H) 160x160x30mm		
Electrical Requirements	5V/500mA		
Power and Battery	Lithium-ion rechargeable 3.7V 1100mA		
Display	LEDTop: PC, Touch sensitive		
Bottom	anti-slip, rubber, flat surface.		
Connectivity	Bluetooth 4.0		
Linearity	+/- 0.2g		
Work time	Up to 25 hours		

Scale Overview

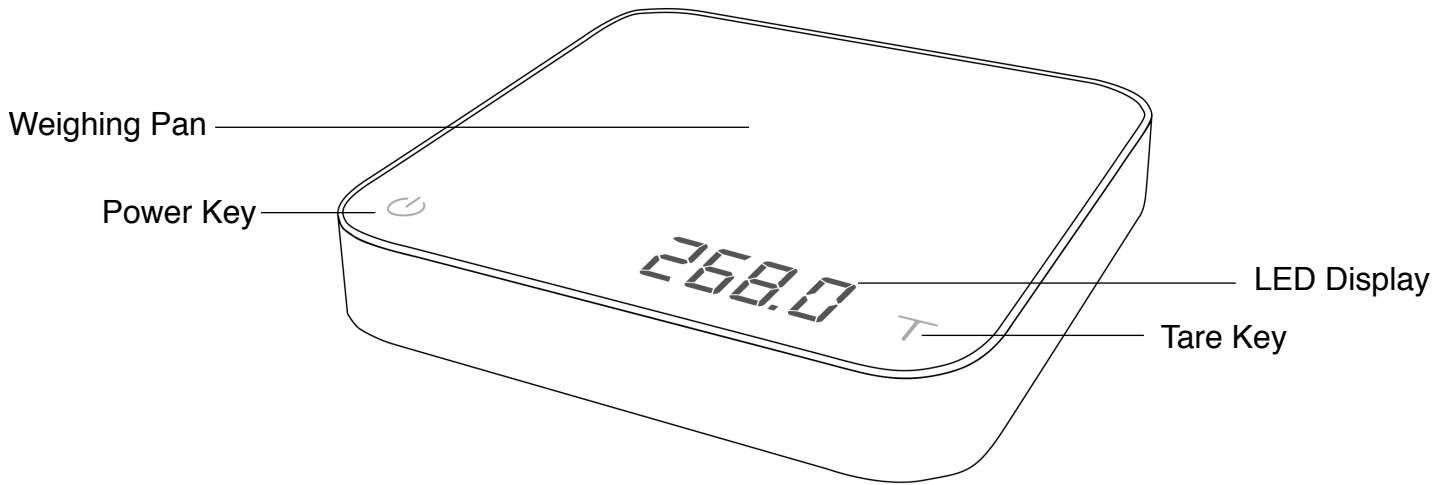

Scale Front

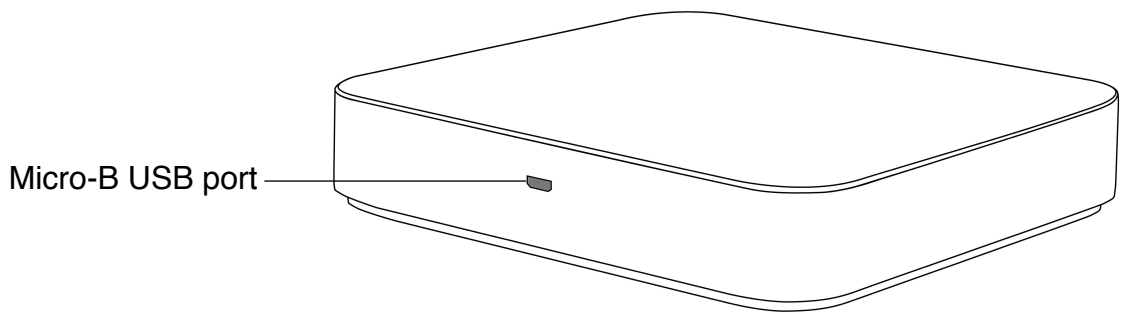

Scale Back

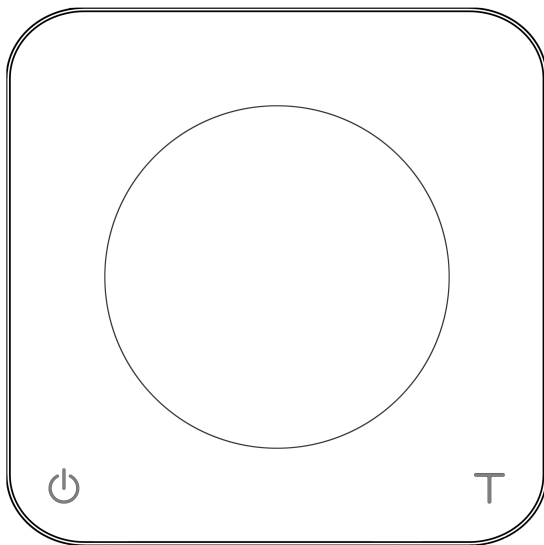

*Note: For the best performance, place the weight in center of weighing platform.

Accessories

Micro-B USB Cable

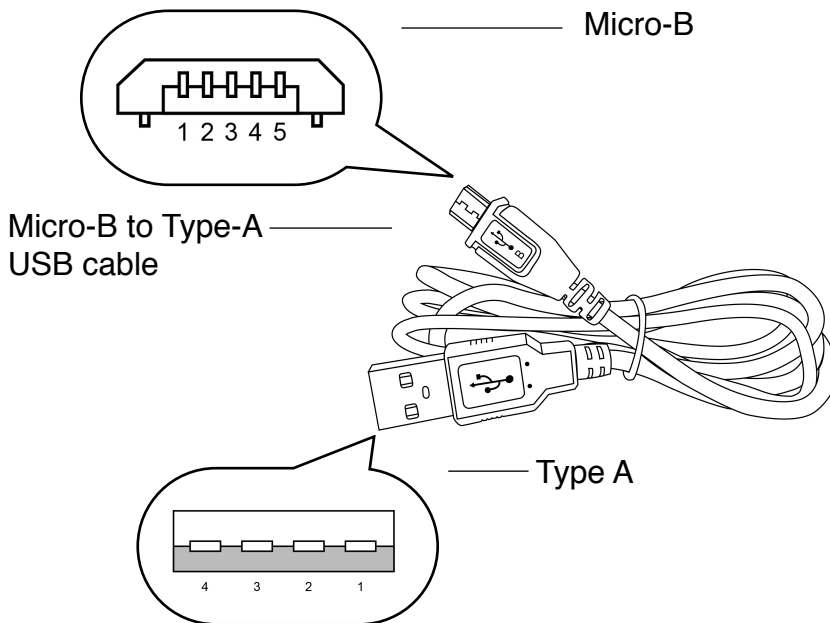

AC Adapter

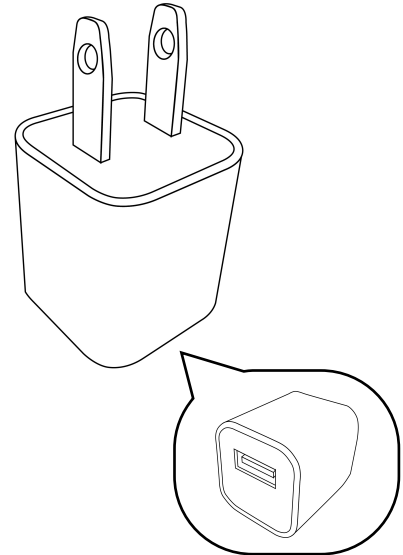

Buttons

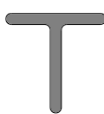
Button	Function	Example
	Turn on	Press and hold for 0.5 seconds to turn on the scale.
	Turn off	Double-tap the power button to turn off the scale.
	Switch mode	While the scale is turned on, press and hold for 2 seconds to switch mode: Weighing Mode / Timer-Weighing Mode / Autostart Timer Mode.
	Start / pause timer	While in Timer Mode, press to start or pause timer.
	Back	While in Setup Mode, press to go back to Weighing Mode from menu tree.
	Tare	While in Weighing Mode, press to make tare operation.
	Reset timer	While in Timer Mode, press and hold to reset timer.
	Switch option	While in Setup Mode, press to switch options.
	Confirm	While in Setup Mode, press and hold for 2 seconds to confirm the option selected.
	Enter calibration modes	<ol style="list-style-type: none"> 1. While in Weighing Mode, continuously press multiple times to enter Calibration Mode. 2. While in Calibration Mode, continuously press multiple times to enter Creep Compensation Mode.

* Please find **Chapter 3: Basics** for more details.

LED Indicators

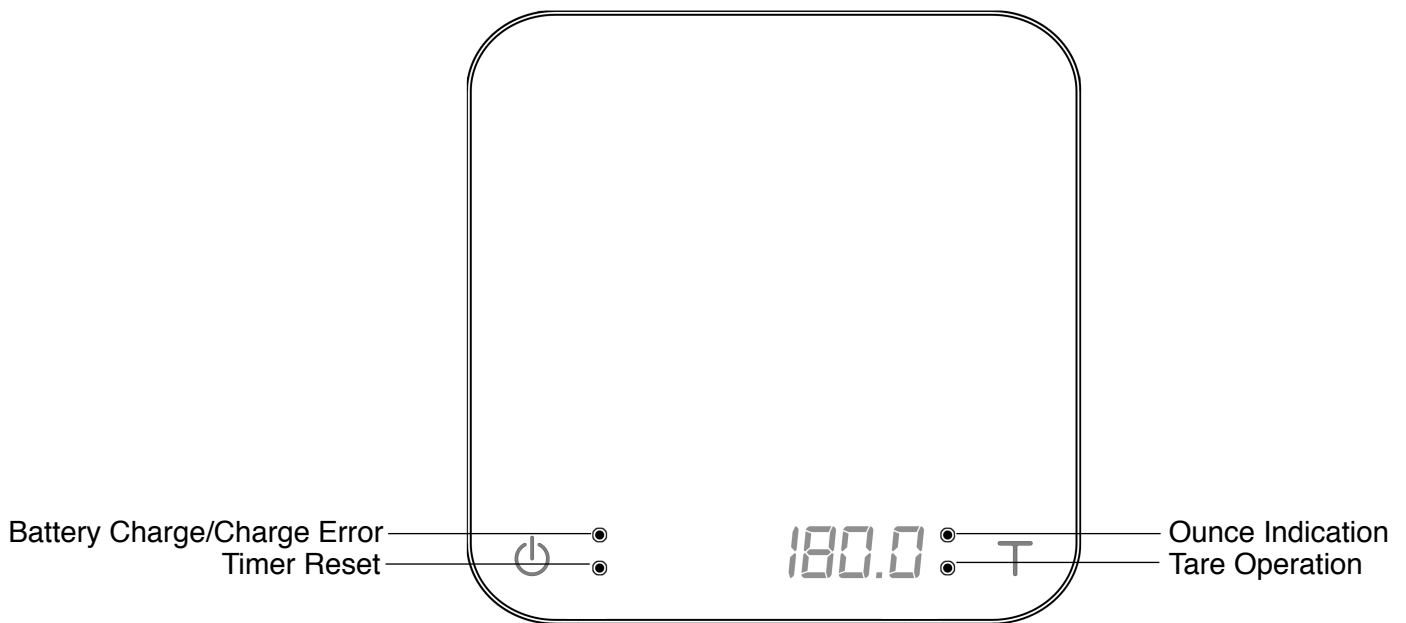

Battery Charge / Charge Error

The LED indicator on the upper left lights on in orange when the battery is charging and lights off when the battery is fully charged. The indicator starts flashing when the USB cable is not working.

Timer Reset

The timer displays from 0 to 59 seconds in cycle and will reset when reaching 60 seconds. The LED indicator on the lower left lights on in orange when the timer resets.

Tare Operation

The tare indicator on the lower right lights on once in green when T button is pressed.

Ounce Indication

The ounce indicator on the upper right lights on in green when the weighing unit is in ounce.

Battery Charge

- You can charge the battery by plugging the USB cable to any power supply listed below:
 - A computer
 - A wall A/C via USB power adaptor
 - A DC via car power adaptor
- It takes about 1~2 hours to fully charge the battery from empty. You can charge the battery more frequently so that it will never hit empty.
- A fully charged battery can continuously last for about 25 hours.
- Battery percentage can be viewed via Acaia APP.

Chapter 2: Getting Started

Preparation

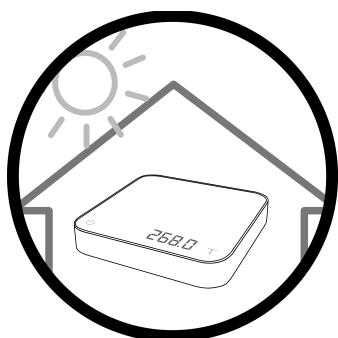

- This scale is intended for indoor use.



- Select a work place that is stable, vibration-free and, if possible, a horizontal location for the weighing platform.



- Do not locate the scale near any equipment/instrument which contains magnets.

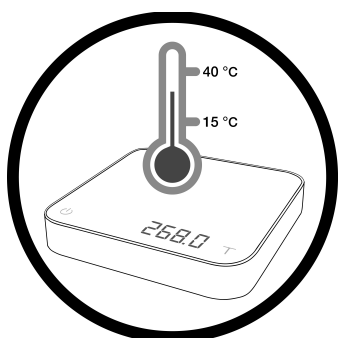

- Avoid places where room temperatures are unstable. Room temperature above 40°C or below 15°C may result in weighing inaccuracy.

Installation

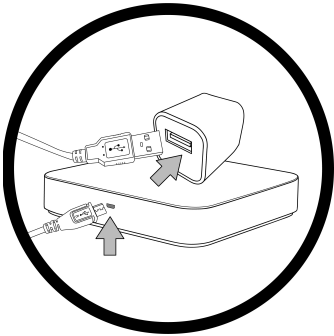

- To use AC adapter instead of the built-in battery, plug the USB cable into the Micro-B USB port located on the back panel of the scale.



- Press  button for 0.5 seconds to turn on the scale.
- * **It is highly recommended to calibrate the scale with calibration weight before using.**



- Please make sure to use a heat resistant pad under hot objects.

Chapter 3: Basics

An Overview of Operation Structure

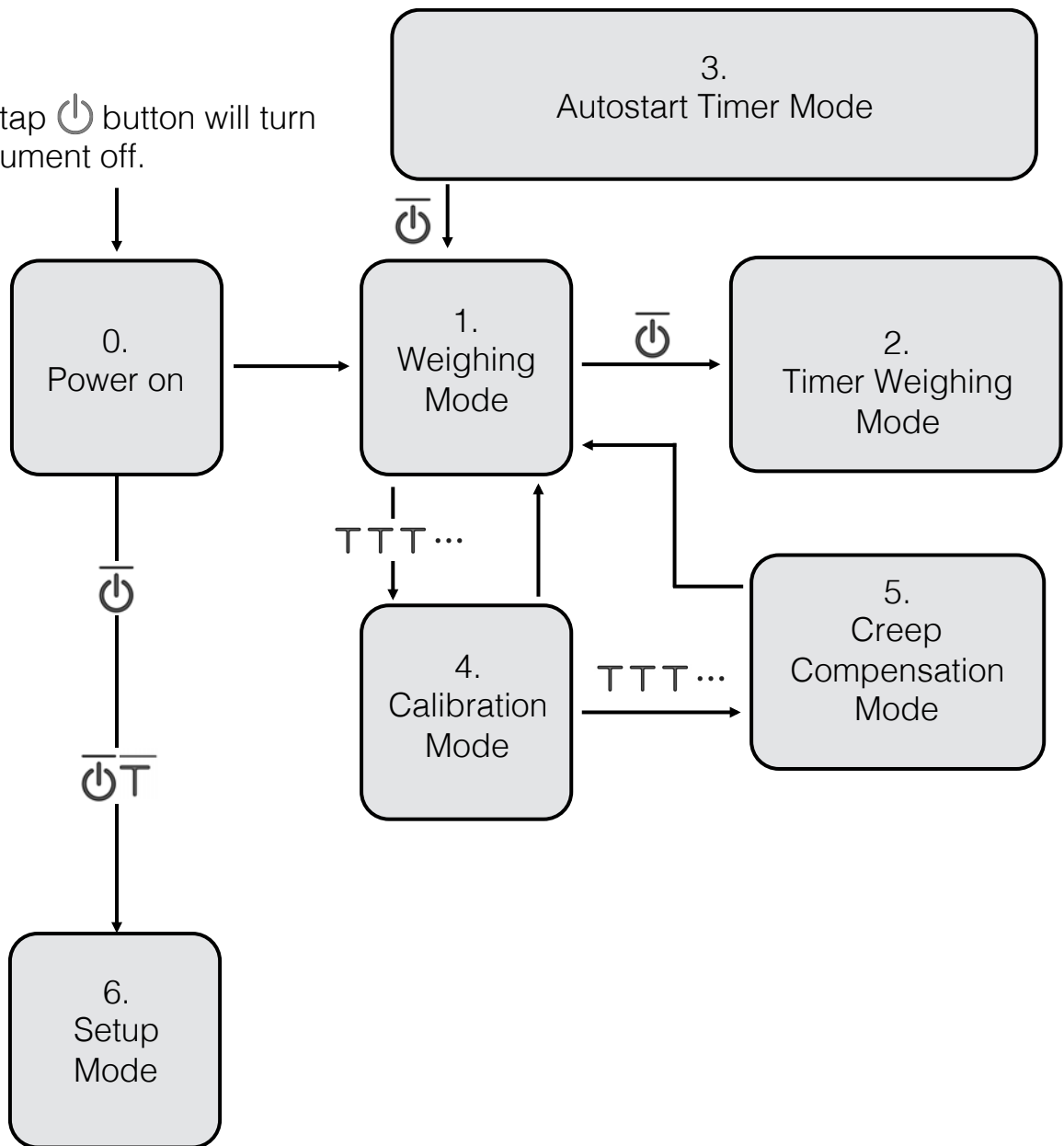

Double-tap  button will turn the instrument off.



Key operations:

TTTT... Click T key for several times.

 Press and hold  key for about 2 seconds.

 Press and hold both  key and  key for about 2 seconds.

Basic Operations

Turn On

Press and hold  button for 0.5 seconds to turn on the scale.

Turn Off

Double-tap  button to turn off the scale.

Switch Modes

Press and hold  button for 2 seconds each time to toggle through different modes.

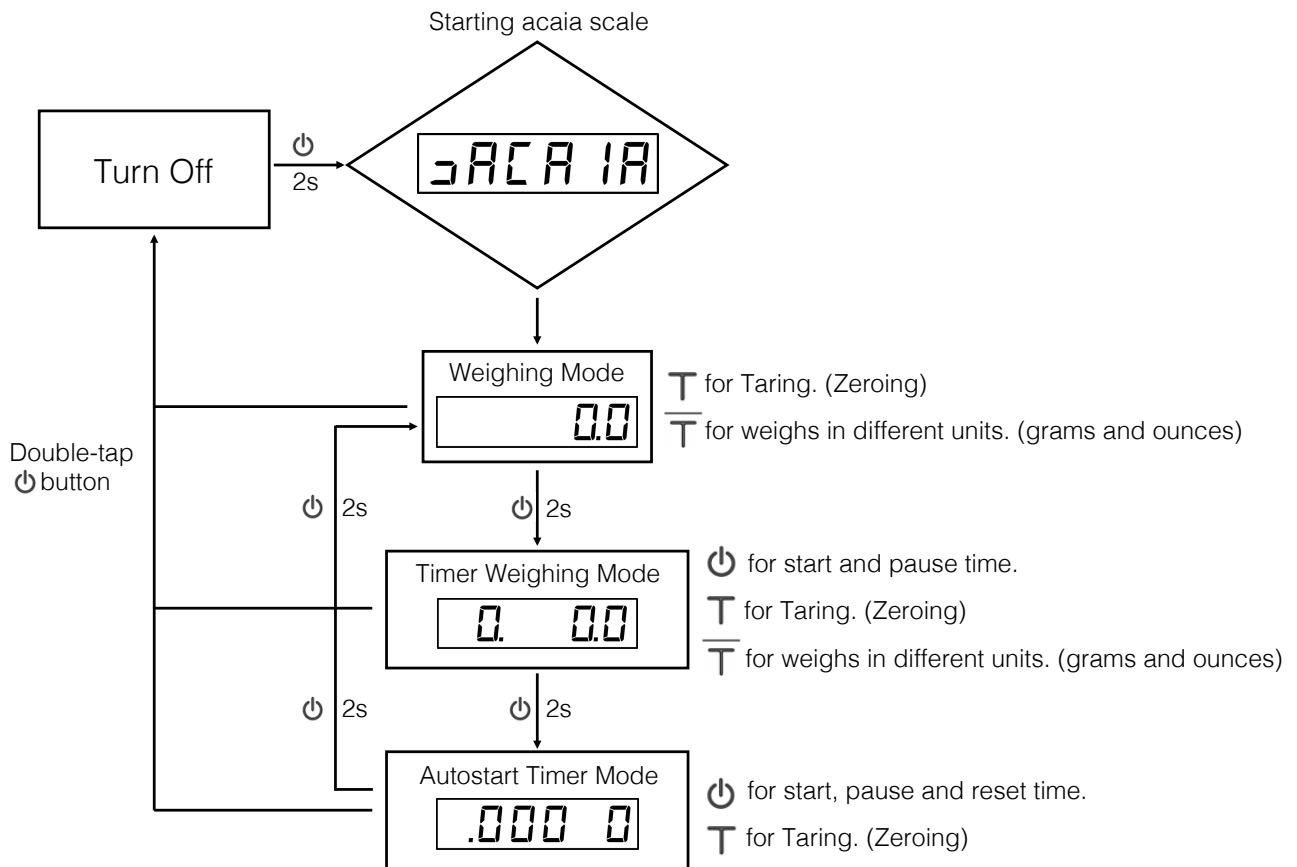

Key operations:

 Click  key.

 Press and hold  key for about 2 seconds.

 Click  key.

Weighing Mode

Display

- There are two different weighing units in Weighing Mode: grams and ounces.
- The readability is 0.1g for grams and 0.005oz for ounces.
- The LED display shows  when the weighing unit is in gram.

Operation

1. Press \overline{T} button for tare (zero) operation.
2. In Weight only mode, press and hold \overline{T} button for 2 seconds to switch the weighing unit in between gram and ounce.
3. Press and hold  button for 2 seconds to switch to Timer Mode.

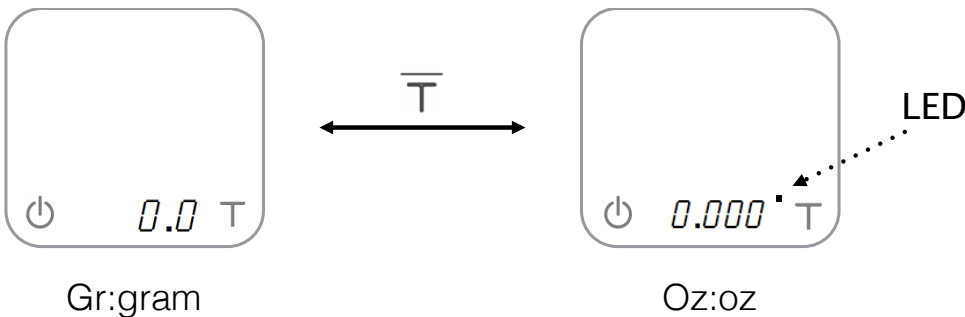

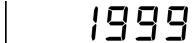

Timer-Weighing Mode

Display

1. The LED display shows  in Timer-Weighing Mode with timer on the left and weighing result on the right.
2. The timer displays from 0 to 59 seconds in cycle and will reset when reaching 60 seconds. When it resets, the LED indicator on the left lights on in orange.
3. The readability decreases when the the weight is over 99.9. The LED display shows up to in  maximum.

Operation

1. Press  button to start or pause the timer.
2. Press \overline{T} button for tare (zero) operation.
3. Press and hold \overline{T} button for 2 seconds to stop and reset the timer.
4. Press and hold  button for 2 seconds to switch to Weighing Mode.

Autostart Timer Mode

1. Press PwrButton and LED indicator will blink – to indicate that it is ready for water. As soon as weight on Pearl increases (pouring water), the timer will auto start.
2. Press PwrButton again to stop, or – simply remove the filter.

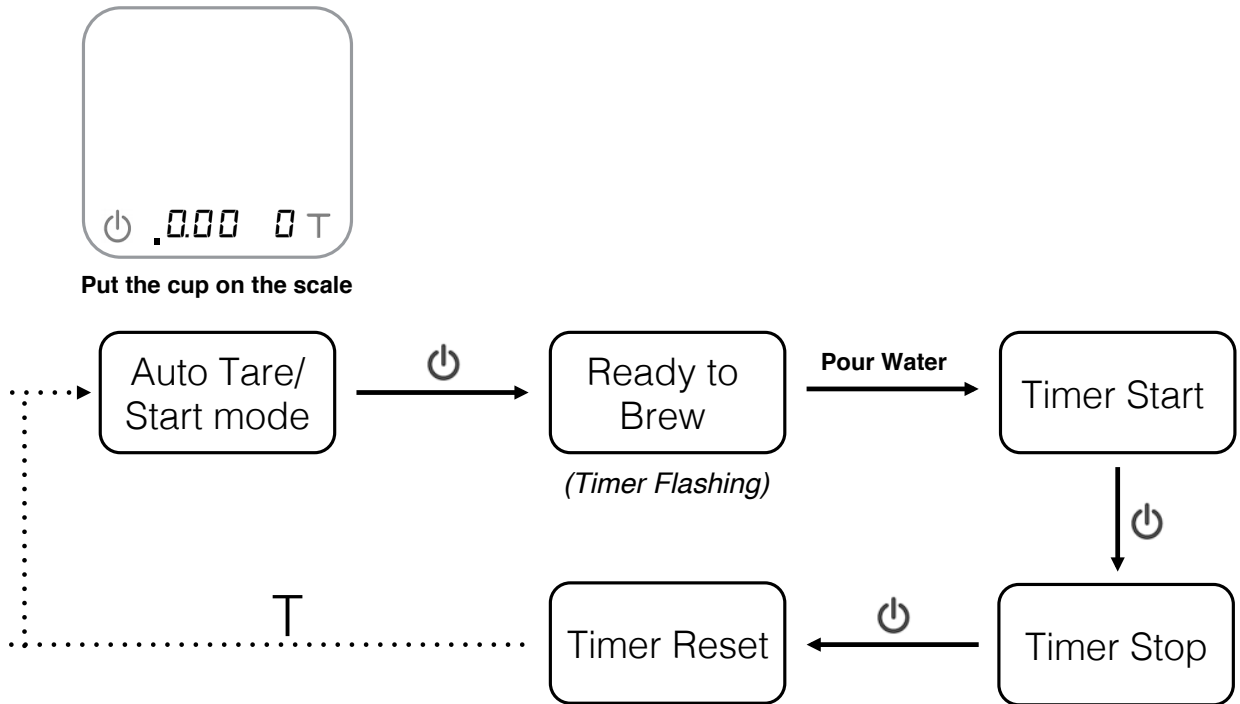

BEVERAGE WEIGHT MODE

1. Guides user through steps to prepare and remove equipment, and based on recorded weight, Pearl will estimate the weight of Beverage in the cup/container.
2. AFTER process, and filter is removed, the display will blink/toggle the water weight and Beverage weight (marked with “b”).
3. In short, the Pearl will show labels to indicate what to add, then you need to press Power to go to next step. As soon as weight is stabilized, next step will show in display.

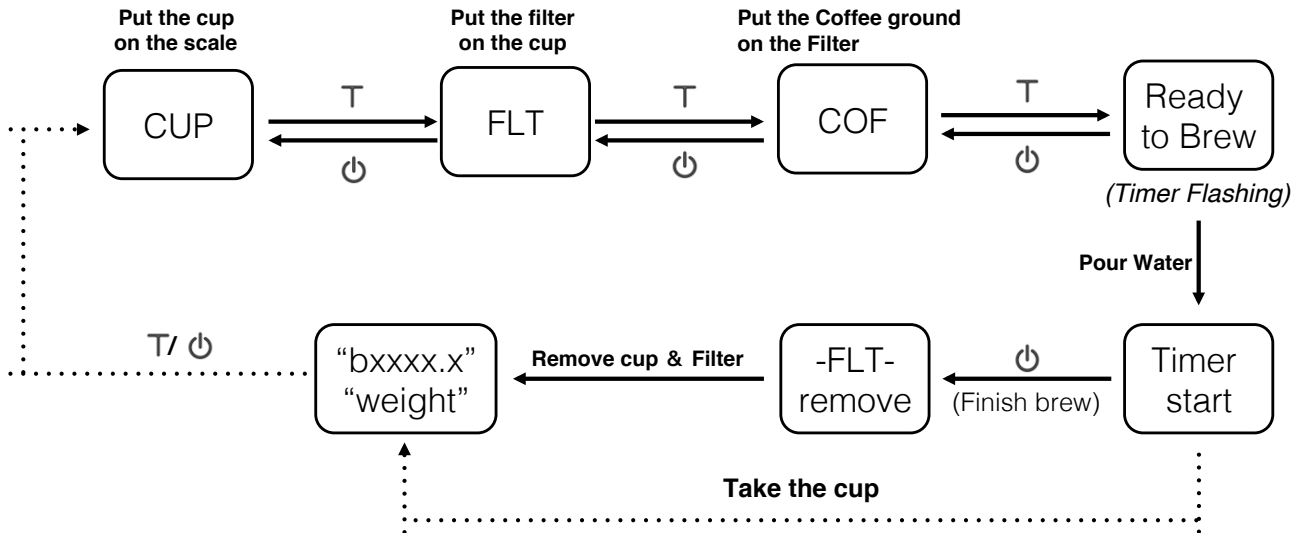

Chapter 4: Calibration

Calibration Mode

1. While the scale is in Weighing Mode and the weighing unit is in gram, press **T** button quickly multiple times until LED display shows [CAL] and then [500].
2. Place a 500g calibration weight on scale and wait for the scale to execute calibration procedure.
3. The LED display shows [-End-] when the calibration procedure is completed. You may unload the calibration weight when completed.

* Note: Calibration weight of 1000g, 1500g, or 2000g can also be used.







Creep Compensation Mode

1. While the scale is in Calibration Mode and the LED display shows [CAL] and then [500], press **T** button quickly multiple times until the LED display shows [CAL2] and then [500].
2. Place a 2000g calibration weight on scale and wait for the scale to execute creep compensation procedure.
3. The LED display shows [-End-] when the creep compensation procedure is completed. You may unload the calibration weight when completed.

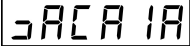
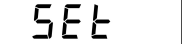

Chapter 5: Configuration

Setup Mode

Steps to enter Setup Mode

1. Press and hold  button while turning ON the scale. When the LED display shows  and  then , press and hold  button for another 2 seconds without releasing button. Release both  and  buttons when the display  shows with the very left 0 flashing.
2. Press and hold  button for 2 seconds to move the flashing digit to the right. Repeat this step for 4 times to enter the first setting in Setup Mode: the LED display  shows .

Key Operations in Setup Mode

1. Press  button to toggle through setting menu or the options under each setting.
2. Press and hold  button to enter each setting or to confirm the selected option.
3. Press  button to return to setting menu without saving or to return to Weighing Mode from setting menu.

Setup Mode Settings

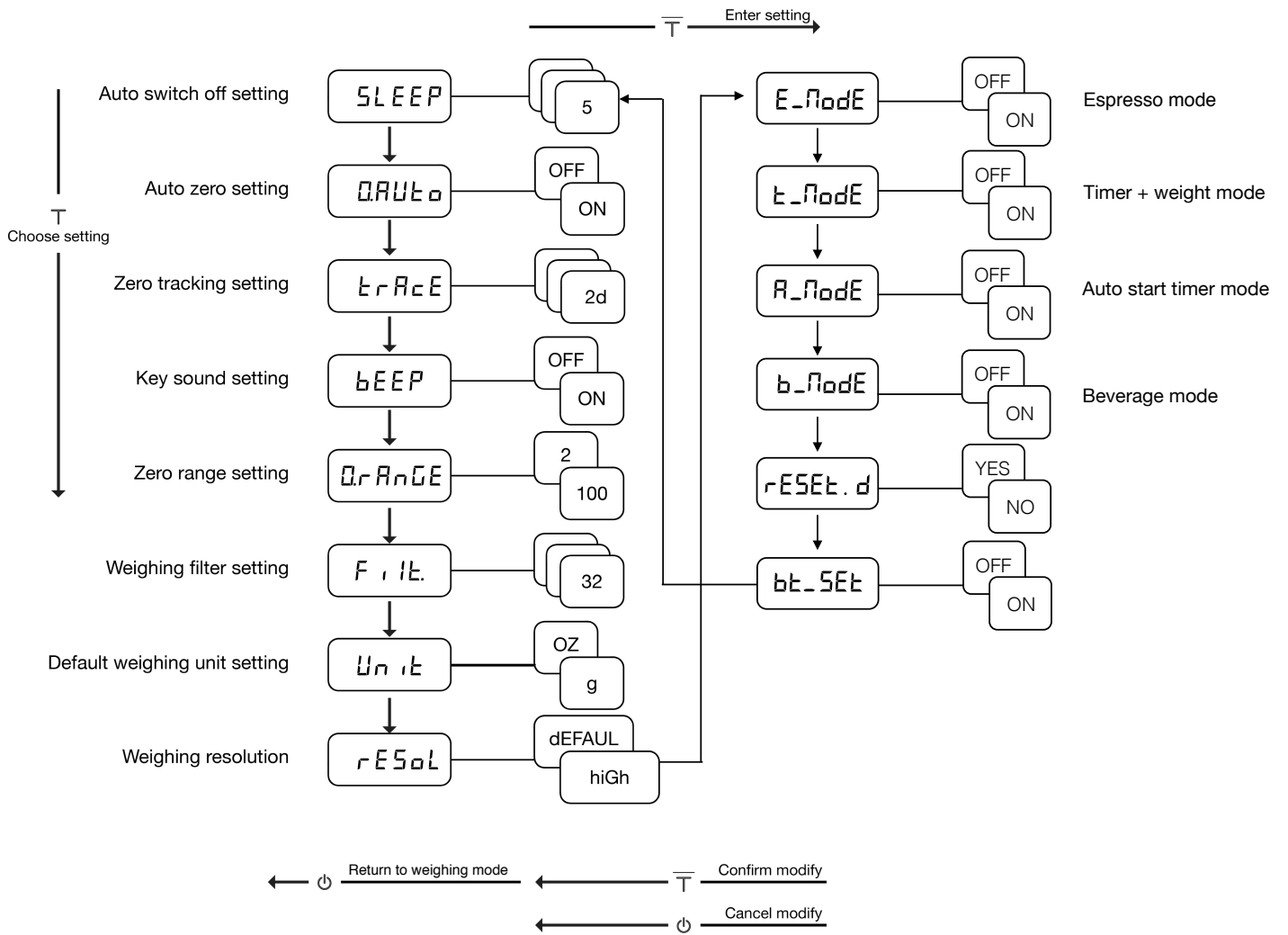

Key operations:

- T Click T key.
- T Press and hold T key for about 2 seconds.
- Power Click Power key.

Auto Sleep Settings

Auto Sleep Settings can also be configured in the Acaia App.

1. The number indicates the amount of time before the scale enters sleeping mode. For example, when 10 is selected, the scale enters sleeping mode after 10 minutes of idling.
2. Press \overline{T} button to toggle through the options.
3. Press and hold \overline{T} button for 2 seconds until the next setting, [0.AUto], is shown on LED to confirm the selected option.

Auto Zero Settings

1. When Auto Zero setting is off or disabled, the initial weight on weighing pan must be less than 50% of capacity, i.e., less than 1kg for Acaia coffee scale before the scale is turned on ; otherwise, an error [Er.303] occurs. When the error occurs, the scale would not work until the initial weight on weighing pan is cleared.
2. When Auto Zero setting is on or enabled, the scale displays the initial weight directly regardless whether the weight is over 50% of capacity.

Zero Tracking

Zero Tracking is a function for maintaining the zero indication within certain limits automatically.

1. OFF: It is not recommended to turn off the Zero Tracking because the zero indication would draft easily as room temperature changes.
2. 0.5d~3d: For example, since each division is 0.1g, 3d = 0.3g. When Zero Tracking is set to be 3d, any initial weight between +/- 0.3g on the weighing pan would be zeroed out.
3. 2d is recommended in general for Acaia coffee scale.

Key Sound Settings

Key Sound Settings can also be configured in the Acaia App.

- Set the Key Sound function off to turn off the beeping sound or on to turn on the beeping sound.

Zero Range Setting

Zero Range setting determines the range for which **T** button executes zero operation instead of tare operation.

1. When Zero Range is set to 2, the range for zero-setting will be 2% of the capacity, i.e., +/- 40g for Acaia coffee scale. By pressing **T** button, any weight within +/- 40g is zeroed out by zero operation while any weight lays outside the range is tared out by tare operation.
2. If Zero Range is set to 100, the range for zero-setting will be 100% of the capacity, i.e., +/- 2kg for Acaia coffee scale. Therefore, instead of tare operation, zero operation would be executed in this setting whenever **T** button is pressed.

Notice: The difference between zero operation and tare operation is that zero operation would simply ignore the weight and display as 0 while tare operation would deduct the weight from weighing result. However, zero operation does not increase the scale capacity.

Weighing filter setting

1. The number shown on LCD display indicates the current filter parameter which determines the speed for load receptor to response to weight and to determine the weighing value. The larger the number, the more stable but slower the weighing result will be.
2. Press **T** button to change the parameter.
3. Press and hold **T** button for 2 seconds until the next **Unit** setting, is shown on the LED to confirm the selected parameter.

Default Weighing Unit



1. The Default Weighing Unit is set to be gram if **g** is selected and ounce if **oz** is selected.
2. Press **T** button to switch the Default Weighing Unit between gram and ounce.
3. Press and hold **T** button for 2 seconds until **RESOL** is shown on LED to confirm the selected option.

Weighing resolution

1. The default Weighing Resolution is set to [dEFAUL]: the division is 0.1g under weight of 1000g and 0.5g from 1000g to 2000g.
2. Press **T** button to switch the weighing resolution between [dEFAUL] and [hiGh].
3. When the Weighing Resolution is set to high, division will be 0.1g throughout the entire time from 0g to 2000g.
4. Press and hold **T** button for 2 seconds until SLEEP is shown on LED to confirm the selected option.

Appendix

Error Code

Error Code	Description
100	Code error
101	EEPROM error
102	AD read error
	Over load: the weight is over the maximum capacity.
	Under load: the weight is under the minimum capacity.
303	Unable to make zero point, for the initial weight exceeds the limit (50% of capacity).
802	Unable to tare, for the weight exceeds the tare range.
803	Unable to tare, for the weight is unstable.
900	Password error (the default password is 0000)

Copyright

The operation manual is protected by copyright. All rights reserved. No part of the operation manual may be reproduced, processed, duplicated or published in any form by photocopying, microfilming, reprinting or any other method, in particular electronic means, without the written agreement of Acaia.

© Acaia, Cupertino, CA, 2014.