

# Electric Steam Tables

## Standard Features

- Fully insulated open wells—all four sides and bottom of wells are insulated by fiberglass, 8” deep, dry heating style, open well design
- Temperature control—individual infinite switch controls each well
- Two type heat elements—500 watt per well and 750 watt per well
- Stainless steel die-stamped opening—12”x20” rising lip around well helps keep well clean and makes food pans easy to load and unload
- Poly cutting board—7” wide x 1/2” thick with 18 gauge stainless steel support shelf and brackets
- 18 gauge stainless steel top, body and under shelf
- Stainless steel tubular legs with adjustable stainless steel feet, giving tables a strong structure
- Indicator light of each well shows both power on and element heating
- Mechanical guards on all switches for safety and reliability
- Standard with water pans

## Optional Accessories

- Casters (set of 4) item # CSTEAM-2-016
- Overshelf weight capacity: MROS-2ST: 50lbs, MROS-3ST: 70lbs, MROS-4ST: 80lbs, MROS-5ST: 85lbs

### MODELS:

CSTEAM-2C/CSTEAM-3C/CSTEAM-4C/CSTEB-5C

**CSTEAM-2C**



**CSTEB-5C**

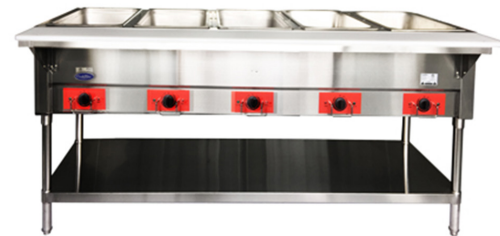

**CSTEAM-3C**



**CSTEAM-4C**

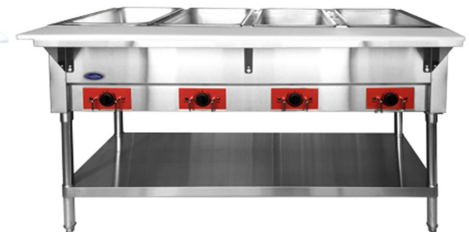

**MROS-2ST**



30<sup>1/5</sup> × 12<sup>1/5</sup> × 16<sup>1/10</sup>

**MROS-3ST**



44<sup>3/10</sup> × 12<sup>1/5</sup> × 16<sup>1/10</sup>

**MROS-4ST**



58<sup>2/5</sup> × 12<sup>1/5</sup> × 16<sup>1/10</sup>

**MROS-5ST**



72<sup>1/2</sup> × 12<sup>1/5</sup> × 16<sup>1/10</sup>



1 YEAR PARTS AND LABOR WARRANTY (US ONLY)



Conforms to ANSI  
STD Z83.11-2009 (2011)  
Certified for CSA  
STD 1.4B-2009 (2011)  
Conforms to NSF/ANSI STD.4



REV. 08/23

**“WE MAKE THE KITCHEN BETTER!”**

**SPECIFICATIONS**

Models	Voltage (V)	Wells	Watts/Well (W)	Total Watts	PH	Top Opening	Cu.ft.	Plug	Exterior Dimensions (inch)	Net Weight (lbs)	Gross Weight (lbs)
CSTEА-2C	120	2	500	1000	1	2	10.9	NEMA-5-15P	30×29 <sup>1/2</sup> ×33 <sup>1/2</sup>	64	77
CSTEА-3C	120	3	500	1500	1	3	15.5	NEMA-5-15P	44 <sup>1/8</sup> ×29 <sup>1/2</sup> ×33 <sup>1/2</sup>	84	104
CSTEА-4C	120	4	500	2000	1	4	19.8	NEMA-5-20P	58×29 <sup>1/2</sup> ×33 <sup>1/2</sup>	98	131
CSTЕB-5C	240	5	750	3750	1	5	29.7	NEMA-L6-20P	72 <sup>1/2</sup> ×29 <sup>1/2</sup> ×33 <sup>1/2</sup>	123	168

**PLAN VIEW**

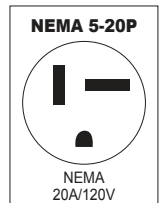
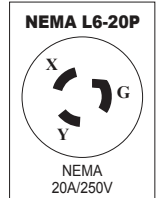
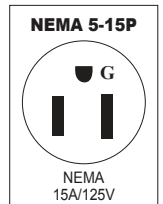
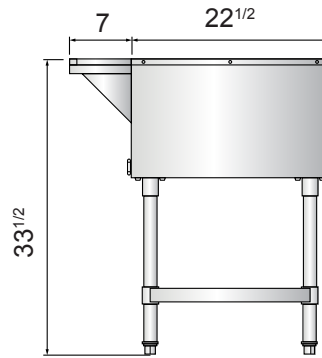
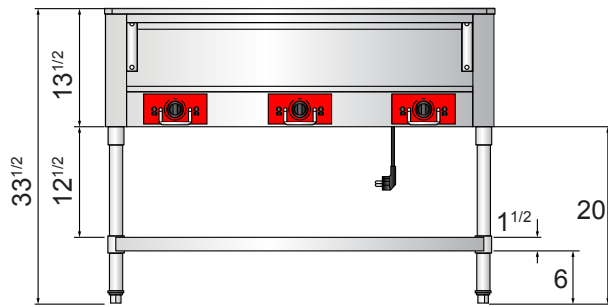
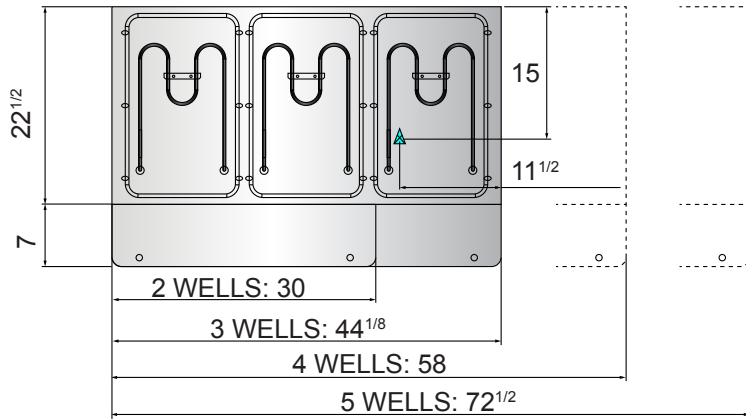

Fully insulated wells    Stainless steel exterior    Temperature control    Stainless steel legs

