

## Heating Indicator: & Load Shedding



This indicator shows when the pool is being heated. It will turn on and off automatically in auto and manual modes when heating is required.

## Load Shedding

(keeping power within design limits) is an arrangement predefined at manufacture which, dependent on system and components used, will switch the heating element off to keep within the controller's power limits.

## Miscellaneous:

The switch normally beeps every time a button is pushed. These can be switched off by holding down the up button and simultaneously pushing the light button. To switch on again repeat the above.

The display normally always returns to the pool temperature. If you want the display to stay on time, then pushing the display button until time is shown and pressing the down button will lock the display in this mode. The temp display can be restored at any time by pushing the display button.

In the event of electrical interference this unit automatically resets to a pre-determined safe state.

## Error codes :

- 01 - Stuck button
- 02 - No controller data
- 03 - Temperature sensor
- 04 - Water sensor
- 05 - Pool over temperature
- 06 - Heater thermal cutout
- 07 - Stuck heater relay
- 08 - Not used
- 09 - Water prime failed

### Warning:

If the supply cord is damaged, it shall be replaced by the manufacturer or its service agent or similarly qualified person in order to avoid hazard.

QuickSpaPwr1000-2speed-EMC, NRC



Dealer Stamp:

## QUICK CARD - USER GUIDE FOR THE SPA POWER 1000 SERIES SPA CONTROLLERS

Please read these instructions carefully



# SPA-QUIP



Manufactured By:  
Spa-Quip Ltd  
Cnr Rothwell Ave & Albany Hwy  
North Harbour Industrial Park  
Auckland, New Zealand  
Ph (649) 415 8622, Fax (649) 415 8621  
Email: [service@spa-quip.co.nz](mailto:service@spa-quip.co.nz)

Australian Distribution and Service:  
Spa-Quip (Australia) Pty Ltd  
Unit 2A, 4 Hudson Ave  
Castle Hill NSW 2154  
Ph (612) 9634 5600, Fax (612) 9634 5900  
Email: [service@spa-quip.com.au](mailto:service@spa-quip.com.au)

Web site: <http://www.spa-quip.co.nz>

## Important:

Before using check that the Spa Pool has been connected to a suitable weather protected outlet socket and Double Pole Isolating Switch with ratings as specified on the name plate of the control box. **Do not run this appliance on an extension lead.**

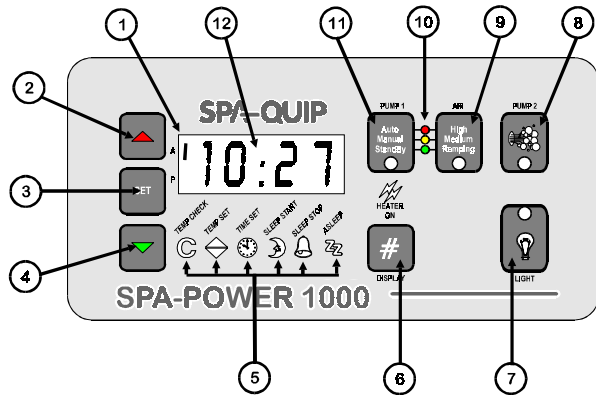

## 12: LCD Display

The Backlit Liquid Crystal Display can display five different quantities:

- The currently sensed pool temperature.
- The target pool temperature
- The time of day
- The sleep start time
- The sleep finish time

In addition the LCD can also show diagnostic fault codes.

## 2 & 4: Up Down Buttons

These two buttons are used to adjust the controller settings as shown on the LCD Display, after pushing the set button.

## 3: Set Button

To make any changes to the stored settings select the setting required using the display button. The icon and display will change to indicate your choice. Press the set button and the display will flash the current value. Adjust to the required value by pressing the up/down buttons. If you change your mind, pressing the display button will cancel any changes. To keep changes press the set button again. The display will always

revert to the water temperature reading after a short time. By following the above procedure the desired pool temperature can be set, the time of day and the sleep start and finish times. The time of day and sleep times will need to be set the first time the controller is powered up or if it has been turned off for a long period. If the sleep start = finish time the sleep mode is deactivated.

## 5: Icons

 This Icon is lit by default. When lit the LCD display is measuring the in pool temperature. For accurate readings it is advisable to run the pump for several minutes in manual mode to mix up the pool water.

 When lit the desired pool temperature can be adjusted typically to 37°C (default) or to that which is comfortable.

 This Icon indicates that the time of day is being displayed. Time can be adjusted remembering to set for AM or PM as indicated on the display ①.

 When lit the display shows the time at which the controller will start its sleep mode. This is a very handy feature and is used to silence the spa pool during your hours of sleep. Typically settings are between 12pm & 7am. The spa can be used within the sleep hours without having to change any times by pressing the pump 1 button so that the controller is in manual mode.

 This icon indicates the wake up time from sleep mode. It is normal for the spa to run for a long period after sleep to recover temperature lost over night. The time should be set approx. one hour before a spa is desired.

 This indicator is lit when the controller is asleep. Manual operation will over ride any sleep settings if the spa is required during the preset hours.

## 6: Display Button

This button cycles through the above icons and LCD displays allowing viewing or adjustment of the controller's main settings.

## 7: Light Button

This button controls the pool light. A green LED indicates when the light is on.

## 8: Pump 2 Button

This button controls the booster pump. A green LED indicates when the pump is on.

## 9: Air Button

The air switch has three modes. Successive pushes select high speed (red LED), medium speed (orange LED) and blower ramping up and down in speed (green LED).

*Options = 1 speed, 2 speed, 3 speed or 2 speed and ramping*

## Note:

There is an automatic timeout of the blower, booster pump and light. All three will automatically switch off together 30 minutes after the last push of their respective buttons.

## 10: Mimic Panel



## 11: Pump 1 Button

Pushes of this switch selects the main operating modes of the spa system.

- Auto Mode** (red LED) is the default start up mode where the pump, heating and filtration are automatically controlled.
- Manual Mode** (orange LED) where the user can control the main circulation pump even when the system is asleep. The heating will turn on/off automatically as required. This mode may have two speeds. The first position is slow speed with the LED flashing and the second is high speed with the LED constant.
- Stand-by Mode** (green LED) where the user can turn all Pump 1 functions off for absolute quiet. This mode reverts to auto mode after a preset time.

## Note:

The manual and stand-by modes will automatically revert to auto after a factory set time. If additional filtration time for example is required then pushing the button for manual mode will give an additional filtration period and allows it to time out by itself back to auto. There is a time delay of a few seconds between the pump switching on and the heater turning on, and between the heater switching off and the pump switching off.