

SV Mini

user manual



SV Mini 1
SV Mini 2

spanet

Table of Contents

WARNINGS	3
ELECTRICAL INSTALLATION	4
Wiring Diagram (Mini 1)	4
Wiring Diagram (Mini 2)	5
DIP SWITCHES	5
TOPSIDE PANELS	6
SV Mini 1 Layout	6
SV Mini 2 Layout	6
LED Indicator Lights	7
Display Modes	7
SETTING THE DATE/TIME	8
AUTOMATIC HEATING / FILTRATION	9
Adjusting Set Temperature	9
PUMP OPERATION	10
SV Mini 1 Pump Buttons	10
SV Mini 2 Pump Buttons	10
BLOWER OPERATION	11
Variable Speed Mode	11
Ramping Mode	11
LIGHT OPERATION	12
Selecting Light Colour or Effect Mode	12
KEYLOCK FUNCTION	13
Full Lock	13
Partial Lock	13
AUTO DAILY SANITISE	13
SETUP MENU	13
FILT – Filtration (total hours per day)	14
SNZE – Sleep Timer	14
D.DIS – Default Display	15
WIFI – WiFi Setup	15
H.PMP – Heat Pump Mode	15
H.ELE – Heat Pump + SV Element Boost	15
HEATING CONTROL & PROTECTION	15
Fast Heat Cycle	15
Freeze Protection	16
Defrost Cycle (heat pump models only)	16
Overheat Protection	16
ERROR CODES / TROUBLESHOOTING	17
Contact Us	19

WARNINGS

Risk of electrical shock

- **ALL ELECTRICAL CONNECTIONS MUST BE PERFORMED BY A LICENSED ELECTRICIAN AND MUST CONFORM TO ALL NATIONAL, STATE AND LOCAL ELECTRICAL CODES IN EFFECT AT THE TIME OF INSTALLATION.**
- **The appliance should be supplied through a residual current device (RCD) having a rated residual operating current not exceeding 30mA.**
- The appliance must be connected to a suitable rated and weather protected power supply. The supply line should be a dedicated power circuit and means for disconnection must be incorporated in the fixed wiring in accordance with your local wiring regulations. Means for disconnection from the supply mains should have a contact separation in all poles that provide full disconnection under over voltage Category III conditions.
- Earthed appliances must be permanently connected to fixed wiring (European models only).
- The appliance contains no serviceable parts. Do not attempt service of this control pack. Contact your dealer or authorised service agent for assistance.
- Turn the mains power OFF before servicing appliance or modifying any cable connection.
- Suitable for indoor use only or when installed under a weatherproof spa skirt. The appliance should be installed in an enclosure such that all electrical connections cannot be accessible to the user without the use of a tool.
- Low voltage or improper wiring may cause damage to this appliance. Read and follow all wiring instructions when connecting to power supply.
- If the supply cord is damaged it must be replaced by the manufacturer, its service agent, licensed electrician or similarly qualified persons in order to avoid a hazard.
- To prevent electric shock hazard and/or water damage to this appliance, all unused receptacles must have a water proof seal in place.
- Parts incorporating electrical components must be located or fixed so that they cannot fall into the bath or spa.
- Parts containing live parts, except parts supplied with safety extra-low voltage not exceeding 12V must be inaccessible to a person in the bath or spa.
- This appliance must NOT be installed in proximity to highly flammable materials.
- Water temperature in excess of 38°C may cause hyperthermia (heat stress).
- It is the spa manufacturer's and/or installer's responsibility to select suitable loads and configure load shed settings (if required) to ensure the system does not exceed its rated maximum total load.
- It is the installer's responsibility to ensure the floor can support the expected load of the bath or spa and an adequate drainage system has to be provided to deal with overflow water.
- A whirlpool spa should incorporate a water filtration system where the required level of water purity can be achieved.
- An adequate drainage system must be provided if the equipment is to be installed in a pit.
- This appliance is not intended for use by persons (including children) with reduced physical, sensory or mental capabilities, or lack of experience and knowledge, unless they have been given supervision or instruction concerning use of the appliance by a person responsible for their safety.
- Children should be supervised to ensure that they do not play with the appliance.

ELECTRICAL INSTALLATION

- All electrical connections must be performed by a licensed electrician and must conform to all national, state and local electrical codes in effect at the time of installation.
- The appliance should be supplied through a residual current device (RCD) having a rated residual operating current not exceeding 30mA.
- The supply line should be a dedicated power circuit. The installer should consider the sum total load of all devices connected to the SV Mini controller when determining the size of the power circuit and install an appropriately sized circuit breaker to suit. Ensure circuit breaker is rated for motor start up currents. Maximum rated power circuit is 25A.
- Heater load shedding is set by default, so that the heater load sheds and turns off as soon as any device other than Pump 1 is switched on. The installer should consider this when determining the size of the power circuit required. Heater load shedding can be adjusted if desired.

Electrical Specifications

Model	Max Current	Input Voltage	Phases	Hz	Heater Size
Mini 1 / Mini 2	25A	230-240V AC	1	50/60	1.5kW / 2.0kW / 3.0kW

Wiring Diagram (Mini 1)

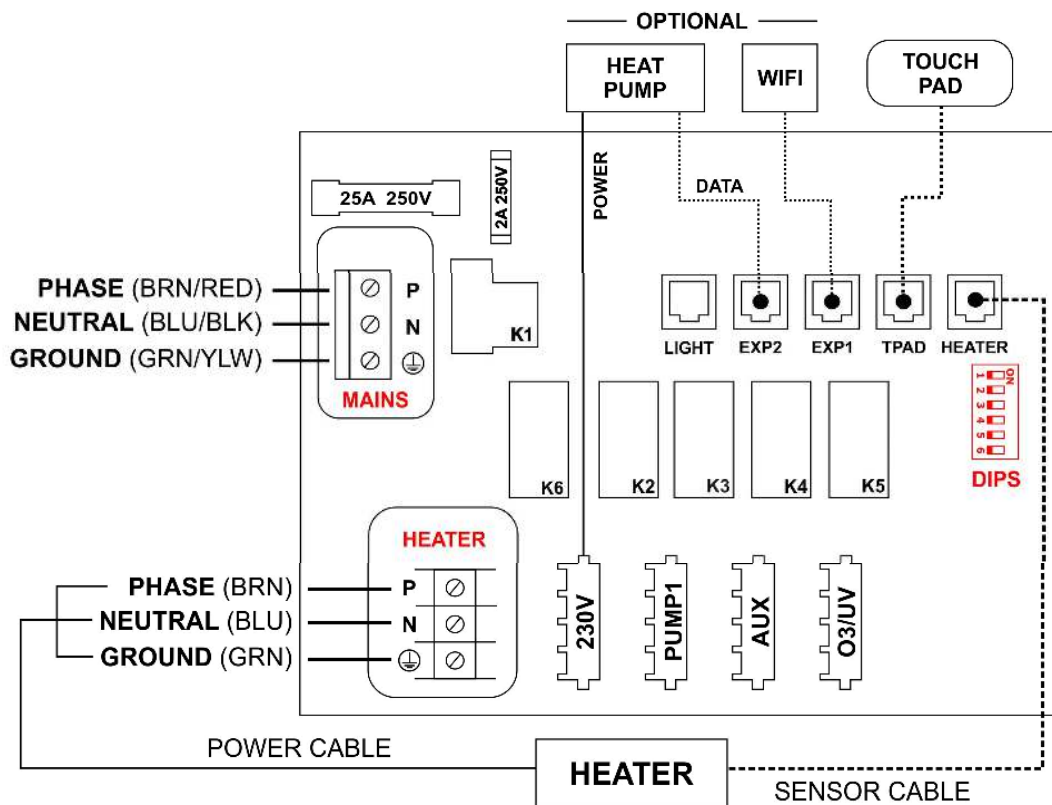

Output Ratings

Model	Outlet	Max Current	Output Voltage	Hz	Typical Accessory
SV Mini 1	230V	10A	230-240V AC	50/60	Heat Pump / Stereo
	Pump 1	10A	230-240V AC	50/60	Circ / 2-spd or 1-spd Pump
	Aux	10A	230-240V AC	50/60	1-spd Pump / Air Blower
	03/UV	2A	230-240V AC	50/60	Ozone / UV Sanitiser

Wiring Diagram (Mini 2)

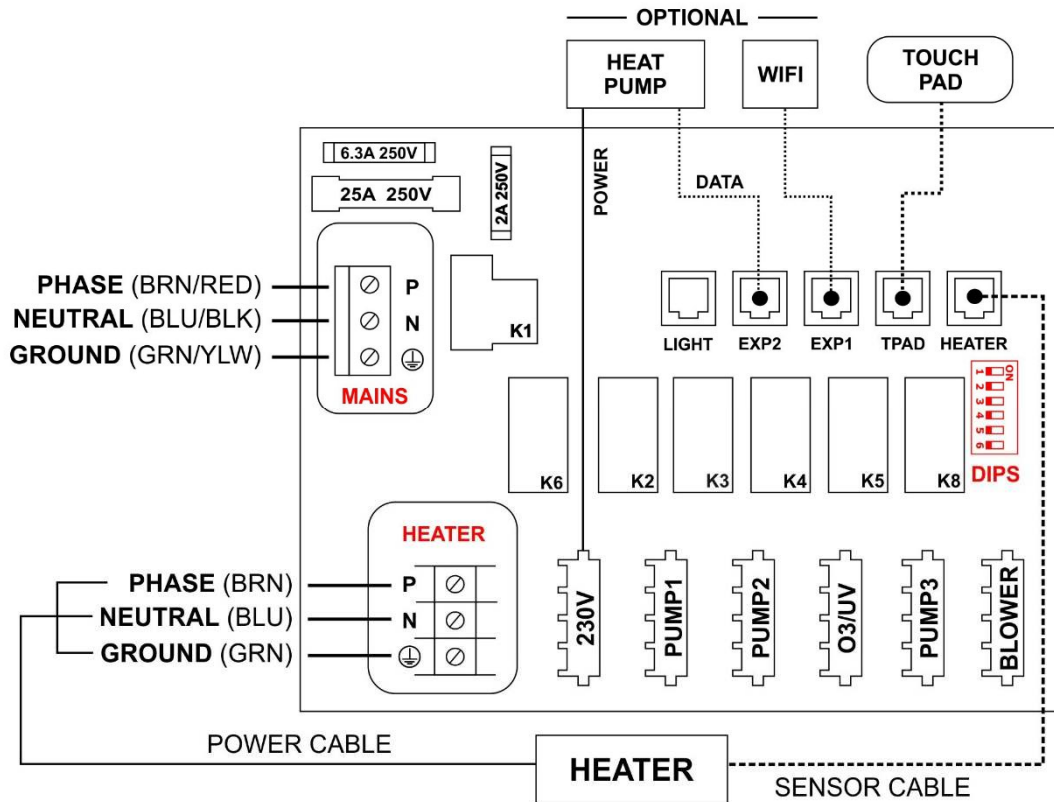

Output Ratings

Model	Outlet	Max Current	Output Voltage	Hz	Typical Accessory
SV Mini 2	230V	10A	230-240V AC	50/60	Heat Pump / Stereo
	Pump 1	10A	230-240V AC	50/60	Circ / 2-spd or 1-spd Pump
	Pump 2	10A	230-240V AC	50/60	1-spd Pump
	O3/UV	2A	230-240V AC	50/60	Ozone / UV Sanitiser
	Pump 3	10A	230-240V AC	50/60	1-spd Pump
	Blower	4.5A	230-240V AC	50/60	Air Blower

DIP SWITCHES

The dip switches determine the configuration of pumps connected to the SV Mini controllers. The installer must correctly configure the dip switches to match the pump(s) connected to the spa controller. The dip switch bank (illustrated below) has six individual switches. Switches set to the right of the switch bank (away from the numbers) are in the ON position. Switches set to the left of the switch bank (closest to the numbers) are in the OFF position. Refer to diagram below for dip switch settings:

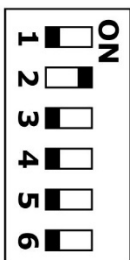

SW	Setting	OFF (left)	ON (right)	Notes
1	Not used	-	-	
2	Pump 1 Type	Single Speed	Two Speed	Determines if P1 = 1spd/2spd
3	Pump 3 Fitted *	Not Fitted	Fitted	Determines if P3 is connected
4	Not used	-	-	
5	Not used	-	-	
6	Not used	-	-	

* SV Mini 2 models only

NOTE: The dip switches will already be set by your spa manufacturer during production and should not require adjusting. This information is for reference when installing a new control to an existing spa.

TOPSIDE PANELS

SV Mini 1 Layout

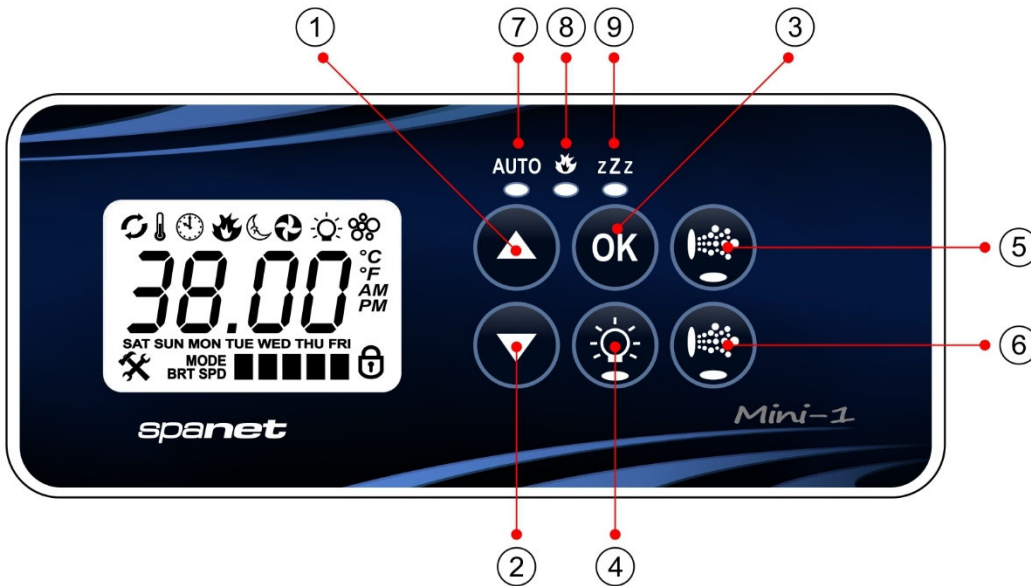

1. UP button
2. DOWN button
3. OK button
4. Light On/Off
5. Pump A
6. Auxiliary
7. Auto mode LED
8. Heater on LED
9. Sleep Cycle LED

SV Mini 2 Layout



1. UP button
2. DOWN button
3. OK button
4. Light On/Off
5. Pump A
6. Pump B
7. Pump C
8. Air Blower
9. Sleep Cycle LED
10. Heater on LED
11. Sleep Cycle LED

DISPLAY MODE ICONS

- Water Temperature
- Set Temperature
- Clock

MENU ICONS

- Sleep timer menu icon
- Light menu icon
- Blower menu icon

STATUS ICONS

- Keypad locked
- Sanitise cycle operating
- Filtration cycle operating
- Fault condition has occurred

LED Indicator Lights

The topside panel function buttons (i.e. Pumps, Light, and Blower) feature a green LED light to clearly indicate whether the accessory is ON or OFF. The green LED will light up when the accessory is ON. In addition, the topside panels have three red indicator LEDs to advise the user the current status of the spa:

AUTO AUTOMATIC MODE

The AUTO LED indicator turns ON when the filtration pump is in automatic mode. In automatic mode the filtration pump will turn on / off as required to satisfy heating and filtration requirements. If the filtration pump is manually turned on or off the AUTO LED indicator turns OFF. The control will automatically return to AUTO mode after a 45 minute idle timeout period if not returned to AUTO mode by the spa user.



HEATER ON

The Heater LED indicator turns ON when the heater element is active. The heater is automatically controlled, it will turn ON and OFF as required (in conjunction with the filtration pump) to maintain the set water temperature. If the filtration pump is manually turned OFF the heater will NOT operate.



NOTE: In some configurations, engaging high speed on a 2 speed pump or operating multiple pumps will cause the heater to load shed and turn OFF (even if heating is required) to keep the system within its rated power supply.

ZZZ SLEEP CYCLE ON

The Sleep Cycle LED indicator turns ON when the spa control is within a designated sleep cycle (if set). During a sleep cycle, all automatic system operation will stop so that the spa is silent – i.e. filtration and heating will not occur.

Display Modes

The SV Mini has three (3) x display modes. The spa user can scroll through the different displays by pressing a short single press of either the UP (▲) or DOWN (▼) button. Each display has a unique icon to indicate the current mode being viewed. As you scroll through each mode a brief title screen will be shown followed by the actual display mode (note change in icon). The available display modes are as follows:

ICON	TITLE	DISPLAY	NOTES:
	W.TMP	Water Temperature	1. The default display mode is (W.TMP) water temperature.
	S.TMP	Set Temperature	2. There is a 10 second inactivity timeout on all non-default displays. No button press for 10 secs display reverts to default.
	TIME	Clock	3. If no icon is displayed the temp shown is from when the filter pump last ran. Once the filter pump next runs for 10 mins the temp will update and W.TMP icon will return.

OTHER DISPLAY ICONS



Filtration Cycle

The spa is carrying out filtration



Keypad Locked

The keypad has been locked



Sanitise Cycle

The spa is carrying out a sanitisation cycle



System Error

A fault has been detected. The system has halted operation so that corrective action can be taken. Take note of scrolling error code and consult trouble shooting section of this manual.



SET DATE/TIME BEFORE USING THE SPA

Vital control functions require the date & time to be set correctly. Be sure to accurately set the date and time before operating the spa.

WATER CHEMISTRY MAINTENANCE

It is your responsibility to regularly check and maintain the chemical water balance of the spa pool to ensure it remains within reasonable pH (acid/alkaline) limits => (7.4 - 7.6 pH). Unbalanced water chemistry greatly accelerates corrosion and may lead to early product or component failure. **Product or component failures caused as a result of poor water chemistry maintenance will NOT be covered by the SpaNET™ Product Warranty.** We recommend you carry out a daily water chemistry test to correctly maintain the pH balance within reasonable limits.

SETTING THE DATE/TIME

Be sure to set the date and time before operating the spa. Vital functions such as filtration, sanitisation cycles and sleep timer settings depend on the time and date being set correctly.

- Press a short single press of the DOWN button to change display to Time/Clock setting
- Press the OK button to enter date/time adjustment
- The settings appear in the following order:
 - o Time Format (24 hr / 12 hr)
 - o Year (yyyy)
 - o Month (mm)
 - o Day (dd)
 - o Weekday (mon-sun)
 - o Hours (xx:00)
 - o Minutes (00:xx)
- Press the UP or DOWN buttons to adjust each setting
- Press the OK button to confirm each setting and skip to the next one
- Once the minutes have been selected and confirmed the system will exit the date/time adjustment and the display will return to the default display mode

NOTES:

1. Leap years are taken into account.
2. The system does not automatically adjust for daylight savings times. User must adjust manually.
3. The date/time clock has a capacitor backup which will hold the date/time even if mains power is turned off. The capacitor backup will last 8-12 hours. If power remains off for longer than this period the date/time may need to be set again.

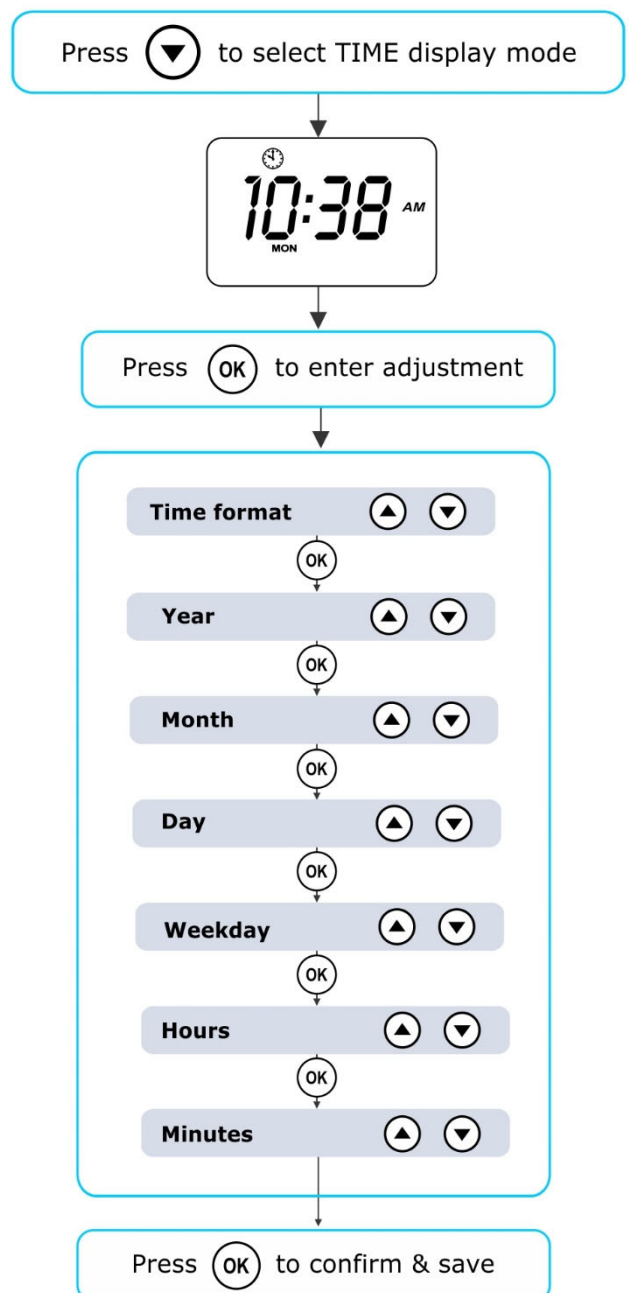

AUTOMATIC HEATING / FILTRATION

The SV Mini spa controls have been designed with simplicity in mind. Their intelligent software constantly monitors the spa water, automatically controlling the heater and filtration pump to ensure the desired set water temperature is maintained and required level of daily filtration achieved.

With set-and-forget technology, the spa user simply selects their desired water temperature (10°C - 41°C. Default = 38°C) and thereafter the spa control will automatically heat to and maintain that selected water temperature. This is called demand heating - the filtration pump and heater will be activated when required to maintain the set water temperature. The time spent heating the pool and running the filtration pump under normal operation will be taken into account and where required the pump will run for additional periods every three hours to maintain the minimum level of daily filtration as set by the user.

Dependant on the amount of normal spa use, set water temperature, minimum hours of filtration per day, climatic conditions and season being experienced, the spa control will engage the heater and / or filtration pump for differing periods of time, at differing times of day. The advanced software constantly monitors and recalculates after each heating / filtration cycle to ensure the correct daily filtration time is achieved and desired set water temperature is maintained.

Unless adjusted the SV controller will automatically heat to and maintain the default temperature of 38°C. The water temperature set point can be adjusted from 10°C to 41°C in steps of 0.2°C increments.

Adjusting Set Temperature

- Press and hold the UP or DOWN button to begin set temperature adjustment
- The display will show the (S.TMP) set temperature indicator icon, the main digits flash and temperature will begin adjusting
- Press the UP or DOWN buttons to adjust the set temperature by 0.2°C increments to your desired temperature
- Press OK to confirm and save setting, or wait for the 10 second idle timeout. The main digits will stop flashing and display returns to default display mode

NOTES:

1. During a heating cycle the SV Mini may raise the water temperature up to 0.5°C above set temperature point to provide an average water temperature of set point at most times.

2. If an optional heat pump is **NOT fitted** the spa controller has **NO** ability to cool the spa water. Lowering the set temperature point will **NOT** cause the water to cool.

3. If an optional heat pump **IS fitted** the spa water **CAN** be cooled as well as heated. Lowering the set temperature point will ensure the heat pump engages/disengages a cooling cycle (if required) to maintain the desired set water temperature so long as H.PMP mode is set to AUTO.

4. If the spa control has been in standby mode (idle) for some time and the set temperature point is adjusted, the filtration/circulation pump may run for up to ten (10) minutes to complete a mixing cycle before the heater / heat pump engages to heat or cool (heat pump only) the water. To skip this mixing cycle and begin heating/(cooling) immediately press the PUMP A button multiple times to toggle the filtration pump through ON/OFF/AUTO. Once AUTO is re-engaged the heater will activate immediately.

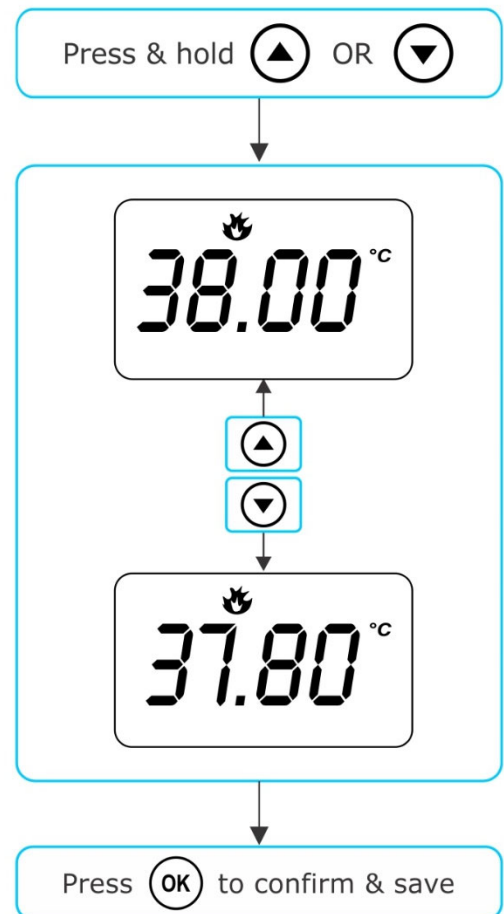

PUMP OPERATION

A designated filtration pump (pump 1) will automatically switch on and off as required to perform filtration and heating functions. All pump(s) will also operate for a short period during the daily sanitise cycle. In addition, the following manual pump controls are provided and will override automatic control.

The pump buttons are located on the right-hand side of the topside panels. The functions of the pump buttons change depending on pump configuration, however the Pump-A button is used to control the filtration pump (pump 1). For every press of a pump button the screen will temporarily display the selected pump state: ON, OFF, LOW, HIGH or AUTO and then revert to the default display mode. Possible pump configurations & button sequences are referenced in the tables below:

SV Mini 1 Pump Buttons

SPA CONFIGURATION	PUMP A BUTTON	AUXILIARY BUTTON
Pump 1 = 2 speed Aux = Not Fitted	2 speed pump: Low / High / Off / Auto	-
Pump 1 = 1 speed Aux = Not Fitted	1 speed pump: On / Off / Auto	-
Pump 1 = 2 speed Aux = 1 speed or Blower	2 speed pump: Low / High / Off / Auto	1 speed pump or Blower: On / Off
Pump 1 = Circ or 1 speed Aux = 1 speed or Blower	Circ pump or 1 speed pump: On / Off / Auto	1 speed pump or Blower: On / Off

SV Mini 2 Pump Buttons

SPA CONFIGURATION	PUMP A	PUMP B	PUMP C	BLOWER
Pump 1 = 2 speed Pump 2 = 1 speed Pump 3 = Not Fitted Blower = Fitted	2 speed pump: Low / High / Off / Auto	1 speed: On / Off	-	Vari / Ramp /Off
Pump 1 = Circ or 1 spd Pump 2 = 1 speed Pump 3 = Not Fitted Blower = Fitted	Circ pump or 1 spd: On / Off / Auto	1 speed: On / Off	-	Vari / Ramp /Off
Pump 1 = Circ Pump 2 = 1 speed Pump 3 = 1 speed Blower = Not Fitted	Circ pump: On / Off / Auto	1 speed: On / Off	1 speed: On / Off	-
Pump 1 = Circ Pump 2 = 1 speed Pump 3 = 1 speed Blower = Not Fitted	Circ pump: On / Off / Auto	1 speed: On / Off	1 speed: On / Off	Vari / Ramp /Off

NOTES:

1. If left ON, pumps automatically turn OFF after a 30 minute time-out period from the last button press.
2. If pump 1 is operating and heater is ON and pump is to be switched OFF, the pump will turn off after a 5 second delay – to allow the heater to cool down.
3. In some configurations, engaging high speed on a 2 speed pump or operating multiple pumps will cause the heater to load shed and turn OFF (even if heating is required) to keep the system within its available power supply.

BLOWER OPERATION

SV Mini 2 Models Only

SV Mini 2 models feature a dedicated air blower power socket and button. The blower button is used to toggle the air blower ON/OFF and allow adjustment of the blower speed. The selected speed is saved and will be restored the next time the blower is turned on, for future on/off use. Two modes of operation are provided.

Variable Speed Mode

- Press the BLOWER button once to activate blower in variable speed mode
- Display will flash VARI then present the blower speed (b.SPД) adjustment menu
- Press the UP or DOWN buttons to increase/decrease blower speed
- Press the OK button to confirm or wait for 10 second idle time-out
- Once running press the BLOWER button again to turn blower OFF

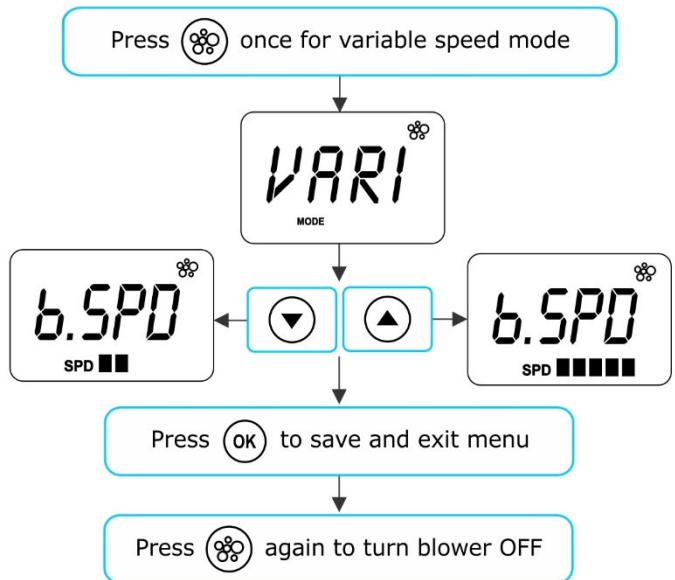

Ramping Mode

- Press the BLOWER button TWICE to activate blower in ramping mode
- Display will flash RAMP and blower operates in a ramping speed manner
- Once running press the BLOWER button again to turn blower OFF

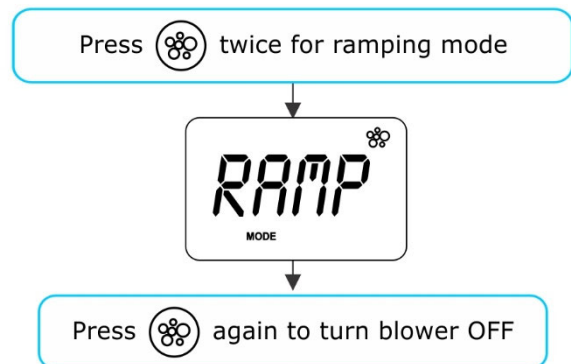

NOTES:

1. When blower is first turned ON it will always run at maximum speed for 3-4 seconds before changing to the last used speed.
2. If left ON, blower will automatically turn OFF after a 30 minute time-out period from the last button press.



LIGHT OPERATION

Multi-colour LED lighting effects

The light button is used to toggle the spa light(s) ON / OFF and to access the light mode menus. The features that can be adjusted are the light colour, light effect mode, light effect transition speed, and light brightness. All light settings are saved and will be restored the next time the light is turned ON, for future ON / OFF use.

Selecting Light Colour or Effect Mode

Press the LIGHT  button to turn light(s) on/off => light will display last used light mode. If no changes are required there is no need to do anything further. If however you wish to adjust the light settings refer below:

Use the UP  or DOWN  buttons to toggle between the two light modes:

TITLE	MODE	DESCRIPTION
U.CLR	User Colour	Select from 7 possible colours
FADE	Fade Effect	Fade transition through all colours



User Colour Mode

If user colour mode is selected press OK or wait 10 seconds for the display to show the current selected colour number. There are 7 colours to choose from (CL:00 – CL:07). Use the UP or DOWN buttons to adjust the colour. Press OK to confirm and skip to the light brightness adjustment or wait for the 10 second inactivity time out.



Fade Effect Mode

If fade effect mode is selected press OK or wait 10 seconds for the display to show the light speed (L.SPD) adjustment screen where the speed of the fade transition between colours can be adjusted. Use the UP or DOWN buttons to increase or decrease the transition speed to your desired level. Press OK to confirm and skip to the light brightness adjustment or wait for the 10 second inactivity time out.



Light Brightness

Once light mode and colour or light speed has been selected the controller offers a light brightness adjustment. Use the UP or DOWN buttons to increase/decrease the light brightness to your desired level. Press OK to confirm or wait for the 10 second inactivity timeout.



NOTES:

1. The light mode / user colour / light speed / light brightness adjustment screens are only displayed for 10 seconds each when the light(s) are first turned ON. If no adjustment is made the light(s) will run as per the last used settings, and the screen will time-out and revert to the default display mode. If you wish to adjust the light(s) settings once the light(s) have been running for a period of time, the light(s) must be turned OFF and back ON again to restore the light mode adjustment screens.

2. If left ON, the light(s) will automatically turn OFF after a 45 minute time out period from the last button press.

KEYLOCK FUNCTION

How to set full or partial keylock

The keypad buttons can be locked to prevent accidental key presses or to limit access to certain controller functions. This feature is helpful where children are present or spa is used by many people.

There are two types of keylock:

Full Lock All buttons are disabled

Partial Lock Allows use of pumps, blower and light but locks out settings and temperature adjustments

Full Lock

- Press and hold **UP + DOWN + PUMP A** until LOCK appears on the display
- Once locked if any button is pressed the key stroke will be ignored and display will show LOCK
- To unlock press and hold **UP + DOWN + PUMP A**



Partial Lock

- Press and hold **UP + DOWN + PUMP B** until LOCK appears on the display
- Once locked only pumps, blower and light can be used. Other key strokes will be ignored and display will show LOCK
- To unlock press and hold **UP + DOWN + PUMP B**



AUTO DAILY SANITISE

The controller will automatically run a 10 minute sanitise cycle every day at 9:00am. This sanitisation cycle runs the filtration pump and ozone/UV (if fitted) to filter the pool water to restore and refresh water quality. If pump 1 is a 2 speed pump the pump will run in high speed for the duration of the cycle. In addition at the start and end of the cycle the controller will sequentially run any additional accessories (auxiliary, pump2, pump3 or blower if fitted) for one minute each to purge the plumbing and clear any unfiltered water trapped in those accessory lines.

NOTES:

1. If the controller is in a programmed sleep period at 9:00am it will wait until the sleep period ends before the daily sanitise cycle runs.

2. If the spa is in use prior to the 9:00am sanitise cycle start time the cycle is cancelled for the day. Spa in use = button has been pressed and spa has not had the 45 minute inactivity time out expire since the last button press.

SETUP MENU

The SV Mini controllers feature a setup menu which allows customisation of adjustable software settings. These settings do not need to be modified often and in most cases the default settings are all that is required, however if the spa owner wishes to customise any settings it is completed through the setup menu.

- To access the setup menu press and hold the UP + DOWN buttons simultaneously until display shows FILT
- Use the UP or DOWN buttons to navigate through setup menu items
- Press the OK button to enter setting adjustment
- Press the UP or DOWN buttons to adjust setting
- Press the OK button to confirm and save the setting adjustment

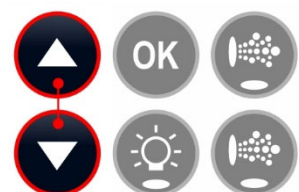

Refer table on the following page for details on setup menu items:

Setup Menu List

ITEM	SETTING	NOTES
FILT	Hours of filtration per day	Adjustable from 1 to 24 hours
SNZE	Sleep Timer Menu	
1.SNZ	Sleep timer 1	[1.DAY] Days of week, [1.BGN] Begin Time, [1.END] End Time
D.DIS	Default display mode	Water Temp (W.TMP) / Set Temp (S.TMP) / Clock (TIME)
WIFI	WiFi Setup Menu	
HOT	Hot spot mode	Activates hot spot mode for WiFi setup process
INFR	Infrastructure mode	Force a disconnect/reconnect to WiFi server to refresh connection
RSET	Reset WiFi module	Deletes all settings and prepares WiFi module for setup process
H.PMP*	Heat pump mode	Auto (heat & cool) / Heat only / Cool only / Off (HP disabled)
H.ELE*	HP + element boost	Off = heat pump only, electric heater disabled (default setting) On = heat pump + electric heater combined for heating

* *H.PMP and H.ELE setup menu items will only be visible if a SV Series heat pump is installed and connected to the SV Mini control.*

Notes:

1. The setup menu settings are stored in non-volatile memory (EEPROM) and are remembered when the mains power is turned OFF. No need to reprogram settings when power is restored.
2. A ten (10) second idle menu time out period exists. If a button press is not detected for 10 seconds the menu will time out and the screen will return to the default display mode.

FILT – Filtration (total hours per day)

Automatic filtration is provided to ensure that the pool water is filtered for at least a minimum number of hours each day. Total daily runtime can be adjusted from 1-24 hours (default = 2 hours). Total filtration runtime is broken into smaller blocks which occur every three hours. All time spent running the pump under normal operation (manual use, heating, sanitise cycle) will be taken into account and where required the pump will run for additional periods throughout the day to maintain the minimum level of daily filtration as specified by the user.

SNZE – Sleep Timer

The sleep timer is a very handy feature that enables the user to stop all spa activity and silence the spa during certain times of day or night. While the controller is sleeping NO automatic heating or filtration maintenance will occur, however the spa can still be operated by manual use without the need to adjust sleep time settings. The sleep timer setup consists of defining days of operation and begin time and end time of sleep period. Use the UP or DOWN button to adjust each setting within the sleep setup and press OK to confirm and skip to the next setting. Sleep timer settings are referenced in the table below:

TITLE	SETTING	OPTIONS
1.DAY	Selected days of operation	Sat-Fri (7 days), Sat-Sun (weekend), Mon-Fri (weekdays), OFF
1.BGN	Time sleep period begins	Adjustable to any time 0:00 to 23:59 (Default = 22:00 PM)
1.END	Time sleep period ends	Adjustable to any time 0:00 to 23:59 (Default = 07:00 AM)

Notes:

1. SV Mini is preset with a default sleep timer – 7 days a week, begin 22:00 (10PM), end 07:00 (7AM)
2. Set 1.DAY=OFF to disable sleep timer
3. If spa in use at begin time of sleep period, spa will not sleep until 45 min inactivity timeout has elapsed

D.DIS – Default Display

The user can adjust the default display mode to show their preferred selection of either: **W.TMP** (water temperature), **S.TMP** (set temperature) or **TIME** (current time and day).

WIFI – WiFi Setup

This menu is only of use if the optional SpaNET SmartLINK or SmartSTREAM WiFi module has been installed and connected to the SV Mini. This menu has three commands that can be executed. Use the UP or DOWN buttons to select desired command and press the OK button to execute – display will show WAIT whilst the WiFi module carries out the command.

- HOT** Puts WiFi module in hot spot mode for initial app setup. Note: Once initial app setup has been completed if the HOT command is executed again all WiFi settings will be lost and the app setup process must be run again.
- INFR** Forces WiFi module to disconnect/reconnect from the SpaNET app server to refresh connection if spa is not automatically coming online once the app setup process has been completed.
- RSET** Deletes programmed settings from WiFi module and returns the module to its factory default state. Note: If this command is executed settings are lost and the app setup process must be run again.

H.PMP – Heat Pump Mode

This setting is only visible if a SV Series heat pump is connected and defines heat pump operating mode. The available operating modes are as follows:

- AUTO** Heat pump will heat and cool
- HEAT** Heat pump will only heat (Default)
- COOL** Heat pump will only cool
- OFF** Heat pump disabled

H.ELE – Heat Pump + SV Element Boost

This setting is only visible if a SV Series heat pump is connected and defines how the SV Mini electric heating element operates with a heat pump. By default, this setting is set to OFF which disables the electric heater using only the heat pump for heating. Set to ON to allow the electric element to run in conjunction with the heat pump to boost heating speed if the water temperature is 2°C or more below set temperature point or the heat pump has been operating for more than 1 hour and set point has not been achieved. The H.ELE setting choices are:

- OFF SV element disabled (heat pump only)
- ON SV element + Heat Pump for heating

HEATING CONTROL & PROTECTION

Fast Heat Cycle / Freeze and Overheat Protection

Fast Heat Cycle

After initial mains power on the SV Mini will perform a fast heat up cycle that enables continuous demand heating regardless of programmed/default sleep timer. Once the set temperature has been reached the fast heat up cycle is cancelled and normal operation resumes and sleep timer is obeyed. The purpose of a fast heat up cycle is to help the spa reach set temperature as soon as possible after it has been powered up. For new spas or spas refilled with cold water it is desirable not to have sleep time delaying the time to takes for the spa to reach set temperature point.

NOTES:

1. A fast heat up cycle is cancelled by manually forcing the filtration pump to OFF via the keypad
2. For new spas or when a spa has just been refilled it is common for spa users to test the operation of each pump when the power is first turned on. This process will cancel the fast heat up cycle. After completing testing of the spa functions remember to reset mains power if you wish to reactivate fast heat up cycle.

Freeze Protection

Freeze protection will be activated whenever the water temperature drops below 4°C. It runs back to back 10 minute sanitise cycles and displays "WARM" on the LCD. It also runs each spa accessory (i.e. jet pumps and air blower) in sequence to run water through the pipe work whilst running the filtration pump and heater. During the "WARM" cycle the heater and heat pump (if fitted) will operate however heater load shedding may occur when accessory pumps are running depending on control and load shed settings.

At the end of each 10 minute "WARM" cycle the water temperature is checked. If it is above 4°C freeze protection stops and the controller returns to its prior state. If the temperature is not above 4°C another cycle will run.

Note: Freeze protection overrides the sleep timer– if the water temperature drops below 4°C and the controller is in a sleep period it will wake up. So even if high amounts of sleep time and a low set temperature point have been programmed, the SV Mini will always maintain the water temperature at least above 4°C.

Defrost Cycle (heat pump models only)

During periods of low ambient temperatures defrost cycles may be required to prevent the heat pump's condenser from freezing. Ambient and condenser temperatures are constantly monitored and defrost cycles will be automatically activated if certain conditions are met. Defrost cycles run for a minimum of 3 minutes to a maximum of 10 minutes.

Overheat Protection

All SV controllers feature three forms of overheat protection:

1. If sensed water temperature within the heater unit exceeds safe working limits the heating element will be disabled and the controller will shut down and latch fault code (ER4 - Thermal Trip). Normal operation will not resume until heater element has cooled and mains power is reset
2. If sensed water temperature exceeds 42°C filtration is stopped until the temperature falls below 42°C to prevent heat rise from filtration pump operation
3. If sensed water temperature exceeds 45°C the controller will shut down and latch fault code (Er5 - Pool too hot). Normal operation will not resume until mains power is reset

ERROR CODES / TROUBLESHOOTING

SV spa controllers feature self-diagnostics and scrolling error messages to quickly troubleshoot possible problems. Should the spa control encounter a problem the error code / message will scroll across the topside panel screen until the problem is resolved. If an error condition is experienced all spa functions are shut down and the spa should not be used until the error condition has been resolved. A list of error codes with descriptions of problems and possible solutions is detailed below for your reference.

IMPORTANT NOTE

For most error codes mains power to the spa control must be turned OFF and then back ON before the error condition will be cleared. Before attempting any troubleshooting always ensure mains power is isolated and turned OFF.

Heartbeat LED

All SV Mini spa packs feature a red flashing heartbeat LED light. The heartbeat LED is located on the main printed circuit board of the spa pack itself (spa pack enclosure cover needs to be removed).

The heartbeat LED flashes to indicate the current health/status of the spa pack. When the spa pack is functioning correctly with no errors to report the heartbeat LED emits a single flash in a constant pulse much like a heartbeat (ON, OFF, ON, OFF). If the spa pack encounters a fault the heartbeat LED will begin flashing in sequence with the error code number being experienced (ie. ER2 = ON,ON; OFF ON,ON; OFF).

If the keypad display is ever blank a spa user can still determine the health / status of the SV Mini controller by removing a panel from the spa skirt and checking the heartbeat LED on the front of the spa pack itself.

ER-2 HEATER PLUG

Problem: No heater sensor communication

Cause: Heater sensor communication problem. Sensor cable is not correctly connected to spa control or is damaged

Solutions: Turn mains power OFF, remove spa cabinet panel and SV Mini enclosure cover
Check heater sensor cable is firmly plugged into spa control socket labelled HEATER
Unplug and re-plug heater sensor cable to re-establish connection to spa control
Check for damage to sensor lead, replace covers and test spa again
Contact spa reseller if problem is not resolved

ER-3 WATER PRIME

Problem: Water prime failed – air detected in heater tube

Cause: Airlock in pipe work, low water level, dirty filter cartridges

Solutions: Press Pump A button to retry water prime
Check spa water level (refill if necessary)
Remove filter cartridges and press Pump A button to retry prime
Bleed airlock from pipe work by slightly loosening couplings on front of filtration pump
Remove filter cartridges and flush water down pipe work with a hose

ER-4 THERMAL TRIP

Problem: Heater thermal trip activated. Heater has been active and has had insufficient water flow over the element. Low or no water flow has caused the heater temperature to exceed its maximum limits and the spa control has shut down operation to prevent any damage to the heater unit

ER-4 THERMAL TRIP

- Cause: Low water level, airlock in pipe work, closed shut-off valves, dirty filter cartridges, filtration pump failed or operation intermittent
- Solutions: Turn mains power OFF and wait 20-30 minutes for element to cool and thermal cut-out device to reset. Then turn power back ON
Check spa water level (refill if necessary)
Remove filters and clean as per manufacturer's recommendations or replace cartridges if required
Check under spa cabinet to ensure all shut-off valves are in the OPEN position
Bleed airlock from pipe work by slightly loosening couplings on front of filtration pump or by removing filters and flushing water down pipe work with a hose.
Contact your spa reseller if problem persists

ER-5 POOL TOO HOT

- Problem: Pool over temperature. Temperature sensor reading $\geq 45^{\circ}\text{C}$
- Cause: High ambient temperatures (especially in summer months) have caused water temperature to rise above set temp point, Excessive filtration time, Jet pumps have been operating for extended periods with the spa cover still on
- Solutions: Turn mains power OFF, remove spa cover, allow spa to cool then turn power back ON
Check daily filtration time (refer filtration section) and reduce daily filtration time if required
Check spa cover is not resting on topside panel buttons causing jet pumps to start when cover is on. Use keylock function to lock keypad buttons when spa not in use.
Contact your spa reseller if problem persists

ER-6 12V OVERLOAD

- Problem: 12V (port) current draw over 1A limit
- Cause: Total 12V current drawn by keypad(s), light(s), expansion ports and in pool temp sensor is excessive, 12V power supply is overloaded, too many LED light bulbs installed, faulty LED light
- Solutions: Turn mains power OFF and restart spa to see if problem reoccurs
Perform EPRM software reset to factory defaults
Reduce number of LED lights connected to spa control
Systematically unplug lights, keypads and expansion port loads from spa pack (one by one) to identify the faulty 12v device
Contact your spa reseller if problem persists

ER-8 CTRL FAULT HVS

- Problem: Heater relay is on when it should be off
- Cause: Power surge, periods of low or high voltage, water on spa pack terminal block, relay fault
- Solutions: Turn mains power OFF and back ON again to see if spa control recovers from ER8 fault
Inspect under spa cabinet for evidence of water leaking onto spa control. If water present, turn mains power OFF and isolate, then resolve leak, dry up excess water, and allow spa control to dry out before restoring power.
Contact your spa reseller if problem persists

Contact Us

Spa Net Pty Ltd

Unit 4
103 Railway Road North
Mulgrave NSW 2756
Australia

Phone: +61 2 4587 7766
Fax: +61 2 4587 8766

www.spanet.com.au

Technical Support & Service service@spanet.com.au

Accounts Department accounts@spanet.com.au

Sales Department sales@spanet.com.au