

WOOL AND THE GANG

#MADEUNIQUE



STIR IT UP TOP

EASY

6.5MM (US10.5) NEEDLES

© Wool and the Gang LTD. 2016

YOUR ADVENTURE STARTS NOW



IT'S FUN

Making is the new yoga. Free your mind, the rest will follow. Namaste.

WE'LL BE THERE FOR YOU

Find all the video tutorials you need online.

YOU'RE GOING TO FEEL GOOD

Nothing will make you happier than holding your finished project.

RECIPE FOR SUCCESS

1

GET YOUR TOOLS READY.

Everything you need to get making.

2

FAMILIARISE YOURSELF WITH THE TECHNIQUES.

Everything from the stitches used to the finishing touches for your project.

3

GET TO KNOW YOUR YARN.

Before you start your piece, play around with your new yarn to get used to it, and to check your tension.

4

WOOL SCHOOL

Pick up your needles & yarn and make the magic happen! For a little extra help, check out our Wool School at:

www.woolandthegang.com/t/how-to

5

#WOOLANDTHEGANG

When you're done - let the world know.

LET'S GET KNITTING

Tool kit

- 2 balls of WATG's Shiny Happy Cotton
- 1 pair of 6.5mm (10.5US) knitting needles
- 1 Stir It Up Top pattern
- 1 sewing needle

Tension

To ensure your knitting has the same measurements as the pattern, it is a good idea to make a tension swatch before you start knitting your project. A tension swatch is a small sample of your knitting where you count the stitches and rows and check them against the tension measurement given in the pattern. If you get MORE stitches/rows than the pattern's tension, it means your knitting is tighter. If you get FEWER stitches/rows than the pattern, your knitting is looser. Sometimes, it works to knit tighter or looser to compensate.

When you make your swatch, make sure it is large enough for you to measure 10 cm/4" without including the stitches/rows closest to the edges (as these often have a slightly different tension). When you're done swatching, simply unravel and re-use the yarn to start knitting your Stir It Up Top.

Stocking stitch

- 10 cm/4" = 13 stitches
- 10 cm/4" = 18 rows

Fishnet stitch

10 cm/4" = 12.5 stitches

10 cm/4" = 22 rows

All knitting techniques can be found at the back of the pattern.



Help's only a stitch away. Watch the video tutorials online at www.woolandthegang.com/t/how-to

Pssst! Remember that you must not copy our patterns and sell, or even give them away for free, in accordance with copyright law.

MEASUREMENTS

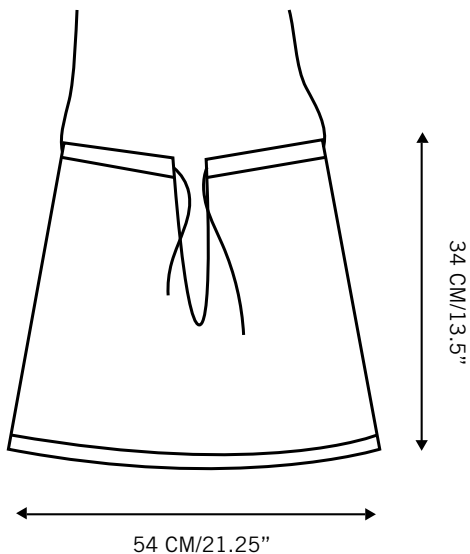

HOW TO KNIT YOUR STIR IT UP TOP

FRONT

- 1 Cast on 71 stitches using the cable cast on technique.

- 2 Work 8 rows in stocking stitch.

- 3 **Decrease row:** Knit 1 stitch, knit 2 stitches together. You will now start working in fishnet stitch as follows:

★Make a lace hole, knit the next 2 stitches together.★

Repeat the section inside the stars until you have 2 stitches left of your row, knit 2 stitches together. (69 stitches).

- 4 Knit 2 stitches, then work in fishnet stitch until you have just 1 stitch left, knit this stitch.

- 5 Repeat step 4 a further four times.

- 6 **Decrease row:** Knit 2 stitches, Knit 2 stitches together, then work in fishnet stitch until you have 3 stitches left. Knit 2 stitches together then knit the last stitch. (67 stitches).

- 7 Knit 3 stitches, then work in fishnet stitch until you have 2 stitches left, knit 2 stitches.

- 8 Repeat step 7 a further four times.
-
- 9 **Decrease row:** Knit 1 stitch, Knit 2 stitches together, then work in fishnet stitch until you have 2 stitches left. Knit 2 stitches together. (65 stitches).
-
- 10 Knit 2 stitches, then work in fishnet stitch until you have 1 stitch left, knit 1 stitch.
-
- 11 Repeat step 10 a further four times.
-
- 12 **Decrease row:** Knit 2 stitches, Knit 2 stitches together, then work in fishnet stitch until you have 3 stitches left. Knit 2 stitches together then knit the last stitch. (63 stitches).
-
- 13 Knit 3 stitches, then work in fishnet stitch until you have 2 stitches left, knit 2 stitches.
-
- 14 Repeat step 13 a further four times.
-
- 15 **Decrease row:** Repeat step 9 once more. (61 stitches).
-
- 16 Repeat step 10 a further seven times.
- The right side of the fabric should now be facing you.
-
- 17 Knit 2 stitches, then work in fishnet stitch until you have 30 stitches on your right needle
- Turn your work, you will now work across these 30
-

stitches to make the right side of the front - leave the remaining stitches on the needle for now, you will come back to them later.

- 18 Decrease row:** Knit 1 stitch, Knit 2 stitches together, then work in fishnet stitch until you have 1 stitch left. Knit 1 stitch. (29 stitches).
-
- 19** Knit 2 stitches, then work in fishnet stitch until you have 1 stitch left, knit 1 stitch.
-
- 20** Repeat step 19 a further three times.
-
- 21 Decrease row:** Knit 2 stitches, Knit 2 stitches together, then work in fishnet stitch until you have 3 stitches left. Knit 2 stitches together then knit the last stitch. (27 stitches).
-
- 22** Knit 3 stitches, then work in fishnet stitch until you have 2 stitches left, knit 2 stitches.
-
- 23** Repeat step 22 twice more
-
- 24 Decrease row:** Knit 1 stitch, Knit 2 stitches together, then work in fishnet stitch until you have 2 stitches left. Knit 2 stitches together. (25 stitches).
-
- 25** Knit 2 stitches, then work in fishnet stitch until you have 1 stitch left, knit 1 stitch.
-
- 26** Repeat step 25 a further four times.
-

- 27 Decrease row:** Knit 2 stitches, Knit 2 stitches together, then work in fishnet stitch until you have 3 stitches left. Knit 2 stitches together then knit the last stitch. (23 stitches).
-
- 28** Knit 3 stitches, then work in fishnet stitch until you have 2 stitches left, knit 2 stitches.
-
- 29** Repeat step 28 a further six times.
-
- 30 Decrease row:** Knit 1 stitch, Knit 2 stitches together, then work in fishnet stitch until you have 2 stitches left. Knit 2 stitches together. (21 stitches).
-
- 31** Knit 2 stitches, then work in fishnet stitch until you have 1 stitch left, knit 1 stitch.
-
- 32** Repeat step 31 a further eight times.
-
- 33** Work 8 rows in stocking stitch.
-
- 34** Cast off.

The right side is done - you will now work the left side. Re-join the yarn to the stitches that have been waiting on the needle, as if adding in a new ball of yarn.

- 35 Decrease row:** Knit 2 stitches, then work in fishnet stitch until you have 3 stitches left. Knit 2 stitches together then knit the last stitch. (30 stitches).
-

- 36 Decrease row:** Knit 3 stitches, then work in fishnet stitch until you have 3 stitches left. Knit 2 stitches together then knit the last stitch. (29 stitches).
-
- 37** Knit 3 stitches, then work in fishnet stitch until you have 2 stitches left, knit 2 stitches.
-
- 38** Repeat step 37 a further three times.
-
- 39 Decrease row:** Knit 1 stitch, Knit 2 stitches together, then work in fishnet stitch until you have 2 stitches left. Knit 2 stitches together. (27 stitches).
-
- 40** Knit 2 stitches, then work in fishnet stitch until you have 1 stitch left, knit 1 stitch.
-
- 41** Repeat step 40 twice more.
-
- 42 Decrease row:** Knit 2 stitches, Knit 2 stitches together, then work in fishnet stitch until you have 3 stitches left. Knit 2 stitches together then knit the last stitch. (25 stitches).
-
- 43** Knit 3 stitches, then work in fishnet stitch until you have 2 stitches left, knit 2 stitches.
-
- 44** Repeat step 43 a further four times.
-
- 45 Decrease row:** Knit 1 stitch, Knit 2 stitches together, then work in fishnet stitch until you have 2 stitches left. Knit 2 stitches together. (23 stitches).
-

- 46 Knit 2 stitches, then work in fishnet stitch until you have 1 stitch left, knit 1 stitch.
-
- 47 Repeat step 46 a further six times
-
- 48 **Decrease row:** Knit 2 stitches, Knit 2 stitches together, then work in fishnet stitch until you have 3 stitches left. Knit 2 stitches together then knit the last stitch. (21 stitches).
-
- 49 Knit 3 stitches, then work in fishnet stitch until you have 2 stitches left, knit 2 stitches.
-
- 50 Repeat step 49 a further eight times.
-
- 51 Work 8 rows in stocking stitch.
-
- 52 Cast off and weave in any loose ends.

BACK

- 1 Repeat steps 1 to 14 as for the front. (61 stitches.)
-
- 2 Wrong side row: Knit 2 stitches, then work in fishnet stitch until you have 1 stitch left, knit 1 stitch.
- The right side of the fabric should now be facing you.
-
- 3 Right side row: Knit 2 stitches, then work in fishnet stitch until you have 22 stitches on your right needle.
-

Knit 1 stitch.

Turn your work, you will now work across these 23 stitches to make the right side of the back - leave the remaining stitches on the needle for now, you will come back to them later.

-
- 4 Knit 2 stitches, then work in fishnet stitch until you have 1 stitch left, knit 1 stitch
-
- 5 **Decrease row:** Knit 2 stitches, then work in fishnet stitch until you have 3 stitches left. Knit 2 stitches together then knit the last stitch. (22 stitches).
-
- 6 Knit 3 stitches, then work in fishnet stitch until you have 1 stitch left, knit 1 stitch.
-
- 7 **Decrease row:** Knit 2 stitches, Knit 2 stitches together, then work in fishnet stitch until you have 2 stitches left. Knit 2 stitches together. (20 stitches).
-
- 8 Knit 2 stitches, then work in fishnet stitch until you have 2 stitches left, knit 2 stitches.
-
- 9 **Decrease row:** Knit 3 stitches, then work in fishnet stitch until you have 3 stitches left. Knit 2 stitches together then knit the last stitch. (19 stitches).
-
- 10 Knit 3 stitches, then work in fishnet stitch until you have 2 stitches left, knit 2 stitches.
-

- 11 Decrease row:** Knit 3 stitches, then work in fishnet stitch until you have 2 stitches left. Knit 2 stitches together. (18 stitches).
-
- 12** Knit 2 stitches, then work in fishnet stitch until you have 2 stitches left, knit 2 stitches.
-
- 13 Decrease row:** Knit 1 stitch, Knit 2 stitches together, then work in fishnet stitch until you have 3 stitches left. Knit 2 stitches together then knit the last stitch. (16 stitches).
-
- 14** Knit 3 stitches, then work in fishnet stitch until you have 1 stitch left, knit 1 stitch.
-
- 15 Decrease row:** Knit 2 stitches, then work in fishnet stitch until you have 2 stitches left. Knit 2 stitches together. (15 stitches).
-
- 16** Knit 2 stitches, then work in fishnet stitch until you have 1 stitch left, knit 1 stitch.
-
- 17 Decrease row:** Knit 2 stitches, Knit 2 stitches together, then work in fishnet stitch until you have 3 stitches left. Knit 2 stitches together then knit the last stitch. (13 stitches).
-
- 18** Knit 3 stitches, then work in fishnet stitch until you have 2 stitches left, knit 2 stitches.
-

- 19 Decrease row:** Knit 1 stitch, Knit 2 stitches together, then work in fishnet stitch until you have 2 stitches left. Knit 2 stitches together. (11 stitches).
-
- 20** Knit 2 stitches, then work in fishnet stitch until you have 1 stitch left, knit 1 stitch.
-
- 21 Decrease row:** Knit 2 stitches, then work in fishnet stitch until you have 3 stitches left. Knit 2 stitches together then knit the last stitch. (10 stitches).
-
- 22** Knit 3 stitches, then work in fishnet stitch until you have 1 stitch left, knit 1 stitch.
-
- 23 Decrease row:** Knit 2 stitches, then work in fishnet stitch until you have 2 stitches left. Knit 2 stitches together. (9 stitches).
-
- 24** Knit 2 stitches, then work in fishnet stitch until you have 1 stitch left, knit 1 stitch.
-
- 25 Decrease row:** Knit 2 stitches, Knit 2 stitches together, then work in fishnet stitch until you have 3 stitches left. Knit 2 stitches together then knit the last stitch. (7 stitches).
-
- 26** Knit 3 stitches, then work in fishnet stitch until you have 2 stitches left, knit 2 stitches.
-
- 27 Decrease row:** Knit 1 stitch, Knit 2 stitches together, then work in fishnet stitch until you have 2 stitches left.
-

Knit 2 stitches together. (5 stitches).

28 Decrease row: Knit 2 stitches together, then work in fishnet stitch until you have 1 stitch left. Knit the last stitch. (4 stitches).

29 Decrease row: ★ Knit 2 stitches together ★ Repeat the section inside the stars once more. (2 stitches).

30 Decrease row: Knit 2 stitches together. (1 stitch).

31 Cut the yarn approx. 15cm/6" from the last stitch. Pull the yarn end through the last stitch - you have now secured the last stitch.

32 The right side is done - you will now work the left side. Re-join the yarn to the stitches that have been waiting on the needle, as if adding in a new ball of yarn.

33 Cast off 15 stitches.

34 Knit 1 stitch, then work in fishnet stitch until you have 1 stitch left, knit 1 stitch.

35 Knit 2 stitches, then work in fishnet stitch until you have 1 stitch left, knit 1 stitch.

36 Decrease row: Knit 2 stitches, Knit 2 stitches together, then work in fishnet stitch until you have 1 stitch left, knit 1 stitch.(22 stitches).

- 37 Knit 2 stitches, then work in fishnet stitch until you have 2 stitches left, knit 2 stitches.
-
- 38 **Decrease row:** Knit 1 stitch, Knit 2 stitches together, then work in fishnet stitch until you have 3 stitches left. Knit 2 stitches together then knit the last stitch. (20 stitches).
-
- 39 Knit 3 stitches, then work in fishnet stitch until you have 1 stitch left, knit 1 stitch.
-
- 40 **Decrease row:** Knit 2 stitches, Knit 2 stitches together, then work in fishnet stitch until you have 2 stitches left, knit 2 stitches. (19 stitches).
-
- 41 Knit 3 stitches, then work in fishnet stitch until you have 2 stitches left, knit 2 stitches.
-
- 42 **Decrease row:** Knit 1 stitch, Knit 2 stitches together, then work in fishnet stitch until you have 2 stitches left. Knit 2 stitches. (18 stitches).
-
- 43 Knit 3 stitches, then work in fishnet stitch until you have 1 stitch left, knit 1 stitch.
-
- 44 **Decrease row:** Knit 2 stitches, Knit 2 stitches together, then work in fishnet stitch until you have 2 stitches left, knit 2 stitches together. (16 stitches).
-
- 45 Knit 2 stitches, then work in fishnet stitch until you have 2 stitches left, knit 2 stitches.
-

- 46 Decrease row:** Knit 1 stitch, Knit 2 stitches together, then work in fishnet stitch until you have 1 stitch left. Knit 1 stitch. (15 stitches).
-
- 47** Knit 2 stitches, then work in fishnet stitch until you have 1 stitch left, knit 1 stitch.
-
- 48 Decrease row:** Knit 1 stitch, Knit 2 stitches together, then work in fishnet stitch until you have 3 stitches left. Knit 2 stitches together then knit the last stitch. (13 stitches).
-
- 49** Knit 3 stitches, then work in fishnet stitch until you have 2 stitches left, knit 2 stitches.
-
- 50 Decrease row:** Knit 1 stitch, Knit 2 stitches together, then work in fishnet stitch until you have 2 stitches left. Knit 2 stitches together. (11 stitches).
-
- 51** Knit 2 stitches, then work in fishnet stitch until you have 1 stitch left, knit 1 stitch.
-
- 52 Decrease row:** Knit 2 stitches, Knit 2 stitches together, then work in fishnet stitch until you have 1 stitch left, knit 1 stitch.(10 stitches).
-
- 53** Knit 2 stitches, then work in fishnet stitch until you have 2 stitches left, knit 2 stitches.
-
- 54 Decrease row:** Knit 1 stitch, Knit 2 stitches together, then work in fishnet stitch until you have 1 stitch left.
-

Knit 1 stitch. (9 stitches).

55 Knit 2 stitches, then work in fishnet stitch until you have 1 stitch left, knit 1 stitch.

56 **Decrease row:** Knit 2 stitches, Knit 2 stitches together, then work in fishnet stitch until you have 3 stitches left. Knit 2 stitches together then knit the last stitch. (7 stitches).

57 Knit 3 stitches, then work in fishnet stitch until you have 2 stitches left, knit 2 stitches.

58 **Decrease row:** Knit 1 stitch, Knit 2 stitches together, then work in fishnet stitch until you have 2 stitches left. Knit 2 stitches together. (5 stitches).

59 **Decrease row:** Knit 2 stitches together, then work in fishnet stitch until you have 1 stitch left. Knit the last stitch. (4 stitches).

60 **Decrease row:** ★ Knit 2 stitches together ★ Repeat the section inside the stars once more. (2 stitches).

61 **Decrease row:** Knit 2 stitches together. (1 stitch).

62 Cut the yarn approx. 15cm/6" from the last stitch. Pull the yarn end through the last stitch - you have now secured the last stitch. Weave in any loose ends.

ASSEMBLY AND FINISHING

- 1 Place the back on top of the front piece, with the wrong sides touching.
- 2 Thread your sewing needle with a long strand of yarn, starting at the bottom edge, use the vertical invisible seam technique to sew the side edges together 19cm/7,5".

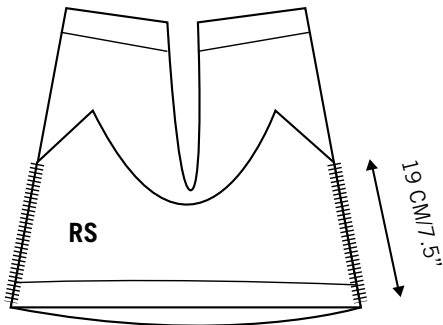

- 3 To make the roll edge trims around the front neckline and along the bottom edge, lay your top flat so that the wrong side is facing you. Fold the right side edge over 2cm/0.75" towards you to make the edge. Thread your sewing needle with a length of yarn and sew the cast on/off edge down onto the wrong side.
- 4 Weave in the loose ends.

BRAIDED STRAPS

- 1 Cut 3 strands of cotton, each measuring 180cm/70.8". Tie the strands together 8cm/3" from end.
- 2 Holding your yarn in 3 groups of 3 strands make a braid, until it measures approx 130cm/47.25"

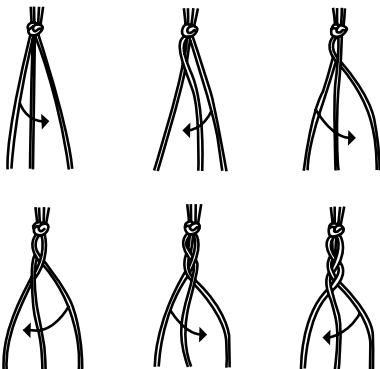

- 3 Tie a knot in the end of your braid. Trim the ends leaving a 8cm/3" tail.
- 4 Pull the braid from left to right through one of the top roll edge trims, leaving approx 35cm at the centre front.

- 5** Now, with the back of the top facing you, take the braid and thread it through the fabric at the opposing highest point of the back.

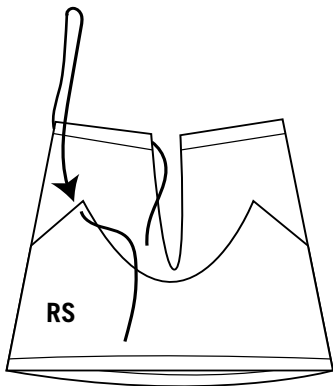

- 6** Repeat steps 1 to 5 once more for the other strap.
- 7** The straps are then tied together at the centre front and the centre back of the top depending on wearing preference.

KNITTING TECHNIQUES



Help's only a stitch away. Watch the video tutorials online at www.woolandthegang.com/t/how-to

Work! Work! Work!

There are two main ways to 'work' stitches: they can be knitted or purled. When the pattern asks you to 'work' a number of stitches/rows/cm, it will always specify which stitch pattern to work in.

Cable cast on / [Online video tutorial](#)

Create a slip knot on the left hand needle. Knit on one stitch, creating two stitches on the left hand needle. Now insert the right needle between the two stitches, wrap and bring through. Transfer the newly created stitch onto the left hand needle. Repeat until you have cast on the number of stitches indicated in the pattern.

Stocking stitch / [Online video tutorial](#)

A basic stitch pattern where you knit all the stitches of one row, then purl all the stitches of the next. These two rows are repeated to make the pattern. The 'right' side of the fabric looks like a series of 'Vs' and the 'wrong' side of the fabric looks like a series of 'waves'.

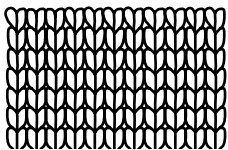

RIGHT SIDE

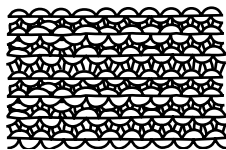

WRONG SIDE

Fishnet stitch / [▶ Online video tutorial](#)

For this simple lace pattern, you first need to know how to create a lace hole. To do this, start with the yarn at the back of the work, then bring it to the front by passing it between the two needles. Finally, return the yarn to the back by bringing it over the right needle. You have now created a new loop on the right needle - this is what forms your lace hole as you continue knitting. To work in fishnet stitch, repeat the section inside the little stars (★): ★ Make a lace hole, then knit two stitches together. ★

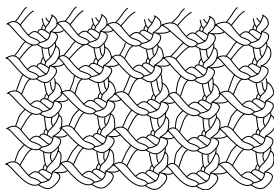

Decreasing / [▶ Online video tutorial](#)

Instead of knitting only one stitch at a time, knit two stitches together. Insert the front of your right needle through the first

two stitches on the left needle, then knit them together as a single stitch. For decreasing on purl rows, insert the needle through the two stitches from right to left and purl together as a single stitch. You can also do a double decrease by knitting or purling three stitches together in the same way.

Adding a new ball of yarn / [Online video tutorial](#)

When your ball of yarn runs out, or when you need to change the colour, tie a loose knot on to the tail with the new ball of yarn and slide it up to the needle. Tighten the knot. Continue knitting with the new yarn.

Casting off / [Online video tutorial](#)

To complete your project, you need to cast off your last row of stitches in order to make an edge that won't unravel. For your final row, knit the first two stitches. Using the tip of the left needle, lift the first stitch up and over the second stitch and then slip it off the right needle. Now you have only one stitch on your right needle. Knit the next stitch from the left needle, then lift the previous stitch over it and off the needle as before. Do this with each stitch until there are no stitches on the left needle and just one stitch on the right needle. Cut the yarn, leaving a 15 cm/6" end. Pull on the last loop until the end pops through - you've now secured the last stitch.

FINISHING TECHNIQUES

Vertical invisible seam / [▶ Online video tutorial](#)

This technique is used to join two side edges. Line up the edges side by side with the right side of the fabric facing up. Insert your sewing needle under the first horizontal bar between the first two stitches on the edge you want to join. Pull the yarn through and insert the needle through the opposite horizontal bar on the other piece. Sew back and forth through the horizontal bars along the edge. To tighten the stitches, pull the yarn gently - and they will disappear.

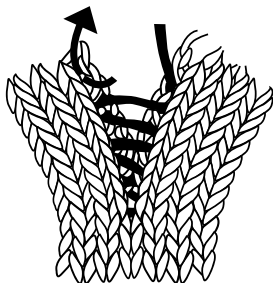

Rolled hem

To make the roll edge trims around the neckline and along the bottom edge, lay your sweater flat so that the wrong side is facing you. Fold the right side edge over 1cm/0.5" towards you to make the hem. Thread your sewing needle with a length of yarn and sew the cast on/off edge onto the wrong side.

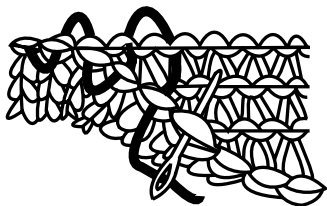

Weaving in the ends / [▶ Online video tutorial](#)

Weave the ends of your yarn into your knitting to finish it off and stop it from unravelling. Thread the tail onto the sewing needle. Weave the yarn along the edge of your knitting as shown in the illustration. Where you have started a new ball, weave one tail in one direction and the other tail in the opposite direction. Weave in approximately 10 cm/4", then cut the tail.

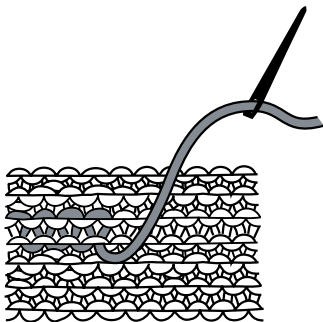

MAKING MEMOIRS

STARTED ON

FINISHED ON

WHERE I MADE IT

-

-

-

MADE FOR

Me

COLOUR COMBO

THIS PROJECT WAS

() easy peasy () nice () challenging () hardcore

I FEEL    

OTHER THOUGHTS

.....



Wool and the Gang



@woolandthegang



@woolandthegang



WATGsnaps



Wool and the Gang



woolandtheganghq

YOUR PROJECT DESERVES SOME SEXY YARN



CRAZY SEXY WOOL
100% Peruvian Wool



SUGAR BABY ALPACA
100% Baby Alpaca



WOOL ME TENDER
100% Peruvian Wool



JERSEY BE GOOD
98% Cotton
2% Elastane



MIXTAPE YARN
80% Cotton
20% Polyester



BILLIE JEAN
100% Upcycled Denim



SHINY HAPPY COTTON
100% Peruvian
Pima Cotton



WOOLY BULLY ALPACA
80% Superfine Alpaca
20% Merino Wool



SHEEPACA YARN
50% Baby Alpaca
50% Merino Wool



TAKE CARE MOHAIR
78% Kid Mohair
13% Wool / 9% Polyamide



FEELING GOOD
70% Baby Alpaca
7% Merino / 23% Nylon

**WOOL
AND THE
GANG**

V285588172

