

WOOL AND THE GANG

#MADEUNIQUE



JOE CARDIGAN INTERMEDIATE

US10.5 / 6.5MM CIRCULAR NEEDLES

© Wool and the Gang LTD. 2015

YOUR ADVENTURE STARTS NOW

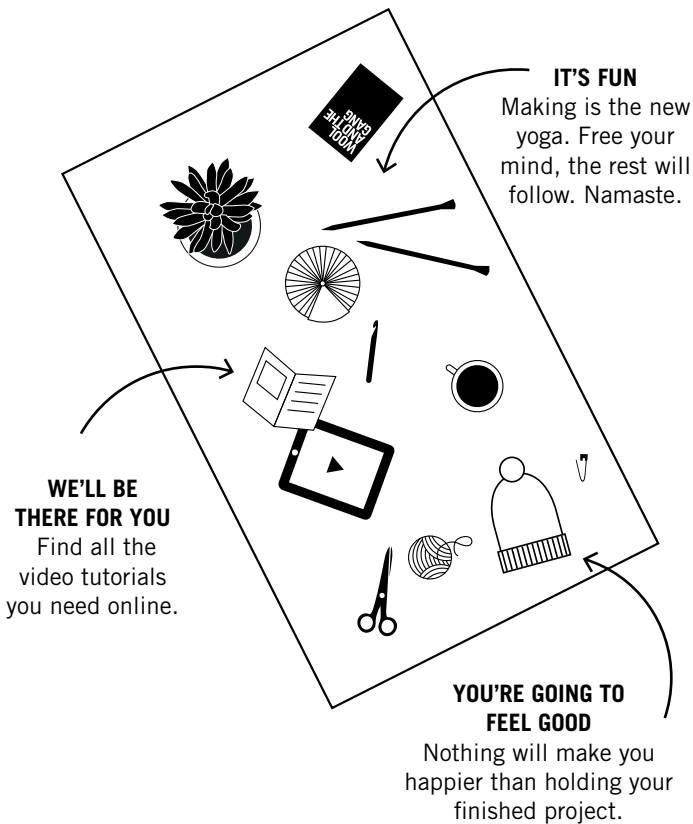

IT'S FUN

Making is the new yoga. Free your mind, the rest will follow. Namaste.

WE'LL BE THERE FOR YOU

Find all the video tutorials you need online.

YOU'RE GOING TO FEEL GOOD

Nothing will make you happier than holding your finished project.

RECIPE FOR SUCCESS

1

GET YOUR TOOLS READY.

Everything you need to get making.

2

FAMILIARISE YOURSELF WITH THE TECHNIQUES.

Everything from the stitches used to the finishing touches for your project.

3

GET TO KNOW YOUR YARN.

Before you start your piece, play around with your new yarn to get used to it, and to check your tension.

4

WOOL SCHOOL

Pick up your needles & yarn and make the magic happen! For a little extra help, check out our Wool School at:

www.woolandthegang.com/t/how-to

5

#WOOLANDTHEGANG

When you're done - let the world know.

LET'S GET KNITTING

Tool kit

- 6 [7] 7 [9] balls of WATG's Shiny Happy Cotton
- 1 Joe Cardigan pattern
- 1 circular knitting needle: US10.5 / 6.5mm, 100cm (40") long
- 1 sewing needle
- 5 buttons

Sizes

(finished garment width across chest)

Small (49cm/19.5")

Medium (52cm/20.5")

Large (56cm/22")

Extra large (61cm/24")

The pattern includes directions for four sizes. When the instructions differ between sizes, information is given for the smallest size first, followed by the remaining sizes. (example: Small [**Medium**] Large [**X-Large**]).

Tension

To ensure your knitting has the same measurements as the pattern, it is a good idea to make a tension swatch before you start knitting your project. A tension swatch is a small sample of your knitting where you count the stitches and rows and check them against the tension given in the pattern. If you get MORE stitches/rows than the pattern's tension, it means your knitting is tighter. If you get FEWER stitches/rows than the pattern, your knitting is looser. Sometimes, it works to knit tighter or looser to compensate.

When you make your swatch, make sure it is large enough for you to measure 10 cm/4" without including the stitches/rows closest to the edges (as these often have a slightly different tension). When you're done swatching, simply unravel and re-use the yarn to start knitting your Joe Cardigan.

Moss stitch

10 cm/4" = 13 stitches

10 cm/4" = 20 rows

All knitting techniques can be found at the back of the pattern.

MEASUREMENTS

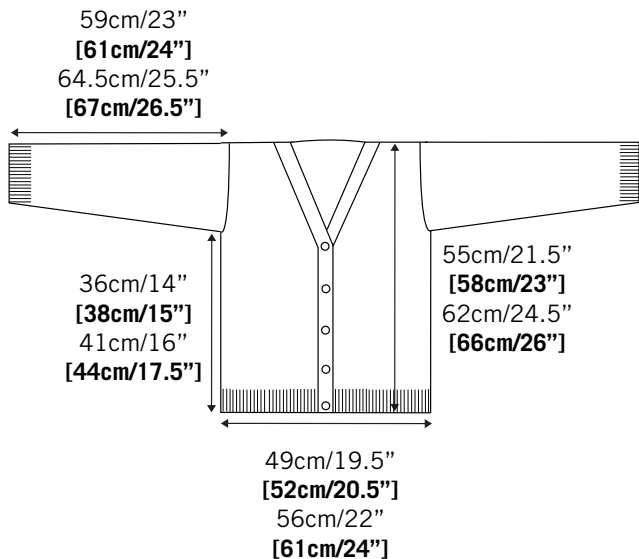

Pssst! Remember that you must not copy our patterns and sell, or even give them away for free, in accordance with copyright law.

HOW TO KNIT YOUR JOE CARDIGAN

BACK

- 1 Cast on 70 **[74]** 80 **[86]** stitches using the long-tail cast on technique.

- 2 Work in 1x1 rib stitch until your piece measures 6cm/2.5" from the cast on edge (approx. 9 rows). Make sure you work an uneven number of rows.

- 3 Decrease row: Work 4 **[8]** 4 **[10]** stitches in moss stitch. ★ Knit 2 stitches together, starting with a purl stitch, work 11 **[11]** 13 **[13]** stitches in moss stitch. ★ Repeat the section inside the stars a further 4 times. Knit the last stitch (65 **[69]** 75 **[81]** stitches.)

- 4 Work in moss stitch until your piece measures 36cm/14" **[38cm/15"]** 41cm/16" **[44cm/17.5"]** from the cast on edge (approx. a further 59 **[63]** 69 **[75]** rows). Make sure you work an uneven number of rows. (The yarn tail from your cast on should NOT be on the side edge directly below the tip of the needle.)

Next, you will shape the armholes.

- 5 Decrease row: Cast off 4 stitches, work in moss stitch to the end of the row. (61 **[65]** 71 **[77]** stitches.)

- 6 Repeat step 5. (57 **[61]** 67 **[73]** stitches.)

- 7** Decrease row: Knit 1 stitch, knit 2 stitches together, work in moss stitch until you have 3 stitches left of the row, knit 2 stitches together, knit the last stitch. (55 **[59]** 65 **[71]** stitches.)
-
- 8** Knit 2 stitches, work in moss stitch until you have 2 stitches left of the row, knit the last 2 stitches.
-
- 9** Decrease row: Knit 1 stitch, purl 2 stitches together, work in moss stitch until you have 3 stitches left of the row, purl 2 stitches together, knit the last stitch. (53 **[57]** 63 **[69]** stitches.)
-
- 10** Work 1 row in moss stitch.
-
- 11** Repeat steps 7 to 10 once more. (49 **[53]** 59 **[65]** stitches.)
-
- 12** Work in moss stitch until your piece measures 55cm/21.5" **[58cm/23"]** 62cm/24.5" **[66cm/26"]** from the cast on edge (approx. a further 28 **[30]** 32 **[34]** rows).
-
- 13** Cast off.

LEFT FRONT

- 1 Cast on 36 **[38]** 40 **[44]** stitches using the long-tail cast on technique.

- 2 Work in 1x1 rib stitch until your piece measures 6cm/2.5" from the cast on edge (approx. 9 rows). Make sure you work an uneven number of rows.

- 3 Decrease row: Work 8 **[4]** 6 **[4]** stitches in moss stitch. ★ Knit 2 stitches together, starting with a purl stitch, work 7 **[9]** 9 **[11]** stitches in moss stitch. ★ Repeat the section inside the stars twice more. Knit the last stitch. (33 **[35]** 37 **[41]** stitches.)

- 4 Work in moss stitch until your piece measures 33cm/13" **[34cm/13.5"]** 37cm/14.5" **[40cm/15.5"]** from the cast on edge (approx. a further 53 **[55]** 61 **[67]** rows). Make sure you work an uneven number of rows.

Next, you will start shaping the neck.

- 5 Decrease row: Work in moss stitch until you have 3 stitches left of your row, knit 2 stitches together, knit the last stitch. (32 **[34]** 36 **[40]** stitches.)

- 6 Knit 2 stitches, work in moss stitch to the end of the row.

- 7 Work in moss stitch until you have 2 stitches left of your row, knit the last 2 stitches.

8 Repeat step 6.

9 Decrease row: Work in moss stitch until you have 3 stitches left of your row, purl 2 stitches together, knit the last stitch. (31 **[33]** 35 **[39]** stitches.)

10 Work 1 row in moss stitch.

11 Decrease row: Work in moss stitch until you have 3 stitches left of your row, knit 2 stitches together, knit the last stitch. (30 **[32]** 34 **[38]** stitches.)

12 Knit 2 stitches, work in moss stitch to the end of the row.

Next, you will start shaping the armhole, whilst continuing to shape the neck edge.

13 Decrease row: Cast off 4 stitches, work in moss stitch until you have 3 stitches left of your row, purl 2 stitches together, knit the last stitch. (25 **[27]** 29 **[33]** stitches.)

14 Work 1 row in moss stitch.

15 Decrease row: Knit 1 stitch, knit 2 stitches together, work in moss stitch until you have 3 stitches left of the row, knit 2 stitches together, knit the last stitch. (23 **[25]** 27 **[31]** stitches.)

16 Knit 2 stitches, work in moss stitch until you have 2 stitches left of the row, knit the last 2 stitches.

- 17** Decrease row: Knit 1 stitch, purl 2 stitches together, work in moss stitch until you have 3 stitches left of the row, purl 2 stitches together, knit the last stitch. (21 **[23]** 25 **[29]** stitches.)
-
- 18** Work 1 row in moss stitch.
-
- 19** Repeat steps 15 to 18 once more. (17 **[19]** 21 **[25]** stitches.)
-
- 20** Decrease row: Work in moss stitch until you have 3 stitches left of the row, knit 2 stitches together, knit the last stitch. (16 **[18]** 20 **[24]** stitches.)
-
- 21** Knit 2 stitches, work in moss stitch to the end of the row.
-
- 22** Decrease row: Work in moss stitch until you have 3 stitches left of the row, purl 2 stitches together, knit the last stitch. (15 **[17]** 19 **[23]** stitches.)
-
- 23** Work 3 **[1]** 1 **[1]** row(s) in moss stitch.
-
- 24** Repeat steps 20 to 23 a further 0 **[0]** 1 **[5]** time(s). (15 **[17]** 17 **[13]** stitches.)
-
- 25** Decrease row: Work in moss stitch until you have 3 stitches left of the row, knit 2 stitches together, knit the last stitch. (14 **[16]** 16 **[12]** stitches.)
-
- 26** Knit 2 stitches, work in moss stitch to the end of the row.
-

- 27** Work in moss stitch until you have 2 stitches left of your row, knit the last 2 stitches.
-
- 28** Repeat step 26.
-
- 29** Decrease row: Work in moss stitch until you have 3 stitches left of the row, purl 2 stitches together, knit the last stitch. (13 **[15]** 15 **[11]** stitches.)
-
- 30** Work 5 **[3]** 3 **[3]** rows in moss stitch.
-
- 31** Repeat steps 25 to 30 a further 1 [2] **2** [0] time(s). (11
-
- 32** Work 0 **[1]** 0 **[1]** row(s) in moss stitch.
-
- 33** Cast off.
-

RIGHT FRONT

- 1 Repeat steps 1 to 4 as given for the left front.

Next, you will shape the neck.

- 2 Decrease row: Knit 1 stitch, knit 2 stitches together, work in moss stitch to the end of the row. (32 **[34]** 36 **[40]** stitches.)
-

- 3 Work in moss stitch until you have 2 stitches left of the row, knit the last 2 stitches.
-

- 4 Knit 2 stitches, work in moss stitch to the end of the row.
-

- 5 Repeat step 3.
-

- 6 Decrease row: Knit 1 stitch, purl 2 stitches together, work in moss stitch to the end of the row. (31 **[33]** 35 **[39]** stitches.)
-

- 7 Work 1 row in moss stitch.
-

- 8 Repeat steps 3 and 4 once more. (30 **[32]** 34 **[38]** stitches.)

Next, you will start shaping the armhole, whilst continuing to shape the neck edge.

- 9 Decrease row: Knit 1 stitch, purl 2 stitches together,
-

work in moss stitch to the end of the row. (29 **[31]** 33 **[37]** stitches.)

10 Decrease row: Cast off 4 stitches, work in moss stitch to the end of the row. (25 **[27]** 29 **[33]** stitches.)

11 Decrease row: Knit 1 stitch, knit 2 stitches together, work in moss stitch until you have 3 stitches left of the row, knit 2 stitches together, knit the last stitch. (23 **[25]** 27 **[31]** stitches.)

12 Knit 2 stitches, work in moss stitch until you have 2 stitches left of the row, knit the last 2 stitches.

13 Decrease row: Knit 1 stitch, purl 2 stitches together, work in moss stitch until you have 3 stitches left of the row, purl 2 stitches together, knit the last stitch. (21 **[23]** 25 **[29]** stitches.)

14 Work 1 row in moss stitch.

15 Repeat steps 11 to 14 once more. (17 **[19]** 21 **[25]** stitches.)

16 Decrease row: Knit 1 stitch, knit 2 stitches together, work in moss stitch to the end of the row. (16 **[18]** 20 **[24]** stitches.)

17 Work in moss stitch until you have 2 stitches left of the row, knit the last 2 stitches.

- 18** Decrease row: Knit 1 stitch, purl 2 stitches together, work in moss stitch to the end of the row. (15 **[17]** 19 **[23]** stitches.)
-
- 19** Work 3 **[1]** 1 **[1]** row(s) in moss stitch.
-
- 20** Repeat steps 16 to 19 a further 0 **[0]** 1 **[5]** time(s). (15 **[17]** 17 **[13]** stitches.)
-
- 21** Decrease row: Knit 1 stitch, knit 2 stitches together, work in moss stitch to the end of the row. (14 **[16]** 16 **[12]** stitches.)
- 22** Work in moss stitch until you have 2 stitches left of the row, knit the last 2 stitches.
-
- 23** Knit 2 stitches, work in moss stitch to the end of the row.
-
- 24** Repeat step 22.
-
- 25** Decrease row: Knit 1 stitch, purl 2 stitches together, work in moss stitch to the end of the row. (13 **[15]** 15 **[11]** stitches.)
-
- 26** Work 5 **[3]** 3 **[3]** rows in moss stitch.
-
- 27** Repeat steps 21 to 26 a further 1 **[2]** 2 **[0]** times. (11 stitches.)
-
- 28** Work 0 **[1]** 0 **[1]** row(s) in moss stitch.
-

29 Cast off.

SLEEVE

Follow the instructions twice to make the two sleeves.

- 1** Cast on 28 **[30]** 30 **[30]** stitches using the long-tail cast on technique.

- 2** Work in 1x1 rib stitch until your piece measures 6cm/2.5" from the cast on edge (approx. 9 rows).

- 3** Decrease row: Work 12 **[14]** 14 **[14]** stitches in moss stitch, knit 2 stitches together, work in moss stitch to the end of the row. (27 **[29]** 29 **[29]** stitches.)

- 4** Work 3 **[1]** 1 **[3]** row(s) in moss stitch.

- 5** Increase row: Knit 1 stitch, increase 1 stitch, work in moss stitch until you have 1 stitch left of your row, increase 1 stitch, knit the last stitch. (29 **[31]** 31 **[31]** stitches.)

- 6** Knit 2 stitches, work in moss stitch until you have 2 stitches left of the row, knit the last 2 stitches.

- 7** Repeat step 6 a further 8 **[10]** 8 **[4]** times.

- 8** Increase row: Knit 1 stitch, increase 1 stitch, work in moss stitch until you have 1 stitch left of your row, increase 1 stitch, knit the last stitch. (31 **[33]** 33 **[33]**)

stitches.)

9 Work 11 [**11**] **9** [**7**] rows in moss stitch.

10 Repeat steps 5 to 9 a further 2 [**2**] 3 [**5**] times. (39 [**41**] 45 [**53**] stitches.)

11 Repeat steps 5 to 7 once more. (41 [**43**] 47 [**55**] stitches.)

Next, you will shape the sleeve cap.

12 Decrease row: Cast off 4 stitches, work in moss stitch to the end of the row. (37 [**39**] 43 [**51**] stitches.)

13 Repeat step 12. (33 [**35**] 39 [**47**] stitches.)

14 Decrease row: Knit 1 stitch, knit 2 stitches together, work in moss stitch until you have 3 stitches left of the row, knit 2 stitches together, knit the last stitch. (31 [**33**] 37 [**45**] stitches.)

15 Knit 2 stitches, work in moss stitch until you have 2 stitches left of the row, knit the last 2 stitches.

16 Decrease row: Knit 1 stitch, purl 2 stitches together, work in moss stitch until you have 3 stitches left of the row, purl 2 stitches together, knit the last stitch. (29 [**31**] 35 [**43**] stitches.)

17 Work 1 row in moss stitch.

- 18** Repeat steps 14 to 17 a further 4 times. (13 **[15]** 19 **[27]** stitches.)
-
- 19** Decrease row: Knit 1 stitch, knit 2 stitches together, work in moss stitch until you have 3 stitches left of the row, knit 2 stitches together, knit the last stitch. (11 **[13]** 17 **[25]** stitches.)
-
- 20** Decrease row: Knit 1 stitch, knit 2 stitches together, work in moss stitch until you have 3 stitches left of the row, knit 2 stitches together, knit the last stitch. (9 **[11]** 15 **[23]** stitches.)
-
- 21** Repeat steps 19 and 20 a further 0 [0] **1** [2] time(s). (9 **[11]** 11 **[15]** stitches.)
-
- 22** Cast off.

ASSEMBLY AND FINISHING

- 1 Place your two fronts on top of the back piece, with the wrong sides touching. Use the horizontal invisible seam technique to sew the shoulder seams.

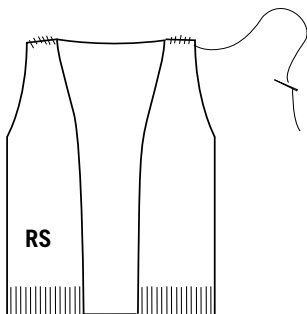

Front edging

- 1 With the right side of the fabric facing, and working from right to left, pick up and knit a total of 238 **[250]** 268 **[294]** stitches along the open edges of your cardigan. Start at the bottom edge of the left front, and distribute the stitches as follows:

Left front - straight edge: 60 **[62]** 66 **[72]** stitches

Left front - sloped edge: 38 **[40]** 42 **[44]** stitches

Back neck edge: 42 **[46]** 52 **[62]** stitches

Right front - sloped edge: 38 **[40]** 42 **[44]** stitches

Right front - straight edge: 60 **[62]** 66 **[72]** stitches

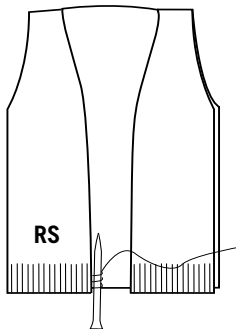

- 2** Work 2 rows in 1x1 rib stitch.

Next, you will create the button holes.

-
- 3** Work 178 [**190**] 202 [**222**] stitches in 1x1 rib stitch.

★Cast off 2 stitches, work 12 [**12**] 14 [**16**] stitches in 1x1 rib stitch.★

Repeat the section inside the stars twice more. Cast off 2 stitches, work 8 stitches in 1x1 rib stitch. Cast off 2 stitches, work 6 stitches in 1x1 rib stitch.

-
- 4** Work 6 stitches in 1x1 rib stitch, cast on 2 stitches using the cable cast on technique. Work 8 stitches in 1x1 rib stitch, cast on 2 stitches using the cable cast on technique.

★Work 12 [**12**] 14 [**16**] stitches in 1x1 rib stitch, cast

on 2 stitches using the cable cast on technique.★

Repeat the section inside the stars twice more.

5 Work 2 rows in 1x1 rib stitch.

6 Cast off.

7 Lay your cardigan flat so the front edges overlap, with the button hole edge on top. Mark the placement of the buttons and sew them onto the button band, securing each one with several stitches.

SLEEVES AND SIDE SEAMS

1 With the right sides facing, line your sleeves up with the body piece, so that the centre of the cast off edge on the sleeve meets the shoulder seam. The corners of the sleeves should line up with the start of the armhole shaping on the body of the cardigan.

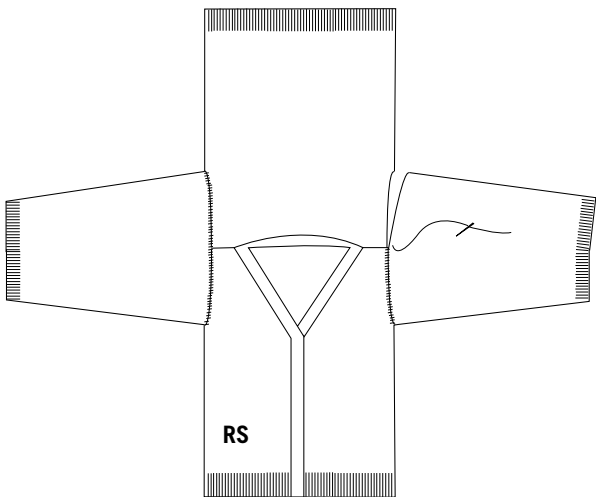

- 2 Now fold your cardigan in half along the shoulders and sleeves, with the right side facing out. Starting at the bottom edge, use the vertical invisible seam technique to sew the side edges together all the way up to the underarm. Then start again at the sleeve hem, and sew the sleeve edges in the same way. Repeat for the other side.

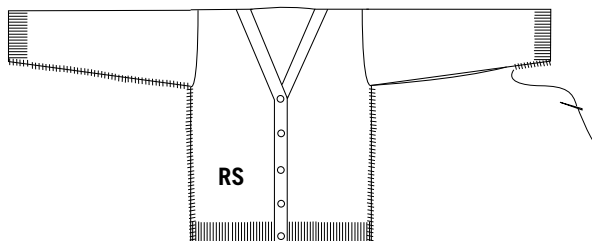

- 3** Weave in the loose ends.

KNITTING TECHNIQUES

Long-tail cast on

This creates a nice elastic edge, suitable for stretchy items like ribbed edges. To make sure that the edge isn't too tight, you can cast on over two knitting needles held together.

1. Start by making a slipknot - the 'yarn tail' needs to be quite long for this cast on, hence the name! Place the slipknot on your knitting needle, and hold the needle in your right hand, with the yarn hanging straight down.
2. Now insert the thumb and index finger of your left hand between the two strands of yarn hanging from the needle, and then close your ring finger and little finger around the yarn to trap it.

Stretch out your thumb and index finger as far from each other as possible, stretching the yarn taut.

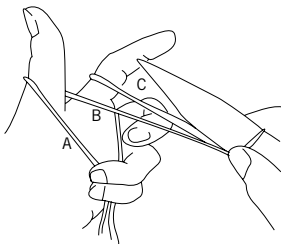

3. You will be using three separate strands of yarn:

A: the strand which sits closest to you, in front of the thumb
B: the strand that goes from the thumb to the slipknot on the needle

C: the strand that goes from the needle to your index finger

4. Place the needle in front of A, then bring it under A and let it come up between A and B.

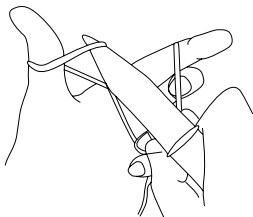

5. Now bring the needle over and behind C, and scoop the yarn (C) up with the tip of your needle.

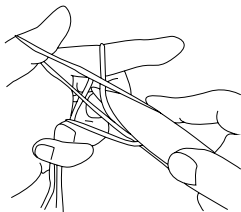

6. Bring the needle tip with the yarn back between A and B (the same way you came before), so that it ends up in front of A. Now pull your thumb out from the yarn that's looped around it. Tug on the yarn to tighten up the new loop on your

knitting needle, then insert your thumb again between the two yarn strands hanging down from the newly formed loop on your needle.

7. Repeat steps 4-6 to continue casting on stitches.

Using circular needles for knitting flat pieces

Circular needles aren't just for knitting in the round - they are also great for knitting flat pieces, if you have more stitches than you can fit on standard straight knitting needles. As you knit, the stitches will move across from the end of the circular needle in your left hand towards the other end in your right hand - the stitches you have knitted will hang between the two needle ends. After knitting your row, simply turn the long needle around so the end of your work with the tail of yarn you are knitting with is in your left hand ready to start a new row.

1 x 1 Rib stitch

Working over an even number of stitches, repeat the following row:

★ Knit 1 stitch, purl 1 stitch. ★ Repeat the section inside the stars to the end of the row.

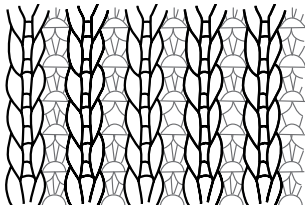

Moss stitch

A simple stitch pattern where you alternate between knit and purl stitches on every row. For an uneven number of stitches, repeat the following row:

Row 1: ★Knit 1 stitch, purl 1 stitch.★ Repeat the section inside the stars until you have one stitch left of your row. Knit the last stitch.

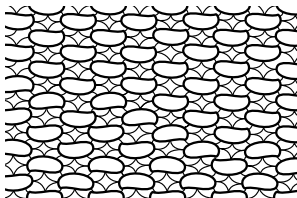

Decreasing

Instead of knitting only one stitch at a time, knit two stitches together. Insert the front of your right needle through the first two stitches on the left needle, then knit them together as a single stitch. To purl 2 stitches together, insert the right needle through the next two stitches and purl them together as if they were a single stitch.

Increasing

Make a new stitch by inserting the left needle from front to back under the strand of yarn between the last stitch worked and the next stitch to be worked, and lifting this loop onto the needle. Now insert the right needle into this loop from right to left, then wrap the yarn and pull through as for a knit stitch.

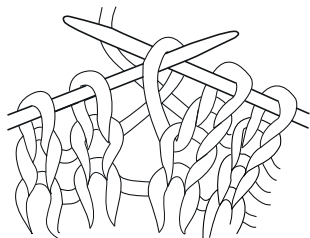

Adding a new ball of yarn

When your ball of yarn runs out, tie a loose knot on to the tail with the new ball of yarn and slide it up to the needle. Tighten the knot. Continue knitting with the new yarn.

Casting off

To complete your project, you need to cast off your last row of stitches in order to make an edge that won't unravel. For your final row, knit the first two stitches. Using the tip of the left needle, lift the first stitch up and over the second stitch and then slip it off the right needle. Now you have only one stitch on your right needle. Knit the next stitch from the left needle, then lift the previous stitch over it and off the needle as before. Do this with each stitch until there are no stitches on the left needle and just one stitch on the right needle. Cut the yarn, leaving a 15 cm/6" end. Pull on the last loop until the end pops through - you've now secured the last stitch.

FINISHING TECHNIQUES

Horizontal invisible seam technique

This technique is used for sewing together horizontal edges (like cast on and cast off edges). Align the two edges so that they are lined up stitch by stitch. Insert the sewing needle under a V stitch and then under the corresponding V stitch on the other side. Continue in this way until the seam is complete.

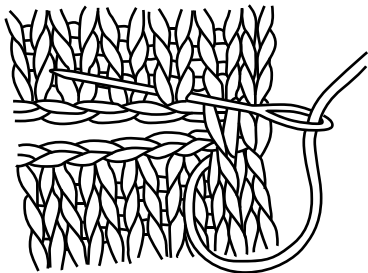

Perpendicular invisible seam

Align the pieces to be seamed side-by-side with the two pieces at right angles to each other. Insert the sewing needle through the vertical 'V' on the piece where you are joining a cast on or cast off edge, and then through the horizontal bar on the piece where you are joining a side edge. Repeat this and pull the yarn so that the two pieces join together. You will see that you have more rows to sew than stitches. To compensate for this, insert the needle under two horizontal bars on the side edge at the same time every third stitch.

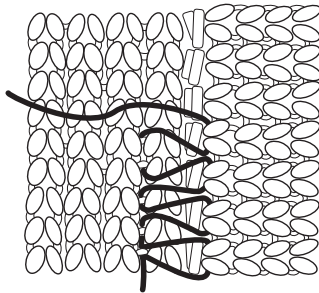

Vertical invisible seam

This technique is used to join two side edges. Line up the edges side by side with the right side of the fabric facing up. Insert your sewing needle under the first horizontal bar between the first two stitches on the edge you want to join. Pull the yarn through and insert the needle through the opposite horizontal bar on the other piece. Sew back and forth through the horizontal bars along the edge. To tighten the stitches, pull the yarn gently - and they will disappear.

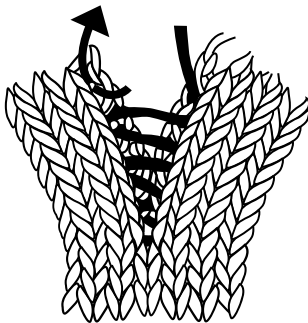

Weaving in the ends

Weave the ends of your yarn into your knitting to finish it off and stop it from unravelling. Thread the tail onto the sewing needle. Weave the yarn along the edge of your knitting as shown in the diagram. Weave in approximately 10 cm/4", then cut the tail.

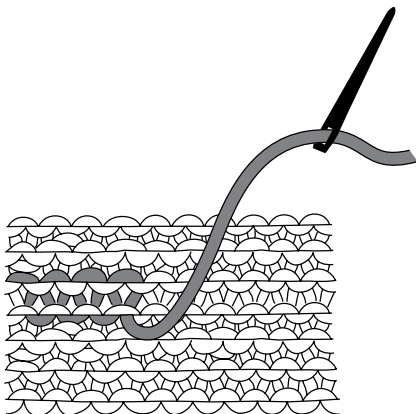

MAKING MEMOIRS

STARTED ON

FINISHED ON

WHERE I MADE IT

-

-

-

MADE FOR

Me

COLOUR COMBO

THIS PROJECT WAS

() easy peasy () nice () challenging () hardcore

I FEEL    

OTHER THOUGHTS

.....



Wool and the Gang



@woolandthegang



@woolandthegang



WATGsnaps



Wool and the Gang



woolandtheganghq

YOUR PROJECT DESERVES SOME SEXY YARN



CRAZY SEXY WOOL
100% Peruvian Wool



SUGAR BABY ALPACA
100% Baby Alpaca



WOOL ME TENDER
100% Peruvian Wool



JERSEY BE GOOD
98% Cotton
2% Elastane



MIXTAPE YARN
80% Cotton
20% Polyester



BILLIE JEAN
100% Upcycled Denim



SHINY HAPPY COTTON
100% Peruvian
Pima Cotton



WOOLY BULLY ALPACA
80% Superfine Alpaca
20% Merino Wool



SHEEPACA YARN
50% Baby Alpaca
50% Merino Wool



TAKE CARE MOHAIR
78% Kid Mohair
13% Wool / 9% Polyamide



FEELING GOOD
70% Baby Alpaca
7% Merino / 23% Nylon

**WOOL
AND THE
GANG**

V827078188

