

TREKKER

LUXURY DECKING & CLADDING

TREKKER WPC COMPOSITE DECKING INSTALLATION GUIDE

These guidelines are designed to complement the current British Standards or the relevant standards in the country of installation.

Safety must be paramount on every installation. All electrical equipment must be PAT tested and labelled and all cutting tools such as jigsaws, circular and bench saws must have guards fitted and cutting must be carried out on a suitable bench. You must also wear suitable work wear and remove or make safe any loose items such as jewellery. Safety is your responsibility.

The installer must be suitably trained and knowledgeable with decking installations.

Trekker Composite Decking must be fixed to joists/bearers. The following topics are covered by this document, for further information or for advice on any subject not covered here, please contact Trekker Global:

T: 01483 310800

E: info@trekkerglobal.com

Substrate Requirements

Sub-Deck Preparation

Installation

Care and Maintenance

N.B The final responsibility for the installation lies with the installer. It is the duty of the installer to inspect materials prior to installation and notify Trekker Global of any potential material defects prior to installation. Installed materials are deemed to have been accepted.

Please be aware that it may be necessary to trim each decking plank during the installation

Trekker Global Limited

11a Midleton Industrial Estate,
Guildford, GU2 8XW

info@trekkerglobal.com
www.trekkerglobal.com

01483 310800

TREKKER

LUXURY DECKING & CLADDING

INSTALLATION REQUIREMENTS

The performance and longevity of any decking material is dependent on the correct installation methods.

Each 1m² of installed Trekker Decking requires a minimum of:

- 7.24 lin. m of Trekker Planks / 5.28 lin. m for Trekker Mixed-Width
- 3.5-4.5 lin. m of Joists (dependent on size and layout of deck)
- 25 fixing clips / 17 aluminium clips for Trekker Mixed Width

Substrate & Bearers

Where the decking is to be fitted to a structural cementitious base, Trekker decking joists or Class 4 timber joists may be used. These must be of a minimum 30mm thickness and 50mm face width, spaced at 300mm centres and fixed to the substrate every 500mm along their length with nylon hammer-fixings.

For diagonal installations of Trekker decking, joist centres should be reduced to 250mm.

Joists should be doubled at the short-end joints of planks as per the diagram. Spacing of 15mm should be left at the point where joists meet to allow water run-off beneath the deck. Where a single joist length spans the area to be installed, notches can be made to the underside of the joist to allow run-off.

Where a structural joist is required when installing to pedestals or cross-bearers, Class 4 timber joists of a suitable depth, aluminium joists and/or the Trekker Raised Deck System may be used. Consult the Trekker Raised Deck System installation instructions for further information.

Installation of Decking Materials

A successful TREKKER decking installation is dependent on 4 key factors:

- Correct spacing of the supporting joists/battens at no more than 300mm centres.
- A longitudinal slope of at least 1% to allow run-off and prevent standing water.
- Correct expansion allowance of 6-8mm at the short end joints between planks and 10mm at the perimeter of the installed deck.
- WPC joists may only be used when fixed to a structural base and not as part of a raised or elevated decking system.

The area should be assessed to ensure that the final cut is no less than 1/3 of the width of a plank. If the final cut will be too small, then the installation should also begin with a rip-cut. Standard woodworking router tools can be used to profile a groove to the side of the sawn plank so that the clip can be engaged. N.B. semi-solid constructions require planning of cuts to ensure that the appropriate structure of the plank can be machined accordingly.

When installing **Trekker stair nosings**, the nosing must be installed first as the start-point of the installation. The Trekker nosing is profiled to receive a standard clip and the installation should be planned to accommodate longitudinal (rip) cuts at the opposing junction. Face fixing of nosings is advised.

To face-fix nosings, use a plug cutter to allow for a hidden fixing. Over-drill the hole to receive the screw with a 7mm drill bit. Over-drill the recess to hide the screw head with a 9.5mm plug cutter bit to approx. half the thickness of the nosing. Use a pan-headed (domed) screw to fix the nosing to the bearers. Bond new plugs cut from a spare section of Trekker material with a PVC weld adhesive. Chisel off excess plug and sand as necessary with a fine grade paper.

Trekker Global Limited

11a Midleton Industrial Estate,
Guildford, GU2 8XW

info@trekkerglobal.com
www.trekkerglobal.com

01483 310800

TREKKER

LUXURY DECKING & CLADDING

Trekker clips can be cut down to form start/end clips by removing half of the clip mechanism. Stainless steel start clips are also available in the Trekker brochure. Clips should be fixed with the appropriate supplied screws at every joist, ensuring that the placement of the next board engages fully with the opposing side of the clip.

Where physical or face fixing of planks is necessary at mitred junctions or perimeter details, the decking must be over-drilled to allow for expansion around the fixing, this prevents splitting of the material. Drill the point of fixing with a 3mm bit into the support and then drill to the decking depth only with a 7mm bit before screw-fixing with the appropriate pan-headed screws. If these screw fixing must be hidden, please see use of plugs in nosing fixing instructions above.

Physical fixings may only ever be applied to one point of the plank. This can be at one end or at the centre of the plank, but the opposing points must be fixed with clips to allow longitudinal expansion. Screw fixing of the plank at multiple points can result in splitting of the material.

When installing the Trekker trim to a vertical finished edge, this must also be over-drilled to allow for expansion around the fixing. Drill the point of fixing with a 3mm bit into the support and then drill to the trim depth with a 7mm bit before screw-fixing with the appropriate pan-headed screws.

Where high surface temperatures are likely to occur due to transfer of heat from a large thermal mass (of concrete), timber joists or Trekker joists placed on EPDM rubber may be used to prevent the formation of a thermal bridge.

SUB-DECK INSTALLATION (TIMBER / TREKKER WPC BEARERS)

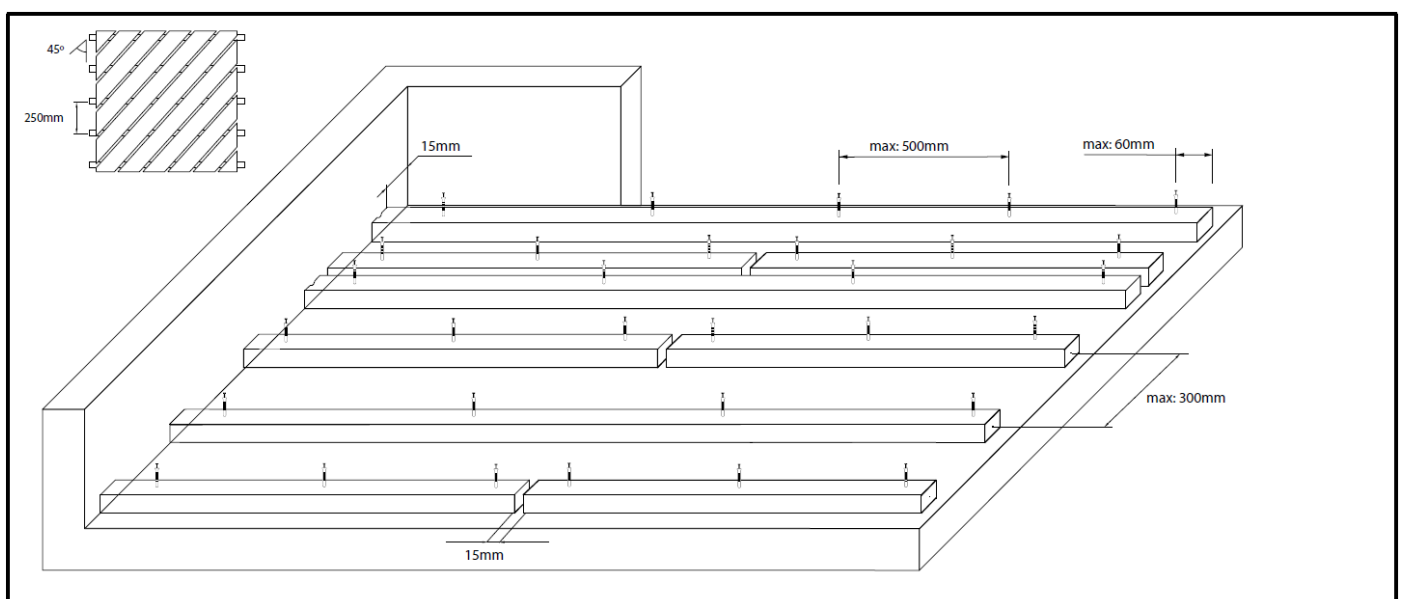
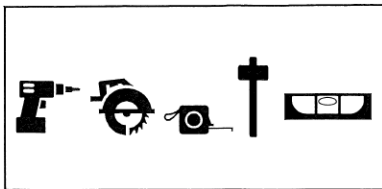

Trekker Global Limited

11a Midleton Industrial Estate,
Guildford, GU2 8XW

info@trekkerglobal.com
www.trekkerglobal.com

01483 310800

TREKKER

LUXURY DECKING & CLADDING

TREKKER WOOD GRAIN INSTALLATION

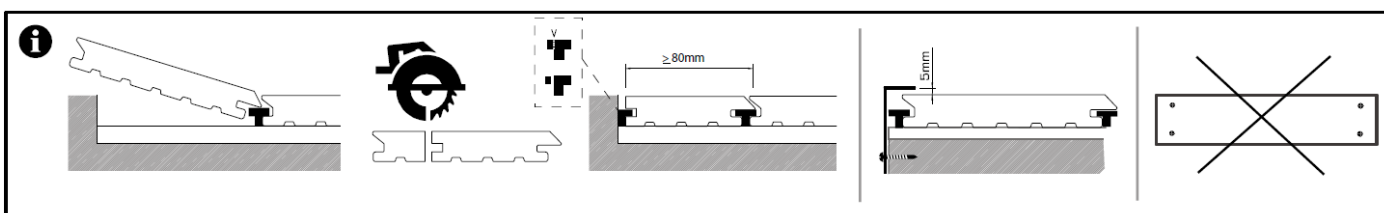
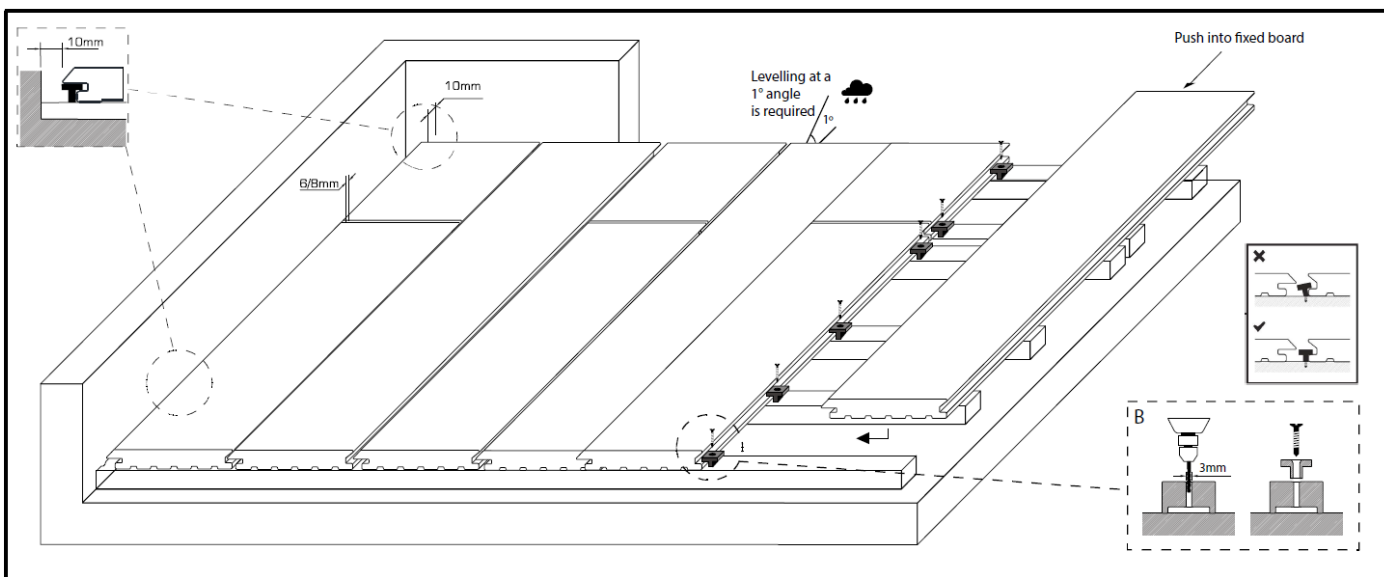
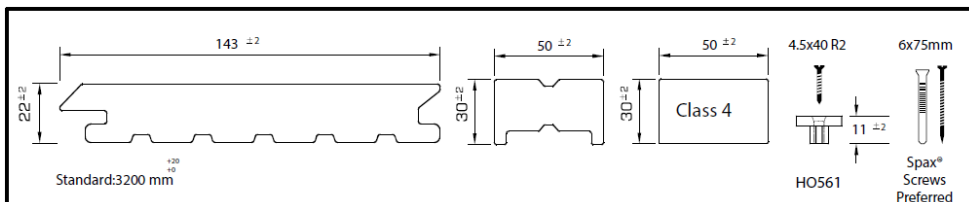

Trekker Global Limited

11a Midleton Industrial Estate,
Guildford, GU2 8XW

info@trekkerglobal.com
www.trekkerglobal.com

01483 310800

TREKKER

LUXURY DECKING & CLADDING

TREKKER FLUTED/GROOVED INSTALLATION

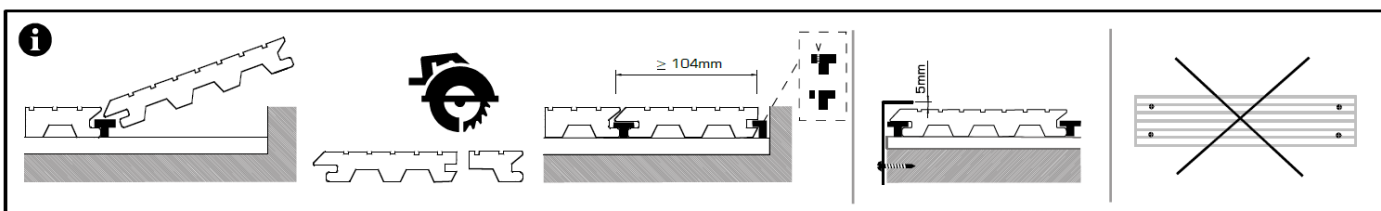
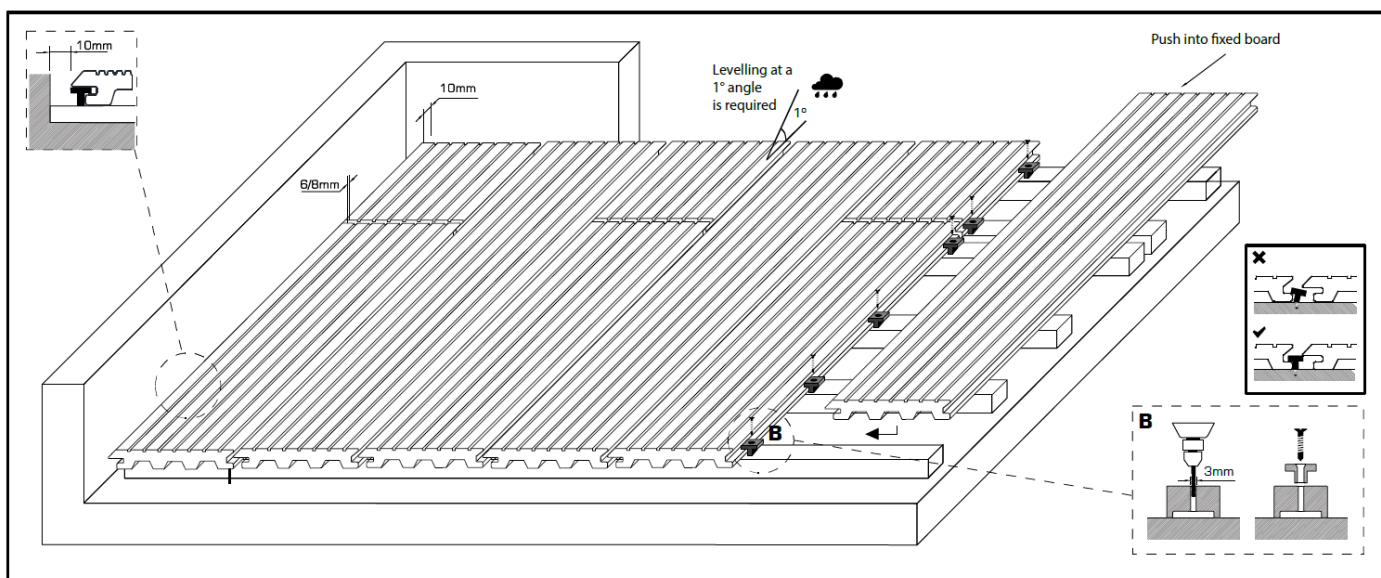
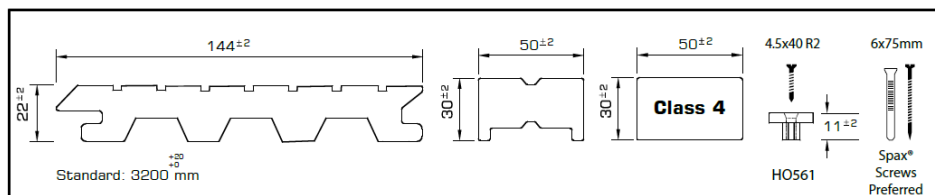

Trekker Global Limited

11a Midleton Industrial Estate,
Guildford, GU2 8XW

info@trekkerglobal.com
www.trekkerglobal.com

01483 310800

TREKKER

LUXURY DECKING & CLADDING

TREKKER MIXED-WIDTH INSTALLATION

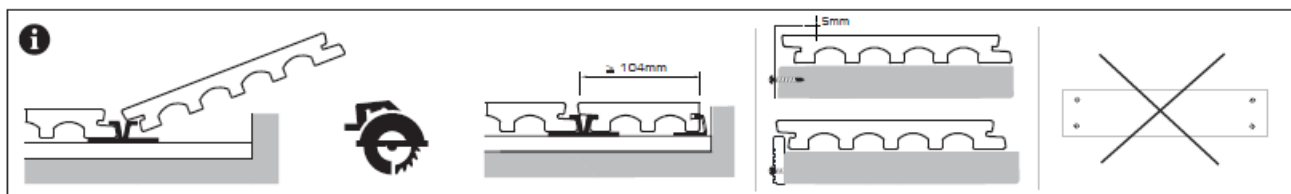
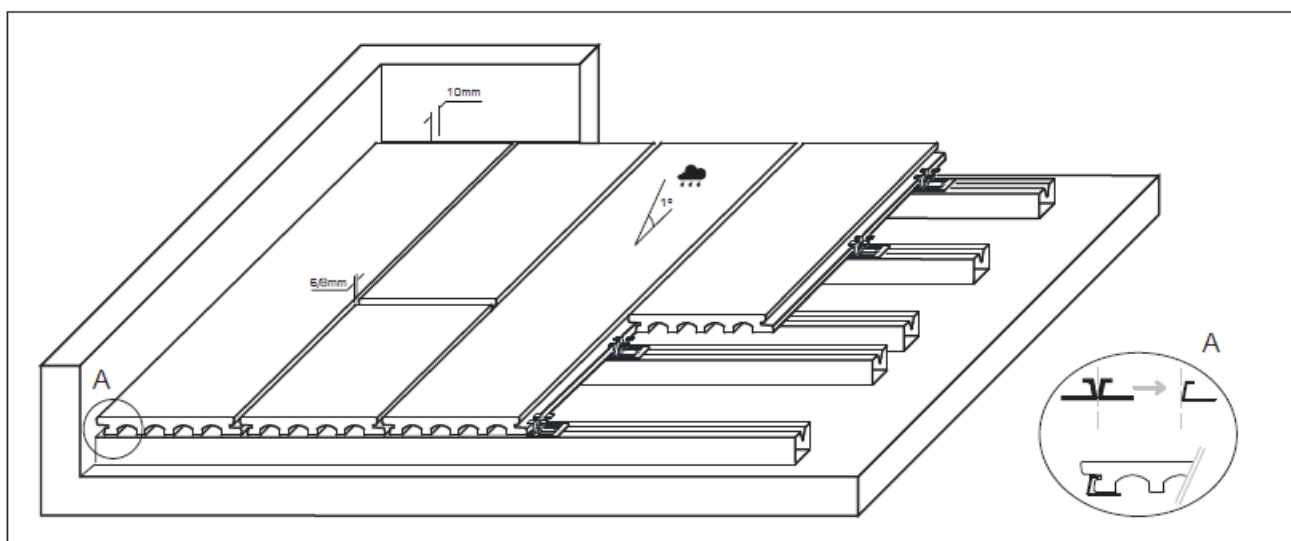
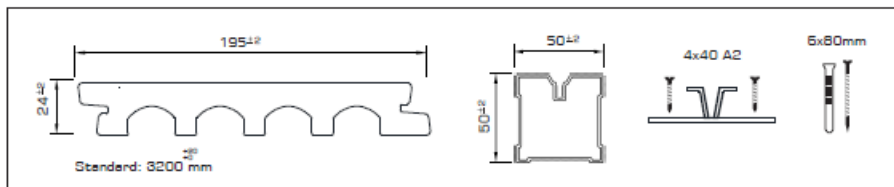

Trekker Global Limited

11a Midleton Industrial Estate,
Guildford, GU2 8XW

info@trekkerglobal.com
www.trekkerglobal.com

01483 310800

TREKKER

LUXURY DECKING & CLADDING

TREKKER FASCIA INSTALLATION

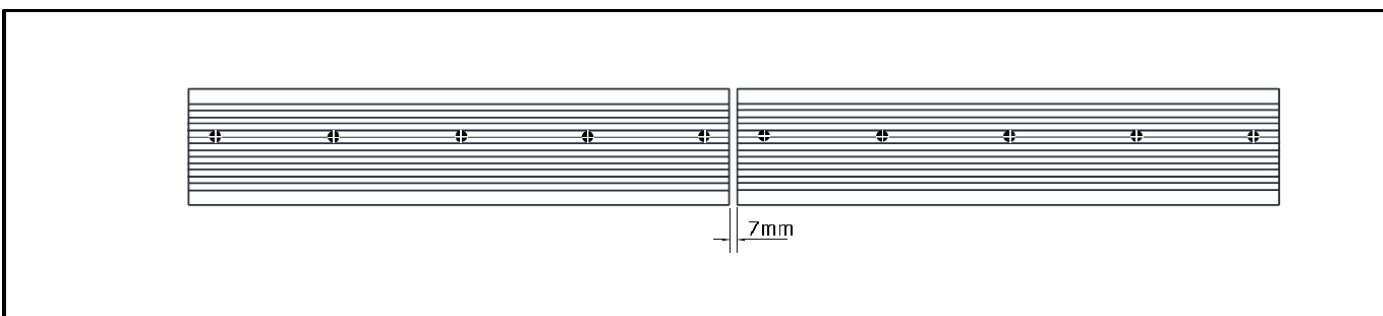
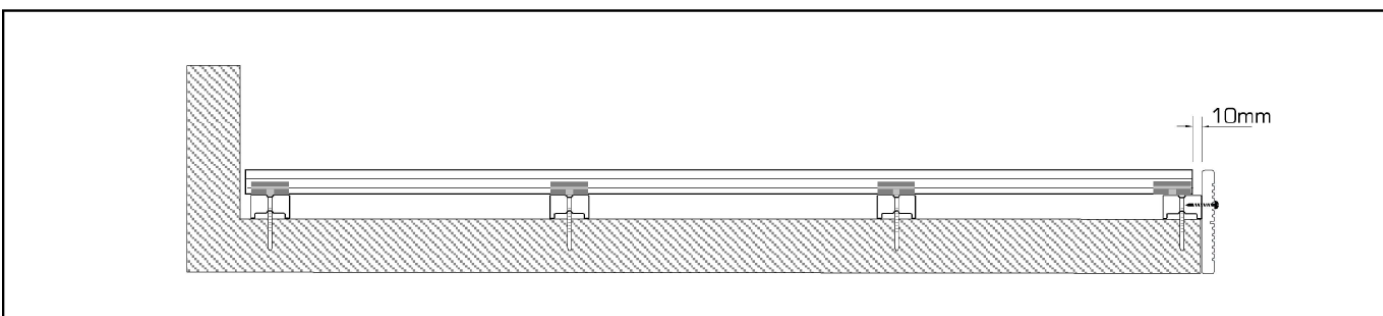
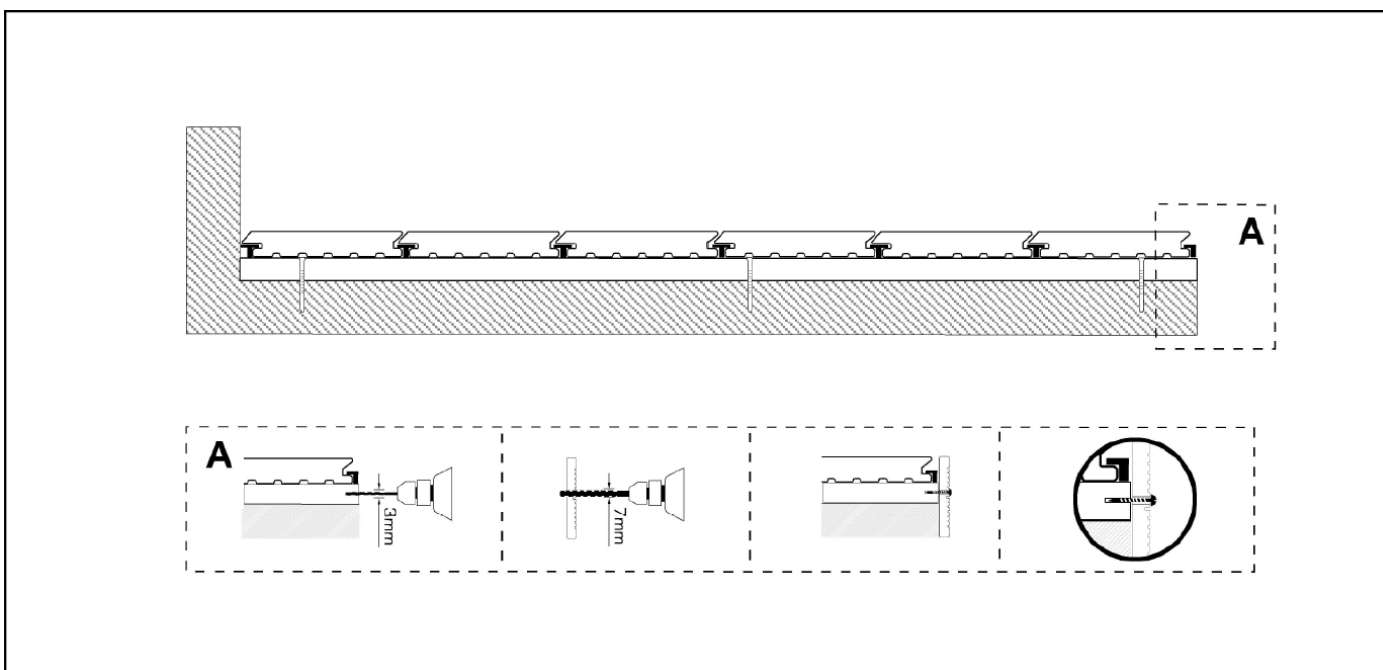
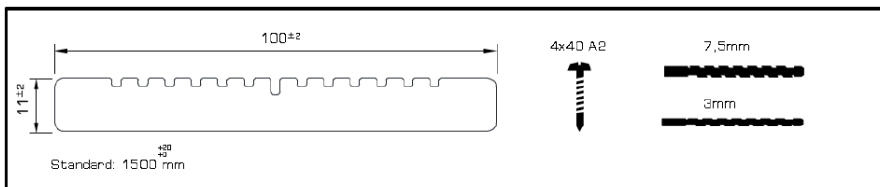

Trekker Global Limited

11a Midleton Industrial Estate,
Guildford, GU2 8XW

info@trekkerglobal.com
www.trekkerglobal.com

01483 310800

TREKKER

LUXURY DECKING & CLADDING

STAIR NOSING INSTALLATION

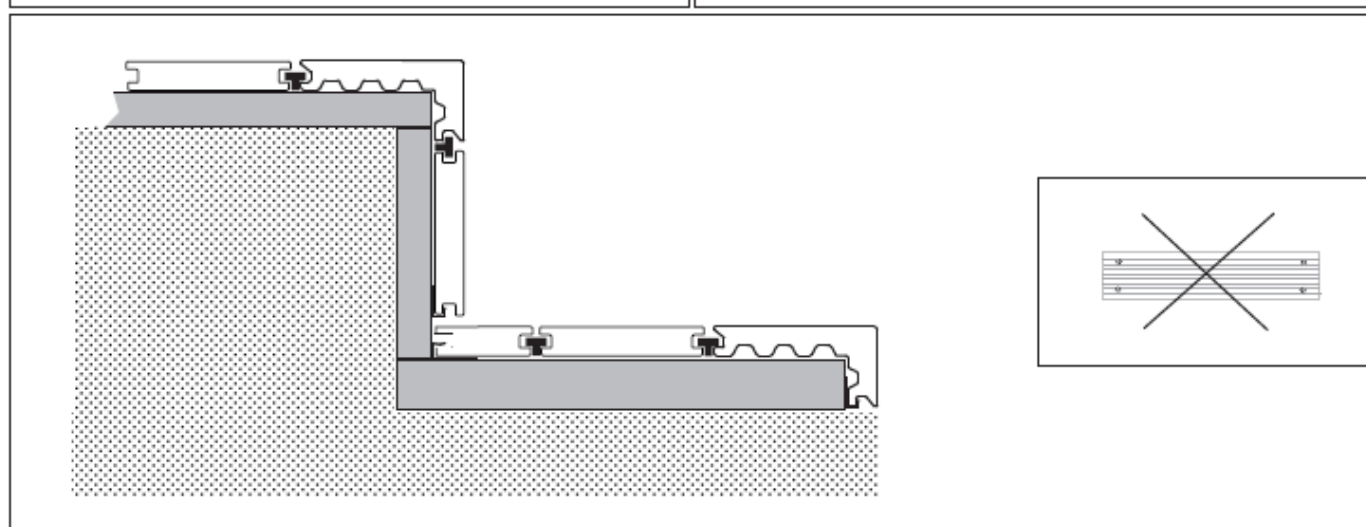
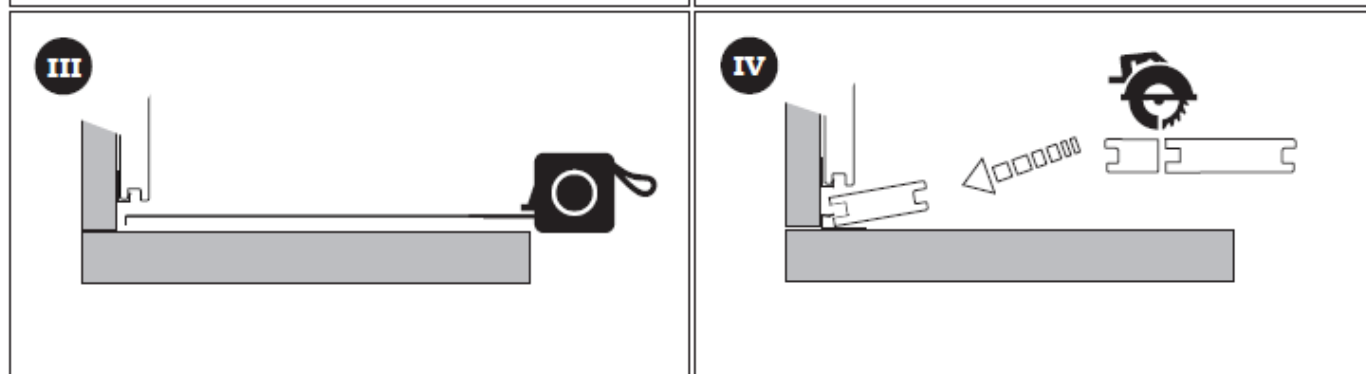
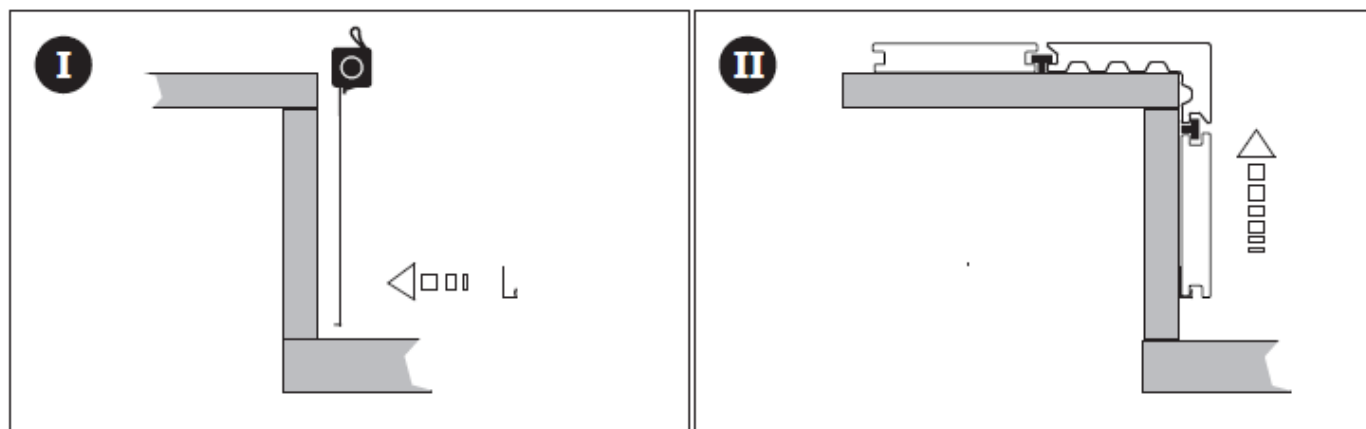
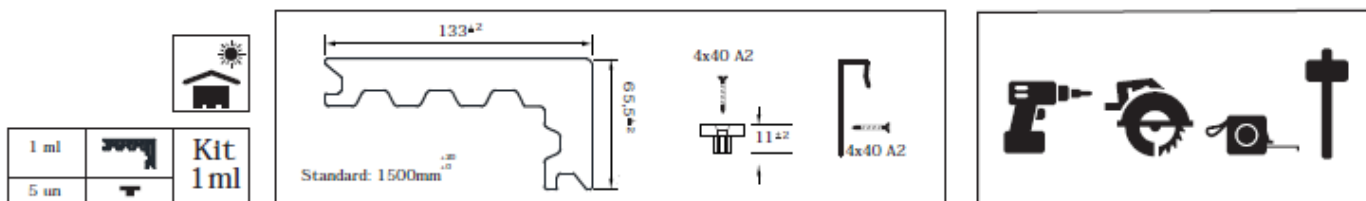

Trekker Global Limited

11a Midleton Industrial Estate,
Guildford, GU2 8XW

info@trekkerglobal.com
www.trekkerglobal.com

01483 310800

TREKKER

LUXURY DECKING & CLADDING

STAIR NOSING – HIDDEN FACE FIXING METHOD

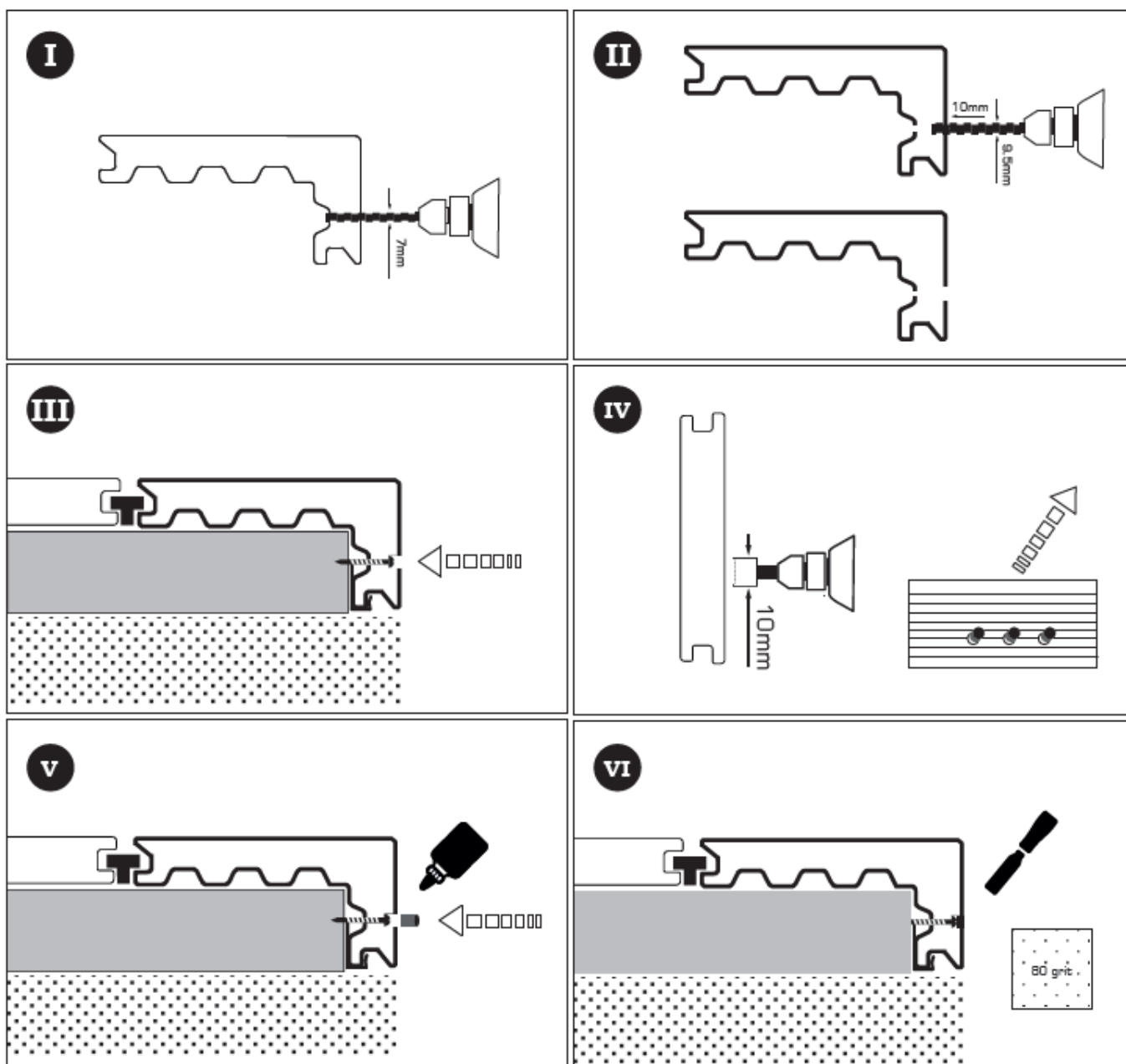
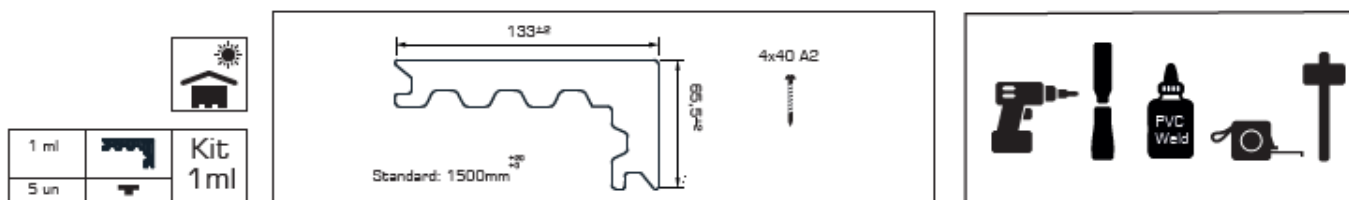

Trekker Global Limited

11a Midleton Industrial Estate,
Guildford, GU2 8XW

info@trekkerglobal.com
www.trekkerglobal.com

01483 310800

TREKKER

LUXURY DECKING & CLADDING

CARE & MAINTENANCE

A composite deck will expand under exposure to elevated temperatures. It may be necessary to periodically adjust the spacing of the deck, dependent on the installation area.

Expansion gaps should be kept clean to facilitate the flow of rainwater and water from washing.

In case of spillage of liquids, sauces or other substances that may foul the deck, they shall be removed immediately. If not, the deck can absorb these substances, and removing the stains will be harder.

If there is need to eliminate dirt, spots or scratches in the deck, you can use sandpaper. The sanded area will present a lighter shade, but with natural exposure, the colour should be uniform.

General cleaning of the deck should be undertaken with clean water. You can use a thick broom in order to clean the surface. Alternatively, you can use a pressure washer machine (water pressure should not exceed 6 bar) using a jet fan with the proper distance to the deck (so the water won't scratch the deck). The correct dilution of Trekker Maintenance Cleaner can be used for a more intensive clean.

Natural tonal change may occur in the deck in the first weeks (10 to 12 weeks) of exposure. This discoloration varies naturally with the UV light exposure of the product. In areas with less exposure, discoloration will naturally be lower. There should be no standing water on the deck after a period of rain. Standing water areas mean improper installation, which should be rectified.

Frequently check the substructure in order to ensure that it is unhindered for good water drainage. The deposit and stagnation of water in the base, causes the putrefaction of the base and of the elements installed there.

If food deposits are left on the deck surface for a prolonged period, there is inadequate drainage or consistently damp conditions in an area shaded under trees/by neighbouring buildings, then there is the potential for fungal growth.

For fungus to grow on the surface of Composite Decking it requires several elements. These include:

- Food; this can be anything from an accumulation of dirt, leaf mould or any organic material build-up.
- Shade; from trees, garden furniture or surrounding buildings, etc.
- Moisture; a lack of fall in the decking installation can lead to standing surface water for prolonged periods.

A combination of any of these elements can provide a habitat for fungal growth.

The solution to fungal growth is to use a fungicidal cleaner, such as 'Wet and Forget'. Start by thoroughly covering the area with Wet & Forget via spray application and leave to work. It should be noted that, while Wet & Forget will clear the decking mould/fungal growth and eradicate the fungal spores, it should not be treated as an alternative to a regular cleaning routine.

We don't recommend using a power/jet washer to try to remove growth because it may force spores deeper into the material.

©This information Sheet was written by Trekker Global, 11a Midleton Industrial Estate, Guildford, GU2 8XW.

At the time of writing and publication of this sheet, all information is specified correctly. The photographs used in this sheet are intended only as illustrations. No rights can be derived from them.