

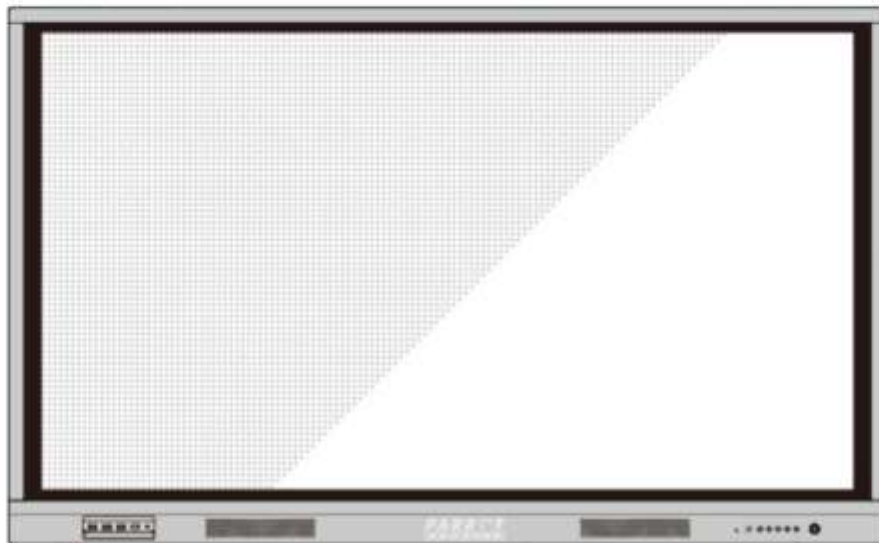

Interactive Touch Screen

User Manual

TWB-6519A | TWB-7519A | TWB-8619A



Tel: (RSA) 010 140 4900 / Email: sales@parrot.co.za
www.parrot.co.za

Contents

About This Document.....	v
Safety Instruction	vi
1 Overview	1
1.1 Parts	1
1.2 Ports	3
1.3 Remote Control.....	6
1.4 Temperature Control.....	7
2 Installation Guide.....	8
2.1 Safety Precautions.....	8
2.2 Installation Precautions	10
2.3 Installation.....	12
2.4 Installing the Internal PC (Optional).....	13
3 Getting Started.....	14
3.1 Power On.....	14
3.2 Power Off.....	15
3.3 Calibration.....	16
4 Operating the Touch Screen.....	19
4.1 Start Screen.....	19
4.2 Home	19
4.3 System Settings.....	23
4.3.1 Network Settings.....	23
4.3.2 Language and Input Method Settings.....	24
4.3.3 Storage	26
4.3.4 Applications	27
4.3.5 Whiteboard/Screenshot	27
4.3.6 Floating Bar	28
4.3.7 Smart Eye Protection.....	28
4.3.8 Date and Time Settings	29
4.3.9 Power ON/OFF Setting.....	31
4.3.10 Wallpaper Setting	33
4.3.11 Input/Output Setting.....	33
4.3.12 Security Setting.....	34
4.3.13 About	35

4.4 Built-in PC	35
4.5 Source	36
4.6 Whiteboard	37
4.6.1 Whiteboard Functions	39
4.6.2 Page Operations	48
4.6.3 Object Detection	49
4.7 Screen Sharing	51
4.8 File Management	51
4.8.1 File Viewer Page	51
4.8.2 File Preview	52
4.8.3 File Operation	53
4.8.4 File Search	54
4.8.5 File Filtering	54
4.8.6 New Folder	55
4.8.7 File Name	56
4.9 Apps	56
4.10 Automatically End Meeting	58
5 Quick Setting Menu	59
6 Serial Port Control	61
7 FAQs & Troubleshooting	66
8 Specifications	69

Thank you for choosing the Interactive Touch Screen.
Please use this document to get the most out of your screen.

This device complies with Part 15 of the FCC Rules. Operation is subject to the following two conditions: (1) This device may not cause harmful interference, and (2) this device must accept any interference received, including interference that may cause undesired operation.

NOTE 1: This device has been tested and found to comply with the limits for a Class B digital device, pursuant to Part 15 of the FCC Rules. These limits are designed to provide reasonable protection against harmful interference in a residential installation. This device generates, uses, and can radiate radio frequency energy and, if not installed and used in accordance with the instructions, may cause harmful interference to radio communications. However, there is no guarantee that interference will not occur in a particular installation. If this device does cause harmful interference to radio or television reception, which can be determined by turning the device off and on, the user is encouraged to try to correct the interference by one or more of the following measures:

- Reorient or relocate the receiving antenna.
- Increase the separation between the device and receiver.
- Connect the device into an outlet on a circuit different from that to which the receiver is connected.
- Consult the dealer or an experienced radio/TV technician for help.

NOTE 2: Any changes or modifications to this unit not expressly approved by the party responsible for compliance could void the user's authority to operate the device.





The symbol of the crossed out wheeled bin indicates this product should not be placed in municipal waste. Instead, you should dispose of waste device by handing it over to a designated collection point for the recycling of electrical and electronic device.



About This Document







This document describes multiple functions, instructions, and notes about the product.

Symbols are used in this document to indicate operations that need particular attention. The symbols are defined as follows:

 NOTE	Provide additional information to supplement operation in the main text.
 TIP	Provide tips for operation.
 CAUTION	Indicate a potentially hazardous situation that, if not avoided, could result in device damage, data loss, performance deterioration, or unanticipated results.
 WARNING	Indicate a hazard with risk that, if not avoided, could result in death or injury.

Safety Instruction

For your safety, please read the following instructions before you use the product. Serious injury or property damage may be caused by improper operations. Do not try to repair the product on your own.

 WARNING	
	<p>Disconnect the product from power supply immediately if major failures occur.</p> <p>Major failures include:</p> <ul style="list-style-type: none"> • Smoke, peculiar smell or abnormal sound is discharged from the product. • No image or sound is displayed, or the image error occurs. <p>In the preceding scenarios, do not continue to use the product. Disconnect power supply immediately and contact professional staff for troubleshooting.</p>
	<p>Do not drop liquid, metal or anything combustible into the product.</p> <ul style="list-style-type: none"> • If any liquid or metal is dropped into the product, power off the product and disconnect power supply, then contact professional staff for solutions. • Pay attention to children when they are close to the product. <p>Put the product on a stable surface.</p> <p>An unstable surface includes but not limited to an inclined plane, a shaky stand, desk or platform, which might cause turnover and damage.</p>
	<p>Do not open the cover or change the product on your own.</p> <p>High voltage components are installed in the product. When you open the cover, high voltage, electric shock, or other dangerous situations may occur.</p> <p>If inspection, adjustment, or maintenance is required, contact the local distributor for help.</p>
	<p>Use the specified power supply.</p> <ul style="list-style-type: none"> • To prevent the product from being damaged, do not use any types of power cables other than that provided with the product. • Use a three-wire socket and ensure that it is properly grounded. • Pull out the power plug from the socket if the product is not used for a long period. <p>Clean the dust and metal on the power plug regularly.</p> <ul style="list-style-type: none"> • Fire or electric shock may be caused if the product is powered on when you are cleaning. • Pull out the power plug before cleaning it with a dried cloth.
	<p>Do not put items on the top of the product.</p> <ul style="list-style-type: none"> • Do not put items, such as a container for liquid (a vase, flowerpot, cosmetics or liquid medicine) on the top of the product. • If any water or liquid is spilled on the product, short circuit may occur and cause fire or electric shock. • Do not walk on or hang any items on the product.



WARNING

	<p>Do not install the product in an improper place.</p> <ul style="list-style-type: none">• Do not install the product in humid places, such as the bathroom, the shower room, near windows, or outdoor environments that experience rain, snow or other harsh weather. Avoid installation near hot spring vapor. The preceding environments may cause faults in the product or electric shock under extreme conditions.• Do not put exposed fire source, such as an ignited candle, on the product.
	<p>Pull out the power plug during thunderstorms.</p> <ul style="list-style-type: none">• Do not touch the product during a lighting storm to avoid electric shock.• Install or place components that supply high enough voltage to cause personal injury out of the reach of children.
	<p>Do not touch the power cable with wet hands.</p>



CAUTION

	<p>Do not install the product in high temperature environments.</p> <ul style="list-style-type: none">• Do not install the product near a heat source, such as a radiator, a heat reservoir, a stove or other heating products.• Do not expose the product to direct sunlight, which may cause high temperatures and subsequent faults in the product.
	<p>For transport:</p> <ul style="list-style-type: none">• Pack the product for transport or maintenance by using the cartons and cushioning material provided with the product.• Vertically move the product during transport. The screen or other components are easily damaged if the product is moved by an improper way.• Before you move the product, disconnect all external connections and separate all toppling preventing products. Move the product carefully to prevent it from being hit or squeezed, especially the screen, which may cause injury if broken.
	<p>Do not cover or block up any vents on the product.</p> <ul style="list-style-type: none">• Any overheated components may cause fire, damage the product, and shorten the service life.• Do not lay the product down where the venting surface will be covered.• Do not install the product on a carpet or cloth.• Do not use a cloth such as table cloth to cover the product.



CAUTION



Keep away from the product when you use a radio.

The product complies with the international EMI standard to prevent radio interference. However, interference may still exist and causes noise in the radio. If noise occurs in the radio, try the following solutions.

- Adjust the direction of the radio antenna to avoid the interference from the product.
- Keep the radio away from the product.

Screen glass is broken or falls off.

- In case of screen glass breakage, keep all personnel 3 meters away from the screen to ensure safety.
- Do not perform any installation or disassembly when the screen glass is broken or falls off.

Use the battery correctly.

- Galvanic corrosion, electric leakage, and even fire may be caused by improper battery usage.
- It is recommended to use the designated type of battery and install the battery by correct electrodes (positive and negative).
- Do not install and use new battery with a used one.
- Take out the battery if the remote control is not used for a long period.
- Do not expose the battery to overheated environments such as sunlight and firing.
- Dispose of the used battery based on your local regulations.

Do not damage the power cable.

- Do not damage, change, twist, bend, or forcibly drag the power cable.
- Do not put weights (such as the product itself) on the power cable.
- Do not forcibly drag the cable when you pull out the power plug. If the power cable is damaged, please contact the local distributor to repair or replace it.
- The power cable in the accessory box is for this product only. Do not use it on other products.

Additional advice:

- Use the product in an environment with comfortable lighting. It is harmful to your eyes to watch in a too bright or too dark environment.
- Relax your eyes after a period of time for watching.
- Keep sufficient distance from the product to protect your eyes and prevent eyestrain.
- Adjust the volume to an appropriate level, especially at night.
- Use amplifier device as the audio input source with caution. If you must use amplifier device, the input power should not exceed the maximum of speaker power. Otherwise, the speaker can become overpowered and damaged.

About USB port.

Front USB 2.0 ports and rear USB 3.0/USB 2.0 ports switch connections based on signal sources. If the current signal source is reading the data from an external product connecting to the port, please switch the signal source after reading data is complete. Otherwise, the data or product may be damaged.

1 Overview

1.1 Parts

Front View

65"/75"/86":

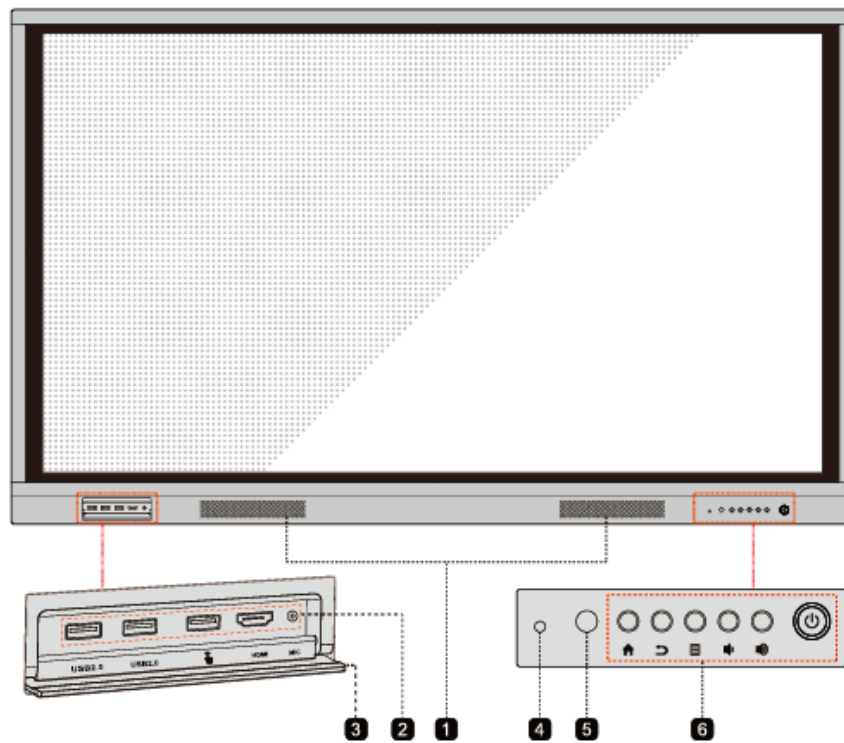

Rear View

75"/86":

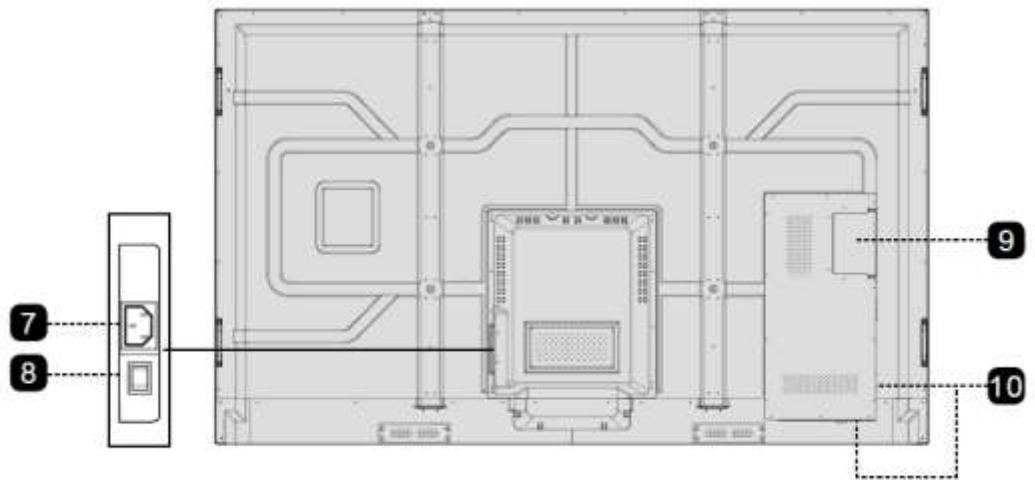

65":

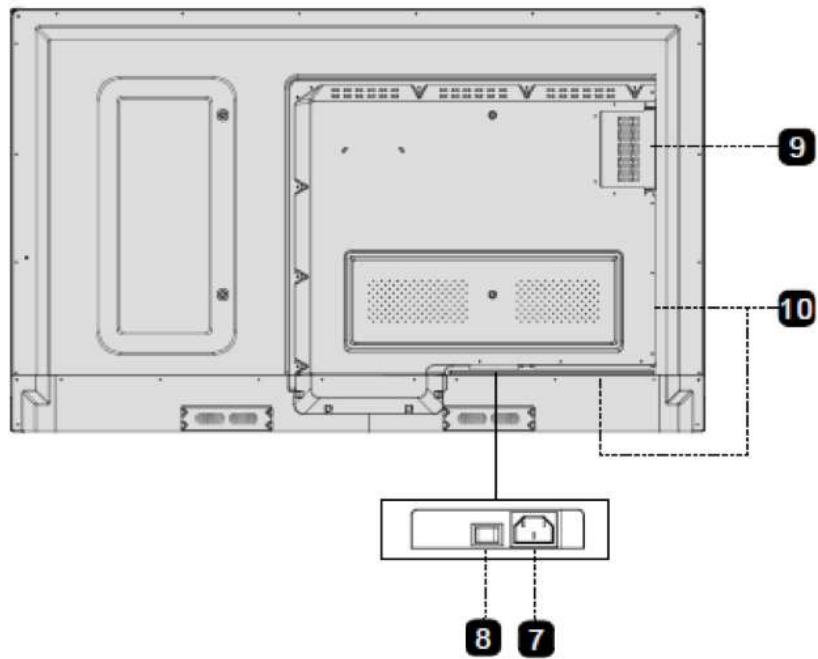

1	Speakers	6	Front Buttons
2	Front Ports	7	Power Supply Plug
3	Front Ports Cover	8	Power Switch
4	Light Sensor	9	Internal PC Port (OPS)
5	Remote Control Receiver	10	Rear Ports

1.2 Ports

Front Ports



CAUTION

Front USB 2.0 ports and rear USB 3.0/USB 2.0 ports switch connections based on signal sources. If the current signal source is reading the data from an external product connecting to the port, please switch the signal source after reading data is complete. Otherwise, the data or product may be damaged.

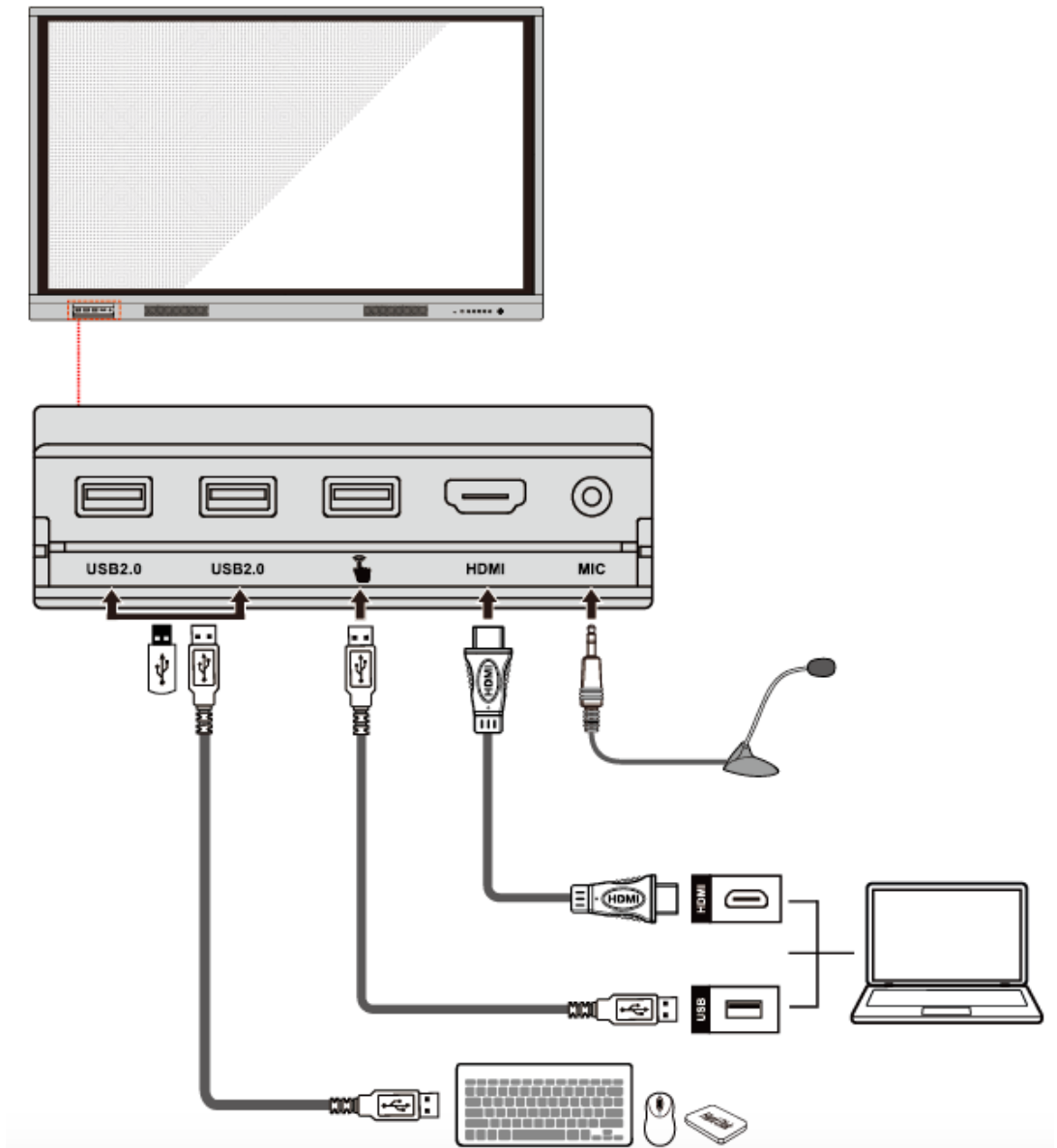

Rear Ports

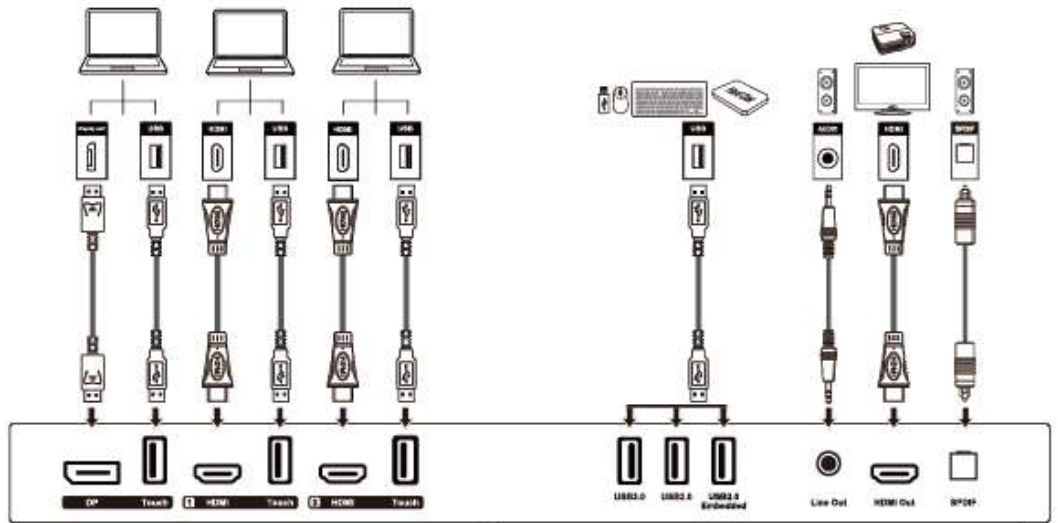

• 75"/86"

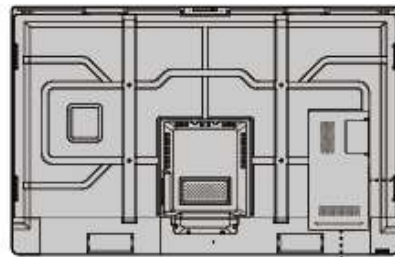



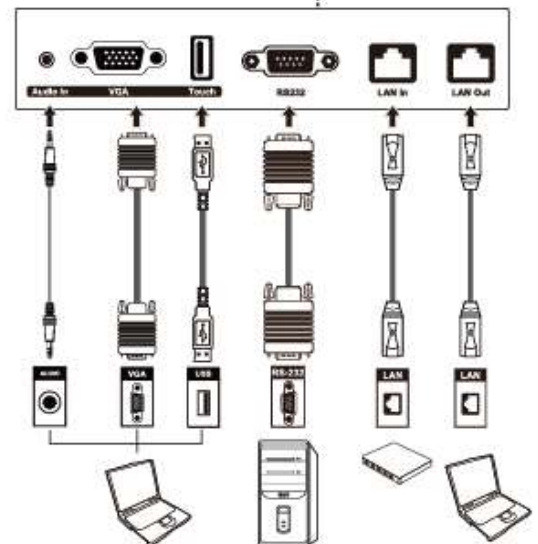
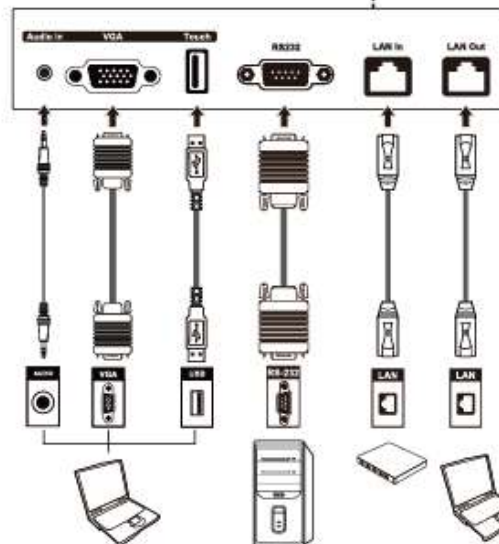
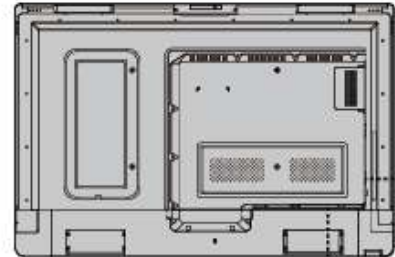

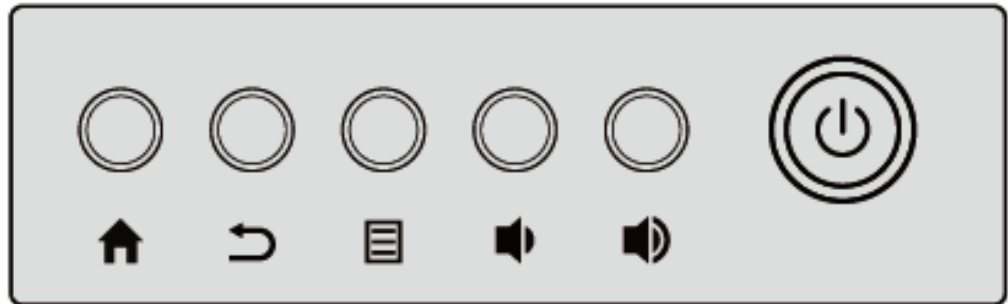

• 65"



Front Buttons



Button	Operation	Function
	Short press	Go to the Home page
	Short press	Return to the last menu/Exit
	Short press	Open the External Source Menu (only can be used in the external source interface)
	Long press for 2 seconds	Go to Screen lock
	Short press	Decrease the sound volume
	Long press for more than 1 second	Decrease the sound volume continuously
	Short press	Increase the sound volume
	Long press for more than 1 second	Increase the sound volume continuously
	Short press	Power on/off <ul style="list-style-type: none"> • Steady on red: Powered on, not booted • Steady on white: working state • Blinking on red and white: Powering off (Internet PC installed)

1.3 Remote Control



Carefully read the following instructions before using the remote control to avoid possible faults:

- Do not drop or damage the remote control.
- Do not spill water or other liquids on the remote control.
- Do not place the remote control on a wet object.
- Do not place the remote control directly under sunlight or near an overheating heat source.

Button	Operation
	Power On/Off
	Mute/Unmute
0-9	Enter Number
	Go to the Home Page
	Return to Previous/Exit
	Up/Down/Left/Right
	Confirm/OK
	Enter Whiteboard Mode
	Take a Screenshot
	Enable Sound Only Mode
	Freeze the Current Screen, Click Again to Exit Freeze Function
	Adjust the Sound Volume
	Adjust the Brightness (10 to 255)
	Enter the Source Selection Page
	View Currently Running Applications
	Open the File Manager
	View all Pre-installed Applications



Button	Operation
PC	Switch Source to Internal PC
DP	Switch Source to Display Port
HDMI FRONT	Switch Source to HDMI Front
HDMI 1	Switch Source to HDMI 1
HDMI 2	Switch Source to HDMI 2
VGA	Switch Source to VGA
	Auto correction Screen Display (For VGA Signal Source)
	Open the Browser Application
	Toggle Display Backlight Mode
	Start/Exit the Screen Lock Function
	Open the External Source Menu
	Open the System Settings

1.4 Temperature Control

In certain special installation or operation environments, the ventilation condition of the screen is poor and the heat dissipation efficiency is low. As a result, the internal temperature may rise. When the internal temperature sensor detects that the temperature has reached the threshold, the system will go to the shutdown mode to avoid any permanent damages to the components caused by high temperature. Please check the device and environment, and turn the power on again.

2 Installation Guide

2.1 Safety Precautions

Installation Environment



Installation Direction

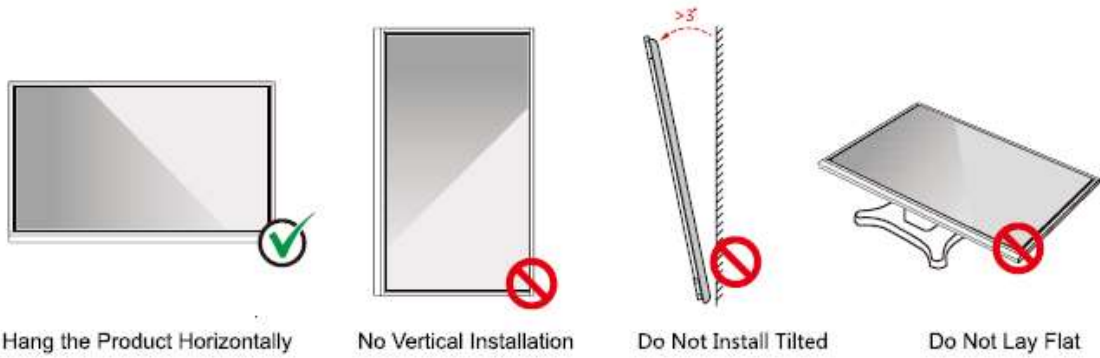

Installation Height

Recommended installation height from the floor to the bottom of the screen: 700 mm/27.6 in (86"), 730 mm/28.7 in (75"), 860 mm/33.9 in (65")

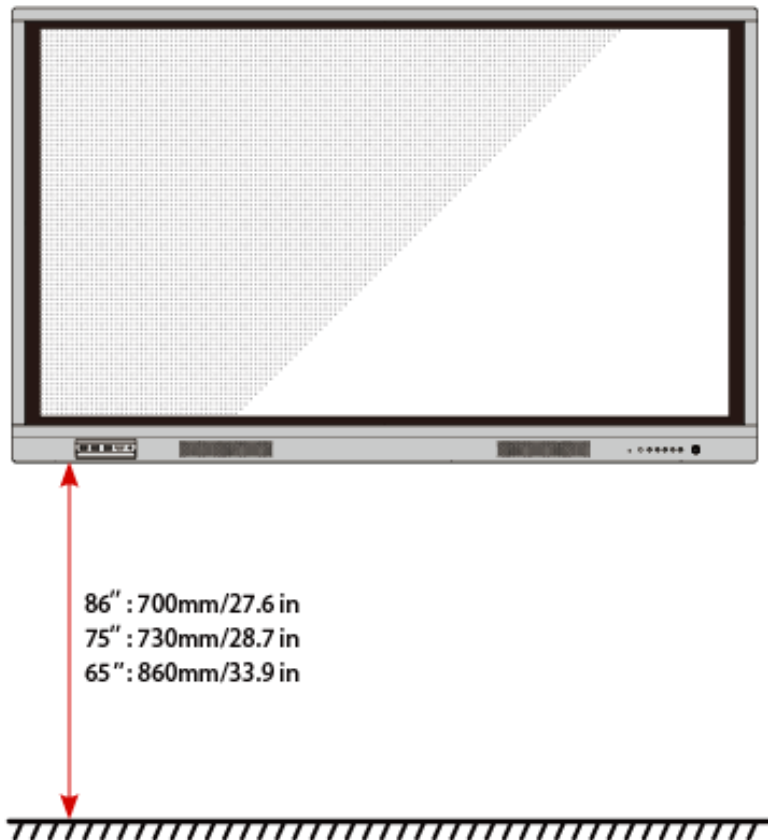

2.2 Installation Precautions

Weight Loading

Weight of the product: 160.9 lb/73.0 kg (86"), 125.7 lb/57.0 kg (75"), 97.0 lb/44.0 kg (65")

- When using a mobile stand, ensure that the weight of the product is less than the loading capacity of the mobile stand.
- When using the wall-mount bracket, ensure that the wall can support the weight of the product. We recommend that the wall surface be reinforced and have a loading capacity 4 times of the weight of the product. Consult a professional installer for wall-mount installation.

NOTE

The company does not undertake relevant legal responsibility for any problems caused by improper operation, if the third party mobile stand, or wall-mount bracket is beyond the scope of the product.

- Do not install the product where it might be hit by a door.

Vertical installation

When installing, try to keep the product vertical. Excessive tilt angle may cause the screen glass to fall off or the product to collapse.

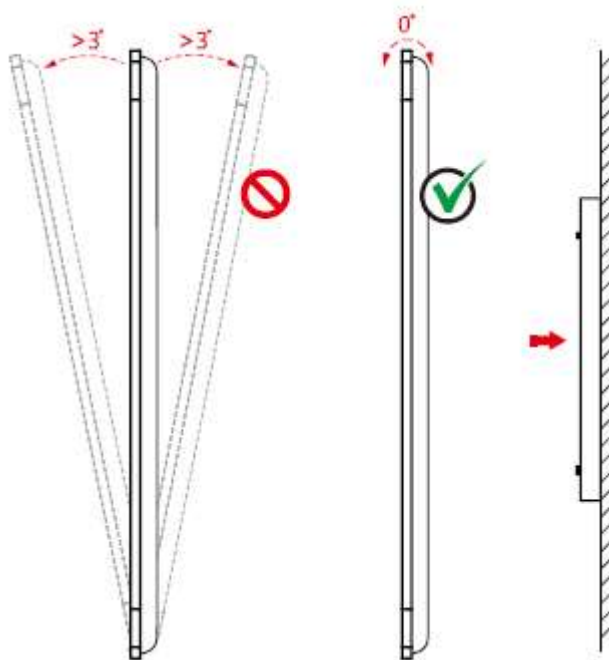

NOTE

For any problem, please contact our support desk. Our company is not responsible for any damage or losses incurred by users if the users fails to follow the instructions.

Ventilation

Ensure adequate ventilation and/or air conditioning environment. We recommend keeping certain distances from the side of the product to the wall or panels. Proper space for ventilation is shown in the following figure.

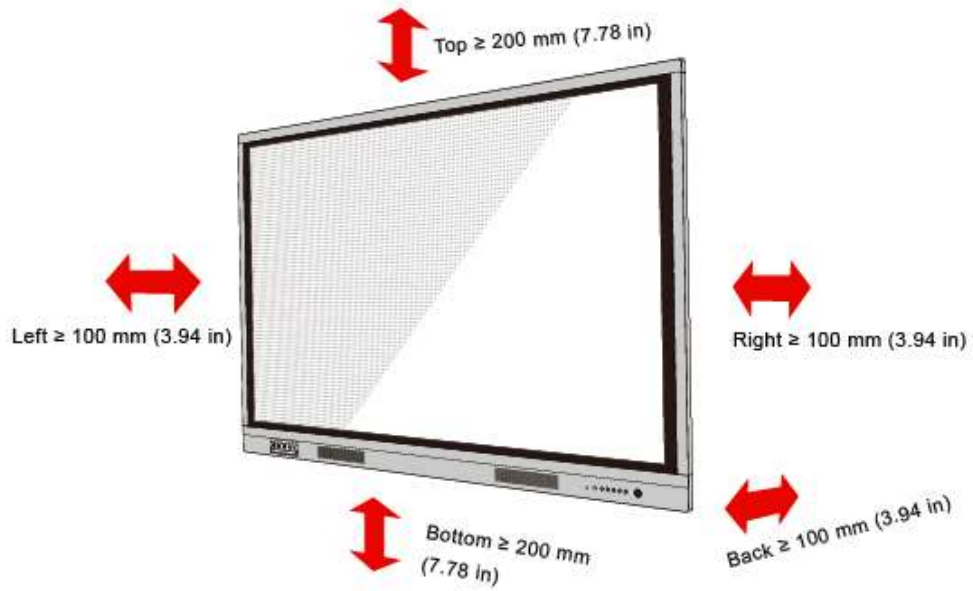

2.3 Installation

The dimensions of the four bracket mounting holes on the back panel are VESA MIS-F compliant (86" or 75": 800 x 400 mm/31.50 x 15.75 in; 65": 600 x 400 mm/23.62 x 15.75 in). Use metric M8 screws with a length of 10 mm to 15 mm (0.40 to 0.59 in) to secure the touch screen with the mounting system. Dimensions of the mounting holes on the back panel are shown in the following figure.

NOTE

Consult a professional installer to install the display product.

75"/86":

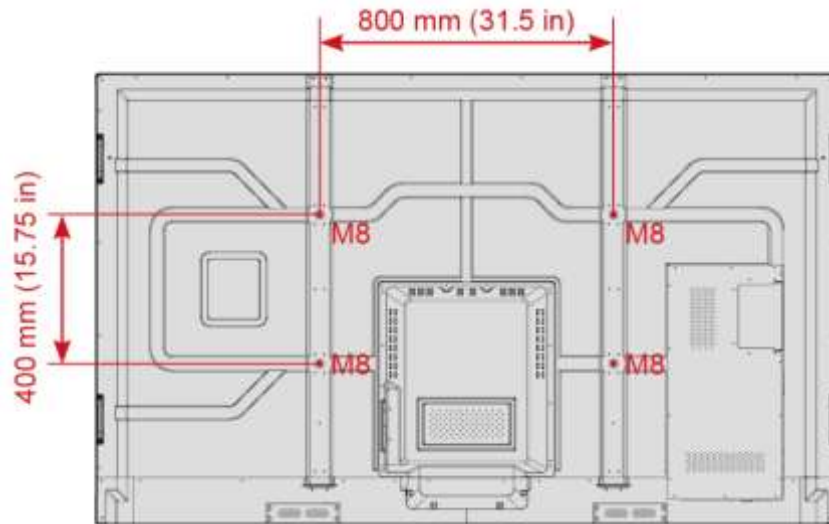

65":

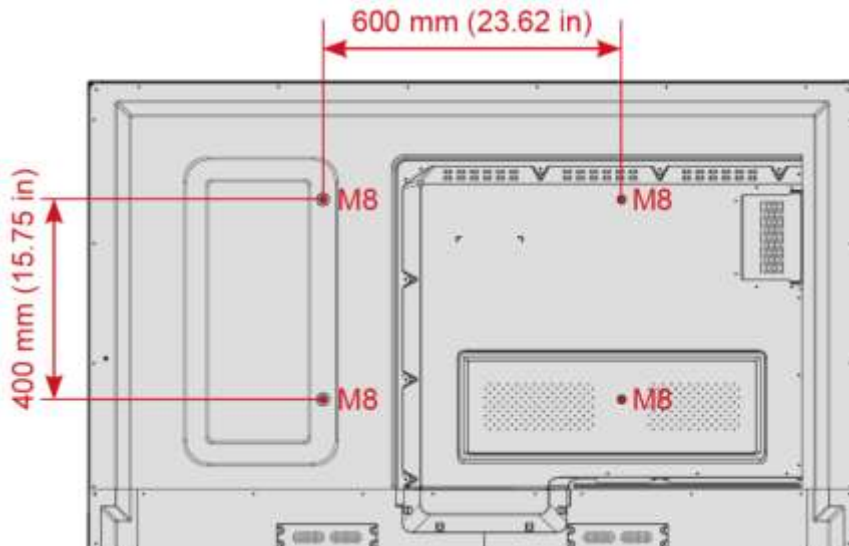

2.4 Installing the Internal PC (Optional)



The internal PC does not support hot plugging. Therefore, you must insert or remove it when the screen is powered off. Otherwise, the screen or internal PC may be damaged.

You will need to purchase the internal PC separately. Perform the following steps to install the internal PC.

Step 1 Unscrew the M3 screws by hand to remove the internal PC shielding cover.

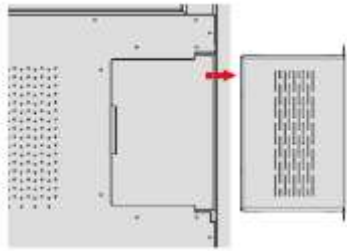

Step 2 Push the internal PC into the port at the rear of the screen from right to left.

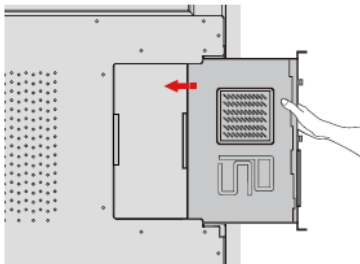

Step 3 Secure the internal PC to the display by using the M3 screws.

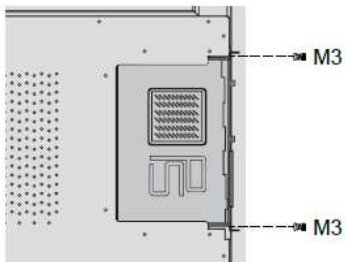

Step 4 Ensure the installation is correct before turning the power on again.

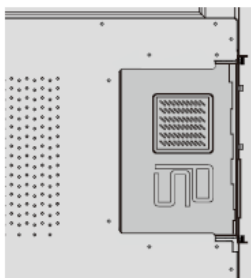

3 Getting Started

3.1 Power On

Step 1 Plug the power supply into the power outlet fully and plug the power connector into the side of the product. Ensure the power is in the range of 100 V to 240 V with a frequency at 50 Hz/60 Hz \pm 5%. The power current must be grounded.

 **NOTE**

The power outlet should be installed near the device and should be easily accessible.

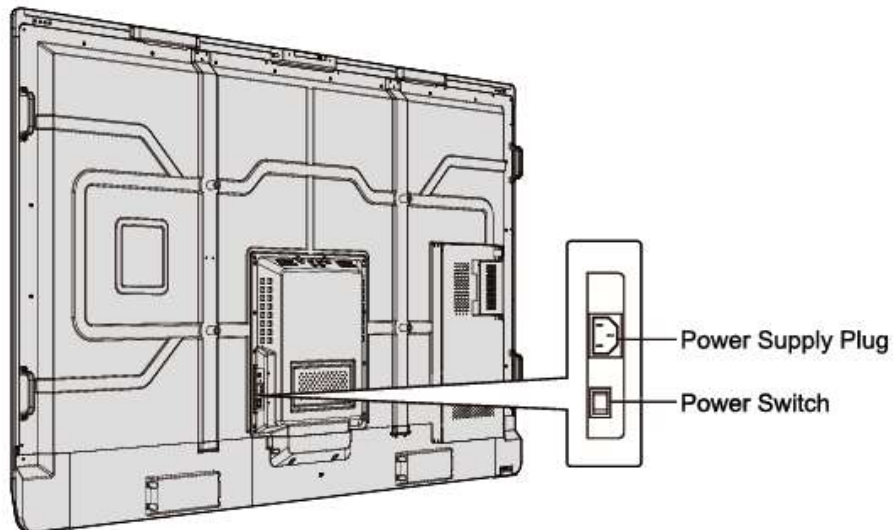

Step 2 Flip on the power switch located on the side of the product to "On".

75"/ 86":



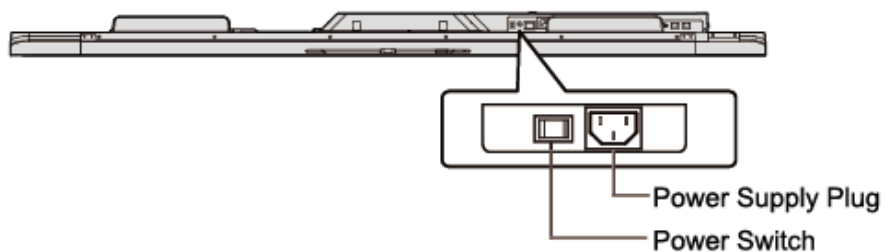

65":





Step 3 Press the power button  on the front control panel or  on the remote control.

3.2 Power Off

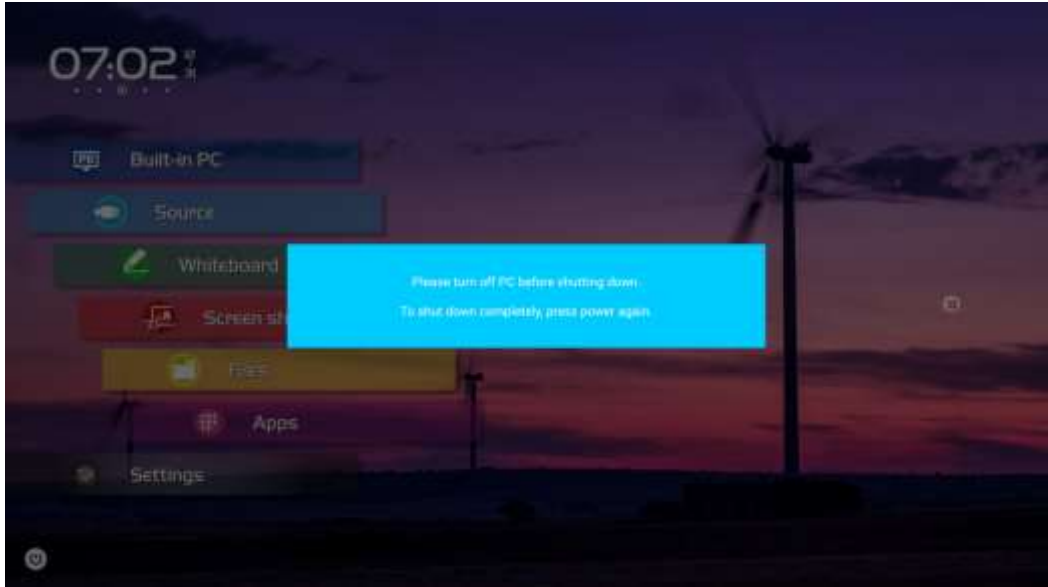
Step 1 Press the power button  on the front panel or the power button  on the remote control. The information will be displayed as shown in the following figure.



Step 2 Press the power button  on the front panel or the power button  on the remote control again, the power indicator will turn to red.

Step 3 If you are not going to use the product for an extended period of time, we recommend you switch the power switch to "Off".

 **NOTE**

- If an internal PC is equipped, the internal PC and the screen are powered off simultaneously when you power off the system.
- Do not forcibly disconnect the power supply of the screen when the internal PC is on.

 **NOTE**

Interface operation on the Smart system does not need positioning. External products with Microsoft Windows 7 or later versions require positioning.

3.3 Calibration

If the cursor position has a big deviation from the actual touch point, calibration is used to eliminate the deviation. Positioning is required in the following scenarios:

- The internal PC is used.
- A computer is connected through the HDMI, Display Port and VGA interface.

If positioning is not correct, perform the following operations to calibrate again. The following takes Windows 10 as an example:

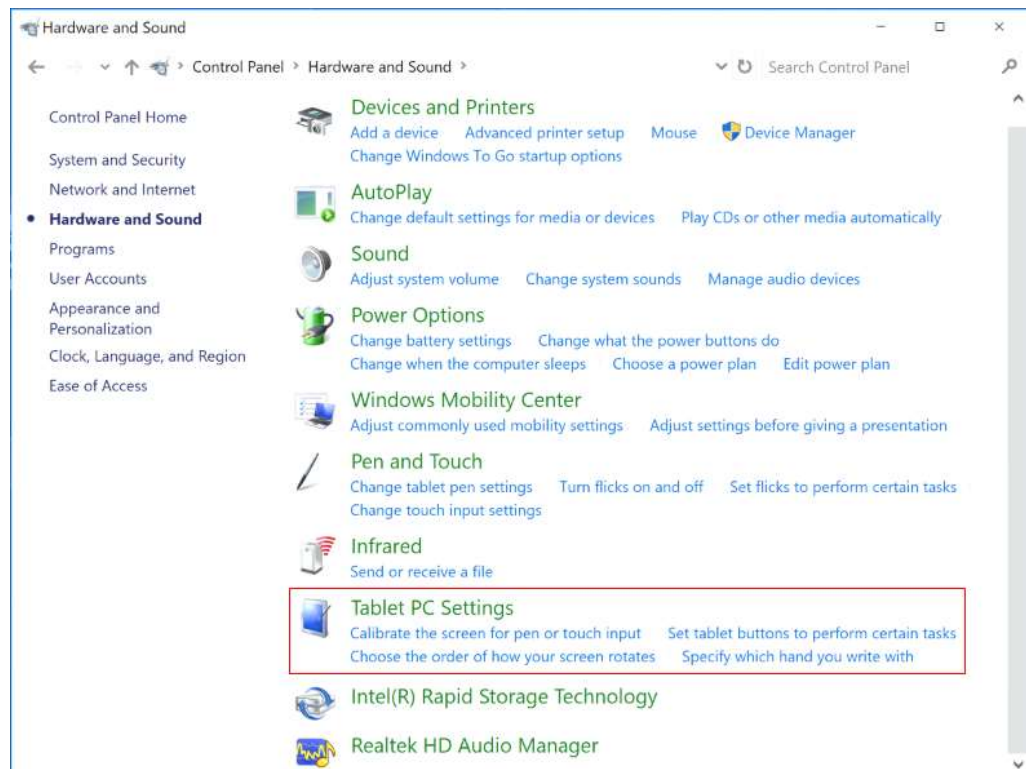

- Step 1** Ensure that the HDMI or DP interface and external products are connected properly.
- Step 2** Select the corresponding Windows signal from the signal source menu. The Windows page will be displayed.
- Step 3** Select **Tablet PC Settings** on the **Control Panel** page.

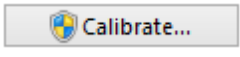

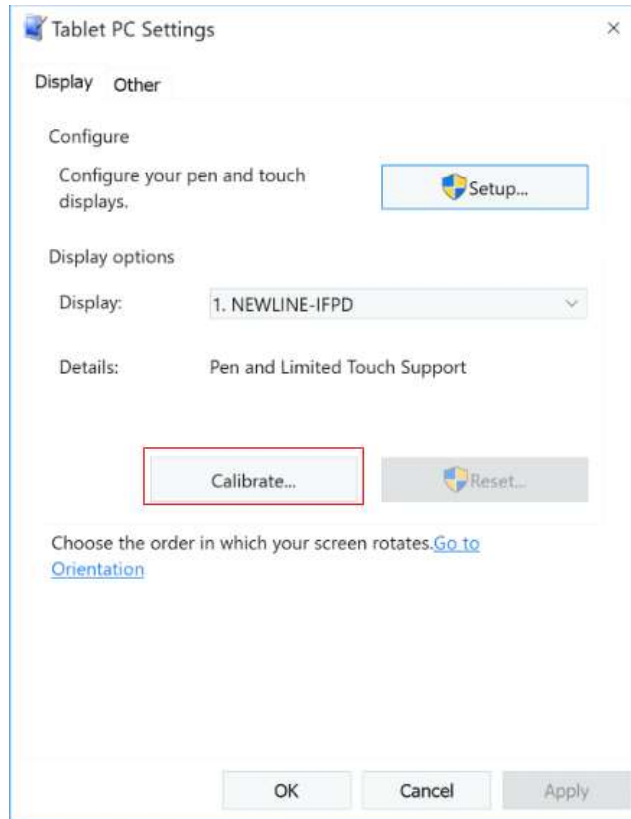
- Step 4** Select  in the Tablet PC Settings window.



Step 5 Select **Touch Input** from the option and start calibration.

Step 6 Use finger or pencil to click and hold the center of the flickering crosshair . Do not release until  moves to the next positioning point. Complete the calibration process as instructed.

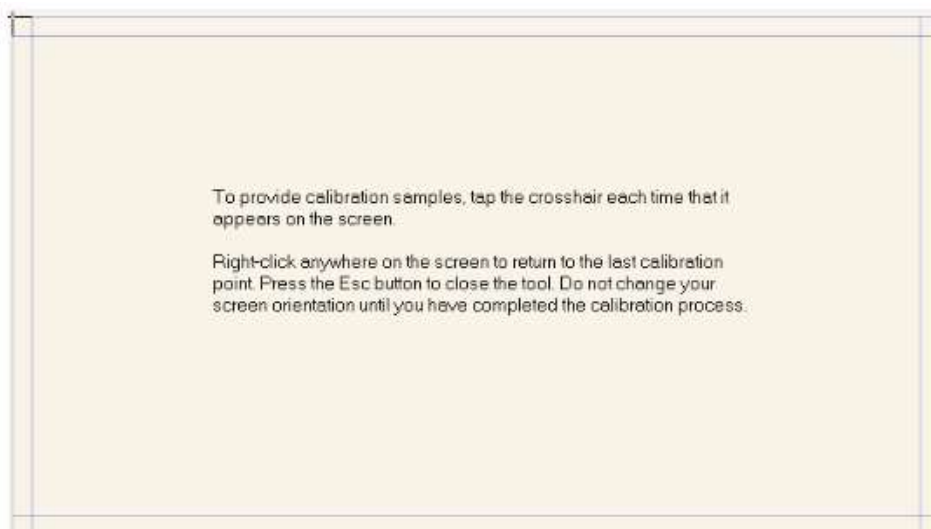

Step 7 After the calibration is complete, the **Digitizer Calibration Tool** dialog box will be displayed. Click **Yes** to save calibration data.

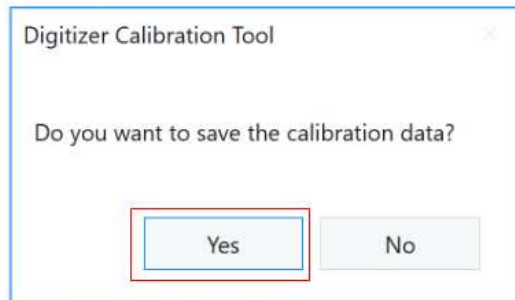

 **TIP**

- To ensure writing accuracy, use the pencil or stylus included with the product for proper positioning.
- Positioning errors may cause failure of touch functions of the display. In that case, please perform positioning again.

Step 8 The **Tablet PC Settings** dialog box will be displayed again. Click **OK**. Positioning will be complete.

4 Operating the Touch Screen

4.1 Start Screen

When the product is turned on, the product will show the Start Screen page, as shown in the following figure.



4.2 Home

Touch the screen to start a meeting, and the product will go to the **Home** page, as shown in the following figure.



- 1: Clock 2: Date and Week 3: Main Toolbar 4: Status Bar and Start Screen Shortcut
 5: Floating Toolbar

Shortcut for Clock, Date and Week

Click the time or date icons at the top left corner of the Home page to enter the page of time and date settings. The icons at the top left corner of the page are alarm, clock, timer, Stopwatch. Click











to add the time zones represented by other countries, as shown in the following figure.



Floating Toolbar



Pressing any part of the screen with 2 fingers for longer than 2 seconds, the floating toolbar will appear by your fingers. You may hold the center part and move it. After 5 seconds without operation of the toolbar, it gradually becomes translucent. Click the toolbar or press any part of the screen with 2 fingers for longer than 2 seconds again and you may bring it back.



The functions of the floating toolbar are as follows:

Icon	Function
	Click to enter the annotation mode.
	Click to enter the discussion mode.
	Click to exit from current program or source to the Home page.
	Click to back to the previous step or exit from current program.
	Click to enter the internal PC source.
	Click to enter the favorite source. The user can change the icon to favorite source in the setting page.
	Click to enter managing currently running applications. Slide left/right the currently running application or click "x" at the upper right corner to close the application.
	Click to expand or close the icons.









Status Bar and Settings

The bottom left corner of the Home page displays three working status icons (including USB flash memory(s), Ethernet, and Wi-Fi) and start screen shortcut.

Icon	Function
	Click the icon to go back to Start Screen.
	If the product is connected to Ethernet, the icon will be displayed. Click the icon to enter the corresponding setting menu.
	If the product is connected to a wireless network, the icon will be displayed. Click the icon to enter the corresponding setting menu.



Icon	Function
	<p>If USB flash memory(s) is connected to the USB port, this icon will be displayed. Click the icon to enter File Commander.</p> <p> NOTE If the meeting notes cannot be saved to a USB flash memory successfully after the meeting, use a USB flash memory less than 16 GB and change the file system into FAT 32 format.</p>

Main Toolbar

Icon	Function
	<p>Click to enter the internal PC system or the user may set their favorite source frequently used. (More details setting method refer to the 4.3.11 Input/Output Setting)</p>
	
	<p>Click Source to show the Source page on the right hand side.</p> <p>Signal sources include Internal PC, HDMI Front, HDMI Rear (1 and 2), DisplayPort and VGA.</p>
	<p>Whiteboard provides discussion board function.</p>
	<p>Click the bar to share the screen from portable devices, such as laptop and tablet.</p>
	<p>Files is for opening the File Manager, and you can explore on internal and external files of the screen.</p>
	<p>Apps display all pre-installed applications, including Browser, Chromium, Calculator, Vote, Trucast, File Commander, Office Suite and Aqual Mail,etc.</p> <p>Click the icon of an application to run the application.</p>
	<p>Click Setting to enter the setting page.</p>

4.3 System Settings

Enter the system setting page using one of the following methods:

- Click  on the **Home** page.
- Press  on the remote control.
- In the **Quick Setting Menu**, click the  icon.

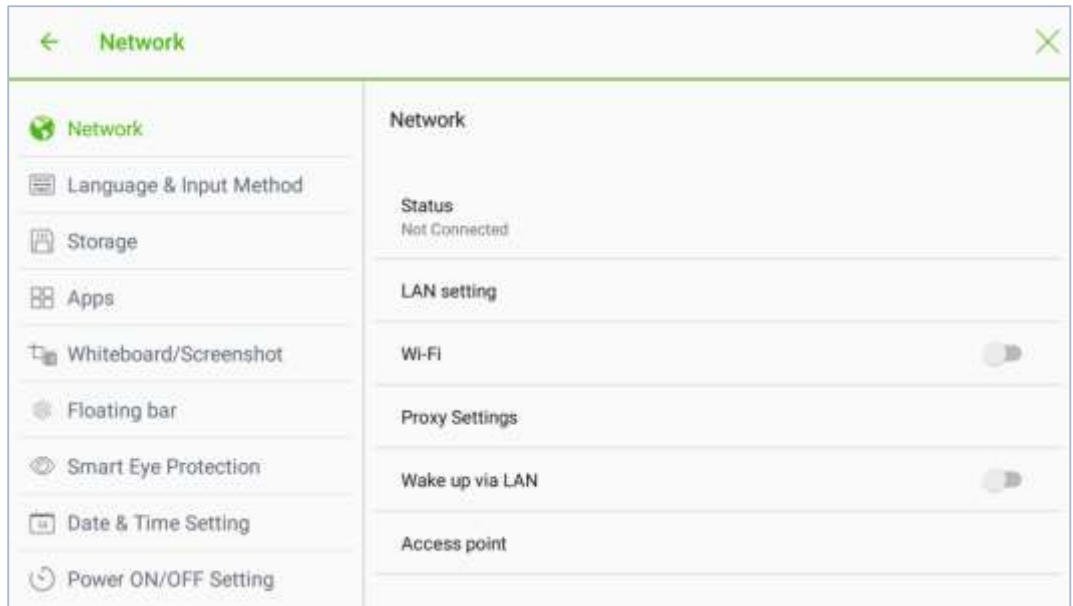

4.3.1 Network Settings

Enter the **Network** submenu to set a LAN, enable Wi-Fi, view network information, and enable the Wake up via LAN function.

- **Status:** View IP address, MAC address and work time of the screen.
- **LAN setting:** Automatically obtain the LAN IP address or set static IP address according to requirements.
- **Wi-Fi:** Click the corresponding button to enable the Wi-Fi function.
- **Proxy Settings:** The settings of the proxy server.
- **Wake up via LAN:** Click the corresponding button to enable the Wake up via LAN function. Connect the screen and PC to the same LAN using cables, run the Wake up via LAN, and search for the IP address and MAC address that match the screen.
- **Access point:** The settings of the hotspot.

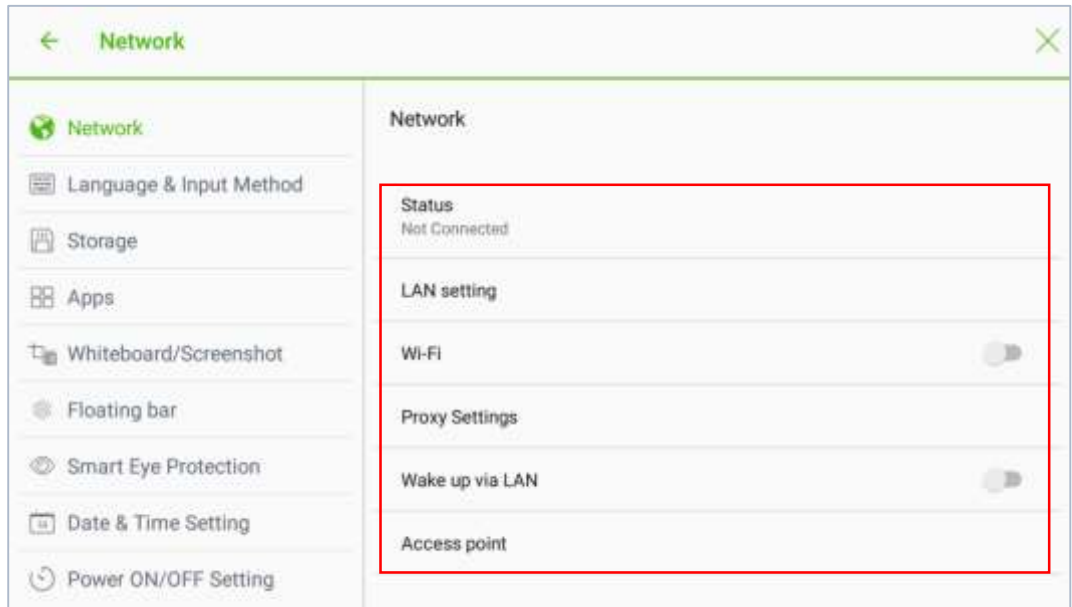

4.3.2 Language and Input Method Settings

Enter the **Language & Input Method** submenu to set language and input method.

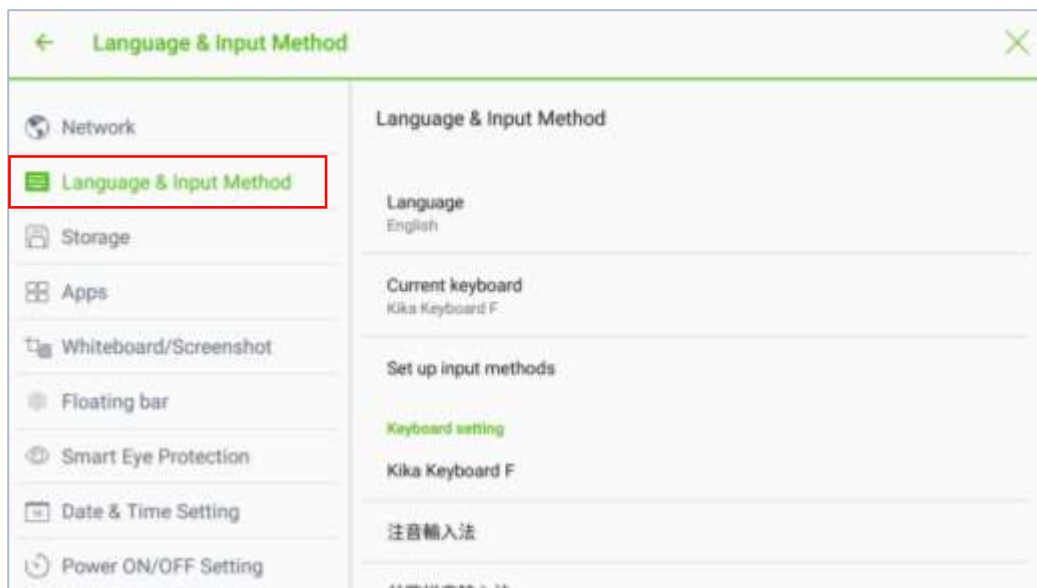

The default input method of the system is **Kika Keyboard F**, and **Hardware** must be enabled. Click **Current keyboard** to show as the following figure.

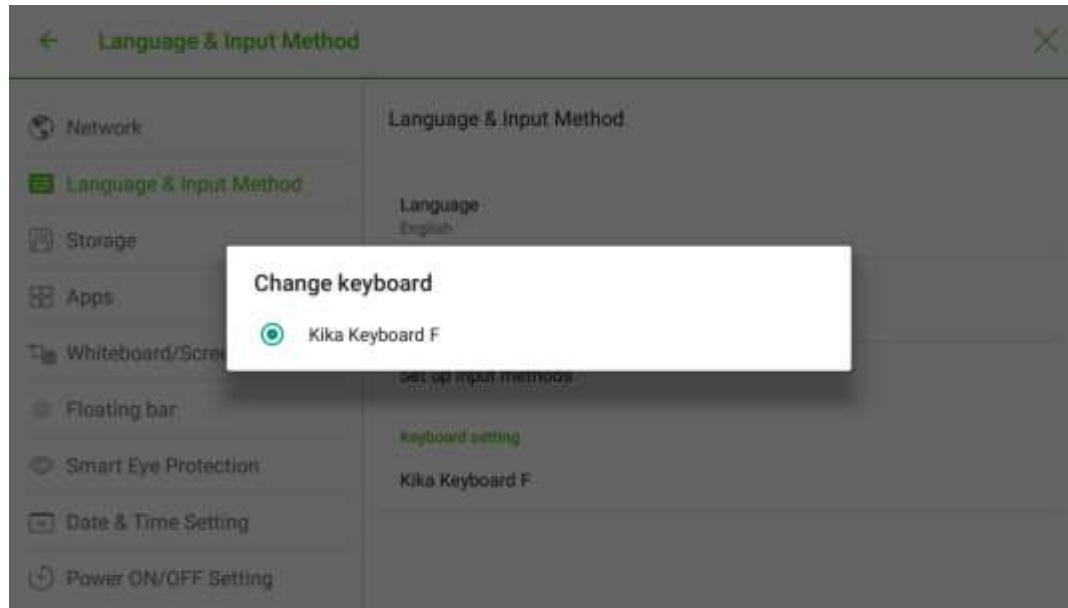

Setting a Language

Click **Language** at the right side. In the **Change language** dialog box that is displayed, select a language.

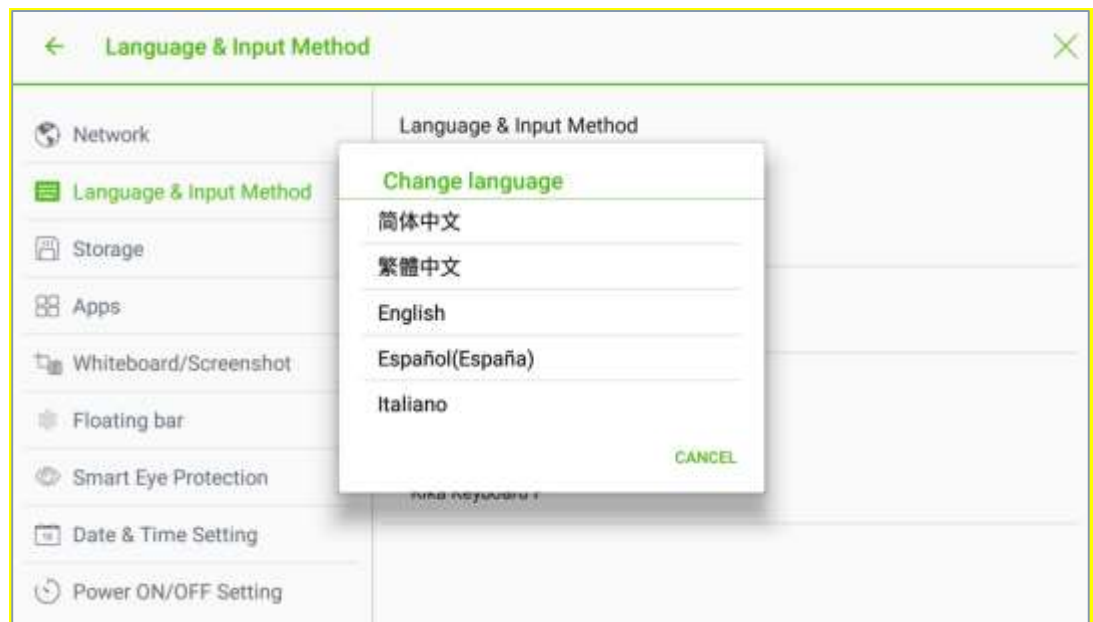

Setting up Input Method

Click **Set up Input Methods** at the right side. Select an input method at the right side to set the attributes of the input method.



4.3.3 Storage

Enter the **Storage** submenu to view space distribution of the internal storage.

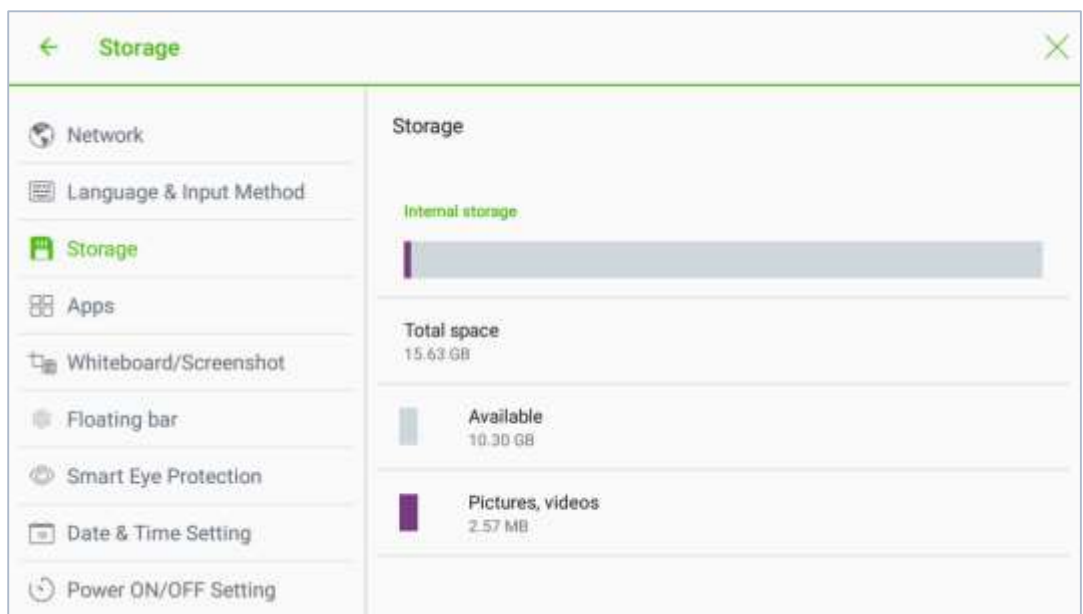

4.3.4 Applications

Enter the **Apps** submenu to view downloaded applications by type, running applications, and all applications.



4.3.5 Whiteboard/Screenshot

Enter the **Whiteboard/Screenshot** submenu to set automatically clearing the whiteboard data cycle.

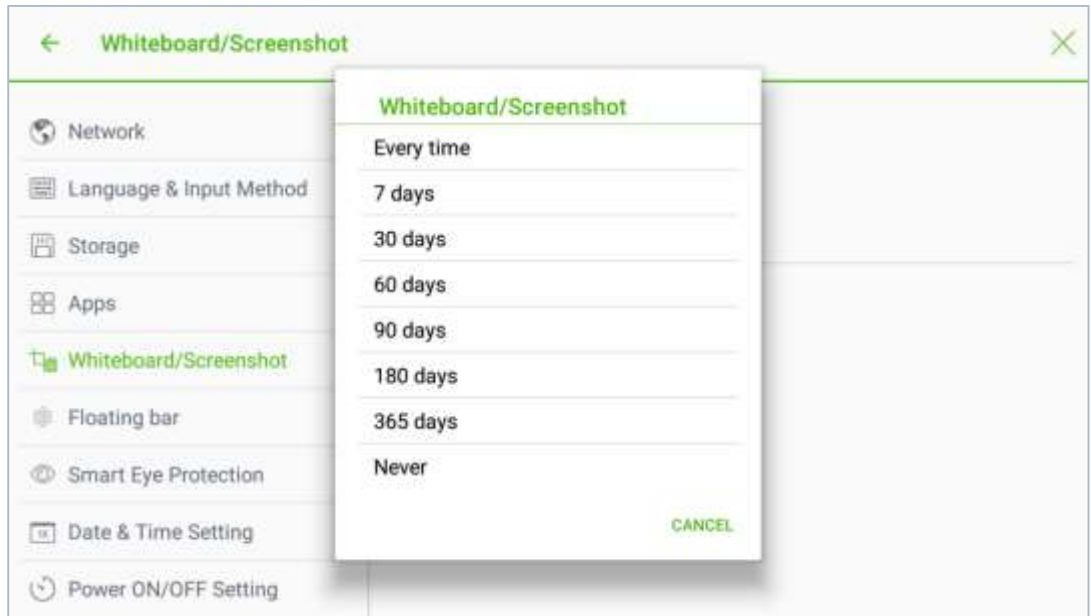

4.3.6 Floating Bar

Enter the **Floating bar** submenu to disable the **Floating bar** or set **Floating bar size**, standard and large size can be chosen, such as the following figure:

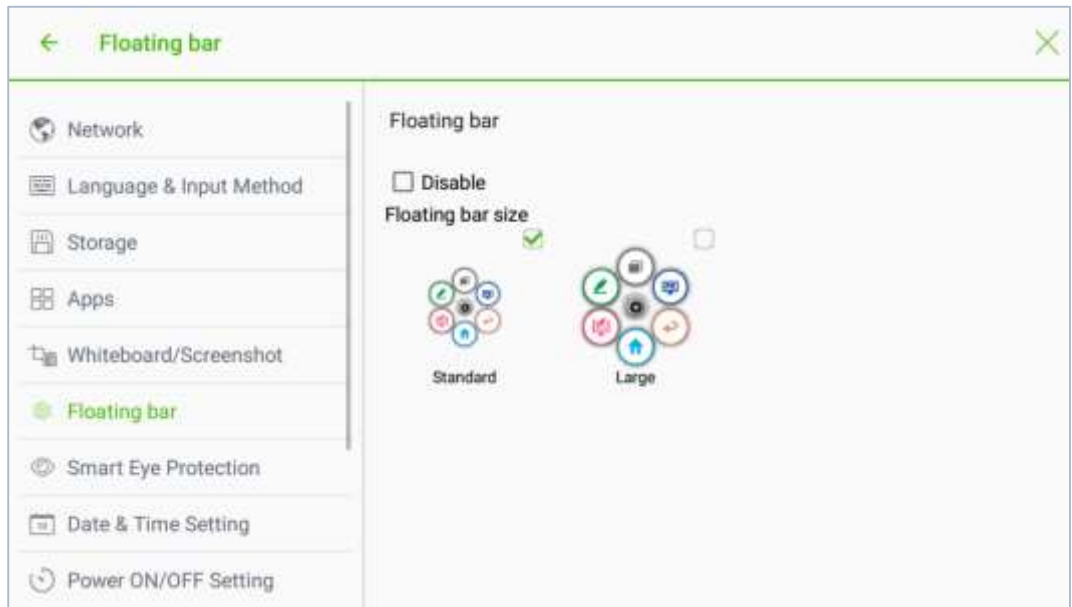

4.3.7 Smart Eye Protection

Enter the **Smart eye protection** submenu to set **Eye protection writing mode**, **Eye protection brightness control mode** and **Bluelight filter**. Only when **Bluelight filter** is opened can **Filter level** be set.



4.3.8 Date and Time Settings

Enter the **Date & Time Setting** submenu to set the date and time. Before setting the date and time, users should click **Select time zone** to select local time zone.

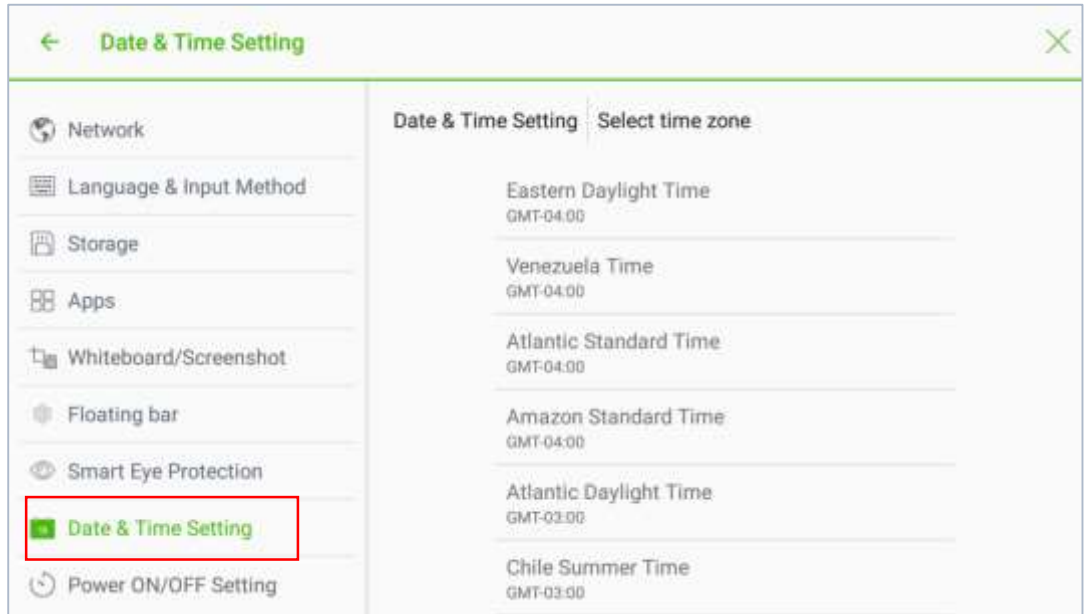

Setting a Date

You can automatically obtain the system date or customize a date.

- To automatically obtain a date, select **Automatic date & time**.

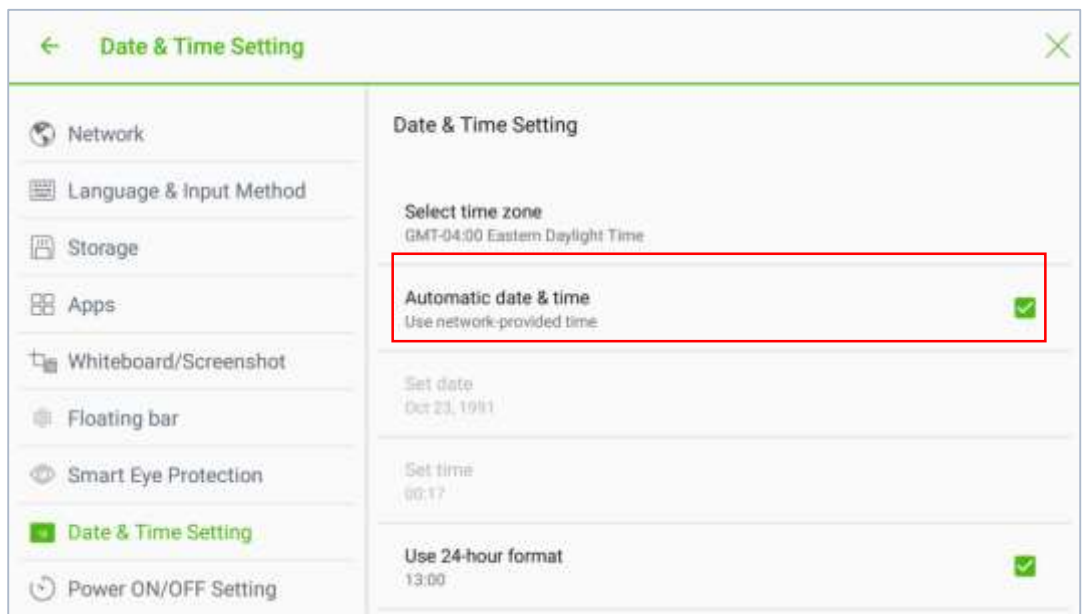

- To customize a date and date format, set them in **Set date**.

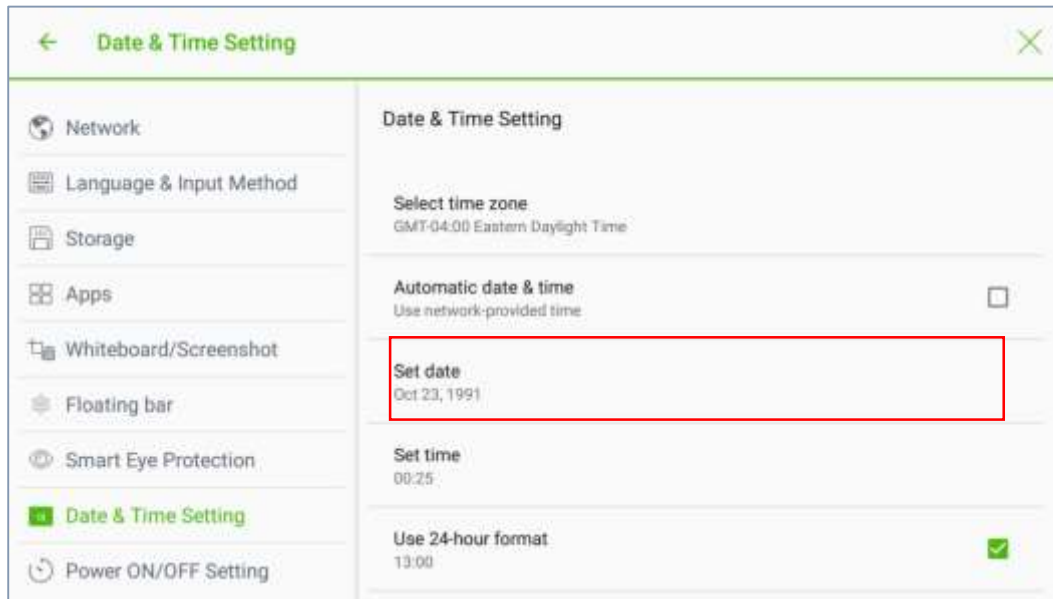

Setting Time

You can automatically obtain the system time or customize time.

- To automatically obtain time, select **Automatic date & time**.

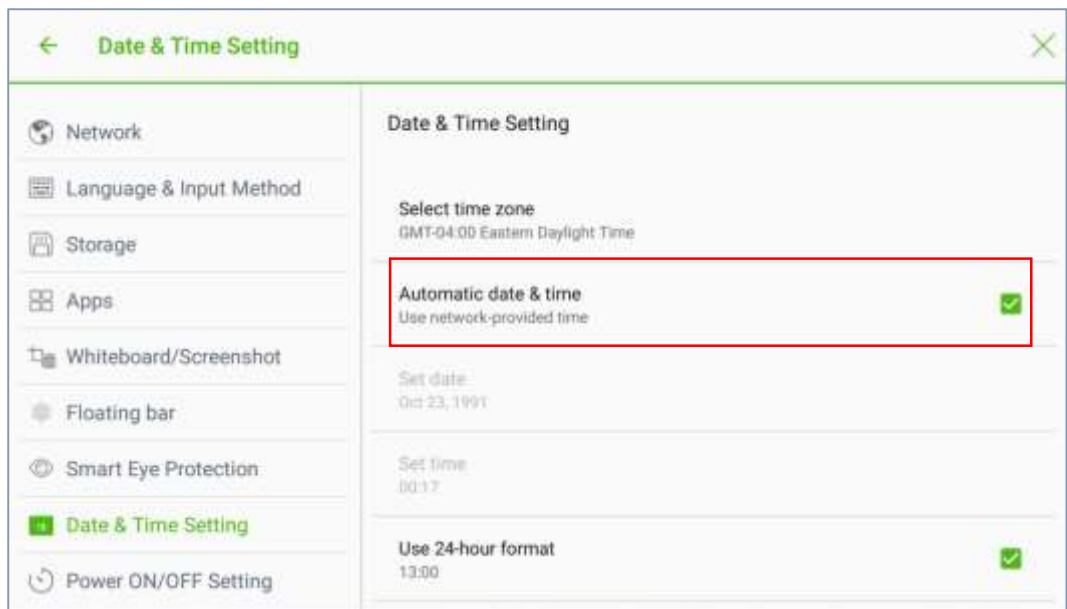

- To customize time and time format, set them in **Set time** and **Use 24-hour format**.

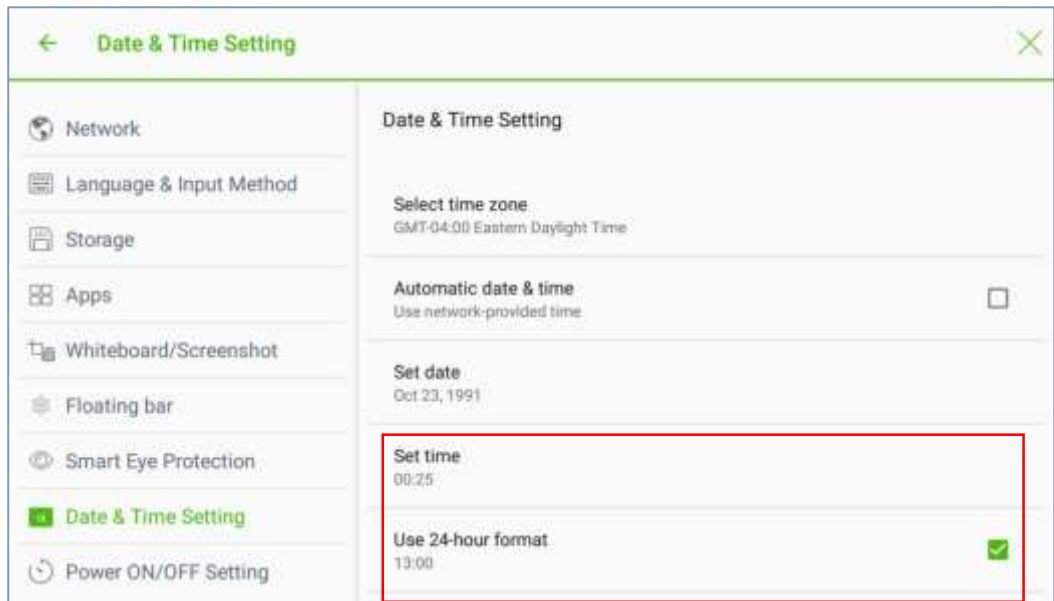

NOTE

Time format will be 24-hours mode only when the **Use 24-hour format** is selected, otherwise time format will be 12 hours mode.

4.3.9 Power ON/OFF Setting

Enter the **Power ON/OFF Setting** submenu to set automatic power on/off time, the time for the system to enter the power off mode and the automatic power on/off function of the consumer electronics control (CEC) device.

- To set the automatic power on time, select **Auto power on**, and set the power on time in **Power on time**, as shown in the following figure.



- To set the automatic power off time, select **Auto power off**, and set the power off time in **Power off time**, as shown in the following figure.



- To set the energy saving time, click **Energy saving**. In the dialog box that is displayed, set a duration after which the screen enters the lock mode if the screen is left un-operated. After the screen is locked, if the user does not operate the screen within 120s, the screen enters the power off mode. The duration can be set to **30 MIN**, **60 MIN**, **90 MIN**, or **NEVER**. You can also customize this duration and the range is 3 minutes to 480 minutes.



NOTE

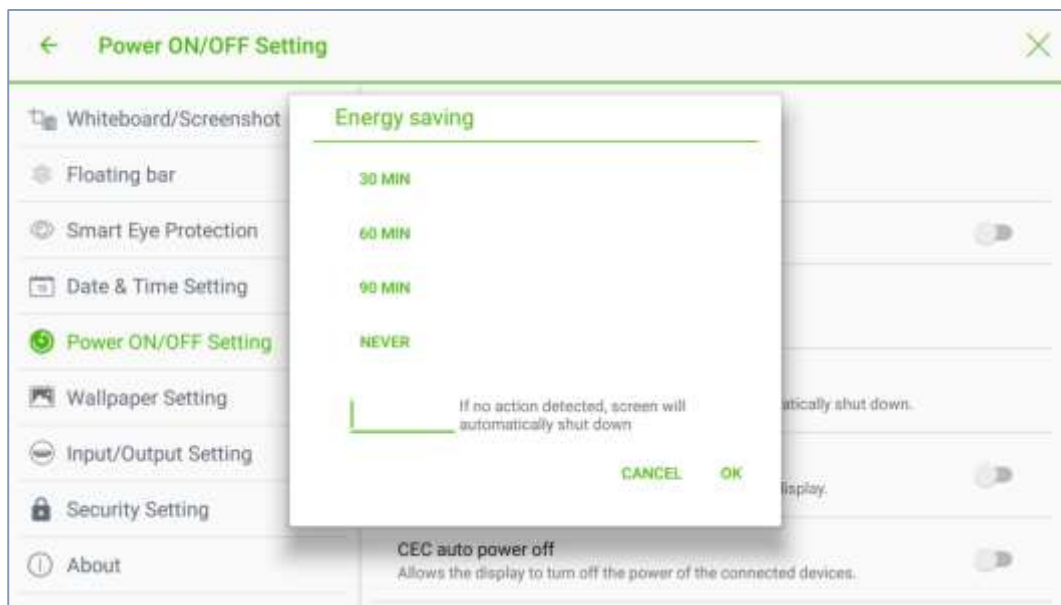

NEVER indicates that the automatic power off mode function is not enabled.



- After the **CEC auto power on** function is enabled and the screen is connected with the CEC device via the HDMI port, the screen automatically starts if the CEC device starts and the screen receives a CEC power on command.
- After the **CEC auto power off** function is enabled and the screen is connected with the CEC device via the HDMI port, the CEC device automatically stops if the screen stops and the CEC device receives a CEC power off command.

4.3.10 Wallpaper Setting

Enter the **Wallpaper Setting** submenu to set background.

In the page, click  to select the picture locally as the wallpaper. Click  to delete the selected picture.

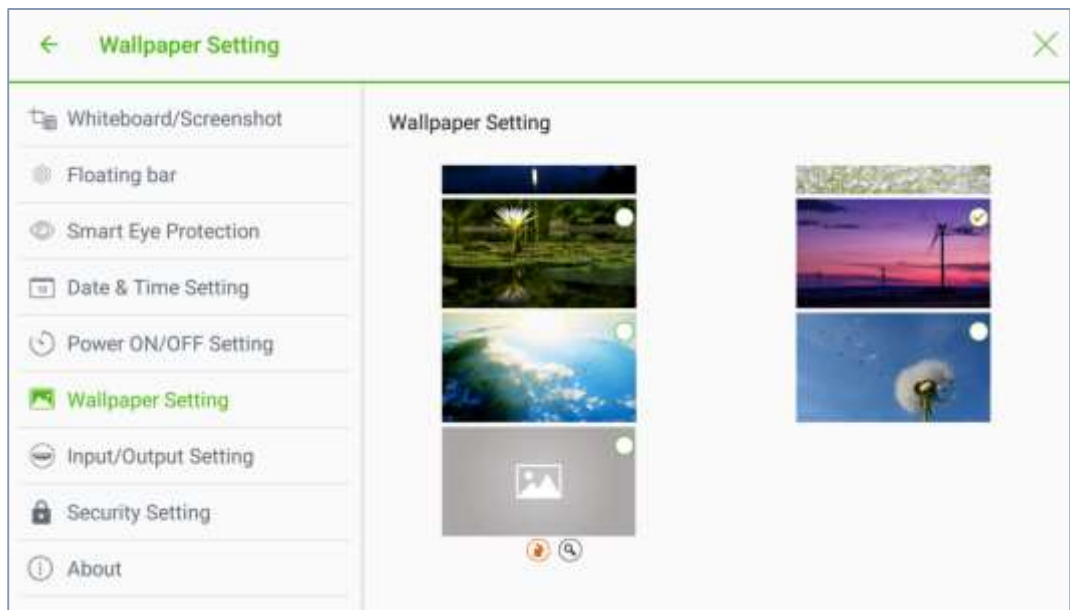

4.3.11 Input/Output Setting

Enter the **Input/Output Setting** submenu to set the favorite source, starting source, new signal source, and resolution of image output through the HDMI port.

- **Favorite source:** Set the commonly used signal source. After that, the shortcut key for the signal source will be displayed in the floating toolbar and main toolbar.
- **Starting source:** Set the signal source entered after power on.
- After the **New input source** function is enabled, the system can automatically switch to the screen of the newly connected signal source.
- **HDMI output resolution:** Set the resolution of the picture exported through the HDMI port.

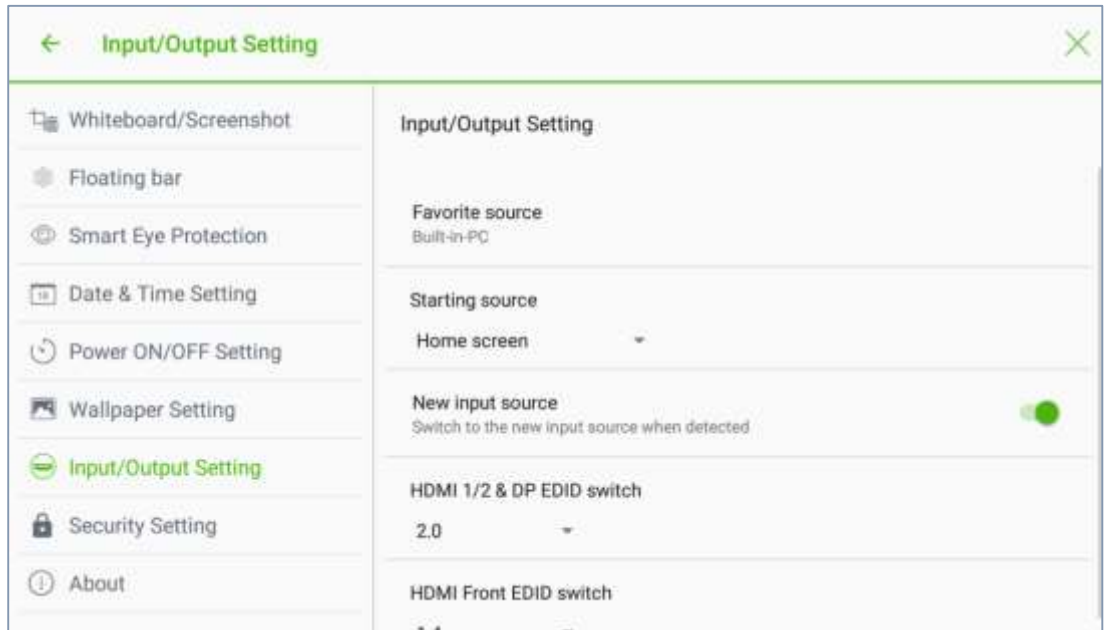

4.3.12 Security Setting

Enter the **Security Setting** submenu to set whether you need enter the password and modified password from the Start page to the Home page. The password is only limited to digits whose number is at least 4, English letters are not allowed.

When you forgot the password, click **Forgot passkey** under the **Enter passkey** page to enter the **Reset passkey** page, enter the **25801379** command with the remote control and click **OK** again, the original password will be invalid after entering it.

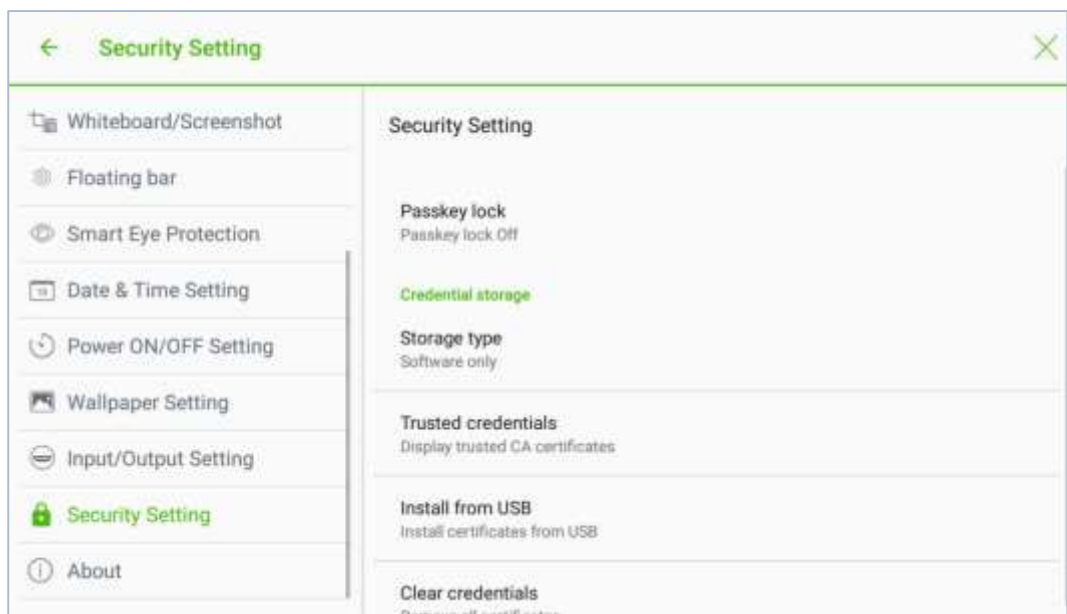

4.3.13 About

Enter the **About** submenu to view firmware or system version information, system upgrade, and factory setting.

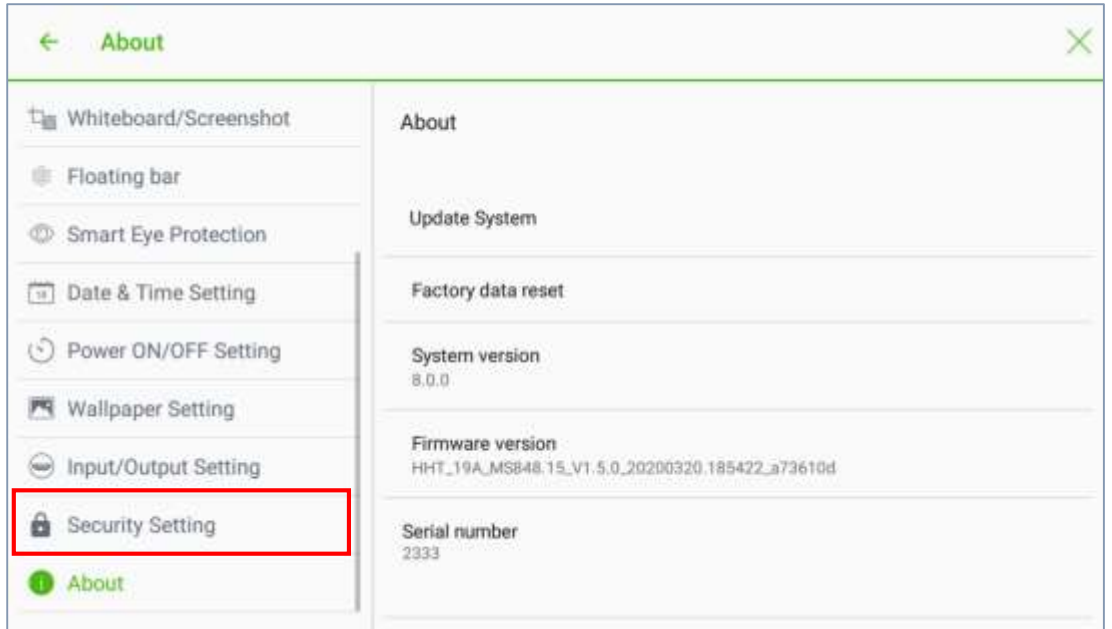

4.4 Built-in PC

On the **Home** page, click **Built-in PC** to enter the Internal PC source page, as shown in the following figure. If the screen is not equipped with an internal PC, "**No Signal**" is displayed.



4.5 Source

On the **Home** page, click **Source** to enter the signal sources, including Built-in PC, HDMI Front, HDMI Rear (1 to 2), DisplayPort, and VGA.

The icon without signal source connected is gray, and the icon with signal source connected is white, and the icon of the signal source being previewed is blue. After you choose white icon, the content of the signal source can be displayed in the above preview window for real-time preview, the icon color changes from white to blue, and the name of the preview window for the signal source changes with the signal source previewed.

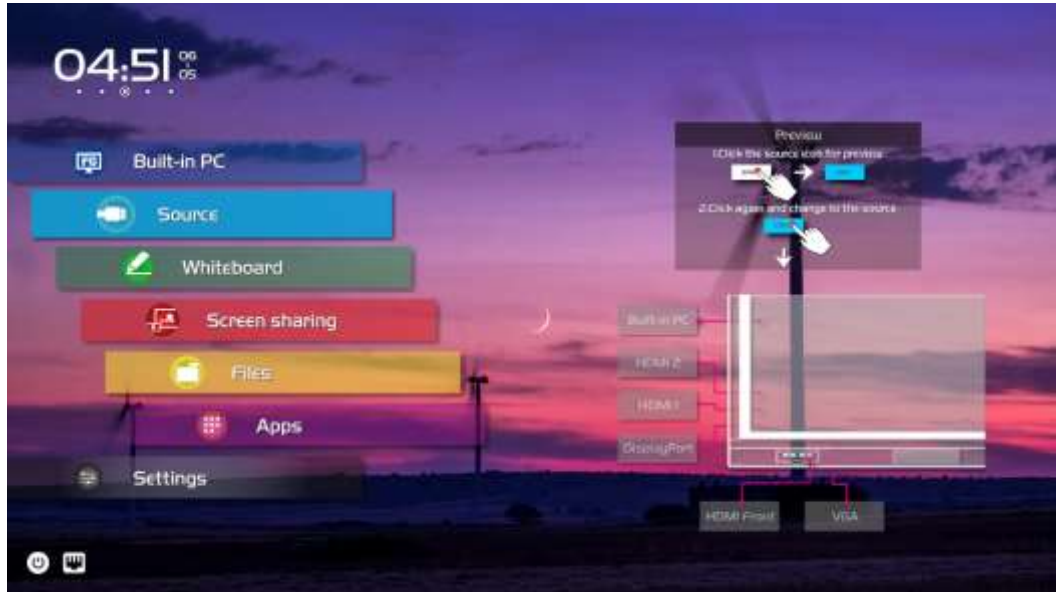

4.6 Whiteboard

The whiteboard has the following functions:

- **Discussion and screen annotation**

On the whiteboard page, you can select pen type, width, and color to write or annotate on the screen. You can also erase selected content or clear all contents.

- **Page navigation**

Preview, share or delete pages.

Whiteboard Mode

- Click **Whiteboard** in the **Home** page or click  in the floating toolbar to enter the discussion mode, as shown in the following figure.

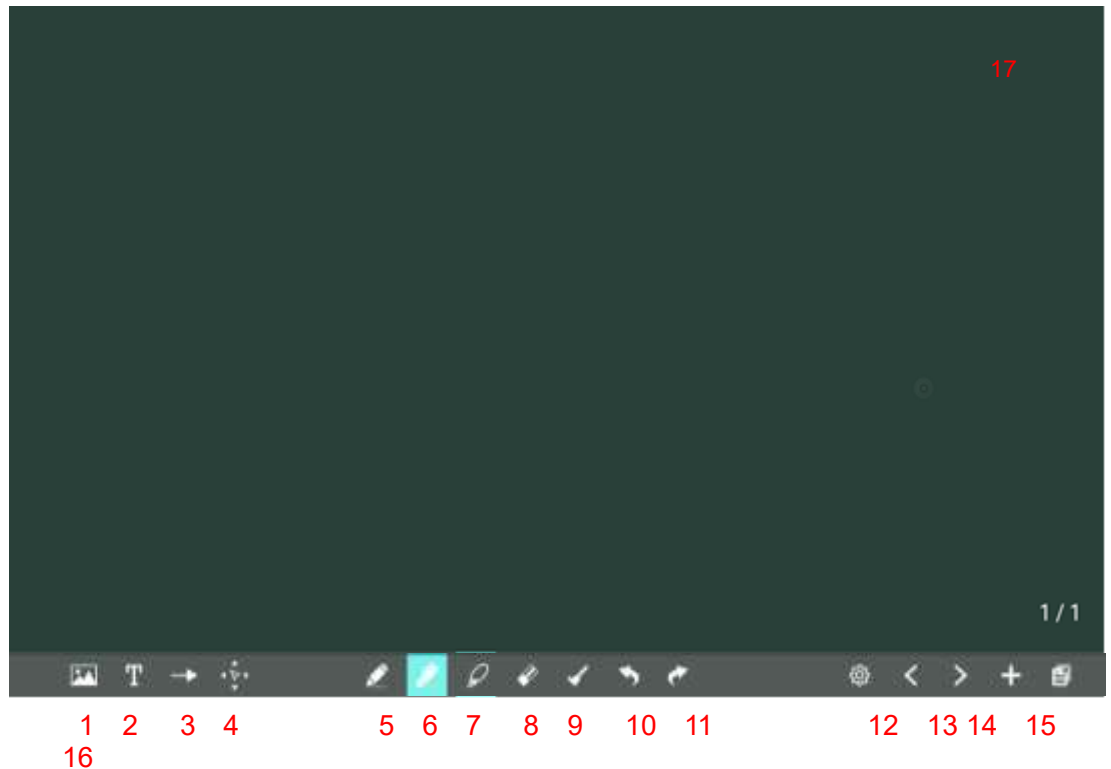

- Click  in the floating toolbar to enter the annotation. In the annotation mode it would generate a transparent layer above the screen, and users can add the annotation on it until they exit the annotation mode.

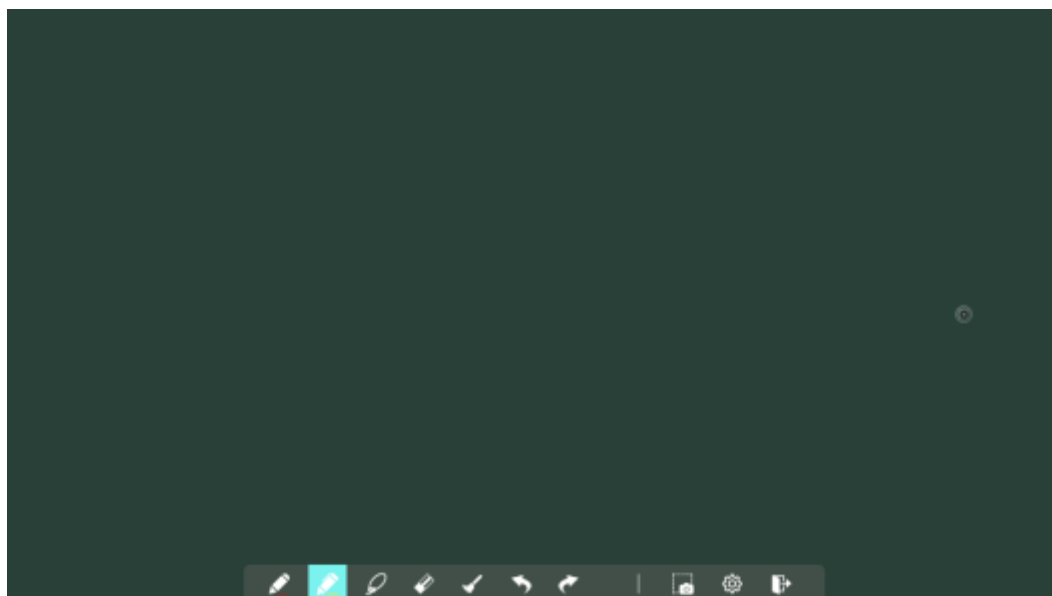

18 19

SN	Icon Name	Icon Function
1	Import	Click to import data from file management, user could import the pictures/ whiteboard data(PNG)/ screenshots(PNG) from system files or USB.
2	Text	Click to insert text, and show the keyboard. (Default is Roboto , 40pt) Click and hold the icon for two seconds to set the default text setting.
3	Auto shape	Click to insert the auto shape. Click and hold the icon for two seconds to set the shapes and color.
4	Move Canvas	Click and move in the page to move canvas and content on it.
5	Pen	Click to use the pen function, and the icon turns into blue. Click and hold the icon for two seconds to set the size or color. And the chosen color and the size would be shown by the icon.
6	Highlighter	Click to use the highlighter function, and the icon turns into blue. Click and hold the icon for two seconds to set the size or color. And the chosen color and the size would be shown by the icon.
7	Select	Click it and user could choose the data on the page to move/ zoom in/ zoom out/ rotate by two fingers, and the icon turns into white.
8	Eraser	Click to select the eraser function, when it is selected, the icon turns into blue.
9	Clear	Clear all data in this page.
10	Undo	Back to the previous step.
11	Next	Turn to the next step.
12	Object recognition switch	Click to change the object recognition setting, slide to left to open the object recognition function, slide to right to turn it off.

SN	Icon Name	Icon Function
13	Previous Page	Click to return to the previous page.
14	Next Page	Click to go to the next page.
15	New Page	Click to add a new page. Click and hold for two seconds to set the color and the pattern of the new page.
16	Navigation	Click to show the page thumbnails.
17	Page Number	Show which page is used right now.
18	Screenshot	Click to take a screen shot, and save the picture to the file management.
19	Exit	Click to exit the annotation mode.

4.6.1 Whiteboard Functions

New Page and Settings

- Create a new page

In the discussion mode, click  to create a new page. Up to 20 pages can be created. See the following figure.

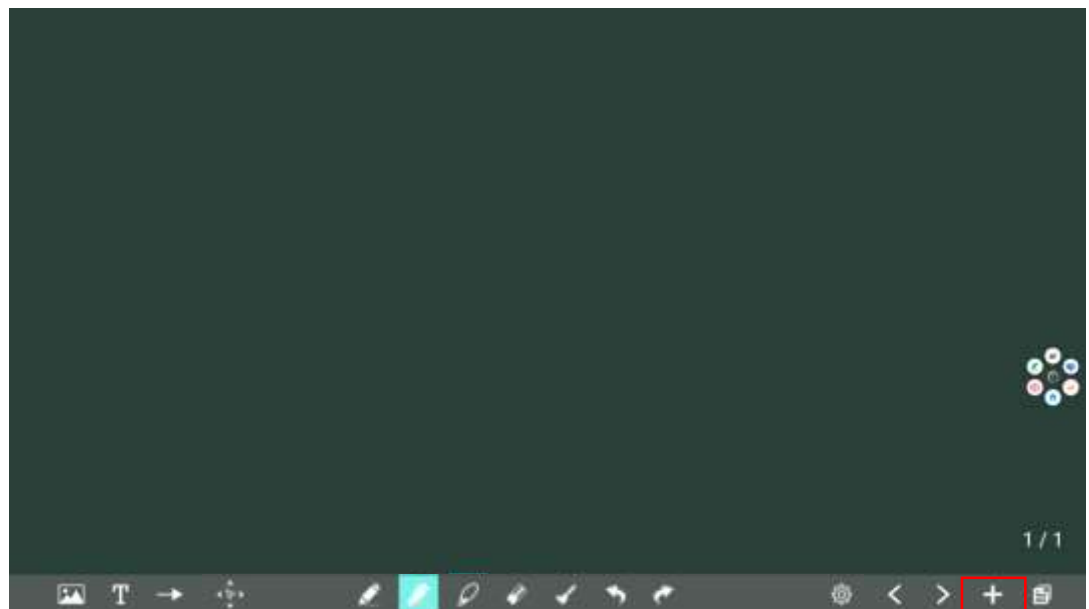

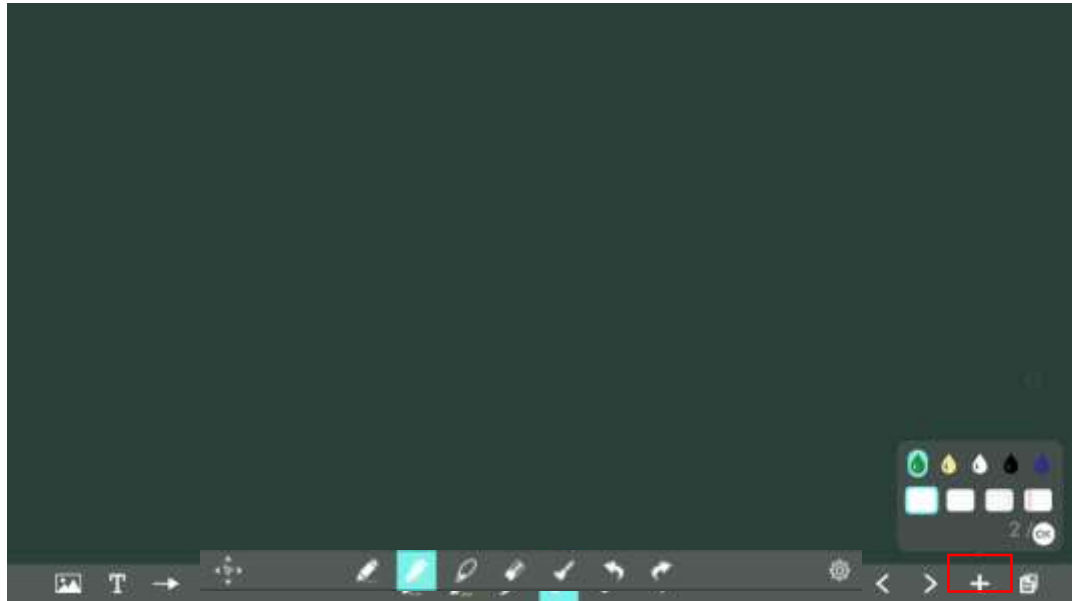

- Page settings

Click and hold  for two seconds to set the color and pattern of the new page, as shown in the figure below.





Pen Type

On the Whiteboard, two types of pens are supported: Pen and highlighter.

- Pen  : used to write.
- Highlighter  : used to highlight. Characters covered by comments are visible.

Line Size and Color

On the Whiteboard, click and hold  or  for two seconds to set the size and color. You can select the line size and color for writing, as shown in the following figure.

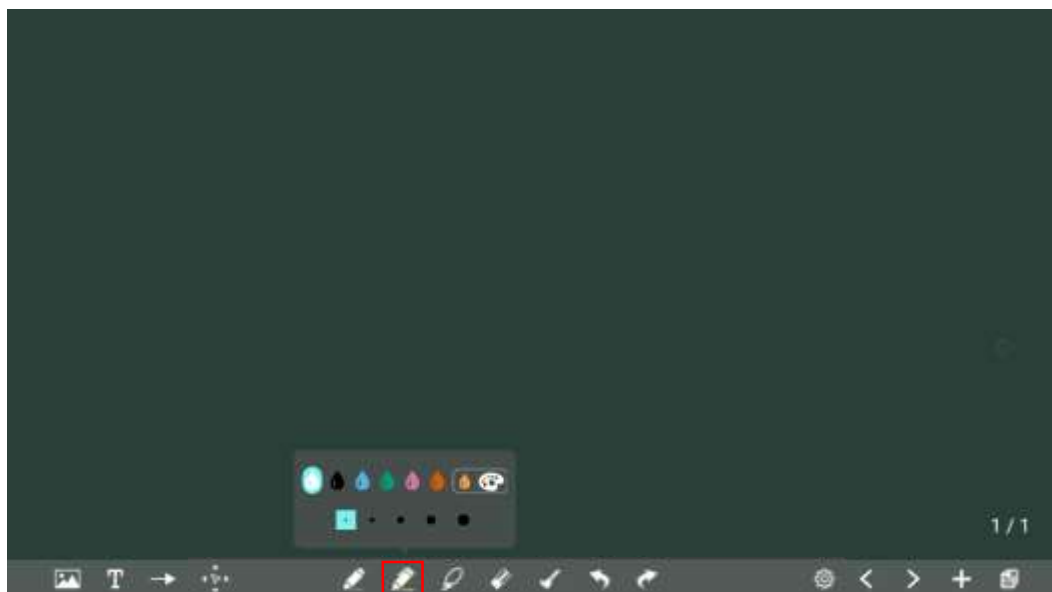

Import

On the Whiteboard, Click  to import data from file management, you can import the pictures/whiteboard data (PNG)/ screenshots (PNG) from system files or USB storage device.

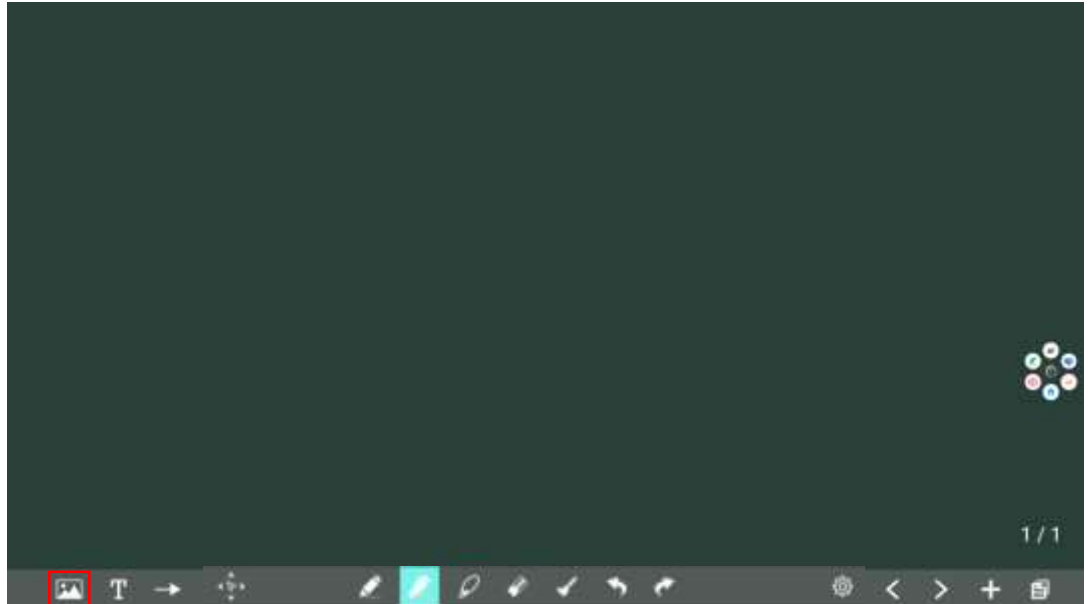

Insert text

On the Whiteboard, Click  to insert text, and show the keyboard. (Default is Roboto, 40pt) Click and hold the icon for two seconds to set the default text setting.

Color: Black/White/Red/Yellow/Green/Blue/Purple (default is White)

Size: 0-100 (click A+ A- to change the font size)

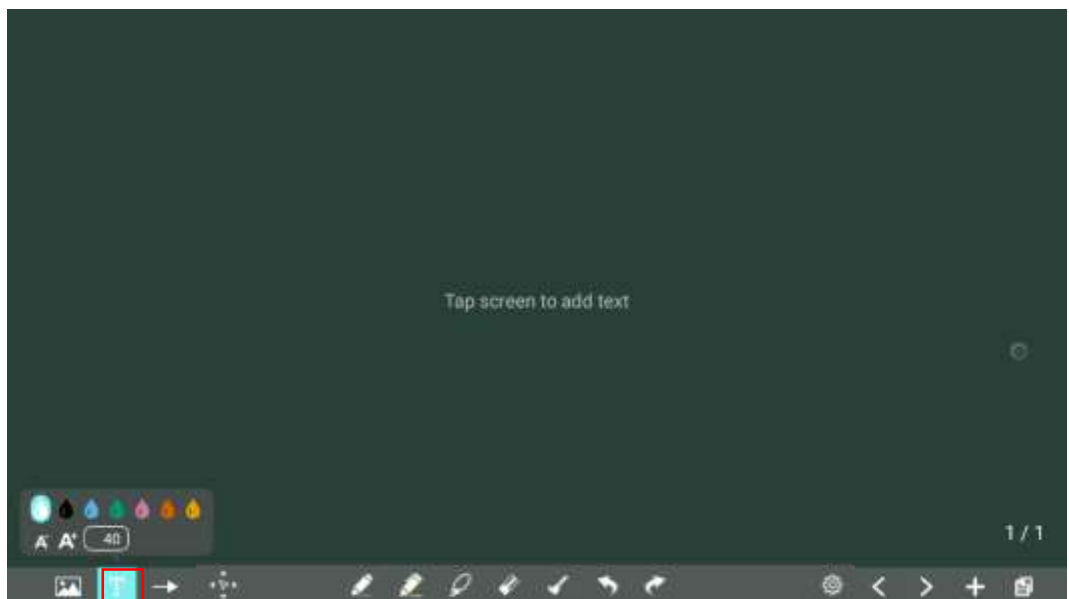



Insert auto shape

On the Whiteboard, Click  to insert the auto shape. Click and hold the icon for two seconds to set the shapes and color.

Shapes: Circular, ellipse, square, equilateral triangle, right triangle, star, arrow, line

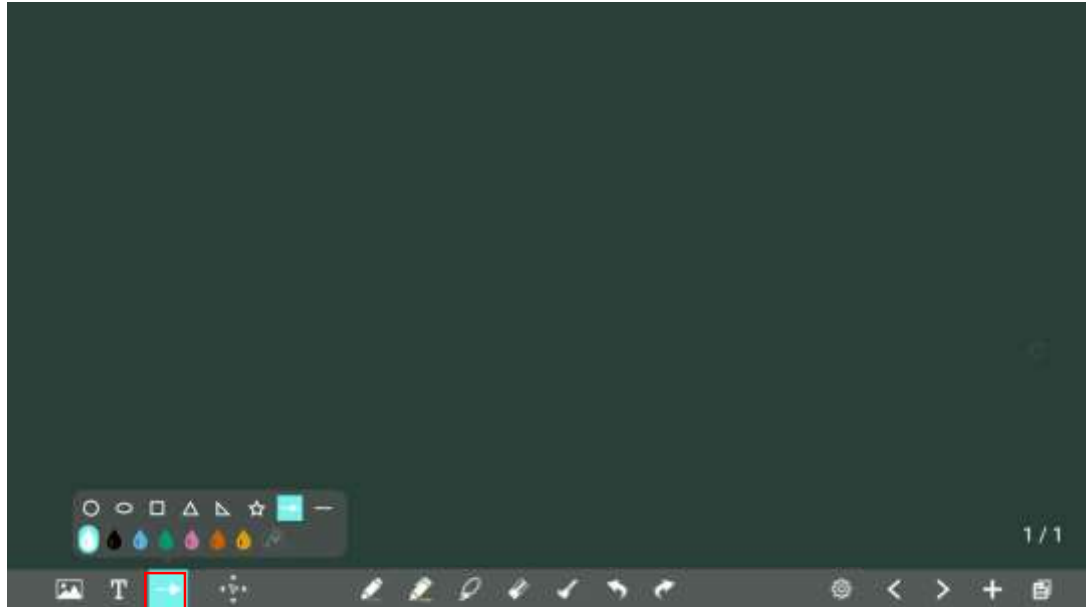
Color: Black/White/Red/Yellow/Green/Blue/Purple (default is White)



The  icon supports three status:

Unavailable: The icon is unavailable when users insert arrow and line;

Unselected: The edge of shapes are colored when the icon is not selected;

Selected: the shape will be filled with colors when you import the shape;

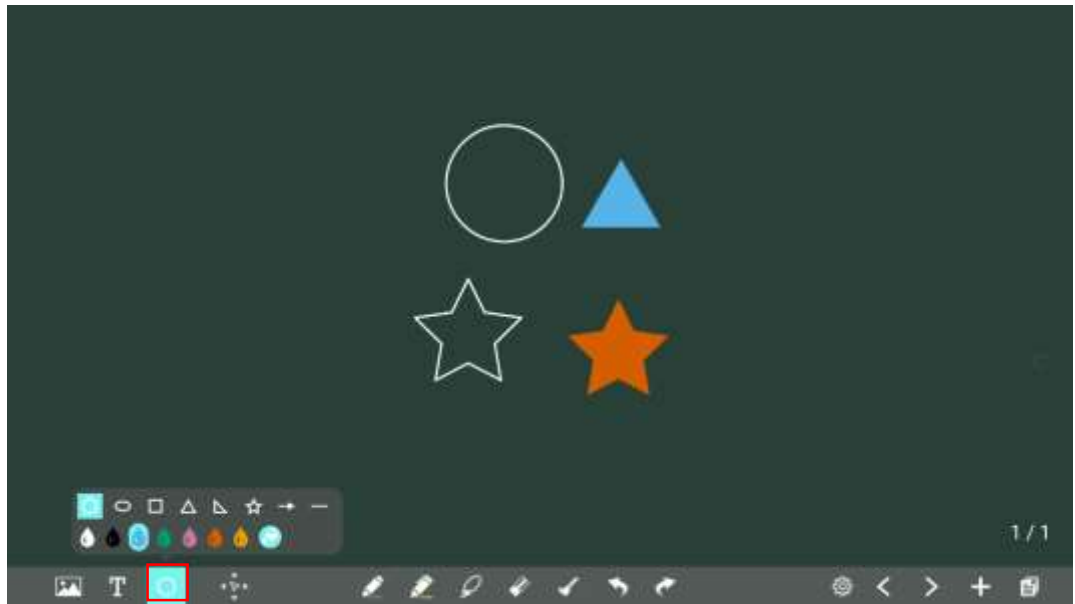



Move canvas

On the whiteboard, Click and move in the page to move canvas and content on it.



Pen Type

On the Whiteboard, two types of pens are supported: Pen and highlighter.

- Pen  : used to write.
- Highlighter  : used to highlight. Characters covered by comments are still visible.

Line Size and Color

On the Whiteboard, click and hold  or  for two seconds to set the size and color. You can select the line size and color for writing, as shown in the following figure:

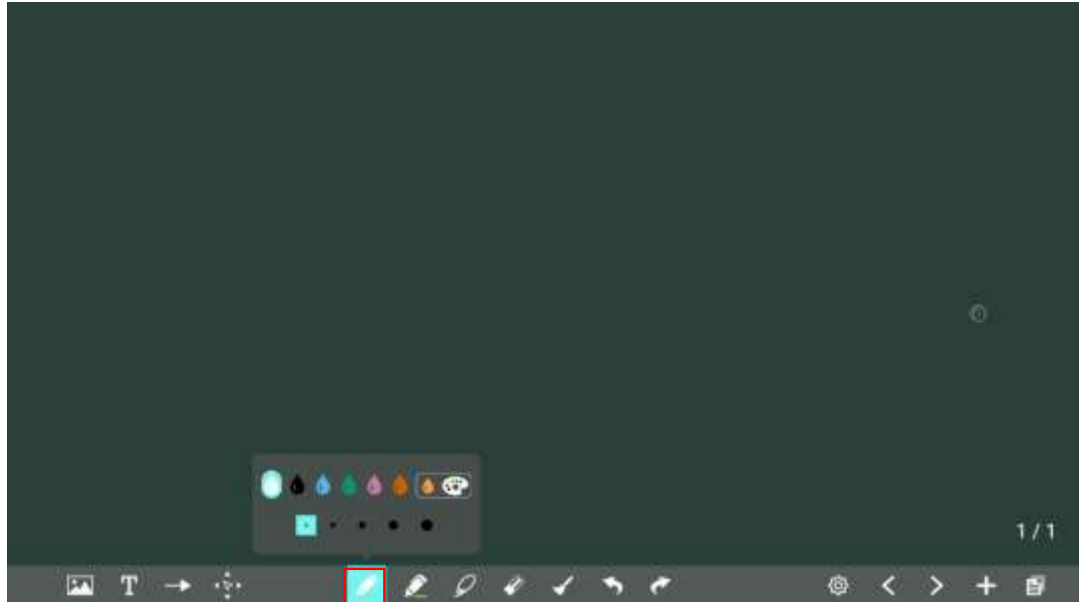

Selected

On the Whiteboard, Click  and user could choose the data on the page to move/ zoom in/ zoom out/ rotate by two fingers, and the icon turns into white.

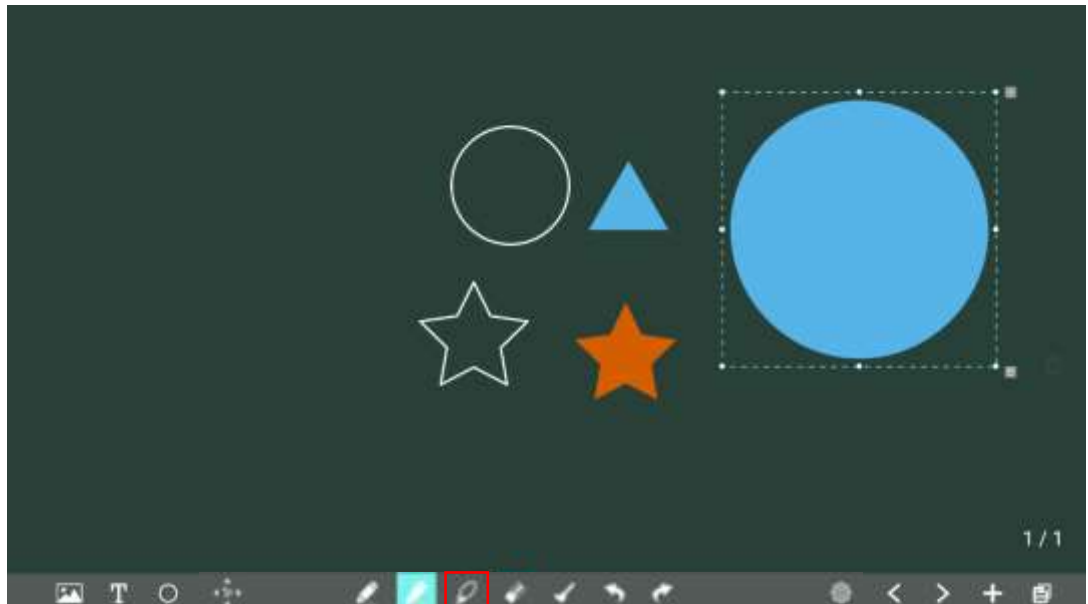

Click  to expand the toolbar which can be used to delete or cut or exit selected the data, such as the following figure:

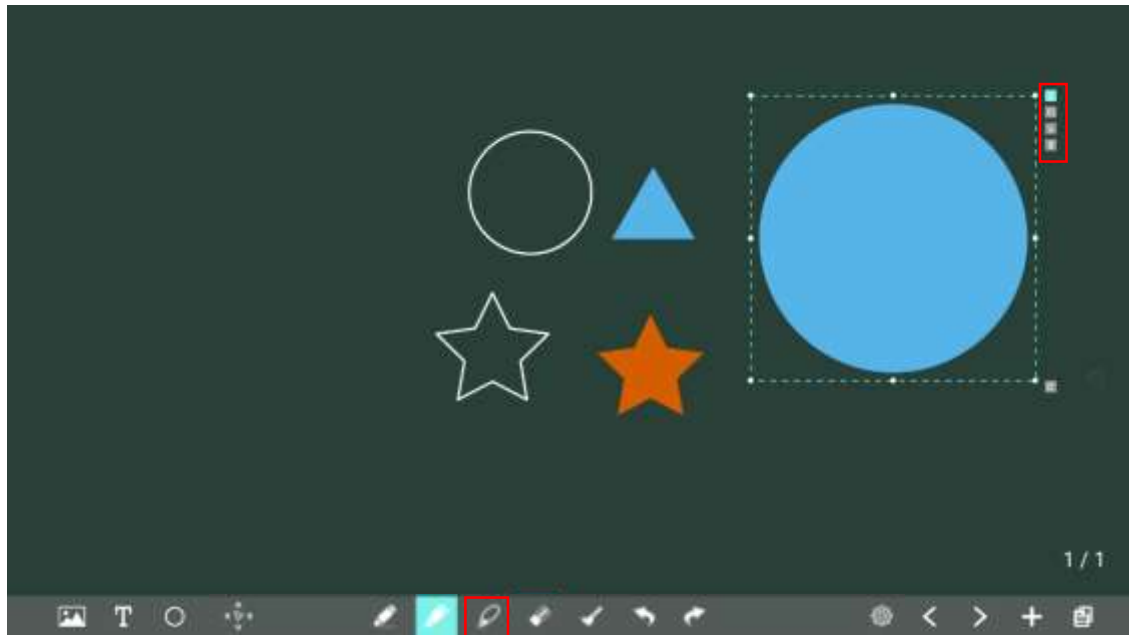

Eraser

Two methods are available to erase written errors or content as follows:

- Spot erasing: Click  to clear wrong or unnecessary content.
- Touch the screen with five fingers simultaneously and the scope of erasing is displayed in size of round. Moving the round can erase the content in the Whiteboard.

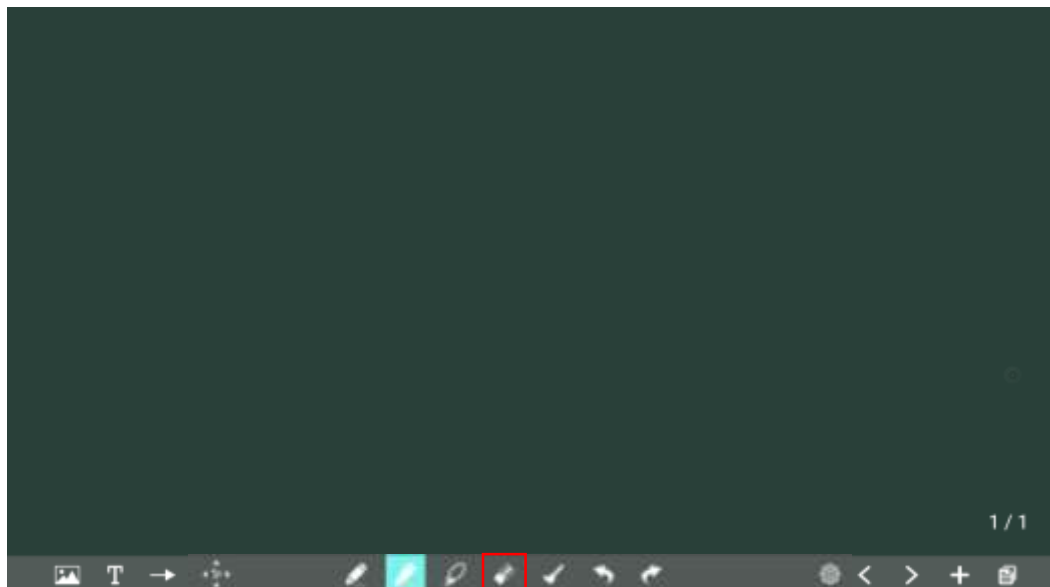

Clear All

On the Whiteboard page, click  to show the pop-up windows to make users choose if they want to clear contents on the current page, as shown in the following figure.

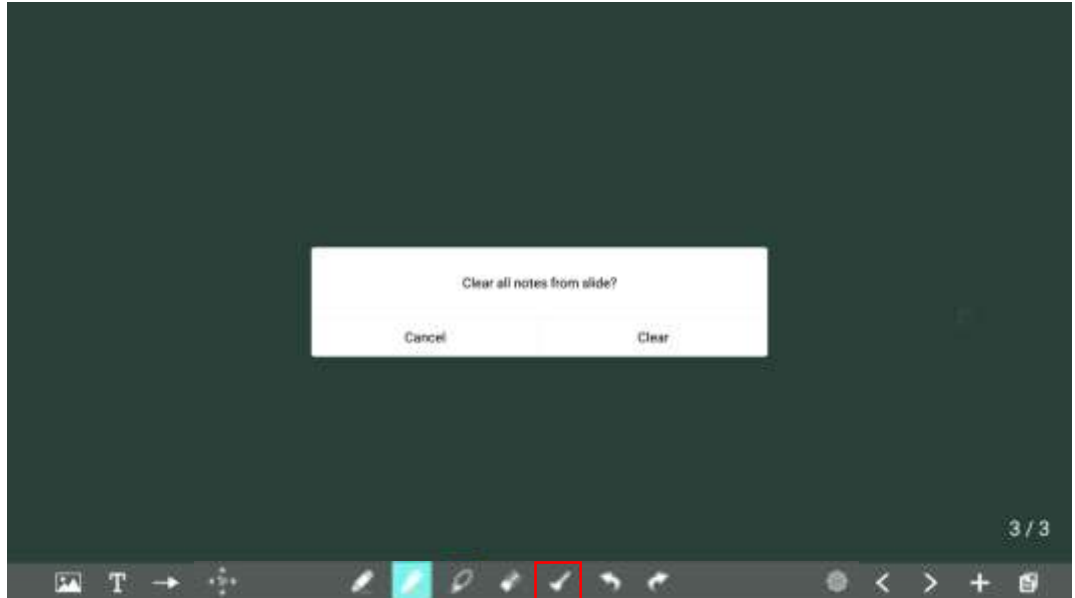

Object Recognition Switch

Press the setting  icon, it will pop up a switch and let user to change the object recognition setting, slide to left to open the object recognition function, slide to right to turn it off.

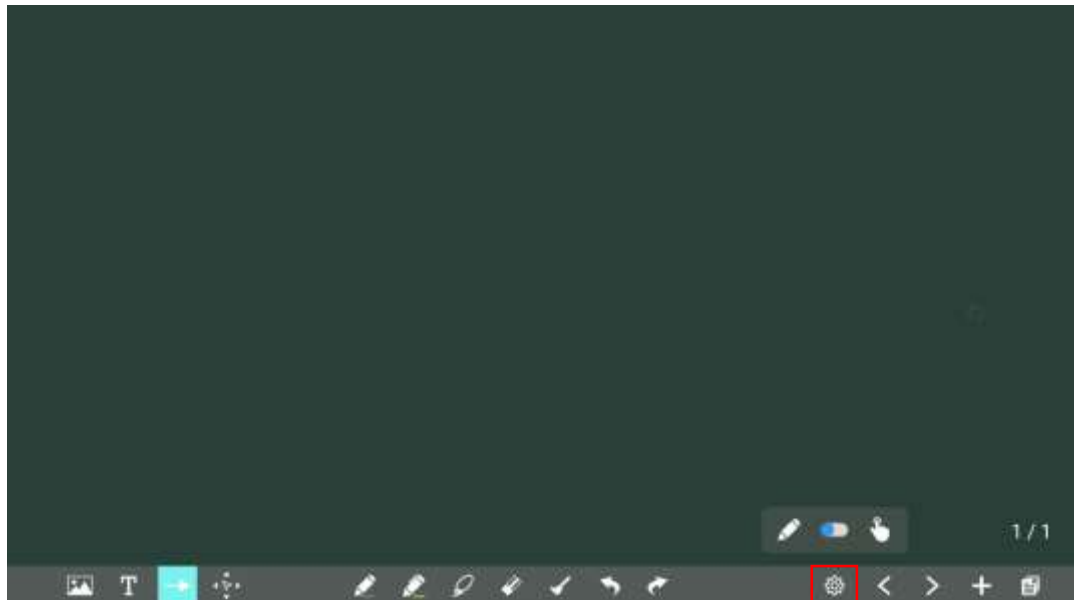

Screenshot

In the annotation mode, click  to save the current image as a picture. Up to 50 screenshots can be created.

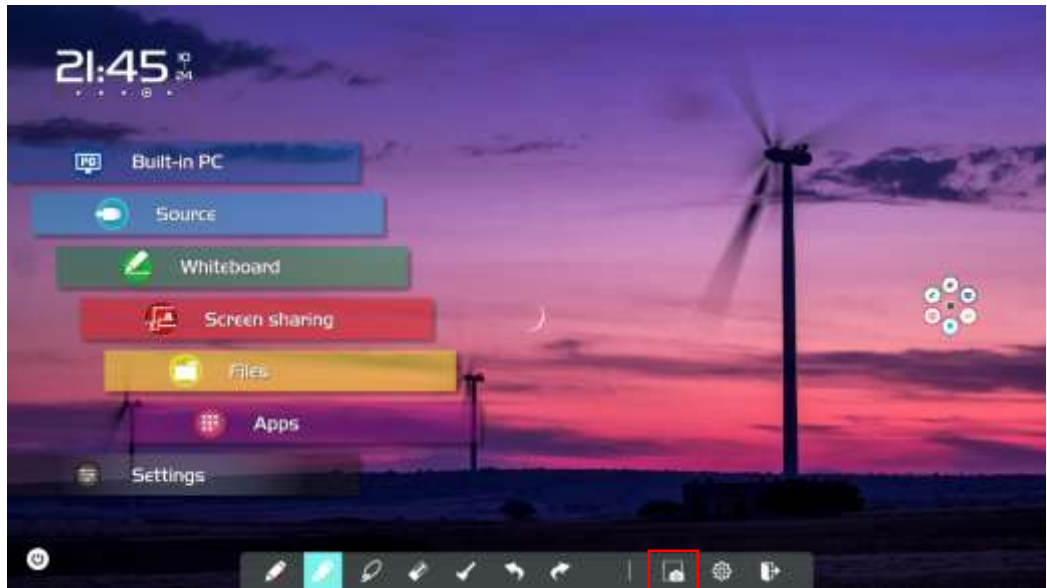

In the Home page, click **Files** or  icon in **Apps**, in the opened File Manager, select "**Internal storage > Pictures > Screenshots > image**" folder to see or get screenshots.

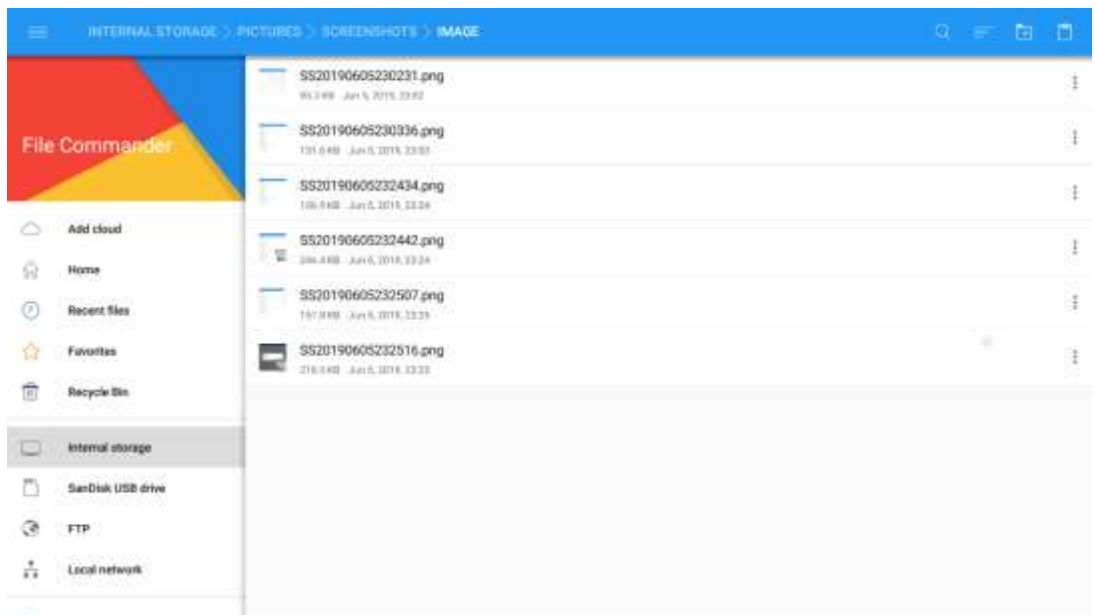

4.6.2 Page Operations

You can preview, select, share, save and delete a created writing page.

Page Preview



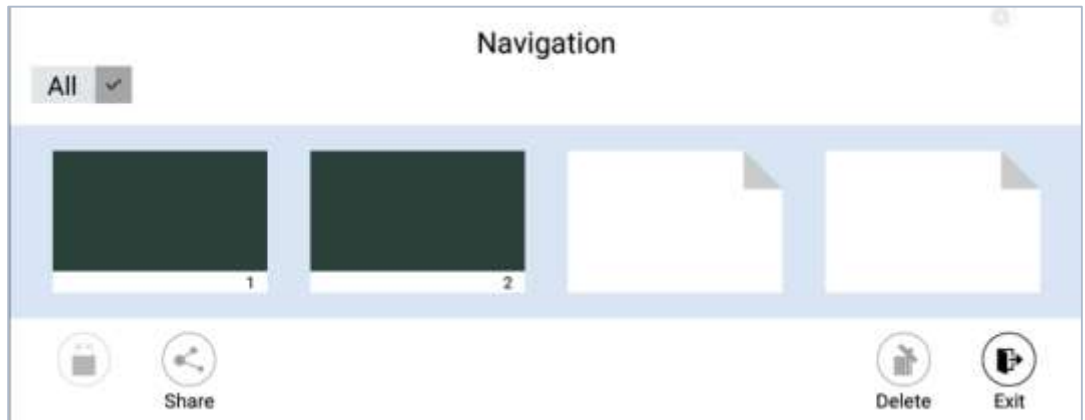

Click  at the lower right corner in the discussion mode. All pages will be displayed. you can slide right or left by one finger to see more.

Click one page to switch to that page for more operations, as shown in the following figure.



Page Selection, Sharing or Deletion

On the **Navigation** page, you can select, share or delete writing pages according to requirements, as shown in the following figure.

- Click  to select all pages.
- Click  to delete selected pages.
- Click  to share selected pages.



Page Saving

On the **Navigation** page, when no external USB flash memories are connected, USB icons will be gray. When an external USB flash memory is connected, USB icons will turn into yellow. Click the yellow USB icons and the selected whiteboard file can be saved in the folder of "Meeting + year month day hour minute second" under the root directory of storage device.

NOTE

- Do not eject USB flash memory before completing the saving process.
- If the USB flash memory is larger than 16GB or the file format is not FAT32, the data will not be saved properly.



4.6.3 Object Detection

This product supports the object detection function and produces different effects according to the diameter and size of the input objects.

- Fist/palm: identified as an eraser.
- Fine Pen (3 mm): suggested to be used during writing.
- Thick Pen (≥ 8 mm)/finger: suggested to be used during the function operation or highlighter operation.
-



 **NOTE**

If the diameter or size of the input object is larger than 3 mm or smaller than 8 mm, there is a risk of identification failure. You are advised to keep the object vertically to write.

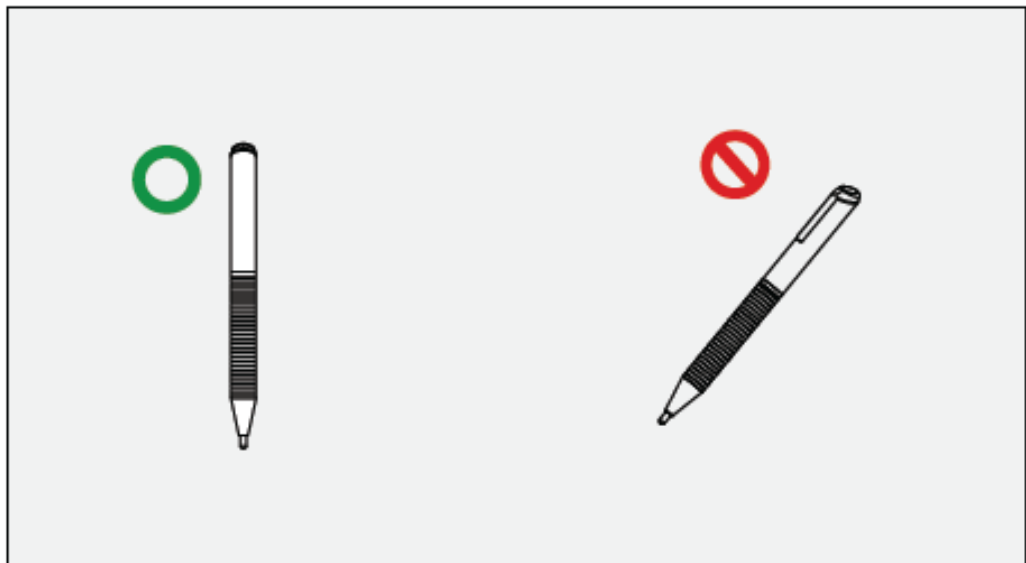

Operation method: The system automatically remembers the settings of fine pen and thick pen. Users can use a fine pen or thick pen (finger) to select functions (including color and thickness). After that, the system remembers the attributes of corresponding functions until users change them manually.

- Fist/palm: keep the eraser function.
- Fine pen (3 mm): before users manually change, the system remembers the previous selected attributes (including color and thickness).
- Thick pen (≥ 8 mm): before users manually change, the system remembers the previous selected attributes (including color and thickness).

4.7 Screen Sharing

Multisystem device is supported to be cast wirelessly to the Touch Screen in different modes (Airplay, Google Cast and MirorOp).

Cast method: In the Home page, click the **Screen Sharing** page to enter operation guideline for wireless cast, and carry out network connection, device search and cast operation successively according to the operation guideline, as shown in the following figure.



4.8 File Management

The product supports connection to USB flash memory. Enter the File Viewer application, you can preview all files in the internal storage and storage devices connected via USB ports and select, copy, paste, delete and search for files.

4.8.1 File Viewer Page

On the **Home** page, click **Files** to enter the File Viewer application, as shown in the following figure.

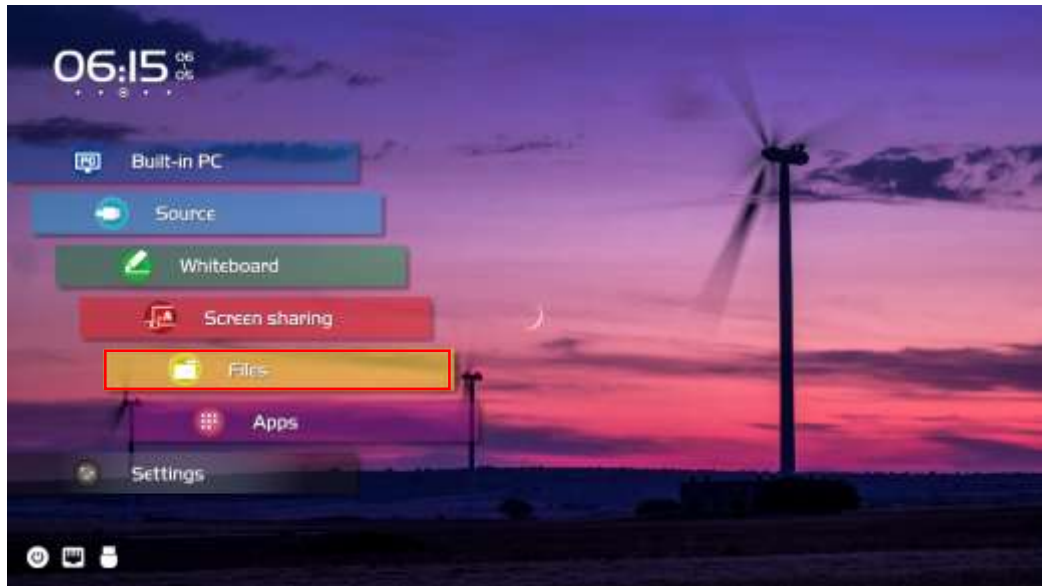

4.8.2 File Preview

Enter the **File** application, you can click the submenu at the left side according to requirements, preview internal storage, external storage devices connected via the USB ports, cloud stored files, FTP uploaded files, and local network files, as shown in the following figure.

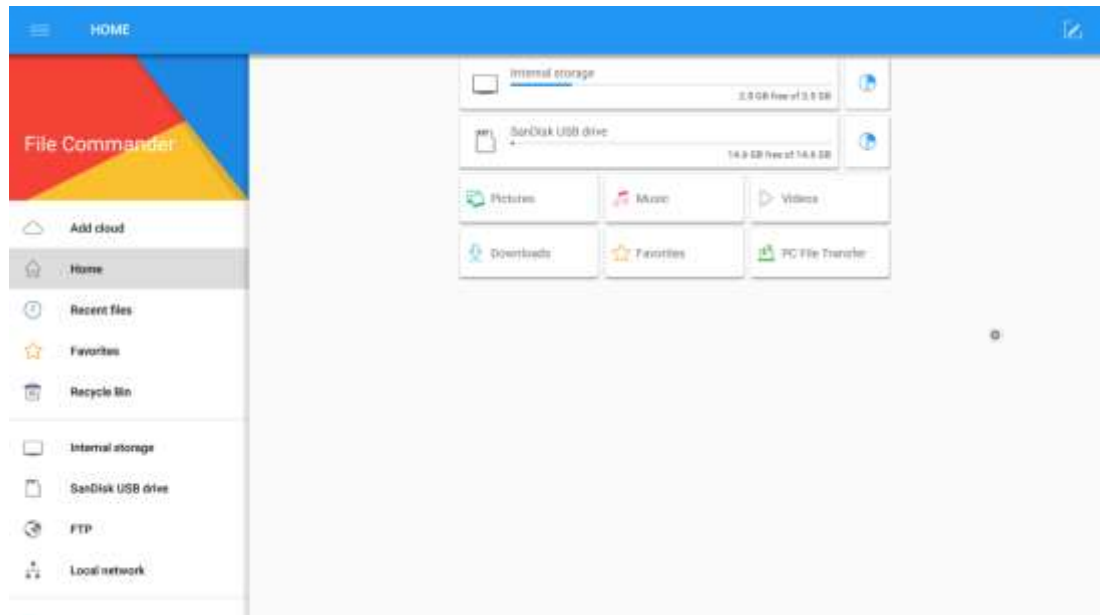

Notes: Users can click the icon at the top right corner to add categories.

4.8.3 File Operation

Enter the **File Viewer** application. You can create folders according to requirements, select files, past files and set wallpaper copy/paste/delete.

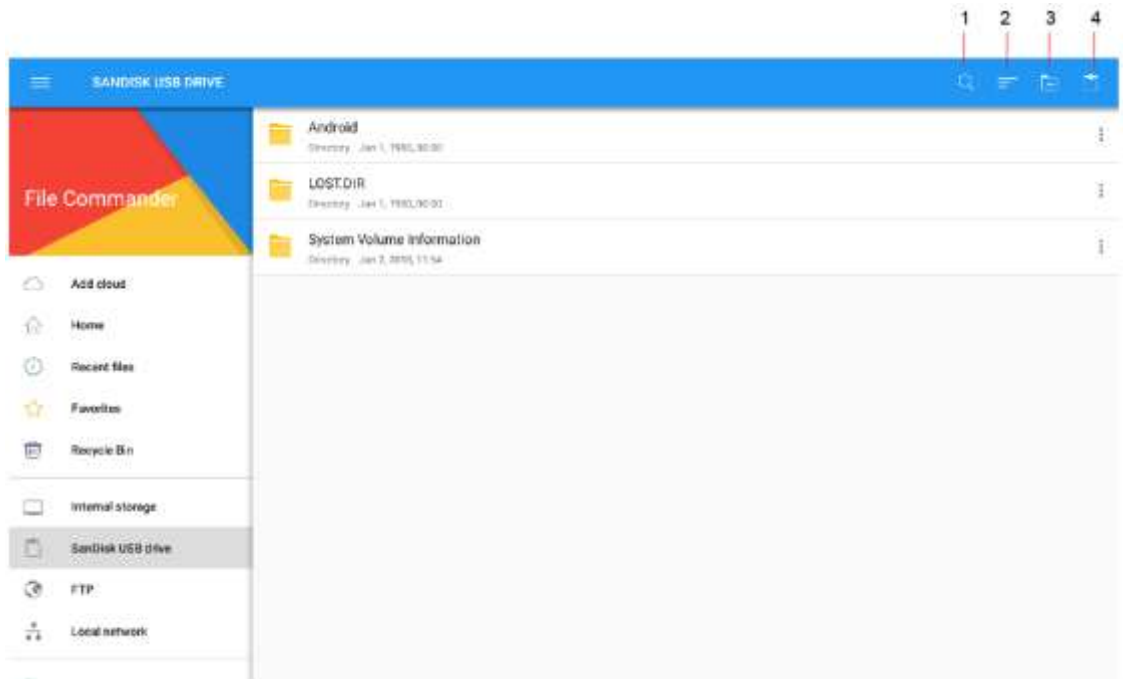

1 Search 2 Filtering 3 New Folder 4 Paste

For details on other operations, click  in the upper right corner for more operations.

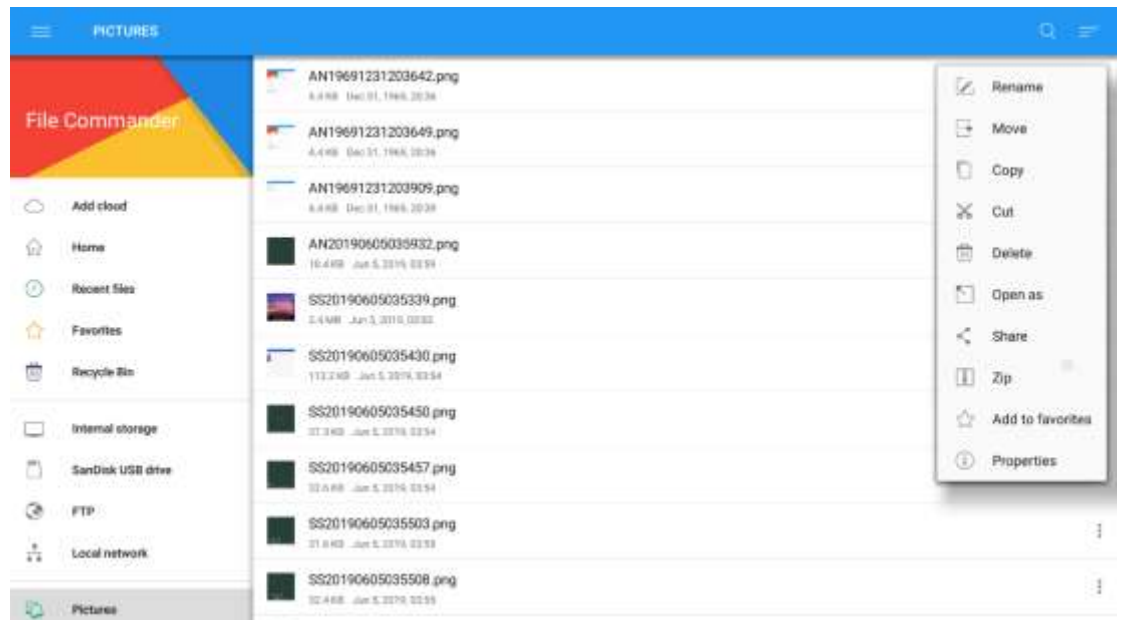

4.8.4 File Search

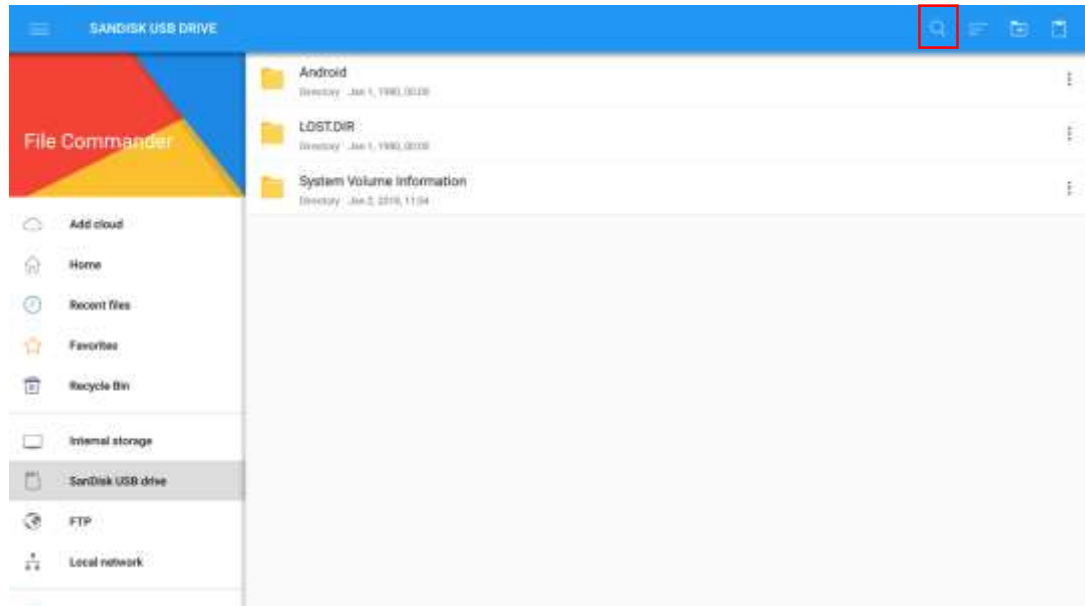

Enter the **File Viewer** application, and click . In the dialog box that is displayed, enter keywords in the search box according to requirements. The system will display a list of files that match the keywords.

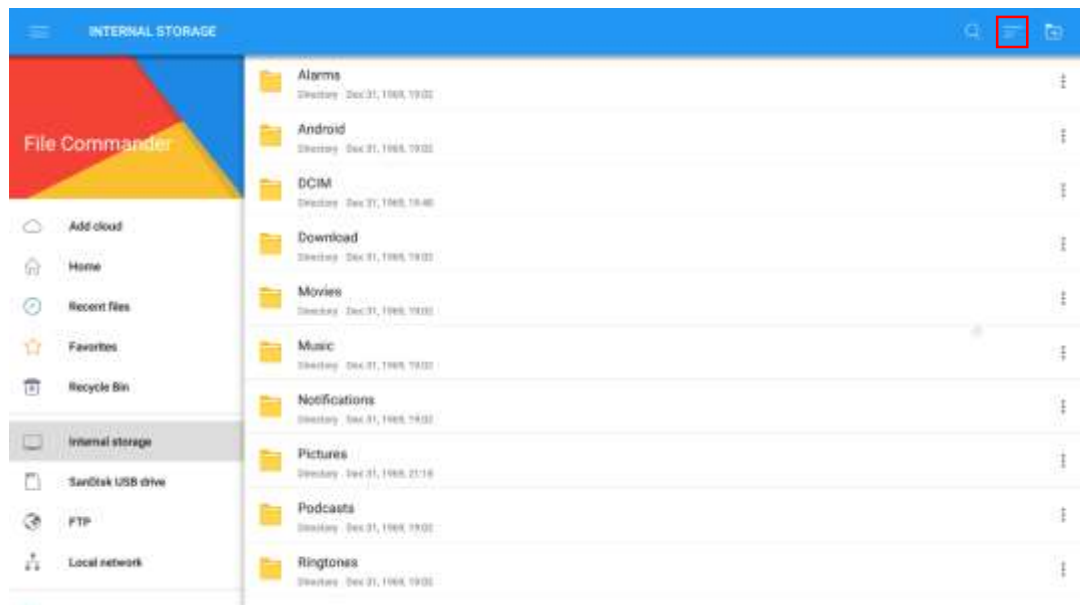

4.8.5 File Filtering

You can click the menu at the left side to display files by type, for example, document, picture, music, video, archive and the downloaded. You can also click  to filter files by picture, music and video.



- The system supports two view modes: list and thumbnail. You can click  and  at the top right corner to switch view modes.
- Click the icon to display files based on name, type, size, and modification. You can also change the display to filter files by whether they are pictures, music or video files, as shown in the following figure.

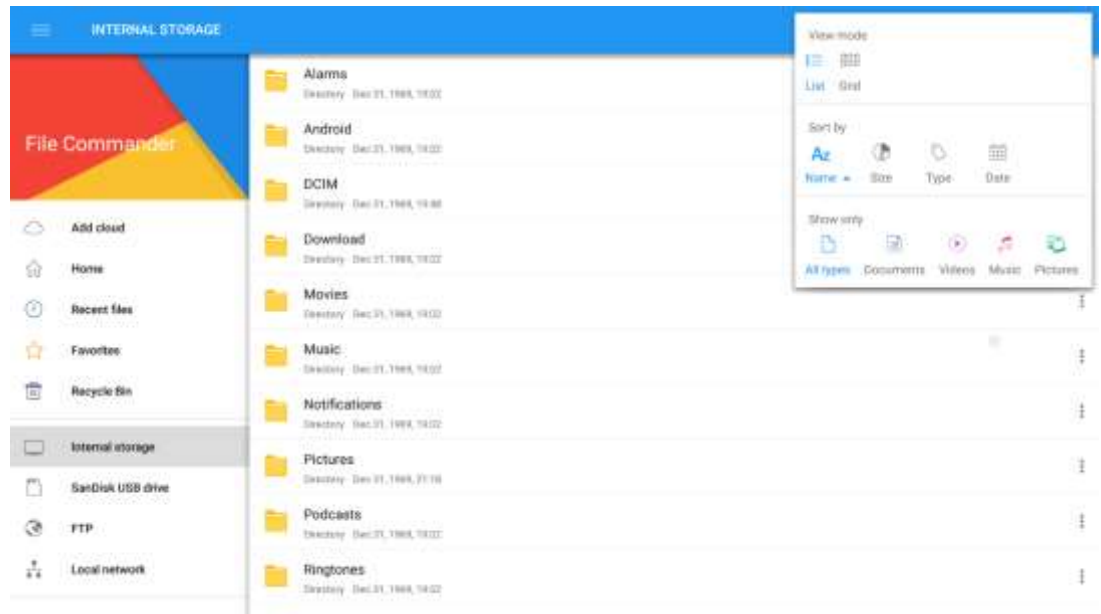

4.8.6 New Folder

Enter the **File Viewer** application, and click  to create folder. As shown in the following figure.

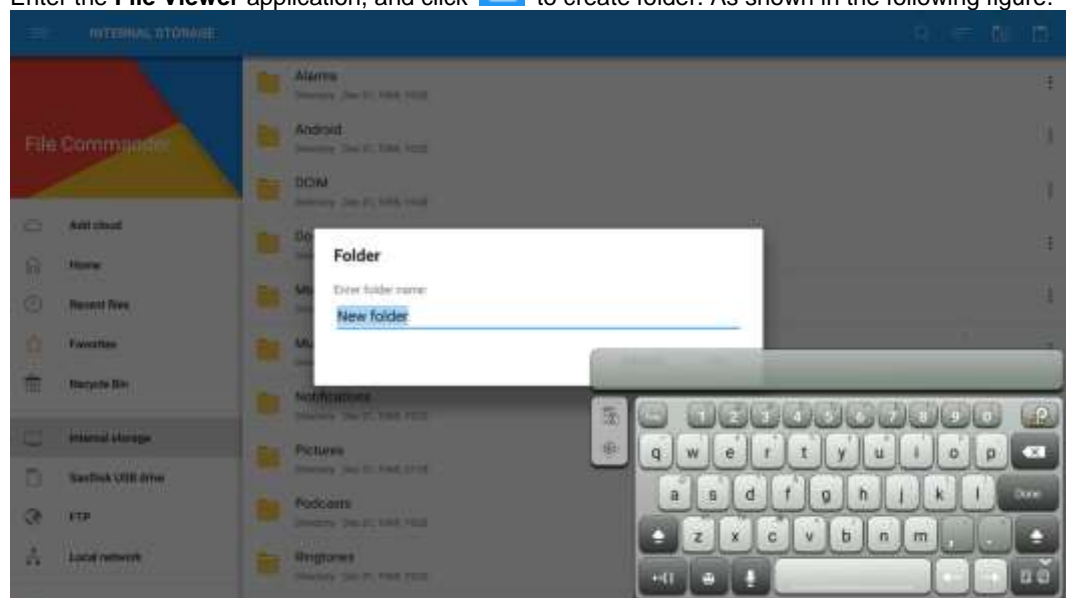

4.8.7 File Name

Under the "**Internal storage > Pictures > Screenshots > image**" folder in the File Manager, all pictures of this meeting are saved. Screenshots include annotation page screenshots, remote control screenshots and pages in the discussion mode. Depending on the screenshots mode, picture naming is different. Picture files are named in the following of prefix + creation file.

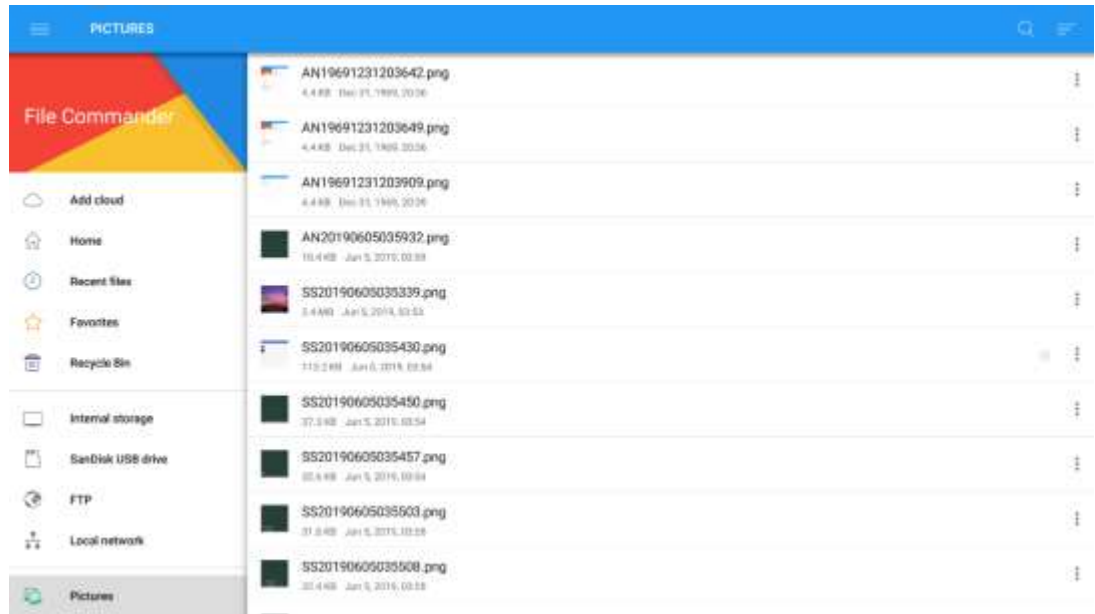

Prefix name rule: WB (discussion mode page), AN (annotation page screenshot), and SS (remote control screenshot).



4.9 Apps

On the **Home** page, click **Apps**. On the page that is displayed, all applications can be viewed. The following figure shows applications that the system is delivered with.



Icon	Function
	Click this icon to enter the browser application.
	Click this icon to enter the chromium application.
	Click this icon to enter the interface for calculator.
	Click this icon to enter the vote application.
	Click this icon to enter the Trucast Express application to implement Screen Sharing function.
	Click this icon to open the File Manager, and you can explore on internal and external files of the screen.
	Click this icon to enter the Office viewer application. In this application, you can view office files.
	Click this icon to enter the email application and send files. Before sending files, you need to create an email account.

4.10 Automatically End Meeting

If the screen is left un-operated for a specified duration, it will be locked to guarantee your privacy. Choose **Settings > Power ON/OFF Setting** to set the duration. For details on the setting method, see "**Power ON/OFF Setting**".



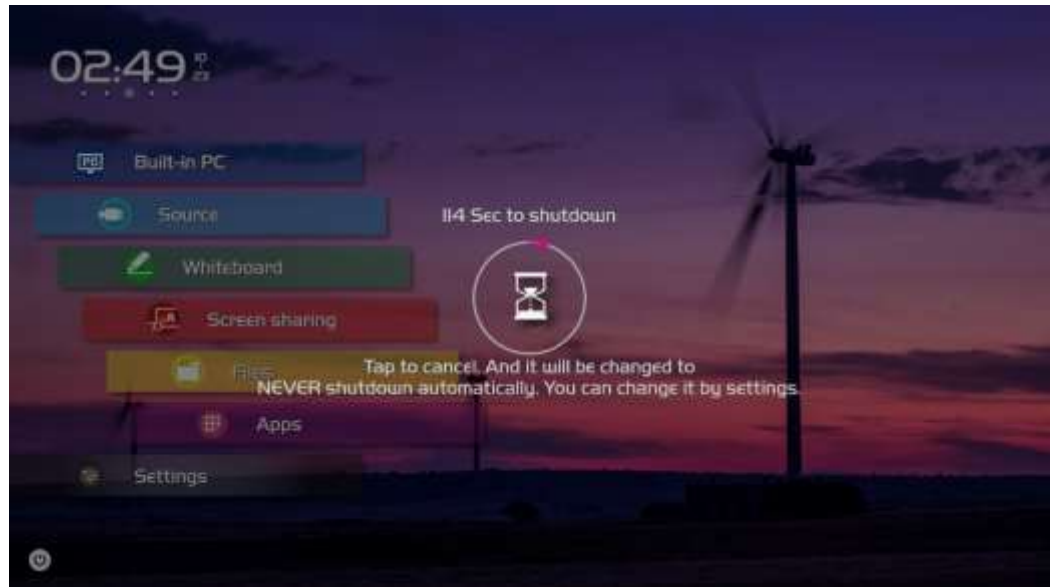



After the screen is locked, if it is operated again within 120 seconds, the screen is unlocked. Otherwise, the screen enters the power off mode.







5 Quick Setting Menu

Using two fingers to swipe up from the bottom of the screen, the quick setting menu will show up, as shown in the following figure.



Icon	Function
	Drag the slider to adjust the brightness.
	Drag the slider to adjust the volume.
	Click the icon to mute/unmute.
	Click the icon to enable the sound only mode.
	Click the icon to return to the Home page.
	Click the icon to enter the annotation mode.
	Click the icon to enter the whiteboard page.

Icon	Function
	Click to enter the internal PC source page.
	Click to enter managing currently running applications.
	Click the icon to freeze the current screen, click again to exit the freeze function.
	Click the icon to enter the settings page.



6 Serial Port Control



Connect RS-232 port to the PC or controlling product. Enable RS-232 serial port connection and complete the following configuration.



Port: COM1 (Set according to PC or controlling product's port number)			
Baud rate	19200	Odd/even check	None
Data bits	8	Stop bit	1





The following tables list controlling codes, querying codes and return codes.



Function	Controlling Code	Return Code
Power on	7F 08 99 A2 B3 C4 02 FF 01 00 CF	7F 09 99 A2 B3 C4 02 FF 01 00 01 CF
Power off	7F 08 99 A2 B3 C4 02 FF 01 01 CF	7F 09 99 A2 B3 C4 02 FF 01 01 01 CF
Mute/Unmute	7F 08 99 A2 B3 C4 02 FF 01 02 CF	7F 09 99 A2 B3 C4 02 FF 01 02 01 CF
Signal source	7F 08 99 A2 B3 C4 02 FF 01 06 CF	7F 09 99 A2 B3 C4 02 FF 01 06 01 CF
Enable whiteboard	7F 08 99 A2 B3 C4 02 FF 01 07 CF	7F 09 99 A2 B3 C4 02 FF 01 07 01 CF
Display status	7F 08 99 A2 B3 C4 02 FF 01 09 CF	7F 09 99 A2 B3 C4 02 FF 01 09 01 CF
HDMI front	7F 08 99 A2 B3 C4 02 FF 01 0A CF	7F 09 99 A2 B3 C4 02 FF 01 0A 01 CF
HDMI rear 1	7F 08 99 A2 B3 C4 02 FF 01 52 CF	7F 09 99 A2 B3 C4 02 FF 01 52 01 CF
HDMI rear 2	7F 08 99 A2 B3 C4 02 FF 01 53 CF	7F 09 99 A2 B3 C4 02 FF 01 53 01 CF
VGA	7F 08 99 A2 B3 C4 02 FF 01 54 CF	7F 09 99 A2 B3 C4 02 FF 01 54 01 CF
Internal PC	7F 08 99 A2 B3 C4 02 FF 01 38 CF	7F 09 99 A2 B3 C4 02 FF 01 38 01 CF
DP	7F 08 99 A2 B3 C4 02 FF 01 56 CF	7F 09 99 A2 B3 C4 02 FF 01 56 01 CF

Function	Controlling Code	Return Code
VOL -	7F 08 99 A2 B3 C4 02 FF 01 17 CF	7F 09 99 A2 B3 C4 02 FF 01 17 01 CF
VOL +	7F 08 99 A2 B3 C4 02 FF 01 18 CF	7F 09 99 A2 B3 C4 02 FF 01 18 01 CF
Menu	7F 08 99 A2 B3 C4 02 FF 01 1B CF	7F 09 99 A2 B3 C4 02 FF 01 1B 01 CF
Home page	7F 08 99 A2 B3 C4 02 FF 01 1C CF	7F 09 99 A2 B3 C4 02 FF 01 1C 01 CF
Return (exit)	7F 08 99 A2 B3 C4 02 FF 01 1D CF	7F 09 99 A2 B3 C4 02 FF 01 1D 01 CF
OK	7F 08 99 A2 B3 C4 02 FF 01 2B CF	7F 09 99 A2 B3 C4 02 FF 01 2B 01 CF
←	7F 08 99 A2 B3 C4 02 FF 01 2C CF	7F 09 99 A2 B3 C4 02 FF 01 2C 01 CF
→	7F 08 99 A2 B3 C4 02 FF 01 2D CF	7F 09 99 A2 B3 C4 02 FF 01 2D 01 CF
↑	7F 08 99 A2 B3 C4 02 FF 01 2E CF	7F 09 99 A2 B3 C4 02 FF 01 2E 01 CF
↓	7F 08 99 A2 B3 C4 02 FF 01 2F CF	7F 09 99 A2 B3 C4 02 FF 01 2F 01 CF
Set volume	7F 08 99 A2 B3 C4 02 FF 05 XX CF  NOTE XX indicates the volume value (0 to 100), corresponding to hexadecimals 00 to 64.	7F 09 99 A2 B3 C4 02 FF 05 XX 01 CF
Query the firmware version number	7F 08 99 A2 B3 C4 02 FF 01 3D CF	7F 09 99 A2 B3 C4 02 FF 01 3D 01 CF
Enable the comment function	7F 08 99 A2 B3 C4 02 FF 01 40 CF	7F 09 99 A2 B3 C4 02 FF 01 40 01 CF
Set display mode	7F 08 99 A2 B3 C4 02 FF 06 XX CF  NOTE <ul style="list-style-type: none"> • XX = 00 indicates the Standard mode. • XX = 01 indicates the ECO mode. • XX = 02 indicates the Auto mode. 	7F 09 99 A2 B3 C4 02 FF 06 XX 01 CF
Increase backlight brightness	7F 08 99 A2 B3 C4 02 FF 01 47 CF	7F 09 99 A2 B3 C4 02 FF 01 47 01 CF

Function	Controlling Code	Return Code
Decrease backlight brightness	7F 08 99 A2 B3 C4 02 FF 01 48 CF	7F 09 99 A2 B3 C4 02 FF 01 48 01 CF
Set the value of backlight brightness	7F 08 99 A2 B3 C4 02 FF 09 XX CF  NOTE XX indicates the value of backlight brightness (0 - 100), corresponding to the hexadecimal number system (00 - 64).	7F 09 99 A2 B3 C4 02 FF 09 XX 01 CF
Switch backlight	7F 08 99 A2 B3 C4 02 FF 01 15 CF	7F 09 99 A2 B3 C4 02 FF 01 15 XX CF  NOTE <ul style="list-style-type: none"> • XX = 01 indicates the backlight is on. • XX = 00 indicates the backlight is off.
Switch to child safety lock	7F 08 99 A2 B3 C4 02 FF 01 57 CF	7F 09 99 A2 B3 C4 02 FF 01 57 01 CF
Screenshot	7F 08 99 A2 B3 C4 02 FF 01 1F CF	7F 09 99 A2 B3 C4 02 FF 01 1F 01 CF
Settings	7F 08 99 A2 B3 C4 02 FF 01 20 CF	7F 09 99 A2 B3 C4 02 FF 01 20 01 CF

Function	Querying Code	Return Code
Power supply	7F 08 99 A2 B3 C4 02 FF 01 37 CF	7F 09 99 A2 B3 C4 02 FF 01 37 XX CF  NOTE XX indicates the power on/off state. <ul style="list-style-type: none"> • XX = 01: power on state • XX = 00: power off state
Speaker	7F 08 99 A2 B3 C4 02 FF 01 82 CF	7F 08 99 A2 B3 C4 02 FF 01 82 XX CF  NOTE <ul style="list-style-type: none"> • 01: mute • 00: non-mute

Function	Querying Code	Return Code
Current signal source	7F 08 99 A2 B3 C4 02 FF 01 50 CF	7F 09 99 A2 B3 C4 02 FF 01 50 XX CF  NOTE <ul style="list-style-type: none"> • Smart system = 30 • PC = 17 • DP = 20 • VGA = 0 • HDMI rear 1 = 1F • HDMI Rear 2 = 1E • HDMI Front = 19
Speaker volume	7F 08 99 A2 B3 C4 02 FF 01 33 CF	7F 09 99 A2 B3 C4 02 FF 01 33 XX CF  NOTE <i>XX indicates the current volume value (XX is a hexadecimal value, range: 00~64).</i> <i>For example, XX = 20 indicates the current volume value is 32 (decimal value), XX = 00 indicates mute state.</i>
D.Mode	7F 08 99 A2 B3 C4 02 FF 01 35 CF	7F 09 99 A2 B3 C4 02 FF 01 35 XX CF  NOTE <i>XX indicates the mode.</i> <ul style="list-style-type: none"> • XX = 00 indicates the Standard mode. • XX = 01 indicates the ECO mode. • XX = 02 indicates the Auto mode.
Backlight brightness	7F 08 99 A2 B3 C4 02 FF 01 49 CF	7F 09 99 A2 B3 C4 02 FF 01 49 XX CF  NOTE <i>XX indicates the value of backlight brightness (0 - 100), corresponding to the hexadecimal number system (00 - 64).</i>
Backlight status	7F 08 99 A2 B3 C4 02 FF 01 81 CF	7F 08 99 A2 B3 C4 02 FF 01 81 XX CF  NOTE <ul style="list-style-type: none"> • XX = 00 indicates the backlight is on. • XX = 01 indicates the backlight is off.

Function	Querying Code	Return Code
Switch to child safety lock	7F 08 99 A2 B3 C4 02 FF 01 84 CF	7F 08 99 A2 B3 C4 02 FF 01 84 XX CF  NOTE <ul style="list-style-type: none"> • XX = 01 indicates the child safety lock is on. • XX = 00 indicates the child safety lock is off.
Whiteboard state	7F 08 99 A2 B3 C4 02 FF 01 83 CF	7F 08 99 A2 B3 C4 02 FF 01 83 XX CF  NOTE <ul style="list-style-type: none"> • XX = 01 indicates the whiteboard state. • XX = 00 indicates non-whiteboard state.
Return to system state of the previous 9 options	7F 08 99 A2 B3 C4 02 FF 0A 00 CF	7F 08 99 A2 B3 C4 02 FF 0A 00 AB CD EF GH IJ OP QR ST UV CF  NOTE <ul style="list-style-type: none"> • AB: Power supply • CD: Speaker • EF: Current signal source • GH: Speaker volume • IJ: D.Mode • OP: Backlight brightness • QR: Backlight state • ST: Whiteboard state • UV: Switch to child safety lock

7 FAQs & Troubleshooting

Symptom	Troubleshooting Method
The microphone and speaker cannot be used simultaneously.	Choose Control Panel > Sound . In the Playback tab page, disable Speaker .
The screen cannot be powered on or the indicator is off.	Check whether the power supply is connected.
	Check whether the power supply plug is properly connected.
	Check whether the power supply line is properly connected.
	Check whether the rocker switch is enabled.
	Press the reset switch and start the system again.
The remote control is not causing a response.	Replace the batteries.
	Check whether the polarity direction of the batteries is correct.
	Use the remote control aligning with the IR reception window.
The image is normal but there is no sound.	Increase volume on both the screen and the Windows system.
	Check whether the screen and the Windows system are muted.
	If an external computer is connected, check whether the connection cables are normal.
During the video conference, the remote party cannot hear the sound of the local party.	Check whether the local microphone is muted.
	In Control Panel > Sound , set the product parameters to the default values in the Recording tab page.
The system is automatically powered on/off when no operation is performed.	Disable the automatic power on/off function. For details, see the section "Power ON/OFF Setting".
	Check whether the screen entered the power off mode due to no operation for an extended period of time.
	Check whether the input power supply is stable.

Symptom	Troubleshooting Method
The colors of images are abnormal.	Check whether the HDMI cable is properly connected or has any quality issue.
The touch function is abnormal or the positioning is inaccurate.	Restart the screen.
	In the Windows system, perform positioning again. For details, see the section "Calibration".
The touch function is unavailable when the external signal source channel is being used.	Switch between different external signal sources.
	Ensure that the USB touch cable is connected to the proper port. For details, see the section "Ports".
	Remove and insert the USB touch cable again.
There is no sound when the HDMI in channel is used.	Remove and insert the HDMI cable again.
No image is displayed when the HDMI out channel is used.	Generally, this issue is caused by the compatibility of the external display product. Replace the external display product and test again.
	The HDMI cable is too long or has a poor quality. Replace the HDMI cable delivered with the product.
The touch function on the front panel is ineffective.	Touch the button using the fingertip completely.
	Check whether the finger is wet or has other liquids on it.
	Restart the screen.
The USB flash memory cannot be identified.	Check whether the USB flash memory is inserted into the correct USB port. For details, see the section "Ports".
The conference records cannot be saved on the USB flash memory, and the system prompts "The target storage product has no write permissions".	Format the USB flash memory to the FAT32 format.
The internal PC has no signal.	Check whether the internal PC is properly inserted in the slot.
	Check whether the internal PC enters the power off state.
	Press the power button on the internal PC (for details, see the instructions of the internal PC), and manually start up the internal PC.
In the Windows system, no wireless network can be found or the wireless network signal is weak.	Check whether the Wi-Fi antenna is properly installed for the internal PC.
The keyboard is not correctly displayed.	Confirm that the Hardware is enabled.

Symptom	Troubleshooting Method
<p>When connecting the handheld microphone to the interface on the front panel, the distance from user to microphone should be no less than 1 meter, otherwise it may cause sound to distort.</p>	<p>Front panel doesn't support handheld microphone, and need to use the fixed microphone. To make sure of the sound quality, the distance from user to microphone should be no less than 1 meter.</p>
<p>When the touch screen connects CEC facilities and powers down, it will be powered off after restarting. CEC facilities can't recall the touch screen.</p>	<p>Please use the remote control to start and close the touch screen, then can use the CEC facilities to recall it.</p>

8 Specifications

Model	TWB-8619A	TWB-7519A	TWB-6519A
Display			
Backlight	LED		
Display Area	1898mm x 1069mm	1651mm x 929mm	1432mm x 807mm
Active Screen Size	86 inch	75 inch	65 inch
Display Ratio	16:9		
Resolution	3840 x 2160 Pixels		
Display Colors	10 bit, 1.07 billion colors	10 bit, 1.07 billion colors / 8 bit, 16.7 billion colors	8 bit, 1.07 billion colors
Brightness	≥ 350 cd/m ²		
Contrast	1200:1/4000:1 (varied by cell source)		4000:1
Viewing Angle	178°		
Life Time	30000 h (Min.)		
Speaker.			
Speaker Position	Forward		
Max. Power Output	2 x 15 W		
Electricity			
Power Consumption	Maximum ≤ 450 W Standby Mode ≤ 0.5 W	Maximum ≤ 400 W Standby Mode ≤ 0.5 W	Maximum ≤ 250 W Standby Mode ≤ 0.5 W
Power in Power Saving Mode	≤ 225 W	≤ 152 W	≤ 110 W
Working Voltage	AC 100 V – 240 V, 50 Hz/60 Hz		
Touch			
Touch Surface	Anti-glare tempered glass + Anti-finger print		
Transparency	88%		
Surface Hardness	7H		
HID Support	HID		
Touch Points	10 touch points for Android, 20 touch points for Windows		
Writing Tools	Eraser, Stylus or Finger		
Scan Speed	100Hz	120Hz	130Hz

Model	TWB-8619A	TWB-7519A	TWB-6519A
Touch sensor touch down latency	20ms	17ms	13ms
Transportation/Storage			
Storage Temperature/ Humidity	-20 °C – 60 °C/0% – 90% (no condensation)		
Working Temperature/ Humidity	0 °C – 40 °C/20% – 80% (no condensation)		
Mounting (Optional)	Wall-mounted/Floor Stand		
Outline Dimension	2019 mm x 1212 mm x 109 mm	1770 mm x 1071 mm x 109 mm	1546 mm x 944 mm x 96 mm
Packing Dimension	2170 mm x 1345 mm x 275 mm	1894 x 1193mm x 247m	1670 mm x 1056 mm x 221 mm
Net Weight	73±2 kg	57±2 kg	44±2 kg
Gross Weight	92±2 kg	73±2 kg	58±2 kg
Ports			
Front Interface Inputs	HDMI In x 1, USB (Touch) x 1, USB (2.0) x 2, Microphone In x 1		
Rear Interface Inputs	HDMI In x 2, DP x 1, VGA x 1, USB (Touch) x 4, HDMI Out x 1, Line Out x 1, SPDIF out x 1, USB 2.0 (Public) x 1, USB 2.0 (Embedded) x 1, RS-232 x 1, RJ45 x 2, USB 3.0 (Public) x 1, Audio In x 1, OPS Slots (4K@60Hz)		
Other Functions			
Intelligent Thermos Protector	Yes		
Build-in WI-FI	2.4G/5G (Optional)		
Smart System			
Chips	MSD848		
RAM	3GBytes (1G build in DDR3+2G on board DDR4)		
Flash	16GB build in		
Multimedia File Formats	Supports all major types of multi-media files		