



Meaco DD8L desiccant dehumidifier Instruction Manual



Meaco DD8L Desiccant Dehumidifier
November 2019 edition

Please read this instruction manual before using the dehumidifier and keep safe for future reference.

Thank you for choosing Meaco, we really do appreciate it.

PRODUCT DESCRIPTION

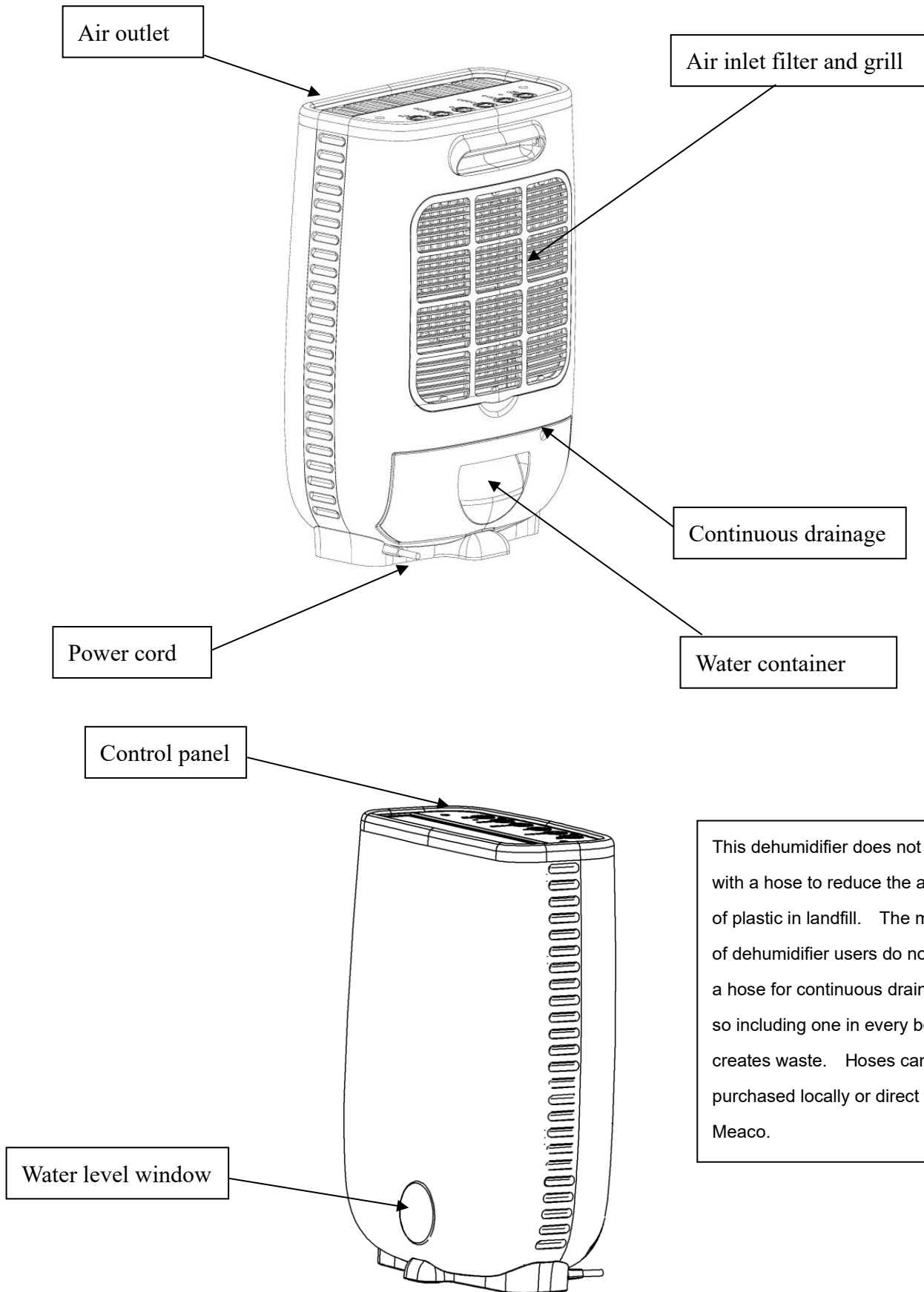

SAFETY INSTRUCTIONS

PLEASE READ ALL INSTRUCTIONS CAREFULLY BEFORE OPERATING.

In case of a failure whilst under warranty we will collect the dehumidifier from you for repair/replacement, therefore please save the packaging and keep it safe away from children. When you do dispose of the packaging please recycle.

WARNING - This appliance is intended for use in a domestic environment only. Any other use is not recommended by the manufacturer and may cause fire, electrical shocks or other injury to person or property. When using electrical appliances, basic safety precautions should always be followed:

1. Do not operate the unit with a damaged cord or plug, after it malfunctions or has been dropped or damaged in any way. Return to an authorized service facility for examination and repair.
2. This unit should always be kept in an upright position to avoid any damage. Locate the unit on a flat stable surface.
3. Check the household voltage to ensure it matches the units rated specification before operating.
4. Operate this unit in an ambient temperature between 1°C and 37°C.
5. Ensure that the air inlets and outlets are not blocked or covered.
6. Do not place the unit too close to curtains or other objects - min 30cm.
7. When using the "Laundry  " to speed up the drying of wet clothes in the room, keep the clothing at a safe distance from the unit to prevent water from dropping onto the unit.
8. Never place anything on top of the unit and do not cover with any kind of material while in use.
9. This product is intended for domestic and light office use ONLY and not for commercial, industrial or outdoor use.
10. To protect against electrical shocks, do not immerse unit, plug or cord in water, or spray with liquids.
11. Never unplug the power cord without press the "Power" key to off first, as this could damage the unit. Never unplug the dehumidifier before the fan has stopped blowing.
12. Always unplug the unit when not in use or moving location. To disconnect from the power supply, grip the plug and pull from the power socket. Never pull by the cord.
13. Always empty the water tank before storing the unit away.
14. This appliance can be used by children aged from 8 years and above and persons with reduced physical, sensory or mental capabilities or lack of experience and knowledge if they have been given supervision or instruction concerning use of the appliance in a safe way and understand the hazards involved
15. Do not run power cord under carpeting, or cover with rugs or runners. Arrange the cord away from areas where it may be tripped over.
16. Never operate or store the unit in direct sunlight.
17. To repair the unit, take it to a qualified service engineer. Repairs carried out by unqualified people

may cause damage to the unit or injury to persons or property and void the warranty.

18. Where possible, avoid the use of an extension cable as they may overheat and cause a risk of fire. Only use an extension cord after ensuring it is in perfect condition. Extension leads can also cause voltage drop which will affect the dehumidifier. This is more likely when being used in garages and out buildings.

19. Do not use the unit without the air filter as this will allow dirt to gather inside the dehumidifier and could invalidate the warranty.

20. Check the filter regularly in order to keep it clean as per page 13. A dirty filter will restrict the air flow into the machine which will increase the resistance on the fan and could result in damage and might invalidate the warranty.

21. If the dehumidifier is knocked over then a safety tilt switch will turn it off.

BS PLUG WIRING

Wiring Instructions: Should it be necessary to change the plug please note the wires in the mains lead are coloured in accordance with the following code :

BLUE - NEUTRAL

BROWN - LIVE

GREEN AND YELLOW – EARTH

As the colours of the wires in the mains lead of this appliance may not correspond with the coloured markings identifying the terminals in your plug, proceed as follows:

1. The **BLUE** wire is the **NEUTRAL** and must be connected to the terminal which is marked with the letter **N** or coloured **BLACK**.
2. The **BROWN** wire is the **LIVE** and must be connected to the terminal which is marked with the letter **L** or coloured **RED**.
3. The **GREEN/YELLOW** is the **EARTH** and must be connected to the terminal which is marked with the letter **E** or or coloured **GREEN OR GREEN/YELLOW**.
4. Always ensure that the cord grip is positioned and fastened correctly.

If a 13A (BS 1362) fused plug is used it must be fitted with a 13A fuse. If in doubt consult a qualified electrician.

Wiring for a 13Amp Plug (BS1362)

Please note. The Earth Terminal is marked with the letter **E** or Earth Symbol.

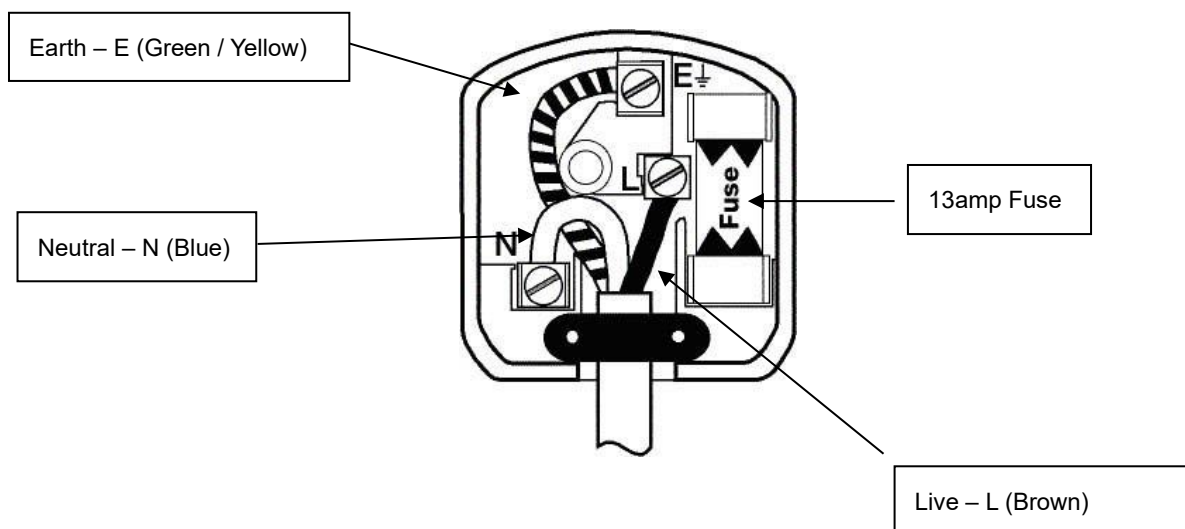

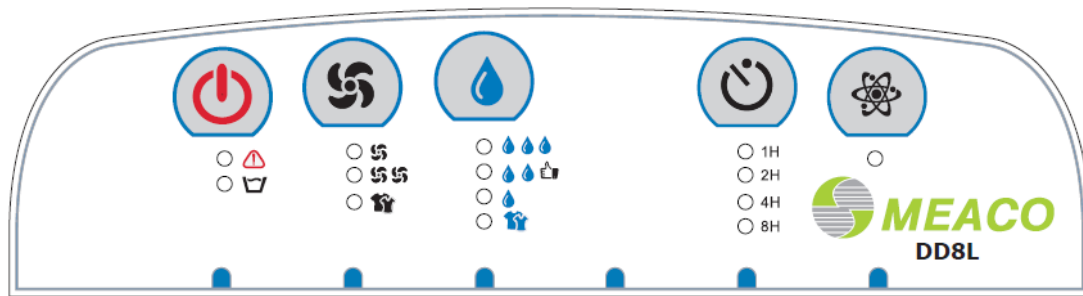

THE CONTROL PANEL





Power  - Press this button to turn the dehumidifier on, the unit beeps three times when it is turned on.

Tank Full  - Lights up when the internal tank is full of water and needs to be emptied or when the tank is incorrectly fitted.

Fault  - Lights up when a fault is detected. Most common would be the air inlet being blocked leading to the dehumidifier over heating internally. Clean the filter; make sure that the dehumidifier is not next to a heat source (i.e. a radiator) and restart the dehumidifier after ten minutes. See the trouble shooting section at the end of the manual.

Fan  - Press the Fan button to toggle between the three fan speeds, low, medium and high. In High fan speed the machine defaults to a Continuous running mode. Water extraction will increase in medium and high fan speeds because the regeneration heater will switch to maximum power (this increases the running wattage of the dehumidifier as well and the amount of heat delivered to the room).

Maximum * -Runs the dehumidifier until a relative humidity of 40%rh has been reached the dehumidifier then it goes into the 30 minute cycle as detailed in bold below.

Normal * -Aims to achieve a relative humidity of 50%rh which will be fine for most household applications. To prevent condensation on single glazed windows or when the outside temperature drops below about 5°C you should use Maximum instead of Normal. Once 50% has been reached the dehumidifier then goes into the 30 minute cycle as detailed in bold below.

Minimum * - Controls the relative humidity to 60%rh which will prevent mould from growing in the immediate vicinity of the dehumidifier but not throughout a whole house. Once 60%rh has been reached the dehumidifier then goes into the 30 minute cycle as detailed in bold below.

Laundry * - Use this mode when you want to dry washing. For optimum performance place the dehumidifier in as small a room as possible with the door and windows closed. The dehumidifier will dry continuously to try to achieve a relative humidity of about 35%rh which will help to dry the washing efficiently. In Laundry Mode the dehumidifier will turn off after 6 hours to save energy.

Take care to ensure that the dehumidifier does not become covered by the washing and that no water drips onto the dehumidifier.

Timer  - Using this button turns the machine off after either 1, 2, 4 or 8 hours of use. This setting is useful for drying washing in a set time.

Ion  - Turns the ioniser function on or off. An ioniser delivers negative ions into the air, these will attach themselves to positive ions (dust for example). This action makes the new particle heavier and the particle will fall to ground and will either be captured by the filter or will settle on the floor ready to be vacuumed up. The advantage of this is that you are less likely to inhale the particle which is good news if you are allergic to certain pollutants and the air will be cleaner.

***In the three modes that are controlled by the relative humidity stat (Minimum/Normal and Maximum) when the target relative humidity has been reached the dehumidifier will stop drying the air but the fan will continue to run for 10 more minutes. When this happens no more water will be collected, this is perfectly normal. The fan then goes to sleep for 30 minutes after which it will wake up and sample the air so that the dehumidifier knows when to start collecting water again, but if the relative humidity remains below the target then the fan will go to sleep again for another 30 minutes and so on. When the relative humidity rises again the dehumidifier will automatically start to collect water again. Although the Laundry mode aims for a lower relative humidity it will reach a point after which there will be no more water to collect because it will not over dry the air below a point at which the air will become uncomfortable (around 35%rh).**





If one of the following events happens then the control panel will lock up and the fan light will flash.

- Temperature below 10°C
- Temperature above 40°C
- Relative humidity below 40%rh
- Machine has been working hard and needs to cool down internally

If you find that this happens and none of the buttons on the control respond, **then do not worry, this is normal** and the dehumidifier is still drying the air as per the setting you left it in. The control panel will start to work again when the conditions allow.

Occasionally you might notice the temperature of the air coming out of the dehumidifier will feel cooler. This is perfectly normal and part of the overall dehumidification process whereby the heater is rested during the regeneration process for the desiccant wheel.

DEHUMIDIFIER SETUP AND USE

- Place the dehumidifier in an upright position on a stable, flat surface.
- Please ensure the unit is a safe distance away from a wall or furniture.
- Please keep clothes at a safe distance of 30cm away from the air inlet or outlet to prevent water from dripping into the unit.
- Ensure the tank is correctly fitted, if the tank is full or is not in place, the “Empty Tank”  light comes on, an alarm will sound and the dehumidifier will turn off.
- Press the Power button , you should hear some bleeps.
- Select the Mode that you want to use the dehumidifier in, for most applications this will be the “Normal”  mode.
- To turn off press the Power button  again.

Where to position the dehumidifier

- For best results position the dehumidifier somewhere central like a landing or a hallway. As long as the internal doors are open the moisture will migrate naturally towards the dehumidifier to be processed.
- To dry washing it is best to put the dehumidifier into a small room with some heating on. Close the door and windows and use the dehumidifier in “Laundry”  mode. Hang the clothes so that they are not touching each other and so that air can circulate between the clothes. Ensure that water does not drip onto the dehumidifier.

Smell coming from the dehumidifier

When you first use the dehumidifier and periodically afterwards you might notice a smell coming from the dehumidifier. This is caused by the Zeolite desiccant material and is not a sign that the dehumidifier is faulty, nor is it harmful to humans or pets. The smell occurs because the Zeolite absorbs odours from items like cigarettes, cosmetics, hair sprays, building materials and new furniture and then when the desiccant is heated the smell is discharged into the room. This smell has been described as being like a burning smell or a sour smell. It is normal, will not last long and is not a sign of a fault. You can clear it by running the dehumidifier in a separate space like a garage or if it is dry – outside.

Amount of water collected

- When you first use your dehumidifier it will work harder to reduce the room humidity down to 50%rh (in “Normal” mode). This is the time when it will produce the most water and need emptying most frequently. As the room becomes dryer the dehumidifier collects less water and takes longer to fill the tank, this is perfectly normal. When the target relative humidity has been reached the dehumidifier will stop collecting water, again this is normal.
- If you find that you still have condensation on your windows or you need to dry the air further then use the “Maximum” mode. This might well be necessary if you have single glazed windows or if the outside air temperature drops towards freezing.

- In the three modes that are controlled by the relative humidity stat (Maximum/Normal/Minimum) when the target relative humidity has been reached the dehumidifier will stop drying the air and will then run the fan for 10 minutes to make sure that the relative humidity is stable. When this happens no more water will be collected, this is perfectly normal. The fan then goes to sleep for 30 minutes after which it will wake up and sample the air so that the dehumidifier knows when to start collecting water again, but if the relative humidity remains below the target then the fan will go to sleep again for another 30 minutes. When the relative humidity rises again the dehumidifier will automatically start to collect water again.
- Although the Laundry mode  aims for a lower relative humidity it will reach a point after which there will be no more water to collect because it will not over dry the air below a point at which the air will become uncomfortable.

Turning off

When you press the Power button to turn your dehumidifier off the fan will run for another ten minutes before it shuts down. This is normal and part of an essential process to cool the inside of the dehumidifier down. Please do not try to interrupt the cooling down process by unplugging the dehumidifier from the wall socket, the machine will turn off once the ten minutes as past.

To operate safely

- Do not insert small objects into the unit or this will damage it and cause a hazard.
- Do not remove the tank when the dehumidifier is running or water may leak.
- Minimum operating condition 1°C at 40%rh relative humidity.



ATTENTION !

- Never use the device with a damaged power cord, plug, cabinet or control panel. Never trap the power cord or allow it to come into contact with sharp edges.
- Failing to follow the instructions may lead to the guarantee becoming void.

EMPTYING THE WATER

Continuous Drainage

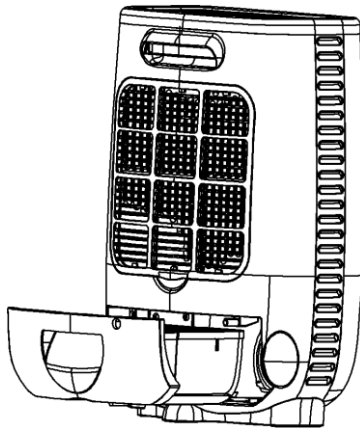

When the water container is full:

The DD8L will stop dehumidifying and the fan will stop after a cool down period.

The DD8L will then bleep and the Empty Tank LED will flash 

Empty the water container and replace it in the correct position.

The dehumidifier will start to work again.

If the “Empty tank” light stays on and the unit does not start up then the tank is not correctly fitted.

Continuous Drainage

It is possible to connect the drainage hose (**NOT** included in the box, please use a hose with 8mm internal diameter) to the dehumidifier for permanent water drainage. Simply connect the hose to the drain spout and ensure that the end of the hose is lower than the drain opening, otherwise the water will not drain and flooding may occur.

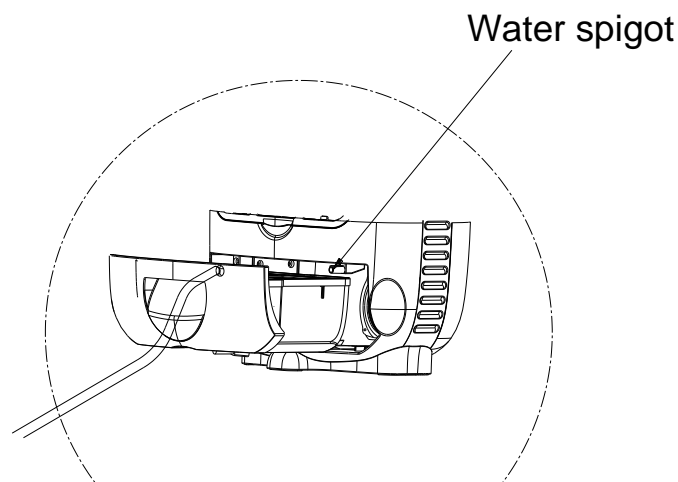

If you find that the water does not flow down the hose then check that it is running downhill, is not kinked, all excess tube has been cut off and is not blocked. If the water still does not flow then make a 4mm hole, 30mm from the spout in the top of the hose. This will balance out the air pressure and allow the water to flow.

When you no longer wish to use the permanent water drainage, disconnect the drainage tube from the device. Ensure that the water container is positioned correctly.

CLEANING

Switch the dehumidifier off and remove the plug from the socket before cleaning.

The exterior

Clean the exterior with a soft, dry cloth. If the device is extremely dirty, use a mild cleaning agent.

Wipe the dehumidifier with a slightly damp cloth. Never spray the device with water.

The air filter

When used regularly, the filter may become clogged with dust and particles. Therefore the filter should be cleaned at least every two weeks. Follow these steps:

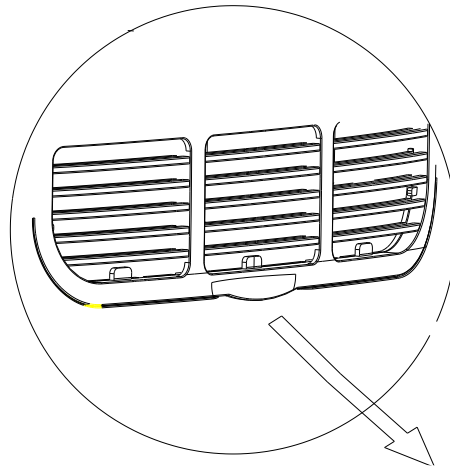

1. Remove the filter.
2. Clean the filter with a vacuum cleaner and not with water as this will damage the anti-bacterial properties of the filter.



Never use the device without the air filter.

STORAGE

Storage

If the machine will not be used for a long period of time, take the following steps:

1. Remove the plug from the socket and empty the container. Allow the container and the dehumidifier to dry completely.
2. Clean the air filter.
3. Store the device in a dust-free location away from direct sunlight, preferably covered with a sheet of plastic.

TROUBLESHOOTING

Check the following before contacting technical support:

Problem	Cause	Solution
The unit does not work.	The power is not connected.	Insert the plug into the wall outlet.
The device does not dehumidify.	The water container is full.	Remove the water from the container.
	The water container has not been replaced correctly.	Place the water container in the correct position.
	The air filter is clogged.	Clean the air filter.
	The temperature in the room where the dehumidifier is operating is too low.	The machine does not dehumidify below 1°C, it is highly unlikely at that temperature that there is any moisture to remove anyway.
	The relative humidity in the room where the dehumidifier is operating is too low.	The dehumidifier dries down to the target relative humidity set and then goes into fan only mode until the relative humidity goes above the set point again.
The dehumidifier works, but reduces the relative humidity insufficiently/there is little water in the water tank.	The house is too large. This dehumidifier can dry up to about a small five bedroom house.	We recommend using a dehumidifier with a greater capacity.
	There are too many sources of moisture. Bathing, washing, drying clothes and cooking all puts moisture into the air. Portable gas heating can add too much moisture into the air for a dehumidifier.	We recommend using a dehumidifier with a greater capacity. Consider using a different heat source to a portable gas heater.
	There is too much ventilation.	Reduce ventilation (e.g. close windows and shut doors.)
	The air filter is blocked and the reduce air flow is effecting performance.	Clean the air filter.
The windows were clear and now condensation has returned.	The outside air temperature has dropped and the windows are colder.	Use the dehumidifier on Maximum and run it 24 hours a day.
I cannot remove the condensation from my windows, even in Maximum mode.	The surface temperature of the windows is too low for a dehumidifier to prevent condensation. Common with single glazed windows and when the outside air temperature drops below freezing.	Keep running the dehumidifier on Maximum 24 hours a day and when the air temperature outside increases the windows should clear of condensation.
Dehumidifier is blowing out warm air.	The dried air is passed over a heating element before it is blown into the room as part of the dehumidification process.	This is normal, a dehumidifier is not an air cooler.

Problem	Cause	Solution
Knocking noise coming from the dehumidifier	Motor that rotates the desiccant wheel is low on lubrication.	Run the dehumidifier in Laundry mode for two days to increase the lubrication, if fault persists then call Meaco.
Alarm light on continuously	Restricted airflow to the dehumidifier or temperature below freezing.	Clean the filter and make sure that the unit is more than 30cm from a wall. If the temperature is below freezing then use the dehumidifier when the space warms up again.
Alarm light flashing	Restricted airflow to the dehumidifier.	Clean the filter and make sure that the unit is more than 30cm from a wall.
Water not draining down the hose	Hose is fitted for continuous drainage but the water still goes into the tank.	Negative air pressure in the room is pulling the water back into the dehumidifier overflow. Insert a 4mm hole into the top of the tube 30mm down from the spout. This will introduce air into the tube and balance out the air pressure.
Dehumidifier leaks water onto the floor	Usually means that the dehumidifier is not on a level surface or that the filter has not been cleaned often enough and dirt has fallen into the dehumidifier.	You can also check that the water bucket is not cracked by filling it with water and placing it on kitchen paper on the kitchen side.
Machine not switching off and on in the usual 30 minute pattern	Temperature and relative humidity sensor that reads the room reading is unable to read the correct readings.	Clean the filter and blow the air sensor with a hair dryer on fast setting to clear the sensor of dirt. Unplug the dehumidifier for 10 minutes to reset it's circuits and then turn back on.
Unit only works in Laundry mode and Laundry light stays on or flashes.	If the humidity sensor is faulty then the dehumidifier will only run in Laundry mode.	Try clearing the sensor as per above line, if that fails then call Meaco for a repair.
Medium fan speed light flashes	None of the buttons work.	This is normal and the unit is functioning ok. The unit will return to normal operation when conditions allow. More details below.

If one of the following events happens then the control panel will lock up and the fan light will flash.

- Temperature below 10°C
- Temperature above 40°C
- Relative humidity below 40%rh
- Machine has been working hard and needs to cool down internally.

If you find that this happens and none of the buttons on the control respond, then do not worry, this is normal and the dehumidifier is still drying the air as per the setting you left it in. The control panel will start to work again when the conditions allow.

CONDITIONS OF WARRANTY

There is a two year warranty on your dehumidifier from the date of purchase. Please register your purchase at <https://meaco.com/warranty-register>, as a thank you will be entered into a free prize draw. Registering also allows us to keep you update with any important developments concerning your product.

All material or manufacturing defects will be repaired free of charge.

The following applies:

- Any repairs or replacement of components during the warranty period will not result in an extension of the warranty period.
- The warranty will expire if any alterations have been made to the dehumidifier, if third party components have been fitted or if the dehumidifier has been repaired by a third party.
- Components subject to normal wear and tear, such as the air filter, are not covered by the warranty.
- The warranty is only valid on presentation of the original, unaltered, and date-stamped purchase receipt.
- The warranty does not cover damage caused by actions that deviate from those as described in the user's manual or by neglect.
- All claims for compensation, including consequential damage, will not be entertained.
- The warranty can be invalidated if the dehumidifier is found to be dirty or if components inside are clogged with dirt.

To prevent unnecessary expenses, we recommend that you always carefully read the user's manual first. If this does not provide a solution, then call Meaco (U.K.) Limited on 01483 234900 between Monday to Friday 9am to 5pm.

This appliance can be used by children aged from 8 years and above and persons with reduced physical, sensory or mental capabilities or lack of experience and knowledge if they have been given supervision or instruction concerning use of the appliance in a safe way and understand the hazards involved.

Children should be supervised to ensure that they do not play with the appliance.

TECHNICAL SPECIFICATIONS

Model	Meaco DD8L desiccant dehumidifier
Power consumption	30/330/650 watts
Power supply	220-240V / 50Hz
Dehumidifying capacity	8 litres / day
Capacity water container	2 litres
Air flow	80/100/115m ³ /h
For homes up to	Small 5 bedroom house
Operating range	1 – 37°C
Dimensions (w x d x h)	351 x 188 x 500mm
Net weight	6.4Kgs
Gross weight	7.4Kgs
Sound pressure level	39/43/48dB
Fuse rating	250V. F1.6A
Tilt switch	Electronic tilt switch to turn the unit off if it is knocked over



This marking indicates that this product should not be disposed with other household wastes throughout the EU. To prevent possible harm to the environment or human health from uncontrolled waste disposal, recycle it responsibly to promote the sustainable reuse of material resources. To return your used device, please use the return and collection systems or contact the retailer where the product was purchased. They can take this product for environmental safe recycling.



CUSTOMER SERVICE

This dehumidifier has been imported into the U.K. by;

Meaco (U.K.) Limited
Meaco House
Parklands
Railton Road
Guildford
GU2 9JX

Telephone: 01483 234900
Email: customerservice@meaco.com
Website: www.meaco.com
Fax: 01483 232700

Please record, for future reference, your date of purchase and where you bought the dehumidifier from here.

Date of purchase.....

Purchased from www.meaco.com (if not then please record the supplier's name below).

.....

Meaco are specialists in dehumidifiers and would welcome your comments and questions on this dehumidifier. If you do develop a fault within the first year then please do call us and if we cannot fix the problem over the phone we will be happy to collect the dehumidifier from you at our expense and repair or replace as appropriate.

Please save the box just in case this happens.