

Goldair™



Operating Instructions

Goldair Straight Round Towel Warmer



Models: GTR5B, GTR7B

General Care and Safety Guide

Thank you for choosing a Goldair Towel Rail. This Goldair Towel Rail has been designed and manufactured to high standards of engineering and with proper use and care, as described in this leaflet, will give you years of useful service. Please read these instructions carefully.

1. This Towel Rail is not intended for use by persons (including children) with reduced physical, sensory or mental capabilities, or lack of experience and knowledge, unless they have been given supervision or instruction concerning use of the Towel Rail by a person responsible for their safety.
2. Children should be supervised to ensure that they do not play with the Towel Rail.
3. In order to avoid a hazard, this Towel Rail must be installed so that the bottom rail is at least 600mm above the floor.
4. These towel rails must be located and installed in accordance with the AS/NZS 3000:2007 and any local regulation information for mounting in damp areas.
5. This Towel Rail is intended to warm and dry towels and therefore is hot to the touch.
6. Any rise in ambient temperature is directly reflected in the Towel Rail, and as a result of this, the Towel Rail will feel hotter to the touch during warmer periods. Also the insulation effect of towels will cause the operating temperature to increase slightly.
7. Means of disconnection must be incorporated in the fixed wiring in accordance with wiring guidelines AS/NZS 3000:2007.
8. The towel rail is to be installed so that switches and other controls cannot be touched by a person in the bath or shower.
9. Do not use this towel rail for any purpose other than its intended use.
10. To avoid a hazard this towel rail must not be used to hold towels or any other articles that have been in contact with oil, petroleum based products or dry cleaning fluids.
11. Use this Towel Rail only with the voltage specified on the rating label.
12. Do not immerse in liquid or allow liquid to run into the interior of the Towel Rail.
13. Indoor use only.
14. Do not operate this towel rail if damaged or after the Towel Rail malfunctions or has been dropped or damaged in any manner. Return to a qualified electrical person for examination, electrical service or repair.
15. This Towel Rail is intended for household use only and not for commercial or industrial use.
16. Use this Towel Rail only as described in this manual. Any other use is not recommended by the manufacturer and may cause fire, electrical shock or injury

General Care and Safety Guide (continued)

17. Do not use abrasive cleaning products on this Towel Rail. Clean with a damp cloth (not wet) rinsed in hot soapy water only. Always switch off at the mains supply before cleaning.
18. Do not connect the Towel Rail to mains supply until completely assembled and adjusted.
19. Do not use this Towel Rail in a window as rain may cause electric shock.
20. Do not mount Towel Rail close to any other heat source.
21. Do not operate in areas where petrol, paint or other flammable liquids are used or stored.
22. Do not locate the Towel Rail directly below any power socket.
23. When the Towel Rail has been unpacked, check it for transport damage and ensure all parts have been delivered. If parts are missing or the Towel Rail has been damaged, contact the Goldair Customer Services Team.
24. If your Towel Rail does not work, or is not working properly, contact the place of purchase or the Goldair Customer Services Team. Repair work on the Towel Rail by unqualified persons can cause serious risk to the user.
25. There are no user serviceable parts installed in the unit.
26. Do not place the unit in wardrobes or other enclosed spaces as this may cause fire hazards.
27. This unit is not supposed to be used in or around locations where foodstuffs, works of art or delicate articles of science, etc are stored.

Specifications

DIMENSIONS		
Model:	GTR5B	GTR7B
Height:	570mm	800mm
Width:	630mm	630mm
Depth:	107mm	107mm
ELECTRICAL		
Wattage:	60W	85W
Colour:	Black	Black
Power supply:	220-240 VAC 50Hz	230-240 VAC 50Hz
International Protection Rating: IP55		

Dimensions

GTR5B

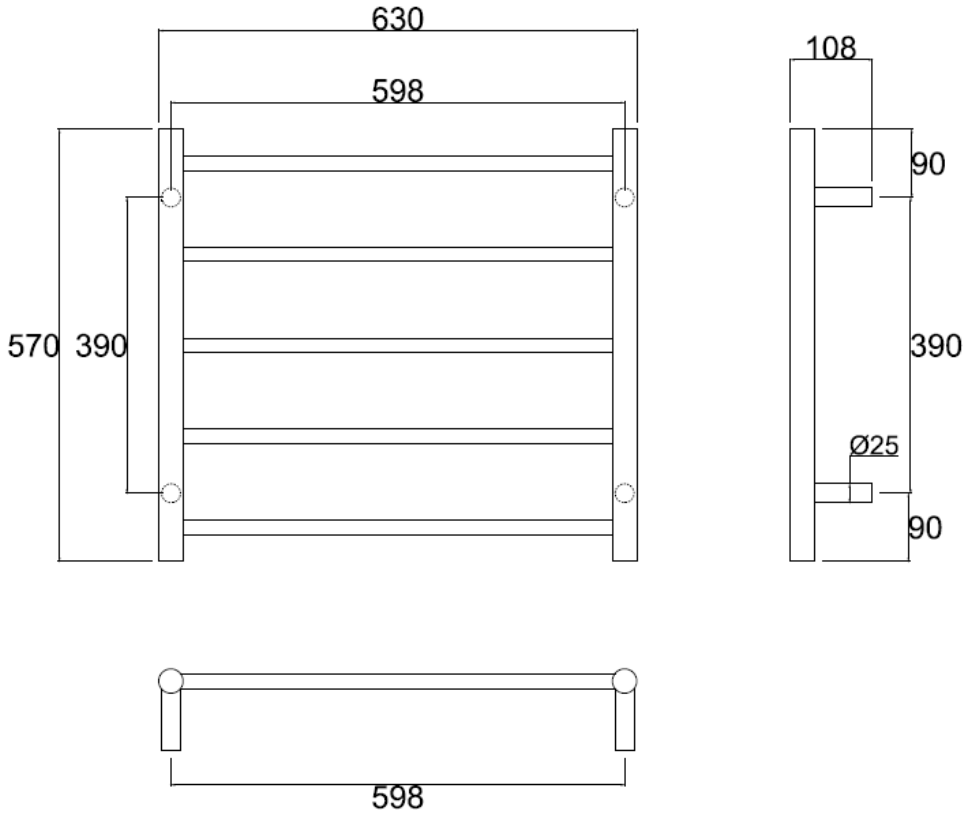

GTR7B

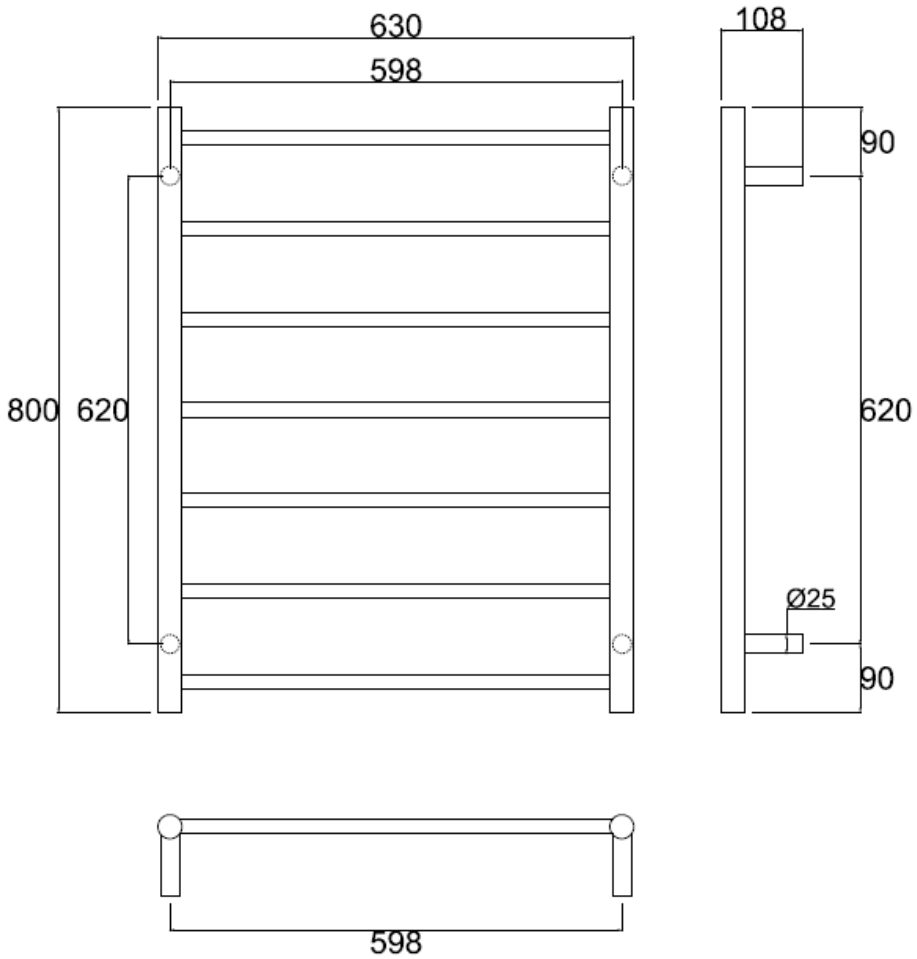

Components



2 x Upper Legs



4 x Grub Screws



2 x Lower Legs
1 leg has a cut out for
exposed wire install

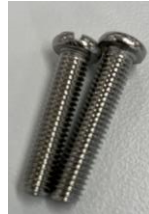

2 x Screws
for Securing Upper Legs



3 x Mounting Bush



2 x Screws for Securing
Lower Legs



1 x Through Wall Bush
For Concealed Cable



4 x Long Screws
For mounting to wall



1 x Allen Key



4 x Wall Plugs

Installing your Towel Rail

WARNING: Installation must be completed by a registered electrician.

Always choose a safe location for the Towel Rail, keeping in mind the safety precautions outlined. Ensure all packaging has been removed from the unit before use.

WALL MOUNTED TOWEL RAILS ARE ONLY TO BE MOUNTED ON HEAT RESISTANT WALLS THAT COMPLY WITH CURRENT AS/NZS SPECIFICATIONS & BUILDING REGULATIONS

WALL PREPARATION

Goldair Heated Towel Rails may be fixed to any type of timber stud, steel stud or masonry (solid or cavity) wall.

Walls made from timber or steel require studs at the correct position for all rails. If the precise position can't be determined early in the job, consider sheets of 18mm construction ply, covering a larger area.

This rail has a small footprint against the wall. The wire holes and mounting holes must be drilled neatly and accurately.

For drilling through hard materials such as porcelain tiles, marble, granite etc. an appropriate drill bit must be used.

No responsibility will be taken by Goldair for instances where installers drill incorrectly.

NOTE: Attempting to fix into plasterboard or cement sheeting alone is not recommended. Plasterboard in particular will not hold long term.

PRE WIRING

NOTE: Only drill holes when you are 100% sure of your measurements.

A means for disconnection must be incorporated in the fixed wiring in accordance with the wiring guidelines AS/NZS 3000:2007.

Provision should be made for a Timer to control the mains supply. It is recommended that a Timer is used for energy saving purposes. Goldair recommend a Goldair Heated Towel Rail Timer (GBT100 – not supplied).

Installing your Towel Rail

MOUNTING INSTRUCTIONS

You must next select which side of the towel rail is needed to be wired in. The heated towel rail within this box has two wiring options (left or right hand). The location of existing wiring through or on the wall will dictate which side you will use.

For Left hand wiring, connect the power cable from Point A.

For Right hand wiring, connect the power cable from Point B.

For the side that you do not use, insert the termination plug into the power cable and secure with the cap screw fitting.



Select desired position to mount towel rail with at least 300mm clearance from all permanent objects in surrounding area and the bottom rung must be 600mm above the floor. The Ladder Towel Rail should be installed in accordance to local governing AS/NZS regulations. The Goldair Heated Towel Rail can only be mounted 1 way. Your towel rail is mounted by legs with a screw on each of the 4 legs as indicated in Fig1. below.

CONCEALED OR EXPOSED WIRING

First, select which method of cord entry your installation situation requires – exposed or concealed. (please see images below as an indication to the differences)

The accessory pack contains a set of 4 legs for your heated towel rail – one of which is a universal leg (used for both concealed and exposed installations)

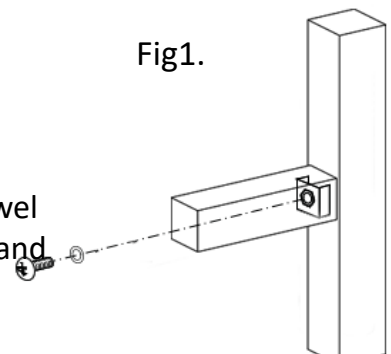

Installing your Towel Rail



1. Feed a leg mounting screw through the middle of the upper leg (upper legs have a welded mounting point inside the leg). There is a locator hole at the base end which this screw should line up with and pass through.



2. Align the screw with the threaded hole of the upper leg positions on the towel rail, ensure grub screw is facing down. Tighten so that the legs are secured onto the upright tube. Do not overtighten, leave just enough give to allow the leg to rotate and align parallel with other legs.



3. Repeat steps 1 & 2 to attach the second upper leg
4. Using the short lower leg mounting screw, secure the non-wired side, lower leg by sliding the leg over the lower leg mount on the towel rail. Ensure the grub screw is facing down.

NOTE: Use the lower leg with the cutout for the side (either left or right) where the power cable is located.



5. The last lower leg should be installed either in a concealed or exposed manner, as per the previous page. For exposed wiring – ensure you use the included black cable guide to prevent damage to the power cable.

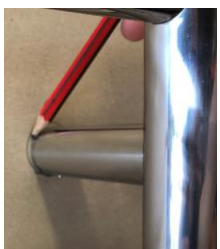

6. Hold the towel rail against the wall in the location where you want the towel rail mounted. Ensure it is located parallel using a spirit level. Using a pencil, mark the four legs position on the wall.

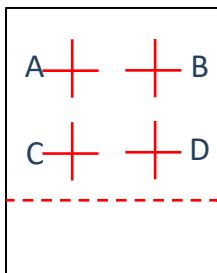

7. Mark the centers on the wall, note that the towel rail should be installed so that the bottom rail is at least 600mm above floor level.

Installing your Towel Rail

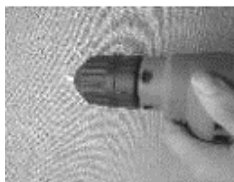

8. Drill holes in the marked location to suit the screws provided, If installing into Gib board, Concrete or Block, insert wall plugs into the wall.



9A. If using an exposed cable, insert a long screw through the mounting bush, then fix into wall ensuring the fit is secure – ideally you should screw into timber for sufficient strength. Do this for all 4 legs.



9B. If completing a concealed cable installation, you will need to use the Through Wall Bush for mounting the last leg. Ensure you pass the power cable through the lug before installing to the wall. Screw through the smaller hole – leaving the larger hole for the cable to exit. Ideally you should drill through a timber joist to give it strength.

10. ENSURE THE MAINS POWER IS OFF BEFORE ELECTRICAL CONNECTION - Remove the lower leg on the side you have selected for the power connection. Pass the power cable through the leg and connect it to the towel rail, screw the leg back onto the towel rail.

11. Align your towel rail over the top of the 4 mounting bushes, ensure all legs cover the mounting bushes. Make sure the towel rail fits correctly - do not force into place if the alignment is not correct.



12. Tighten the grub screws with the Allen key supplied, this will secure your towel rail to the wall. If using the Through Wall Bush you will need to replace the 'grub' screw in that leg for the Pointed grub screw supplied.

Operating your Towel Rail

ELECTRICIAN INFORMATION

A copy of this User Manual should be left with the consumer for future reference.

A means for disconnection must be incorporated in the fixed wiring in accordance with the wiring guidelines AS/NZS 3000:2007.

HEAT CONTROL

These towel rails run at a single temperature. Be aware they do get very hot to the touch.

CAUTION: The Towel Rail generates heat during use. Proper precautions must be taken to prevent the risk of burns, scalds, fires or other damage to persons

Do not attempt to dismantle the Towel Rail. There are no user serviceable parts. For service or repair, contact an authorised electrical service technician.

CARE AND CLEANING

The Towel Rail requires regular cleaning to ensure longevity of the product.

Turn off the isolating switch before cleaning. For additional protection, turn the mains supply off before cleaning.

Ensure that the towel rail has been allowed to cool down completely before cleaning.

Use a damp cloth (not wet) to wipe the exterior of the towel rail to remove dust and dirt.

Never use solutions such as benzene, thinners or polishing agents.

Never use abrasive materials like steel wool / scourers to scrub the towel rail.

Ensure the Towel Rail is dry before switching back on the mains supply and isolating switch.

RUST

Surface rust can occur on stainless steel over time. To avoid this the Heated Towel Rail is best wiped down from time to time with a damp cloth and a stainless steel cleaner. Fine scratching can be removed using a metal polish such as 'Autosol' or 'Brasso' Paste which are available from most supermarkets and car care shops.

PROOF OF PURCHASE

To receive warranty, retain receipt as proof of purchase.

Goldair[™]

SUPPORT AND TECHNICAL ADVICE

Goldair – New Zealand

Monday – Friday 8am-5pm

Phone +64 (0)9 917 4000

Phone 0800 232 633

info@cdb.co.nz

Goldair – Australia

Monday – Friday 8am-5pm

Phone +61 (0)3 9336 4423

Phone 1300 465 324

info@cdbgoldair.com.au



Two Year Warranty

Thank you for purchasing this Goldair product. Your product is warranted against faults and manufacture when used in normal domestic use for a period of **two years**. In non-domestic use Goldair limits the voluntary warranty to **three months**.

Goldair undertake to repair or replace this product at no charge if found to be defective due to a manufacturing fault during the warranty period.

This warranty excludes damage caused by misuse, neglect, shipping accident, incorrect installation, or work carried out by anyone other than a qualified electrical service technician.

PLEASE KEEP YOUR RECEIPT AS THIS WILL HELP VERIFY YOUR WARRANTY.

The benefits given to you by this warranty are in addition to other rights and remedies available to you under law in relation to the goods or services to which this warranty relates.

In Australia, our goods come with guarantees that cannot be excluded under the Australian Consumer Law. You are entitled to a replacement or refund for a major failure and compensation for any other reasonably foreseeable loss or damage. You are also entitled to have the goods repaired or replaced if the goods fail to be of acceptable quality and the failure does not amount to a major failure.

In New Zealand this warranty is additional to the conditions and guarantees of the Consumers Guarantee Act (1993).

Goldair – New Zealand

CDB Goldair
PO Box 100-707
N.S.M.C
Auckland

Phone +64 (0)9 917 4000
Phone 0800 232 633
www.goldair.co.nz

Goldair – Australia

CDB Goldair Australia Pty
PO Box 574
South Morang
Victoria, 3752

Phone +61 (0)3 9365 5100
Phone 1300 GOLDAIR (1300 465 324)
www.goldair.com.au

Goldair Two Year Warranty (IMPORTANT: Please complete and retain this warranty card)

Name _____

Address _____

Place Of Purchase _____ Date Of Purchase _____

Name Of Product _____ Model Number _____

Attach a copy of the purchase receipt to this warranty card

Goldair™



CDB  Goldair™

New Zealand
PO Box 100707,
North Shore Mail Centre,
Auckland, 0745
www.goldair.co.nz

Australia
PO Box 574,
South Morang,
Victoria, 3752
www.goldair.com.au