

Goldair™

PLATINUM



Operating Instructions

2400W Electronic Panel Heater with WiFi



Model: GPCV250

General Care and Safety Guide

YOUR SAFETY IS IMPORTANT TO US. PLEASE ENSURE YOU TAKE NOTE OF THE INSTRUCTIONS AND WARNINGS OUTLINED IN THIS MANUAL.

CAUTION: In order to avoid a hazard due to inadvertent resetting of the thermal cut-out, this appliance must not be supplied through an external switching device, such as a timer, or connected to a circuit that is regularly switched on and off by the utility.

- This appliance is not intended for use by persons (including children) with reduced physical, sensory or mental capabilities or lack of experience and knowledge, unless they are supervised or have been given instruction concerning the use of the appliance by a person responsible for their safety.
- Children should be supervised to ensure that they do not play with the appliance.
- If the supply cord is damaged, it must be replaced by the manufacturer, its service agent or similarly qualified persons in order to avoid a hazard.

WARNING: You must not cover this appliance. Covering this appliance presents fire risk and will activate the safety fuse; permanently disabling the unit.

WARNING: Do not use this appliance in small rooms when they are occupied by persons not capable of leaving the room on their own, unless constant supervision is provided.

WARNING: To reduce the risk of fire, keep textiles, curtains, or any flammable material a minimum distance of 1 metre from the air outlet.



- Use only the voltage specified on the rating label of the appliance.
- Keep all objects at least 1 metre from the front, sides and rear of the appliance.
- The heater must not be located immediately below a socket outlet.
- This appliance is intended for household use only and not for commercial or industrial use.
- Indoor use only.
- Use this appliance only as described in this manual. Any other use is not recommended by the manufacturer and may cause fire, electric shock or injury.
- Do not use the appliance if it has been dropped or damaged.
- The common cause of overheating is deposits of dust or fluff in the appliance. Ensure these deposits are removed regularly by unplugging the appliance and vacuum cleaning the air vents and grills.

General Care and Safety Guide

- Never use the appliance to dry clothes.
- Always unplug appliance when not in use.
- When the appliance has been unpacked, check it for transport damage and ensure all parts have been delivered. If parts are missing or the appliance has been damaged, contact the Customer Services Team.
- Do not use if there are visible signs of damage to the appliance.
- Do not connect the appliance to mains supply until completely assembled and adjusted.
- Ensure hands are dry before handling the plug or main unit.
- Ensure appliance is on a flat, stable, heat-resistant surface.
- Do not operate with cord set coiled up as a heat build up is likely, which could be sufficient to become a hazard.
- Carry out regular checks of the supply cord to ensure no damage is evident
- Do not operate this appliance with a damaged cord, plug or after the appliance malfunctions or has been dropped or damaged in any manner. Take to a qualified electrical person for examination, electrical service or repair.
- Do not twist, kink or wrap the cord around the appliance, as this may cause the insulation to weaken and split. Always ensure that all cord has been removed from any cord storage area and is unrolled before use.
- It is recommended that this appliance is plugged directly into the wall socket. Power boards are not rated to supply power to high wattage appliances.
- A correctly specified, undamaged extension cord may be used with this appliance provided it is used in a safe manner.
- Do not remove plug from power socket until the appliance has been switched off.
- Do not remove plug from power socket by pulling cord; always grip plug.
- Do not place cord under carpet or cover with rugs or furniture. Arrange the cord so it cannot be tripped over.
- Don't place appliance on bedding or on thick & long carpet where the openings may get blocked.
- Switch off and use handle provided when moving
- Do not place appliance close to radiant heat source.
- Do not insert or allow foreign objects to enter any ventilation or exhaust opening, as this may cause an electric shock, fire or damage to the appliance.
- Do not sit on the appliance.
- Do not use abrasive cleaning products on this appliance. Clean with a damp cloth (not wet) rinsed in hot soapy water only. Always remove plug from the mains supply before cleaning.
- Do not operate in areas where petrol, paint or other flammable liquids are used or stored.
- Do not use this appliance in the immediate surrounds of a bath, a shower, or a swimming pool or other liquids.

General Care and Safety Guide

- The appliance must not be immersed in any liquids.
- There are no user serviceable parts installed in the unit.
- Do not place the unit in wardrobes or other enclosed spaces as this may cause fire hazards.
- This unit is not supposed to be used in or around locations where foodstuffs, works of art or delicate articles of science, etc. are stored.
- If your appliance does not work, or is not working properly, contact the place of purchase or the Customer Services Team.

Goldair [™]	
Model No: GPCV250	
Supply: 230-240VAC 50Hz	Bluetooth
Wattage: 2200-2400W	
CLASS I	
Approval: TUV-027601-EA	
QC Passed: PO#-WWYY	
MADE IN CHINA	
CUSTOMER SUPPORT	
NEW ZEALAND PH: 0800 232 633	
AUSTRALIA PH: 1300 465 324	

Assembly

Before using this appliance, it must have the feet fitted. The screw pack to attach the feet to your appliance will be taped to one of the feet for your appliance or taped to the plug.

This appliance has been supplied with '1 way screws' for permanent installation of the feet. This is a safety requirement for the New Zealand and Australian market.

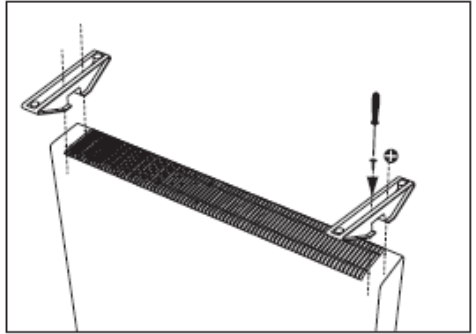
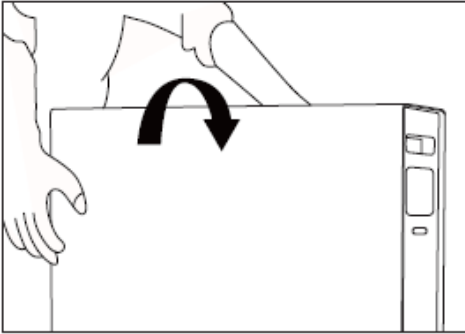

FREE STANDING

1. Ensure the appliance is unplugged and power switches are off.
2. Carefully turn the Main Body upside-down on a scratch-free and stable surface. Be careful to prevent damage to the cosmetic finish or your floor surfacing.
3. Align the screw hole on the Feet Bracket with the screw hole on the base of the appliance.
4. Attach feet with the screws provided and ensure the bracket sits firmly in place. Ensure the screws are tight and the feet are attached firmly.
5. Set appliance upright and plug into a standard 240 volt AC electrical outlet.

Operating Your Heater

Always choose a safe location for the heater, keeping in mind the safety precautions outlined. Ensure all packaging has been removed from the unit before use. Please follow the below instructions.

WARNING: In order to avoid overheating or fire, do not cover the heater.

WARNING: Keep all objects at least 1 metre from the front, sides and rear of the appliance.

WARNING: Do not use this heater with a programmer, separate timer, remote-control system or any other device that switches the heater on automatically, since a fire risk exists if the heater is covered or positioned incorrectly.

WARNING: Never leave this heater unattended when in use.

Ensure heater is on a flat, stable, heat-resistant surface.

Once the heater is in a safe operating position and all switches are in the off position, insert the power plug into the mains outlet and switch on.

CAUTION: Ensure the power cord is not tight because if pulled it may partially pull the plug from the socket. A partially inserted plug will overheat the plug and socket and could result in fire.

Note: When the appliance is turned on for the first time, it may release a slight odour or smoke. This odour or smoke is a normal occurrence caused by the initial heating of the internal heating elements and should not occur again.

Operating Your Heater

WARNING: Do not use this heater until it is fully assembled according to the instructions within this manual.

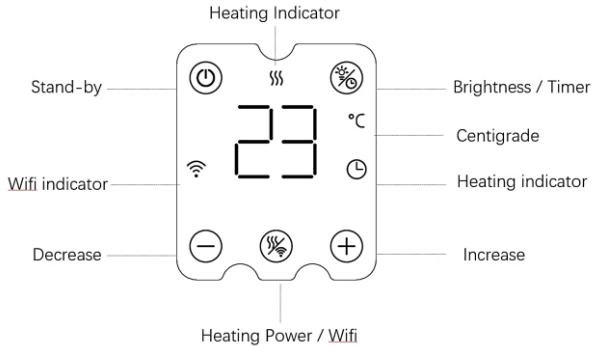

OPERATION

Plug in the unit and switch on the main power switch. The Stand-by power indicator will light up. Press the Power button (⏻) to turn the unit on. It will default to 19 °C.

HEAT SETTING

Press (+) or (−) to adjust to your ideal temperature between 5 – 35°C.

POWER SETTING

Press (🔥📶) to set power, the display will show:

- H1: 1500w
- H2: 2400w
- AF: Anti-frost mode (7 °C ± 3 °C (this cannot be changed))

WIFI CONNECTION

Hold down (🔥📶) for 3-5 seconds, the indicator (📶) will flash. You can now pair the device in the Goldair app. More instructions are on the following page.

TIMER

Hold down (🕒🔥) for 3-5 seconds and the display will show 0H. Press (+) or (−) to set the timer to turn the heater off between 1-24 hour. The display will tick down the remaining time until the heater will turn off.

SCREEN BRIGHTNESS

Press (🌞🔥) and the brightness will be reduced to 50%. Press again to cycle between 25%, 0% and back to 100%.

WiFi – Downloading and Setting up APP

This APP is supported only on 2.4GHz Wi-Fi channels. Please ensure your phone is 2.4GHz capable

**Note this device will only work within your home WIFI system.
This does not operate on 3G or 4G internet connections.
You will need a connection to your home Wi-Fi.**



Download Goldair mobile APP

- Open the APP Store or Google Play on your mobile phone.
- Open 'Search' and enter 'Goldair'
- Click 'GET' and begin to download and install.

Once downloaded to your phone open the APP

- Tap REGISTER near the bottom of the screen.
- Read and agree to the Privacy Policy.
- Add your email address.
- Tap 'Obtain verification code'

You will then receive an email with a verification code.

- Enter the verification code from your email.
- Create a password.
- Then tap confirm.

If you haven't received a verification code via email, tap the resend button and when the verification code is received follow above steps.

Your APP is now registered and ready for pairing to your device.

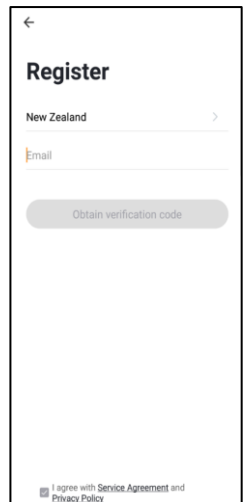
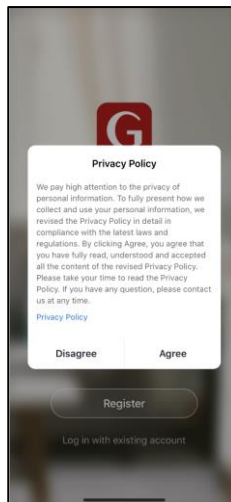

Pairing APP to Device

Details for pairing this heater to the Goldair App can be found at the below website link.

Either scan the QR code below or enter the website into your browser.

New Zealand Products



<https://www.goldair.co.nz/goldair-app>

Australia Products



<https://www.goldair.com.au/goldair-app>

Pairing Mode

To connect to the Goldair app you must ensure that your device is in pairing mode which is where the Wifi Icon is flashing.

- Put device on STAND-BY mode (ON at the wall but device is OFF)
- Hold down the **Wifi button**  for around 5 seconds or until the Wifi icon begins to flash.

Quick Connection

- Turn your phone's Bluetooth ON
- Ensure your device is in Pairing Mode (see instructions above)
- Tap the + on the top right corner to navigate to the main device screen. Tap 'Auto Scan' – your device will appear. Tap the device and follow the instructions.
- If Quick Connection does not work, follow the manual via the QR Code above

Operating Your Heater

SAFETY DEVICES

This appliance has three protection devices:

- Tilt Switch - this will automatically turn the appliance off if the appliance is not in the correct operating position.
- Resettable Thermal Link - this will automatically disconnect the power to the appliance at a pre-set overheat temperature. After cooling down it will reset and power on again. If this occurs, investigate what is causing the appliance to overheat.
- Thermal Fuse - this disconnects the appliance permanently in case of overheating. (It is non resettable).

CAUTION: The heater generates heat during use. Precautions must be taken to prevent the risk of burns, scalds, fires or other damage to persons.

CARE AND CLEANING

- The heater requires regular cleaning to ensure trouble free operation:
- Unplug the heater from the mains supply before cleaning.
- Ensure that the heater has been allowed to cool down completely before cleaning.
- The common cause of overheating is deposits of dust or fluff in the appliance. Ensure these deposits are removed regularly by unplugging the appliance and vacuum cleaning the air vents and grills.
- Use a damp cloth (not wet) to wipe the exterior of the heater to remove dust and dirt.
- Never use solutions such as petrol, thinners or polishing agents.
- Ensure the heater is dry before plugging back into the mains supply.
- Do not attempt to dismantle the appliance.
- There are no user serviceable parts. For service or repair, contact an authorised electrical service technician

PROOF OF PURCHASE

To receive warranty retain receipt as proof of purchase.

Goldair™

SUPPORT AND TECHNICAL ADVICE

Goldair – New Zealand
Monday – Friday 8am-5pm
Phone +64 (0)9 917 4000
Phone 0800 232 633
info@cdb.co.nz

Goldair – Australia
Monday – Friday 8am-5pm
Phone +61 (0)3 9365 5100
Phone 1300 465 324
info@cdbgoldair.com.au



Three Year Warranty

Thank you for purchasing this Goldair product. Your product is warranted against faults and manufacture when used in normal domestic use for a period of **three years**. In non-domestic use Goldair limits the voluntary warranty to **three months**.

Goldair undertake to repair or replace this product at no charge if found to be defective due to a manufacturing fault during the warranty period.

This warranty excludes damage caused by misuse, neglect, shipping accident, incorrect installation, or work carried out by anyone other than a qualified electrical service technician.

PLEASE KEEP YOUR RECEIPT AS THIS WILL HELP VERIFY YOUR WARRANTY.

The benefits given to you by this warranty are in addition to other rights and remedies available to you under law in relation to the goods or services to which this warranty relates.

In Australia, our goods come with guarantees that cannot be excluded under the Australian Consumer Law. You are entitled to a replacement or refund for a major failure and compensation for any other reasonably foreseeable loss or damage. You are also entitled to have the goods repaired or replaced if the goods fail to be of acceptable quality and the failure does not amount to a major failure.

In New Zealand this warranty is additional to the conditions and guarantees of the Consumers Guarantee Act (1993).

Goldair – New Zealand

CDB Goldair
PO Box 100-707
N.S.M.C
Auckland
Phone +64 (0)9 917 4000
Phone 0800 232 633
www.goldair.co.nz

Goldair – Australia

CDB Goldair Australia Pty
PO Box 574
South Morang
Victoria, 3752
Phone +61 (0)3 9365 5100
Phone 1300 GOLDAIR (1300 465 324)
www.goldair.com.au

Goldair Three Year Warranty (IMPORTANT: Please complete and retain this warranty card)

Name _____

Address _____

Place Of Purchase _____ Date Of Purchase _____

Name Of Product _____ Model Number _____

Attach a copy of the purchase receipt to this warranty card

Goldair™

PLATINUM



CDB  Goldair™

New Zealand
PO Box 100707,
North Shore Mail Centre,
Auckland, 0745
www.goldair.co.nz

Australia
PO Box 574,
South Morang,
Victoria, 3752
www.goldair.com.au