





LA SERRATURA SENZA MANIGLIA
THE LOCK WITHOUT HANDLE

VANTAGGI / ADVANTAGES

 design: il pannello della porta è totalmente liscio
design: the side of the door is completely smooth

 silenziosità e fluidità durante l'apertura e la chiusura della porta
silence and fluidity during opening and closing of the door

 resistenza all'ossidazione
oxidation resistance

 affidabilità: pochi componenti sono in movimento
reliability: only a few moving elements

 sicurezza per i bambini: nessun rischio d'urto
safety for children: no shock risk

 nessuna manutenzione richiesta
no maintenance required

→ Entrata / Backset

privacy: 28 mm

 Versioni / Versions

privacy
passage

 Frontale / Front plate

altezza / height: 190 mm
larghezza / width: 22 mm
spessore / thickness: 2.5 mm

 Quadro / Follower

privacy: 6 mm

 Materiale / Material

ottone / brass

 *Distanza / Distance

4 mm

 Su richiesta / On demand

accessori / accessories

- cover / cover
- pomoli / knobs
- fresa speciale / special tool: \varnothing 44 mm

* massima distanza consigliata tra anta e telaio
maximum distance recommended between leaf and frame

LE SERRATURE / THE LOCKS



mod. 938

PASSAGE



mod. 937

PRIVACY

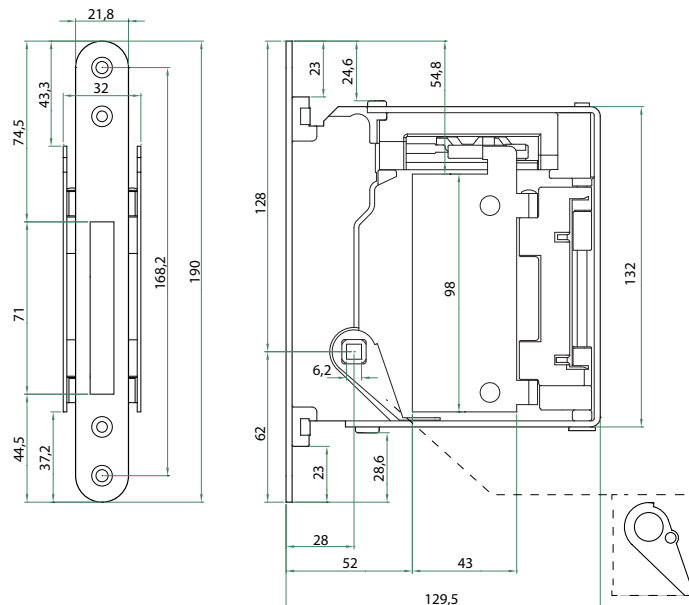

Spessore porta
Door thickness

MIN 40 mm
MAX 48 mm

**LE CONTROPIASTRE REGOLABILI
THE ADJUSTABLE STRIKING PLATES**



G992

GR95

G992 Misure / Dimensions

altezza / height: 190 mm
larghezza / width: 22 mm
spessore / thickness: 2 mm

GR95 Misure / Dimensions

altezza / height: 82 mm
larghezza / width: 22 mm
spessore / thickness: 4 mm

G992 Materiale / Material

ottone / brass

GR95 Materiale / Material

acciaio / steel

GLI ACCESSORI SU RICHIESTA / THE ACCESSORIES ON DEMAND

1 LA COVER
THE COVER



La Cover è progettata per integrarsi perfettamente a tutti i nostri sistemi NO-HA mini, ed è disponibile in MDF e in metallo. Le versioni in MDF (con colorazione neutra) sono poi verniciabili, mentre le Cover metalliche sono disponibili in inox satinato. In questo modo si integra perfettamente il design della porta con le finiture dei frontali o del pannello porta utilizzato.

The Cover is designed to perfectly integrate to all our NO-HA mini systems and is available in MDF and metal. The MDF (with neutral colouring) are then paintable while the metal plates covers are available in satin stainless steel. This integrates perfectly the door design with the finishes of the door locks or the door panel used.

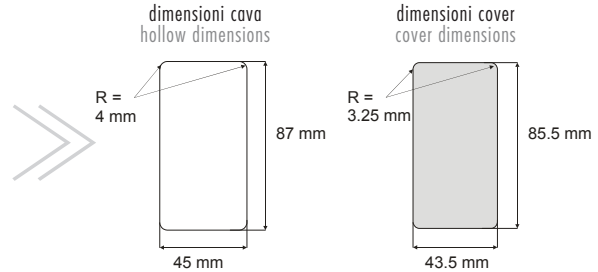

+ PERSONALIZZAZIONE COLORI E FORME

La forma e i colori standard Bonaiti sono sopra descritti. Il cliente è libero di personalizzare colore e forma con il proprio falegname di fiducia.

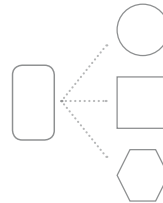

+ COLORS AND SHAPES CUSTOMIZATION

The Bonaiti standard shape and colours are described above. The customer is free to customize the color and the shape with his trusted carpenter.

2 I POMOLI PER LA VERSIONE PRIVACY
THE KNOBS FOR PRIVACY VERSION

Il pomolo cieco Cartel è stato sviluppato appositamente per le serrature NO-HA mini versione privacy, per mantenere il look della porta il più minimalista possibile. I materiali utilizzati per la realizzazione di questo prodotto sono stati progettati per non disturbare in nessun caso il corretto funzionamento del magnetismo che comanda il sistema della serratura. È disponibile nelle finiture ottone lucido verniciato, ottone cromato lucido e inox spazzolato.

The blind Cartel Knob has been specially developed for the B NO-HA mini locks version privacy, to guarantee the minimalist look of the door. The materials used for the realization of this product have been designed not to disturb in any case the correct functioning of the magnetism that operates the lock system. It's available in polished varnished brass, polished chromed brass and brushed stainless steel finishes.

mod. PH1



solo lato interno
only inner side
∅ 6 mm

I pomoli con vite d'emergenza hanno la possibilità di montare un pomolo normale passante senza rosette con vite d'emergenza lato esterno e con pomolo lato interno della porta per le serrature NO-HA mini versione privacy. È disponibile nei modelli e nelle finiture da nostro catalogo delle maniglie.

Possibility to mount a normal side by side knob without rosettes with emergency screw on the outer and with knob on the inner side of the door for the NO-HA mini privacy version. It is available in the models and finishes from our catalog of the handles.

mod. 315



mod. 302



mod. 310



passanti
side by side

∅ 6 mm

3 LA FRESA SPECIALE
THE SPECIAL TOOL



L'utensile fresa da 44 mm di diametro è lo strumento ideale sulle macchine utensili per la creazione delle cave dell'alloggiamento dei vari sistemi NO-HA mini, Single e Double. Utilizzando questo strumento sul pannello porta si riesce a creare in un solo percorso macchina la sagoma necessaria per alloggiare correttamente tutti i sistemi NO-HA mini.

The special tool 44 mm diameter is the ideal instrument on CNC machines for the creation of the pit housing of the various NO-HA mini systems, Single and Double.

By using this tool on the door panel you can create with a single machine working step the necessary template to properly install all NO-HA mini systems.

