

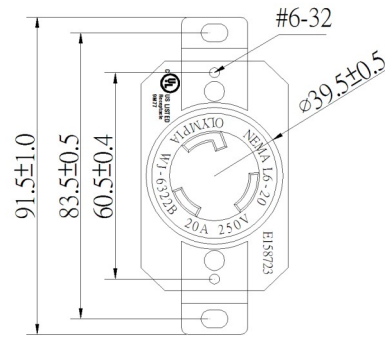

NEMA L6-20 Locking Receptacle

Technical Datasheet



Product Specifications	
Product Item	Single Receptacle Locking Type
Rating	2 Pole, 3Wire Grounding 20A 250V AC
NEMA Configuration	L6-20R
Color	Black
Contact Material	All contact are brass, 0.050"(1.3m/m) thick.
Terminal Screw Material	#10 solid brass
Ground Screw Material	#10 solid brass (Green)
Cover (Top) Material	P.B.T. (Poly Butylene Terephthalate Resin) 94V-0
Base Material	P.B.T. (Poly Butylene Terephthalate Resin) 94V-0
Listings	UL/cUL E158723