











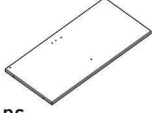

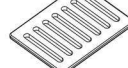
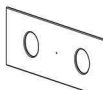
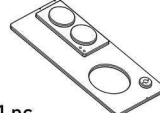

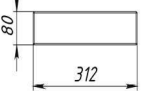

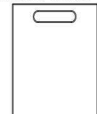
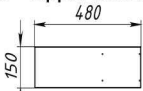
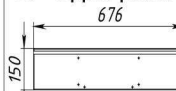
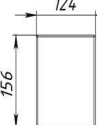
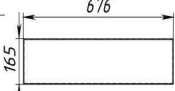
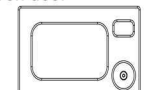
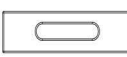
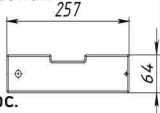
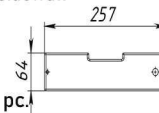
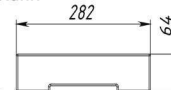
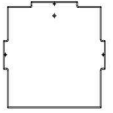





Toy kitchen "Creative cooking"



ASSEMBLY PARTS

1 - Left sidewall  1 pc.	2 - Right sidewall  1 pc.	3 - Lower base  1 pc.	4 - Lintel  1 pc.	5 - Baking tray  1 pc.	6 - Back wall  2 pcs.	7 - Tabletop  1 pc.
8 - Front panel  1 pc.	9 - Owen door  1 pc.	10 - Plank  1 pc.	11 - Kitchen sink  1 pc.	12 - Cabinet door  1 pc.	13 - Upper sidewall  2 pc.	14 - Upper plank  2 pc.
15 - Upper lintel  2 pcs.	16 - Upper plank  1 pcs.	17 - Microwave oven door  1 pc.	18 - Drawer facade  1 pc.	19 - Left drawer sidewall  1 pc.	20 - Right drawer sidewall  1 pc.	21 - Drawer back plank  1 pc.
22 - Lower drawer plank  1 pc.	23 - Under-the-drawer plank  1 pc.	24 - «Ericson» nut  2 pcs.	25 - Confirmat screw  45 pcs.	26 - 3 mm hex key  1 pc.	27 - 4 mm hex key  2 pcs.	28 - Set of minifixe  8 pcs.
29 - Screwdriver  1 pc.	30 - Self-tapping screw 3x12 mm  12 pcs.	31 - Shelf holder  6 pcs.	32 - Screw with a flat head M6x20  2 pcs.	33 - Plastic lock  3 pcs.	34 - Plastic bucket  1 pc.	35 - Plastic bottle  1 pc.
36 - Electric pump  1 pc.						

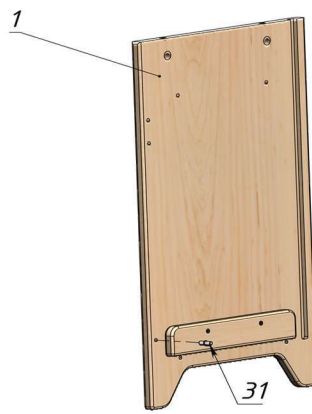

Pic. 1

Take the Left sidewall (1) and install the Shelf-holders (31) as shown in the picture 1.

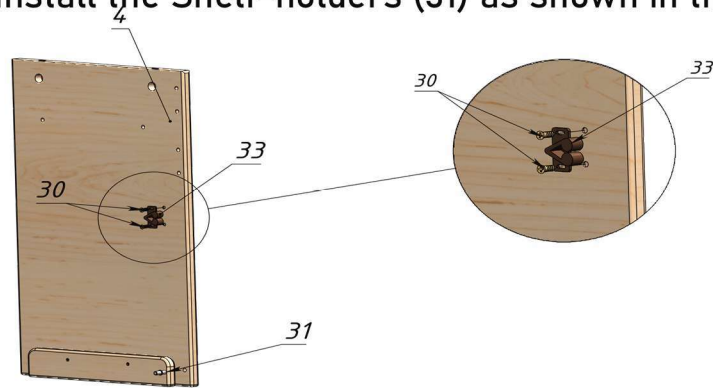

Pic. 2

Take the Lintel (4) and using the Self-tapping screws (30), connect the Plastic lock (33) and install the Shelf-holder (31). See Pic. 2

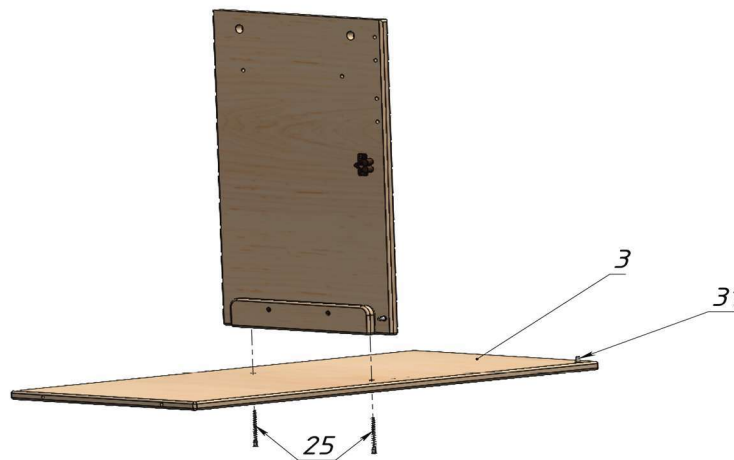

Pic. 3

Using the Confirmat screws (25) and 3 mm hex key (26), connect the Lower base (3) to the previously assembled construction. Then insert the Shelf-holder (31). See Pic. 3

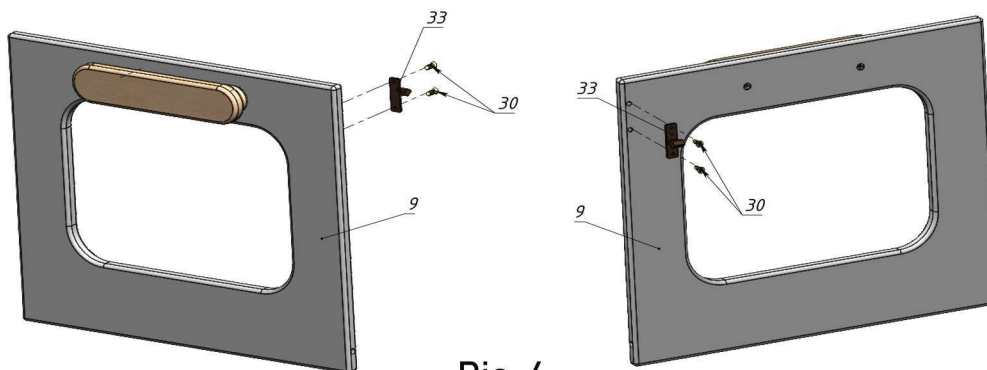

Pic. 4

Now take the Owen door (9) and using the Self-tapping screws (30) and a Screwdriver(29), connect the Plastic locks (33). See Pic.4

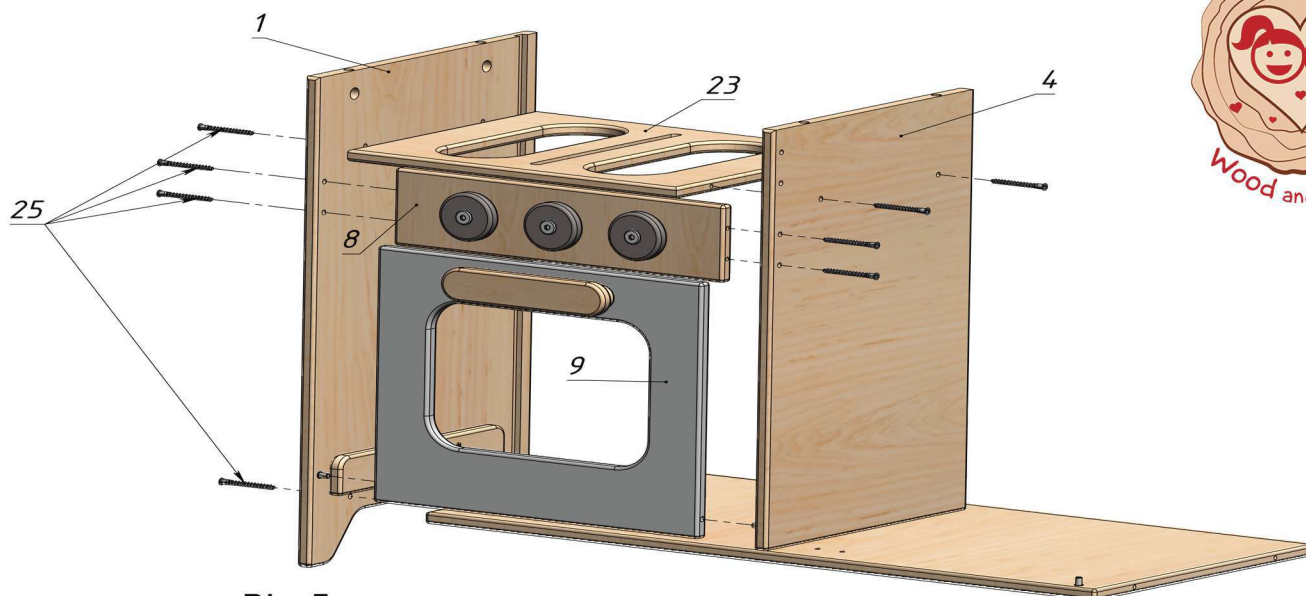

Pic. 5

Take the Confirmat screws (25) and a 3 mm hex key (26) and connect the Front panel (8) and Under-the-drawer plank (23) to the Lintel (4). The Oven door (9) is to be connected to the Shelf-holder (31) on the Lintel (4). Fix the Left sidewall (1) with the confirmat screws (25). See Pic. 5

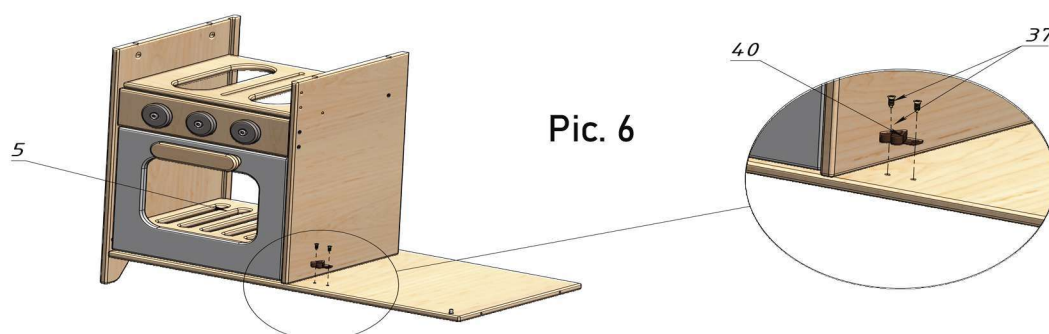

Pic. 6

Using the Self-tapping screws (30) and a Screwdriver (29), fix the Lock (33). Then install the Baking tray (5). See Pic. 6.

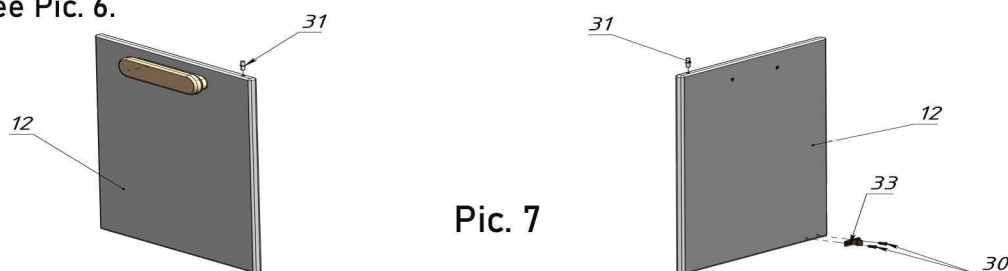

Pic. 7

Take the Cabinet door (12) and fix the Lock (33) with the Screws (30). Insert the Shelf-holders (31). See Pic. 7

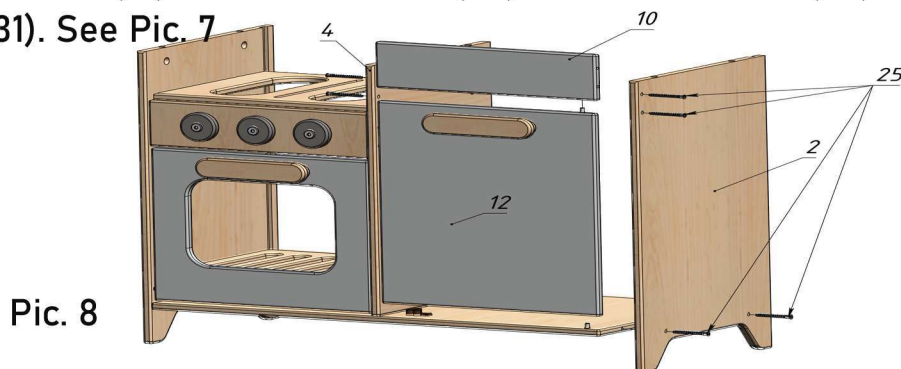

Pic. 8

Locate the Cabinet door (12) on the Shelf-holder (31) on the Lower base (3). Then install the Plank (10) and screw with the Confirmat screws (25) from the side of a Lintel (4). Connect the Right sidewall (2) to the assembled structure with the Confirmat screws (25). See Pic. 8

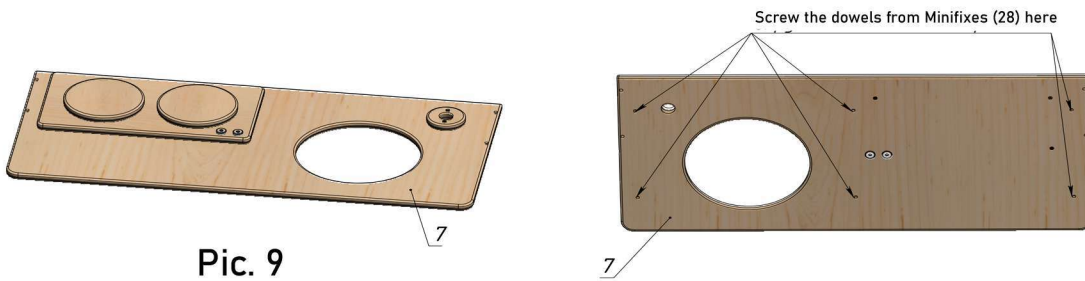

Pic. 9

Take the Tabletop (7) and using the Screwdriver (29), screw the dowels from Minifixes in. See Pic. 9

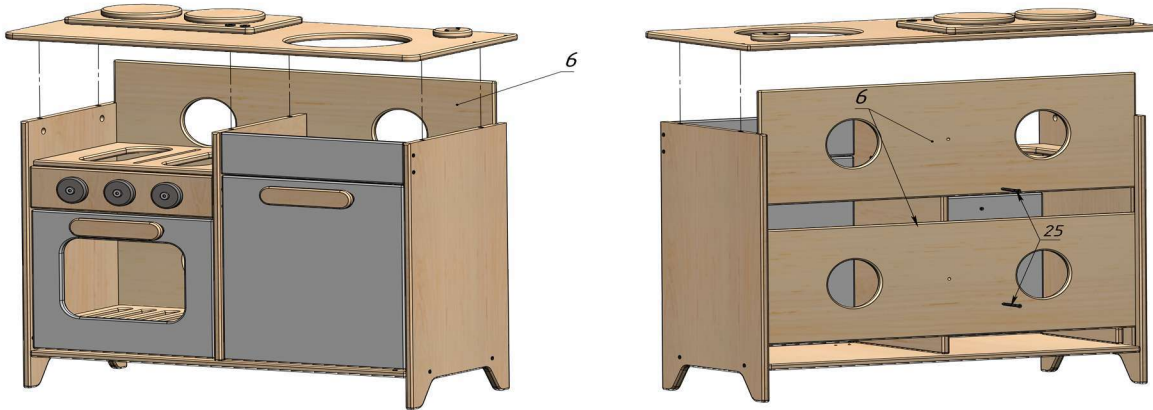

Pic. 10

Insert the Back walls (6) into the gooved of Sidewalls (1,2) and screw them with the Confirmat screws (25). Then install the Tabletop (7) onto the previously assembled construction and close the Eccentrics (28) on the Sidewalls (1,2) and a Lintel (4) clockwise. See Pic.10

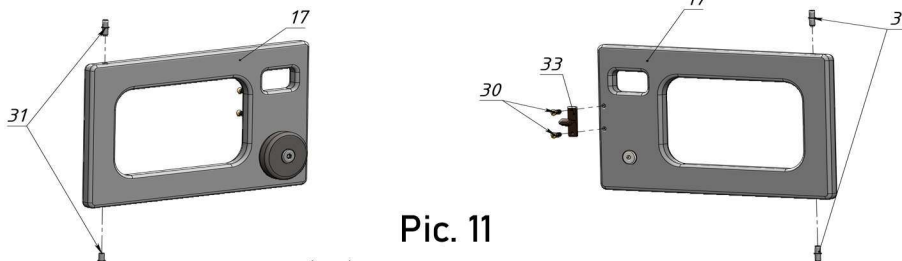

Pic. 11

Take the Microwave oven door (17) and using the Self-tapping screws (30), fix the Lock (33). Above and beneath the detail 17, insert the Shelf-holders (31). See Pic. 11

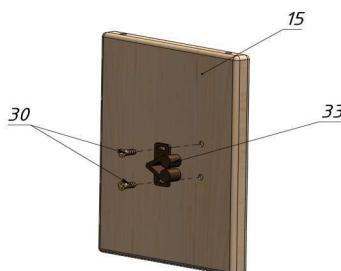

Pic. 12

Connect the lock to one of the Upper lintels (15) with the Screws (30). See Pic. 12

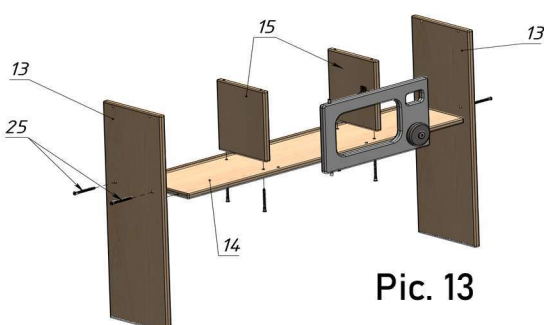

Pic. 13

Connect the Upper lintels (15) to one of the Upper planks (14), using the Confirmat screws (25). Then connect the Upper sidewalls (13) the same way. Insert the Microwave oven door (17) with the Shelf-holder into the Upper plank (14). See Pic.13

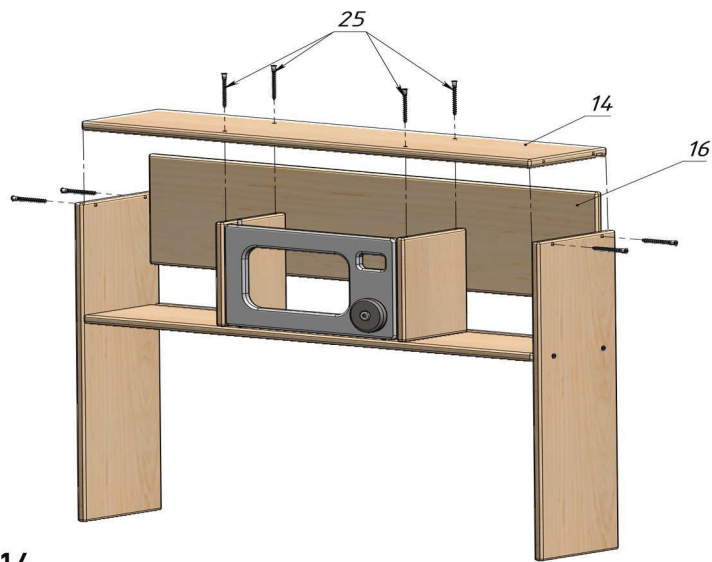

Pic. 14

Take the previously assembled construction and insert the Upper plank (16) into the groove on the Upper plank (14). Then put another detail 14 above and screw together with Confirmat screws (25). See Pic. 14

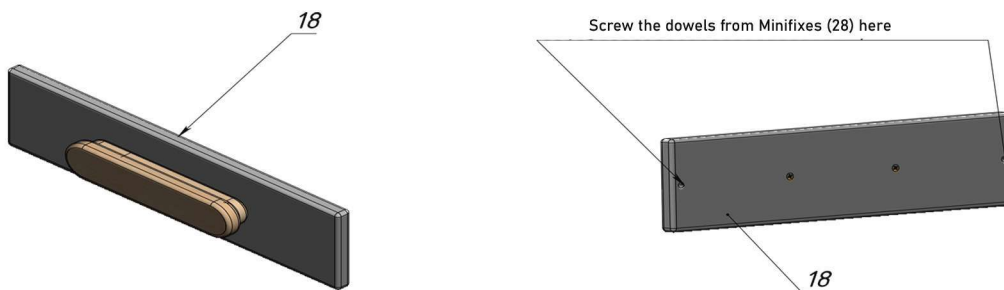

Pic. 15

Take the Drawer facade (18) and using the Screwdriver (29), fix the dowels from Minifixes (28). See Pic. 15

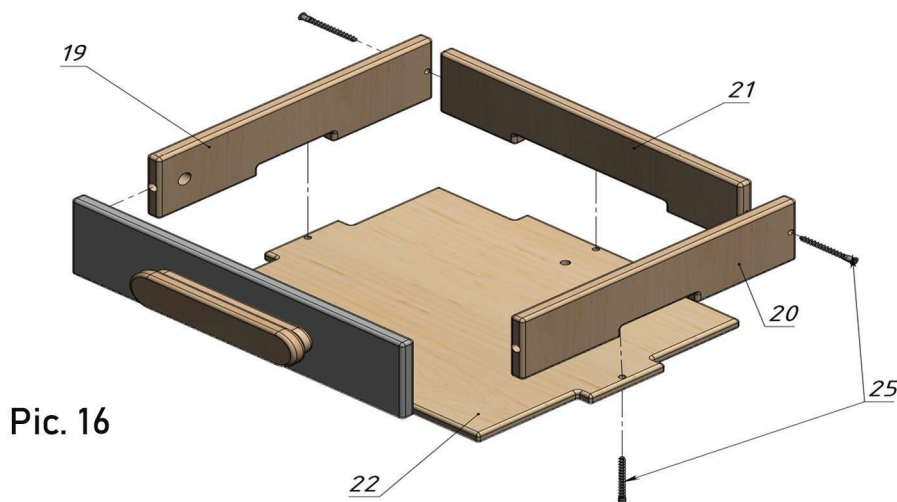

Pic. 16

Take the Lower drawer plank (22) and using the Confirmat screws (25), fix the Sidewalls and Back plank of a drawer (19,20,21). Install the Drawer facade (18) into the assembled construction and close the Eccentrics of Minifixes (28) located on details 19 and 20 with Screwdriver (20) clockwise. See Pic. 16

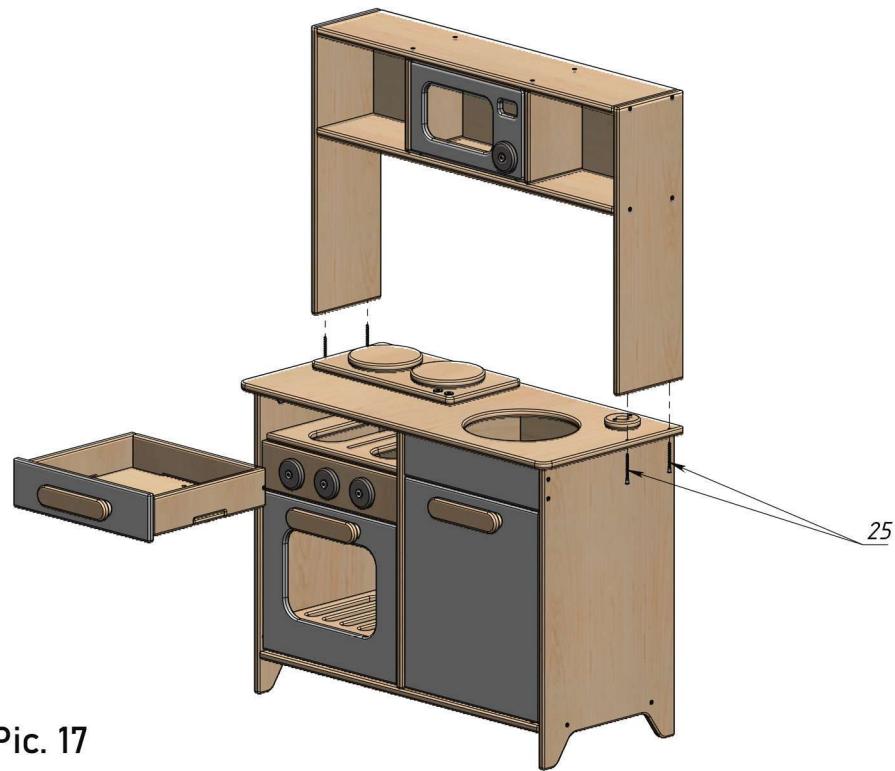

Pic. 17

Screw together 2 assembled structures with Confirmat screws (25) and insert a drawer. See Pic. 17

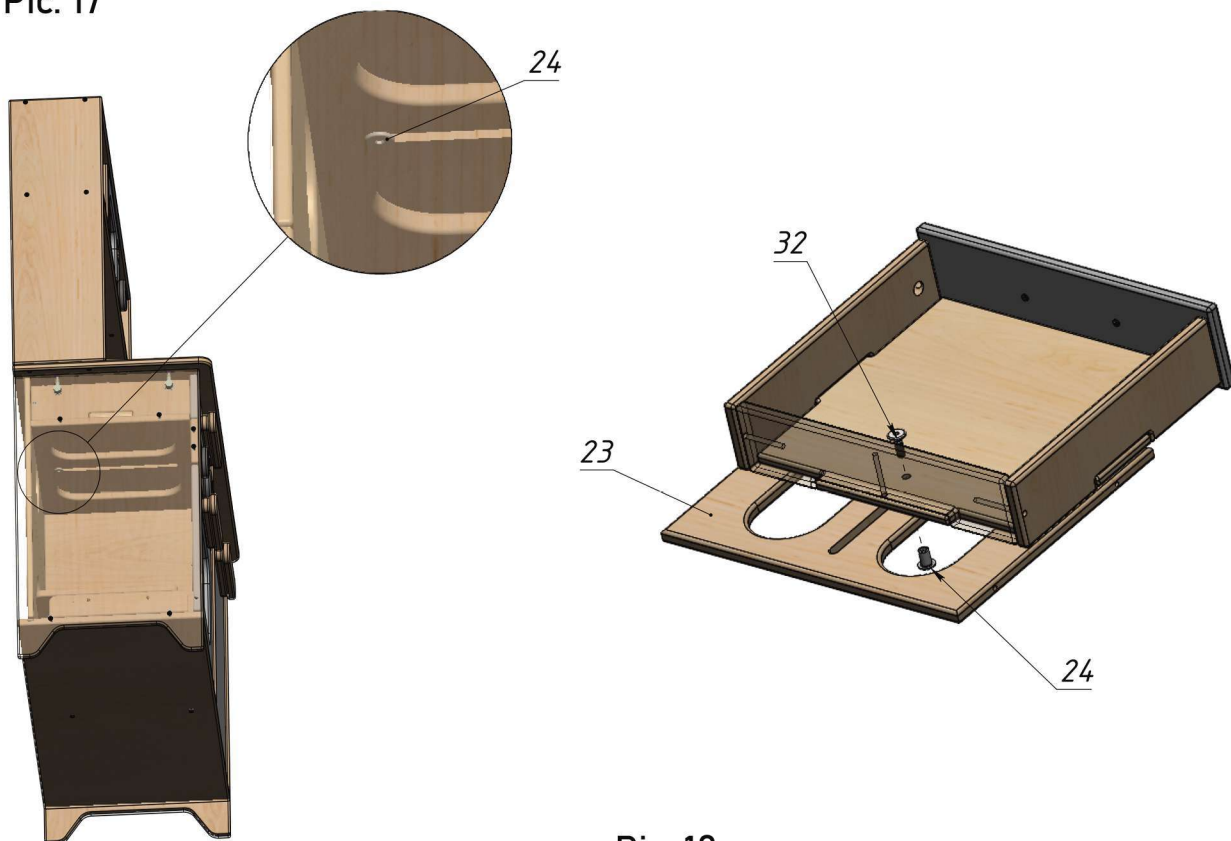

Pic. 18

To prevent the drawer from falling out, screw it together with the Under-the-drawer plank (23) with the help of a Nut (24), screws (32) and both 4 mm hex keys (27). See Pic. 18

**To be used under the direct supervision of an adult only.
Always be vigilant during children's games.**