

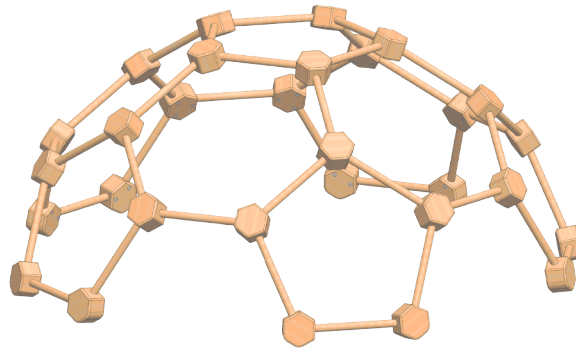

"Spider" climber

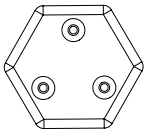
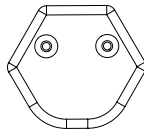
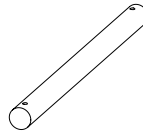

ASSEMBLY DETAILS

<p>1 - Hexagon for 3 nogs</p>  <p>20 pcs.</p>	<p>2 - Hexagon for 2 nogs</p>  <p>10 pcs.</p>	<p>3 - Nog</p>  <p>40 pcs.</p>	<p>a - Screw 6.3x50</p>  <p>80 pcs. + 5 spare</p>	<p>b - 4mm hex key</p>  <p>1 pc.</p>
--	--	---	--	---

Assemble the lower hexagon:

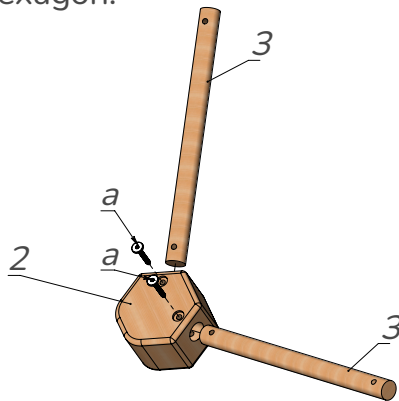

Pic. 1

Take one of the hexagons for 2 nogs (2) and install the nog (3) in it fully to get such a position, so that the holes of the wooden hexagon matched the holes of the nog. Join the details with the screw (a) using the hex key (b). See Pic.1.

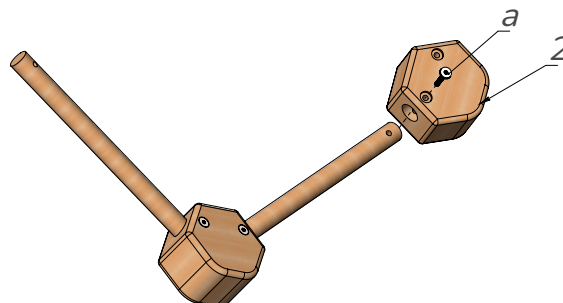

Pic. 2

To the receive construction attach another wooden hexagon for 2 nogs(2) and fix it with the screws (a). See Pic.2.

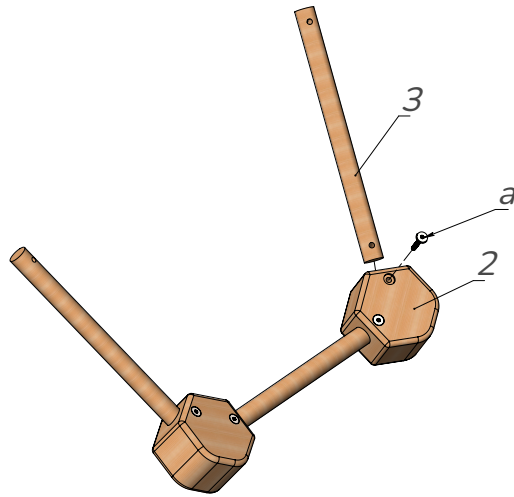

Pic. 3

Attach another nog (3) to the detail 2 using the screws (a). See Pic.3.

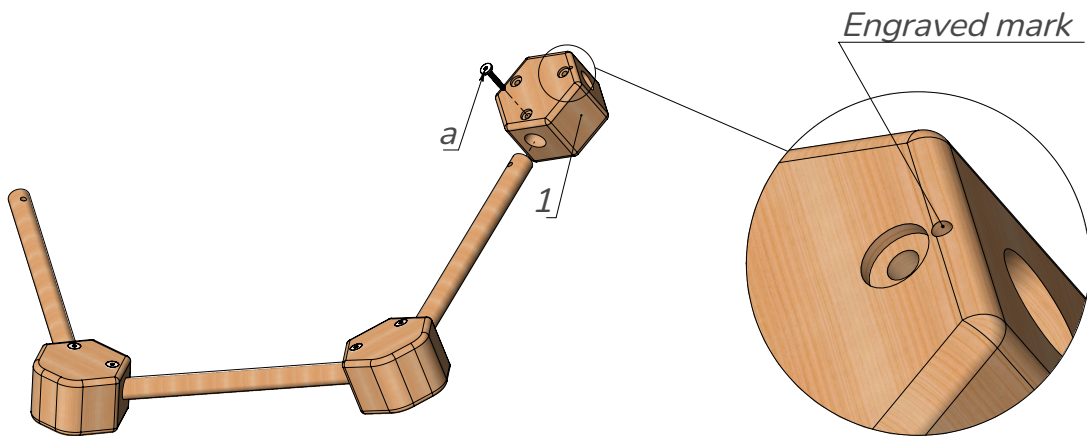

Pic. 4

Attach the wooden hexagon for 3 nogs (1) to the previously assembled construction. It should be located in such a way, so that engraved mark looked outside the construction. See Pic.4.

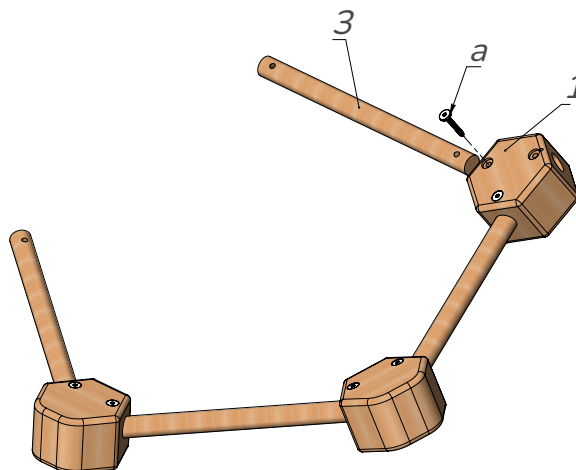

Pic. 5

Attach another detail 3 using the screw (a) and hex key (b) to the hexagon for 3 nogs (1). See Pic.5.

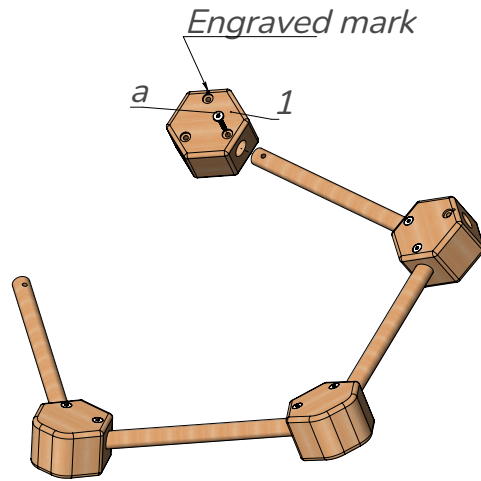

Pic. 6

Attach the hexagon for 3 nogs (1) to the received construction in a way, so that the engraved mark looked outside the construction, and fix with the screw (a). See Pic.6.

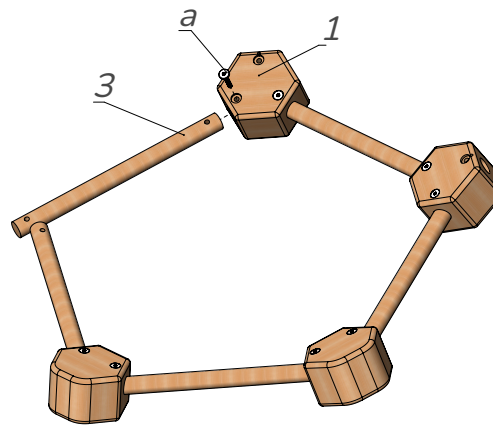

Pic. 7

Attach another detail 3 using the screw (a) and hex key (b) to the hexagon for 3 nogs (1). See Pic.7.

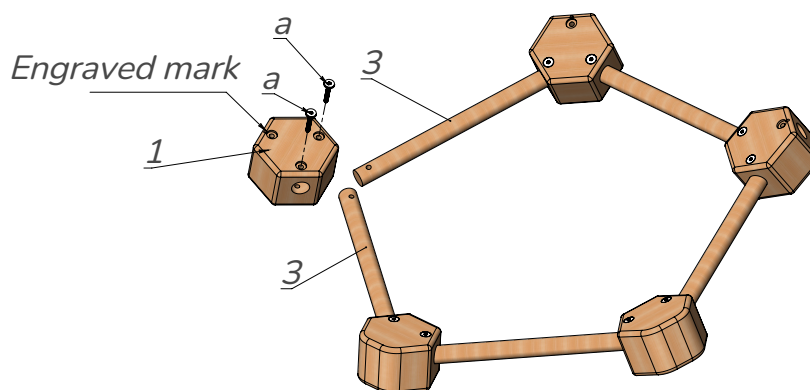

Pic. 8

Install the wooden hexagon for 3 nogs. Hole with engraving should be located on the outside. Join with the screws (a). See Pic.8.

Assemble 5 such hexagons.

Then assemble the upper hexagon part of the construction.

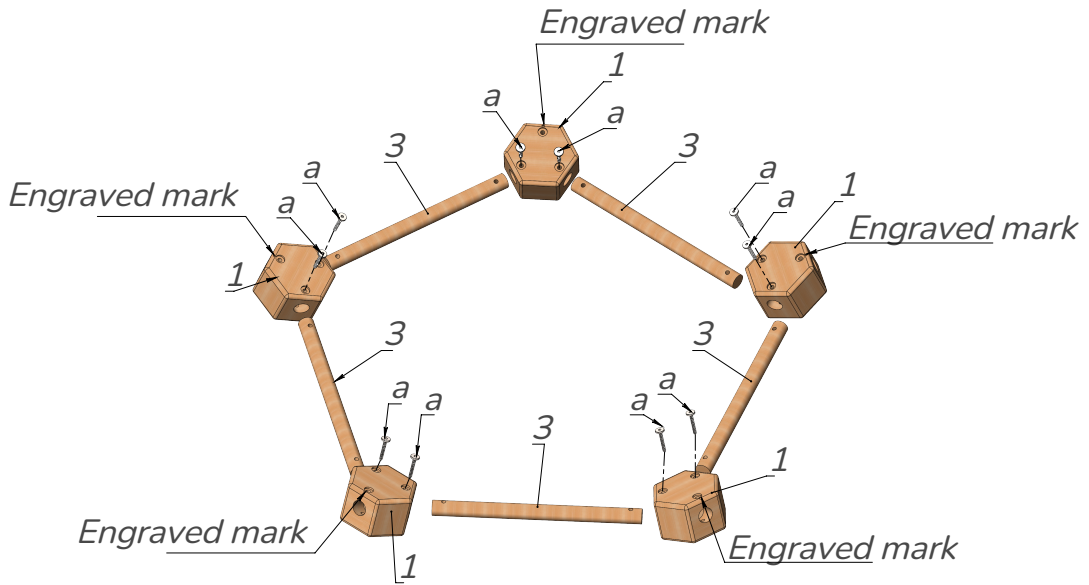

Pic. 9

It is to be assembled in a same way as the lower hexagon parts. Use the wooden hexagons for 3 nogs (1) and nogs (3). Fix with the help of screws (a) and hex key (b). Hole with engraving in the details 1 should look outside. See Pic.9.

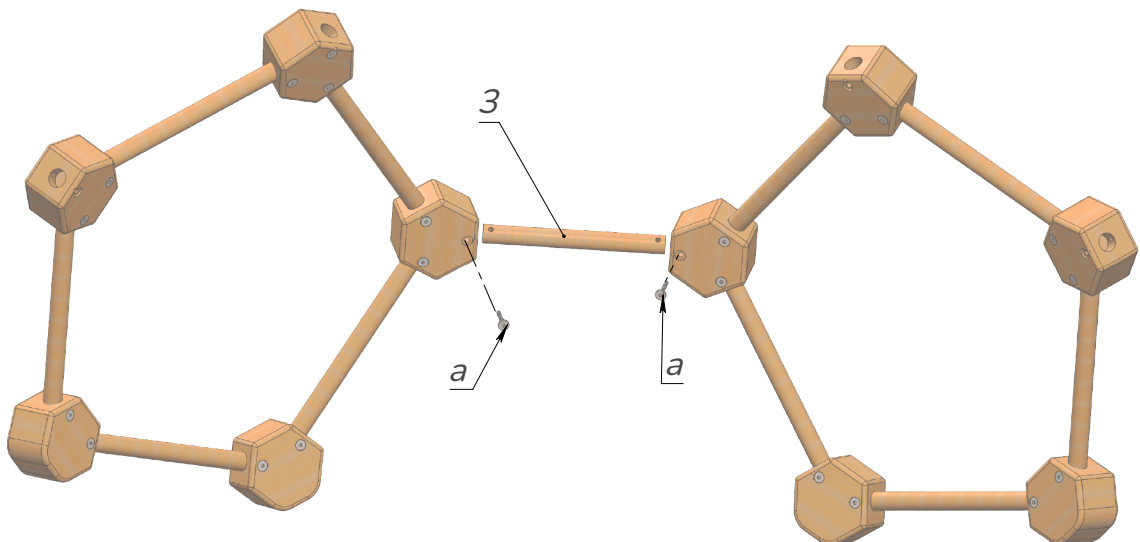

Pic. 10

Sequentially join the hexagonal details depicted in the Pic.8 with the help of nogs (3). Fix them with the screws (a). See Pic.10.

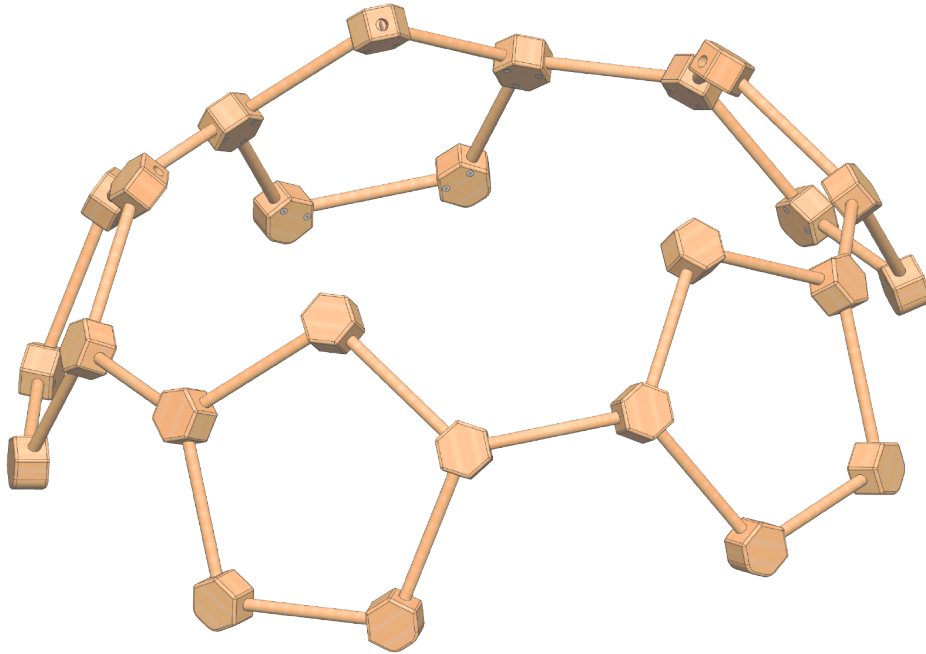

Pic. 11

After attaching all 6 hexagonal parts you will receive the following construction. See Pic.11.

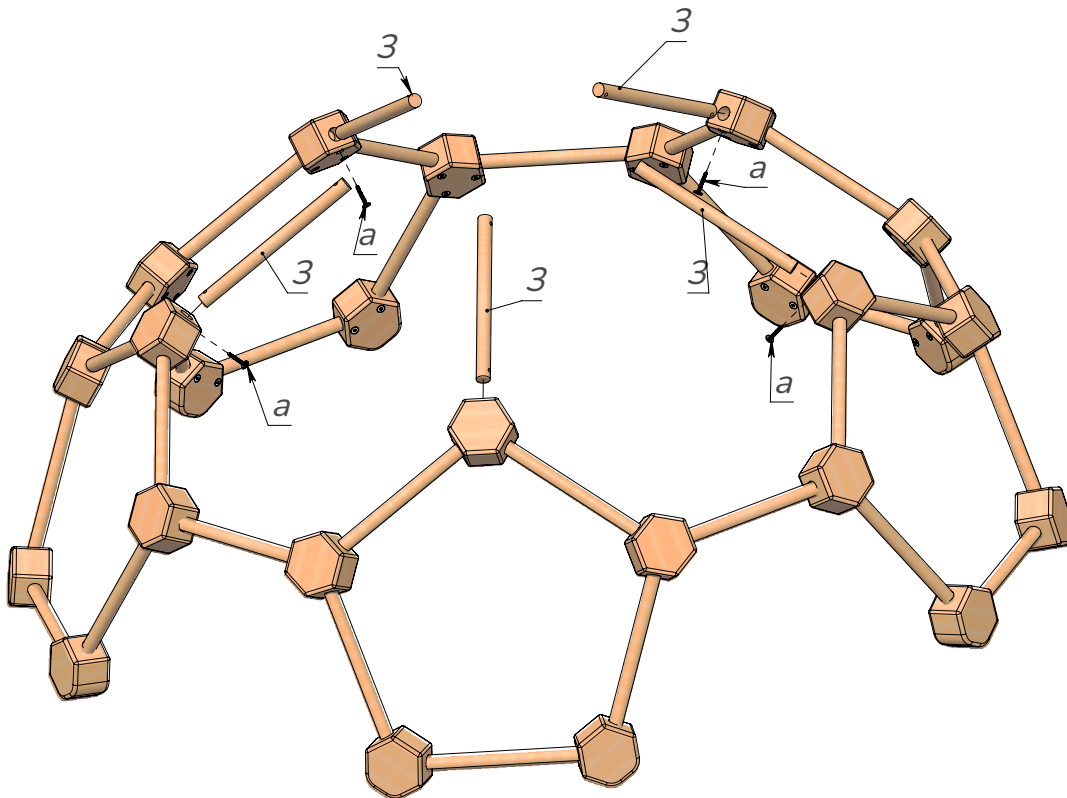

Pic. 12

Attach the nogs (3) to previously assembled construction using the screws (a) and hex key (b). See Pic.12.

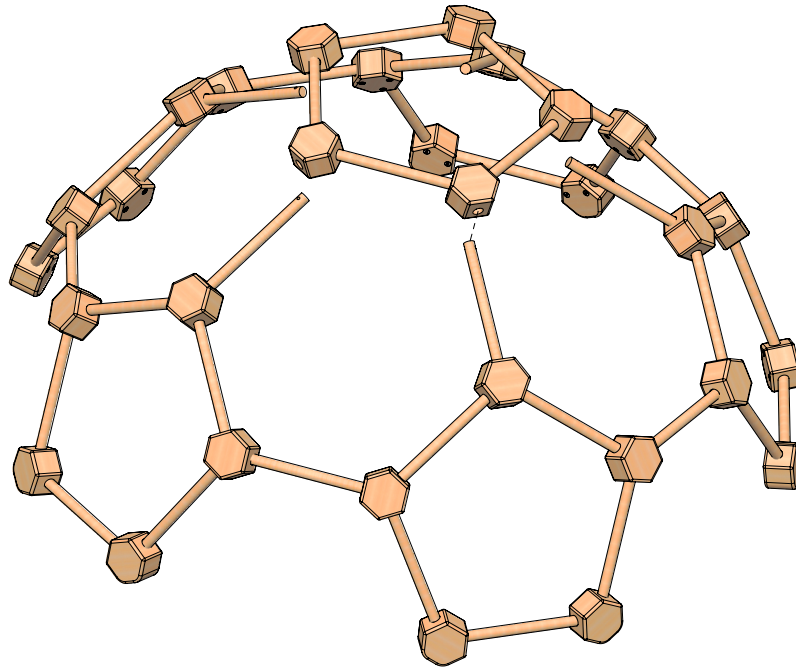

Pic. 13

Join the previously assembled construction and the upper hexagon part, depicted in the Pic.9. See Pic.13.

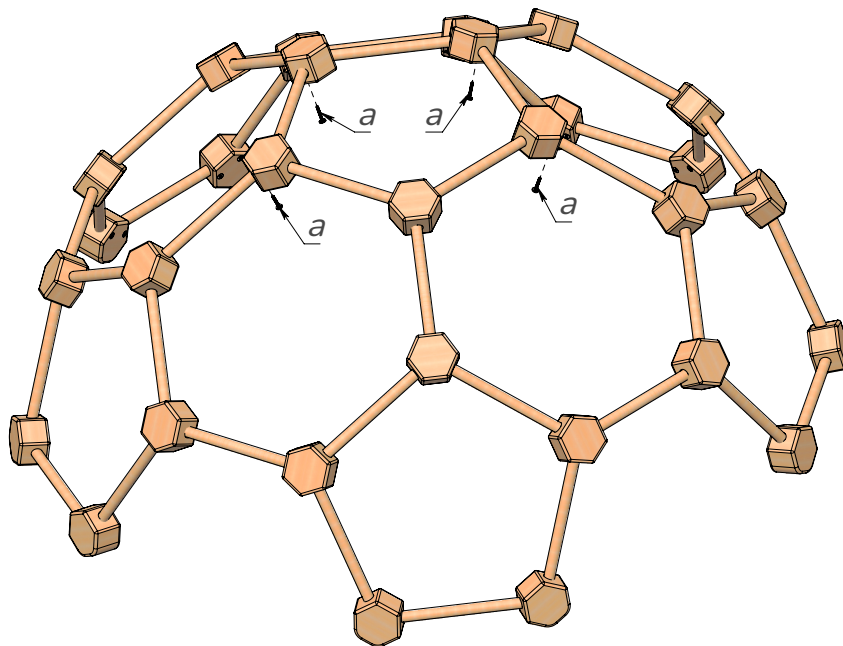

Pic. 14

Fix the received construction with the screws (a) using hex key (b). See Pic.14.



To be used for its intended purpose only and under the direct supervision of an adult!
All the responsibility for children's injuries received during games on the furniture lies on adults watching after them.

Always be vigilant during children's games!