

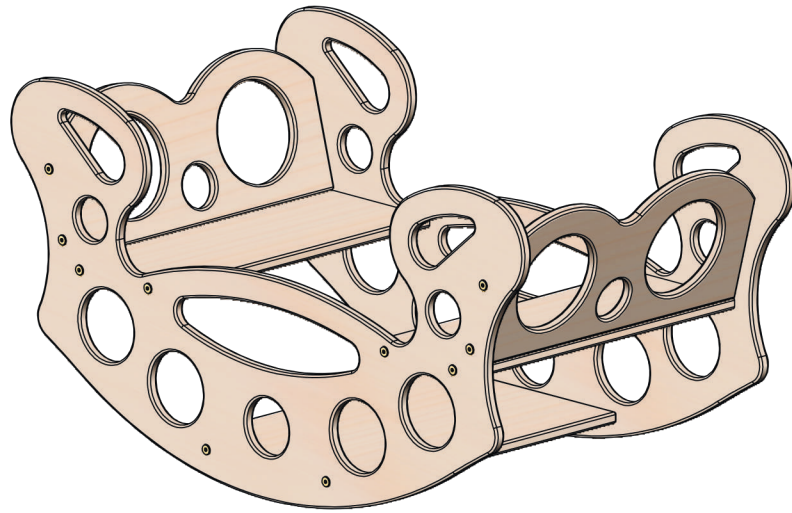

## ROCKING TABLE ASSEMBLED

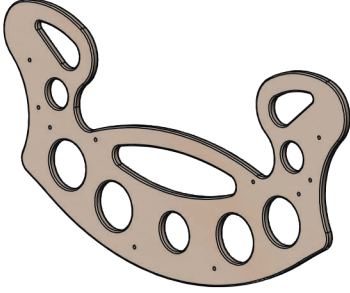
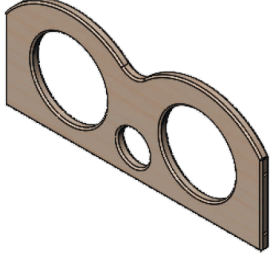
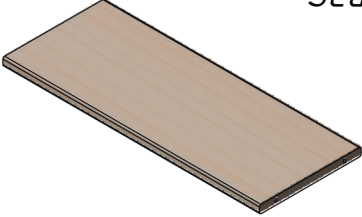
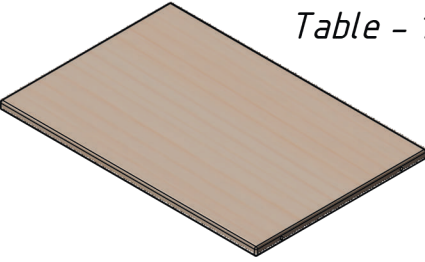

### ASSEMBLY PARTS

<p>1.1</p> <p><i>SideWall - 2pcs</i></p> 	<p>1.2</p> <p><i>Back - 2pcs</i></p> 
<p>1.3</p> <p><i>Seat - 2pcs</i></p> 	<p>1.4</p> <p><i>Table - 1pcs</i></p> 
<p>2.1</p>  <p><i>Flat head screw 21pcs(20pcs.+1spare)</i></p>	<p>2.2</p>  <p><i>4mm hex key - 1pc</i></p>

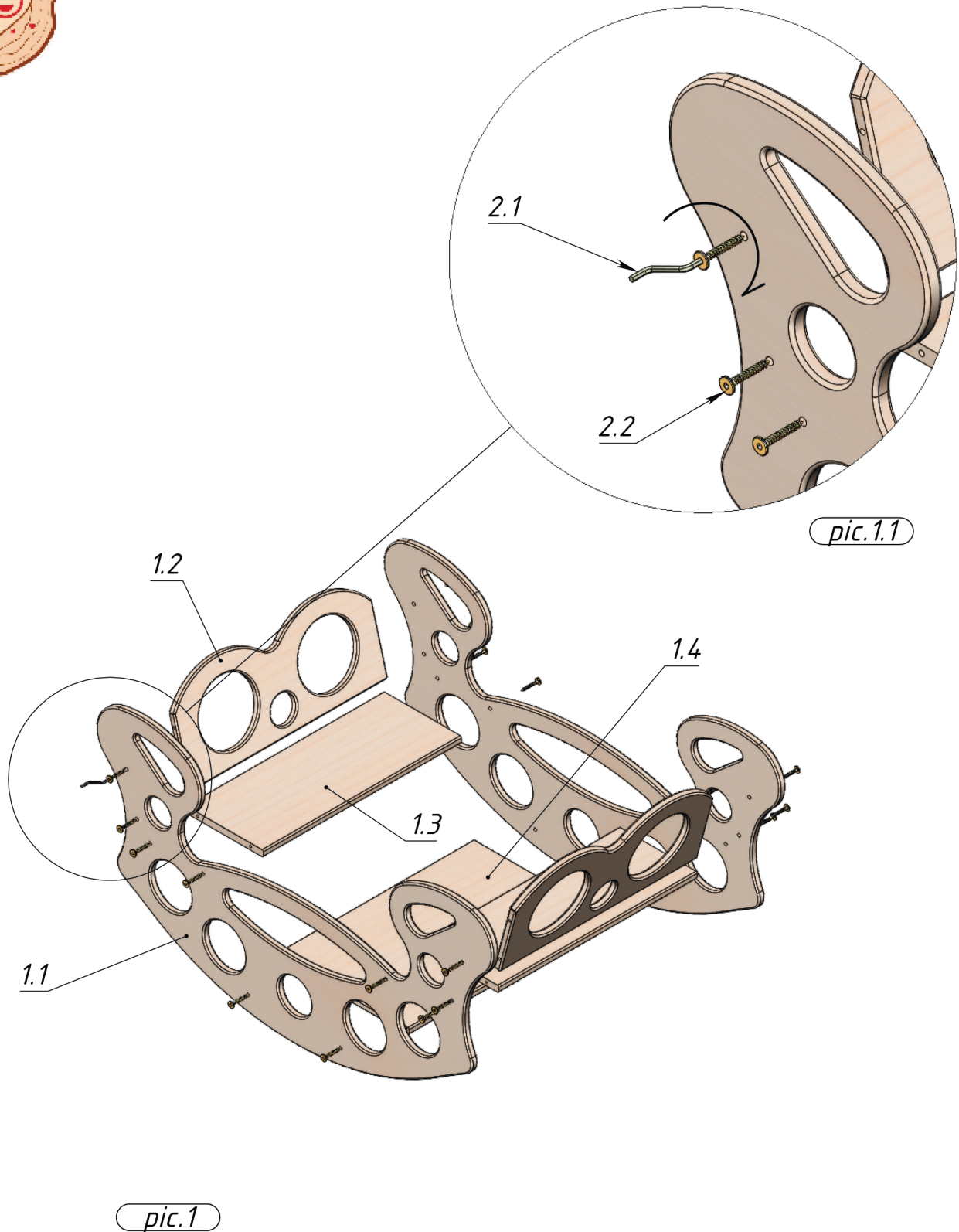
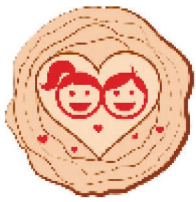

1. Take two sidewalls (1.1) , Backs (1.2), Seats (1.3) and a Table (1.4)). (page 1).
2. Fasten the parts with 2.1 screws as shown in picture 1 (pic.1.1) using the hex key 2.2

**To be used under the direct supervision of an adult only.  
Always be vigilant during children's games**

**Any questions? Contact us: [support@woodandhearts.com](mailto:support@woodandhearts.com)**