

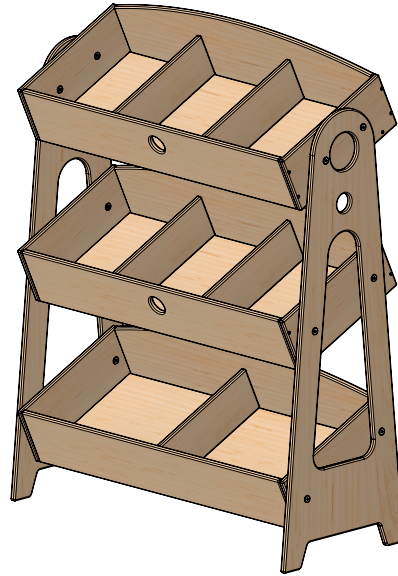

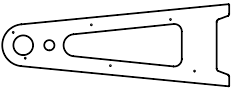

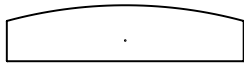

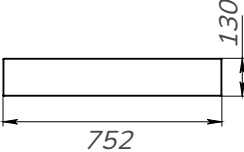
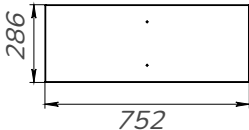
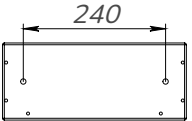
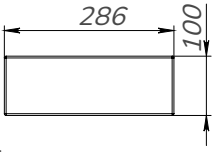
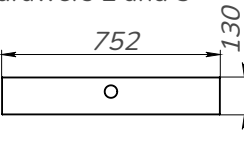
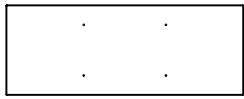

Full-storage shelf

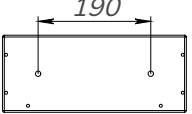
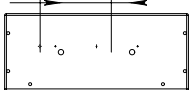

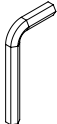
ASSEMBLY DETAILS

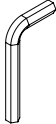
<p>1 - Side panel</p>  <p>2 pcs.</p>	<p>2- Back wall of the lower drawer</p>  <p>1 pc.</p>	<p>3 - Front lower leg</p>  <p>1 pc.</p>	<p>4 - The base of the lower drawer</p>  <p>1 pc.</p>	<p>5 - Side wall of the lower drawer</p>  <p>2 pcs.</p>
<p>6 - Divider</p>  <p>5 pcs.</p>	<p>7 - Front wall of drawers 2 and 3</p>  <p>2 pcs.</p>	<p>8 - The base of drawers 2 and 3</p>  <p>2 pcs.</p>	<p>9 - Back wall of drawers 2 and 3</p>  <p>2 pcs.</p>	<p>10 - Side wall of the middle box</p>  <p>2 pcs.</p>
<p>11 - Side wall of the upper drawer</p>  <p>2 pcs.</p>	<p>a - Confirmat screw 5x40</p>  <p>51 pcs.</p>	<p>b - 3mm Hex key</p>  <p>1 pc.</p>	<p>c - Ericson Nut M6x9</p>  <p>12 pcs.</p>	<p>d - Screw M6x20</p>  <p>12 pcs.</p>
<p>c - 4mm Hex key</p>  <p>1 pc.</p>	<p>f - 5mm Hex key</p>  <p>1 pc.</p>			

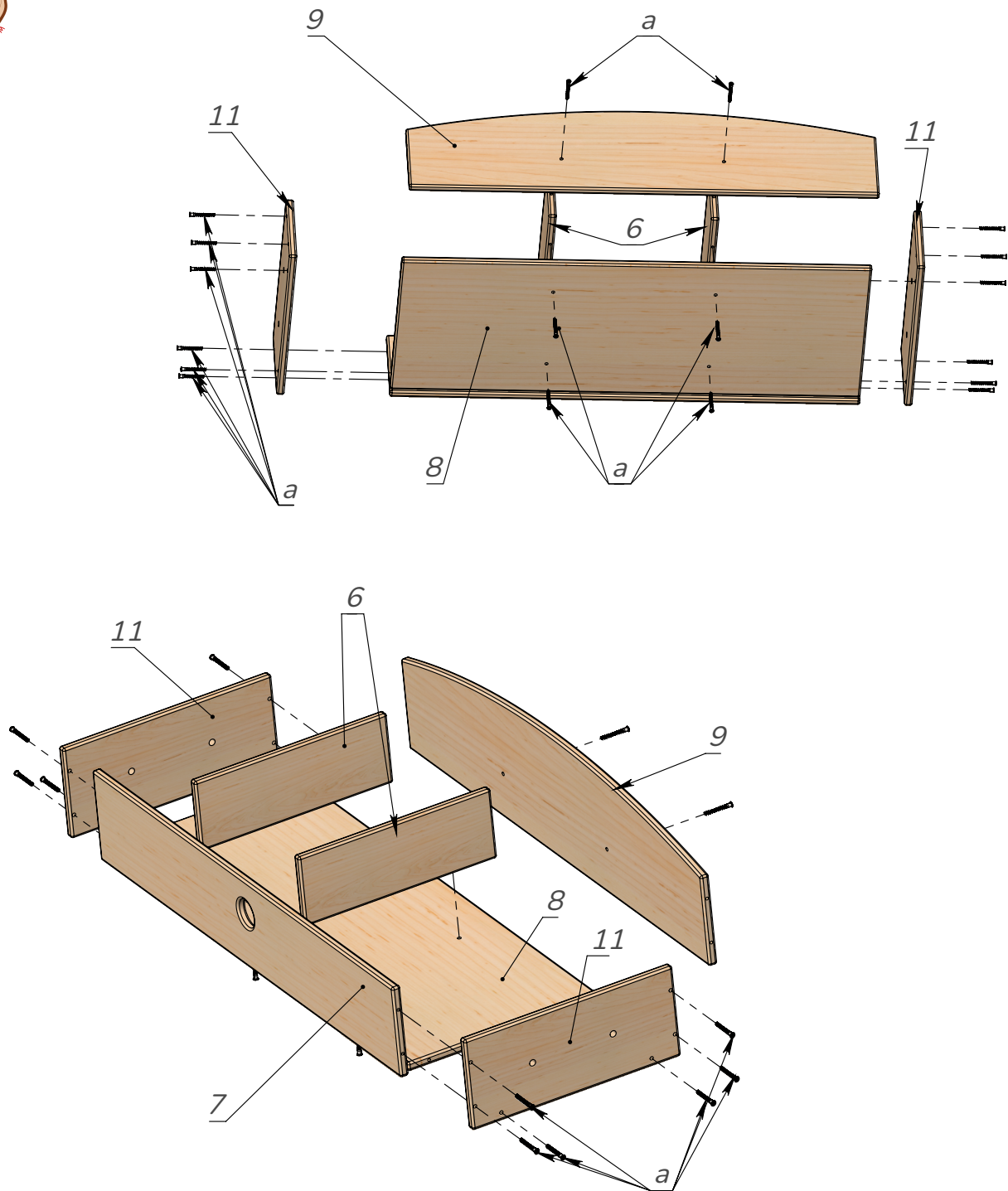

Pic. 1

Assemble the per box: take the the base of drawers 2 and 3 (8) and screw the dividers (6) to itwith the help of confirmats (a) and a hex key (b). Then screw the back wall of drawers 2 and 3 (9) to dividers (6) with confirmats (a). Screw sidewalls of the upper drawer (11) to the base of drawers 2 and 3 (8) with confirmats (a). Screw the front wall of drawers 2 and 3 (7) to the previously assembled structure with confirmats (a). See Pic.1.

Assemble the middle and lower drawers in the same way, using for each their own side walls.

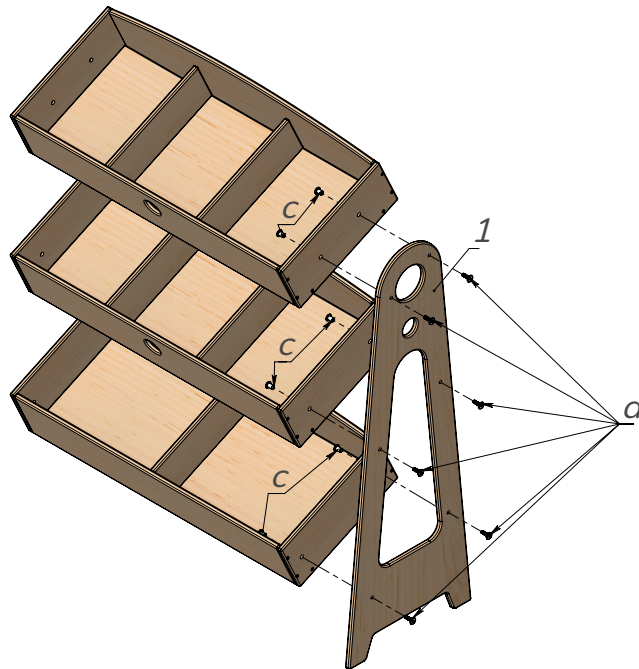

Pic. 2

Screw previously assembled drawers to the side panel (1) using screws (f) by holding it with the hex key (e). Fix the screw with the nut (c) from another side with the help of hex key (f). See Pic. 2.

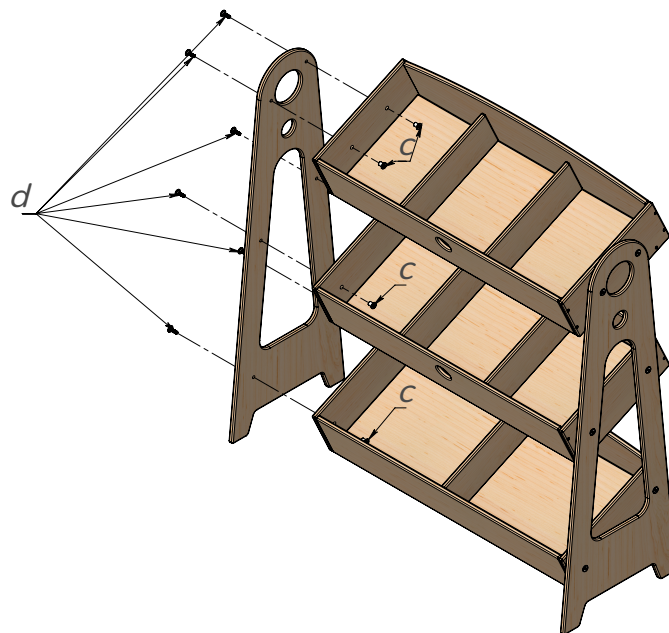

Pic. 3

Screw the second side panel (1) to the previously assembled structure using the screws (d) by holding them with hex key (e). Fix the screw with the nut (c) from another side by holding it with the hex key (f). See Pic. 3.



The products is meant for indoor use only.
To be used for its intended purpose only and under the direct supervision of an adult!
All the responsibility for children's injuries received during games on the furniture lies on adults watching after them.

Always be vigilant during children's games!