

TOWEL WARMER
INSTRUCTION MANUAL

Agua
CANADA

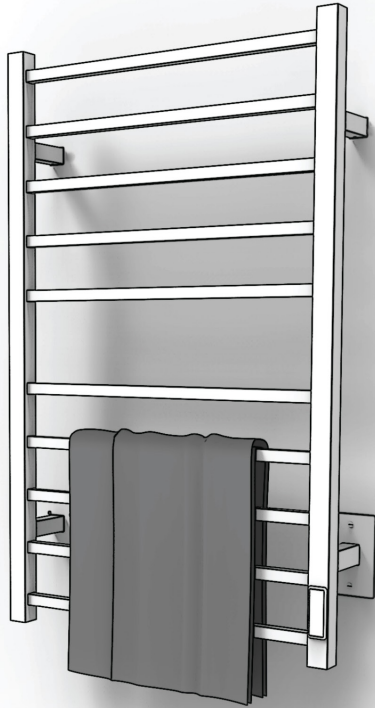

TOWEL WARMER INSTRUCTION MANUAL

Before using this product. Please read the following instructions carefully and keep this pamphlet for future reference.

ABOUT THE PRODUCT

This heated towel rail is designed for drying towels or clothes. It has a surface stabilized temperature of 40°C -50°C (104°F -122°F) and it used in household bathrooms and kitchens. This appliance is used under the voltage of 110V-120V AC and is manufactured according to ETL standard.

SAFETY PRECAUTIONS

1. The supplied power system which is connected to the towel rail must be used with a over-current protection device.
2. This product is supplied with the relevant, fitted three pin socket and three-wire cable, to avoid any risks or danger it must be properly grounded.
3. Any change of the repair to the damaged internal wires must be done by a qualified technician who is deemed qualified by the industry standard. When any external wire fittings are required, the power must be cut off completely.
4. Any hard scrubbing or scratching on the product surface is strictly prohibited.

NOTE

1. In the event of any technical statistics difference, please refer to the actual product.
2. Please wipe the towel rail with a soft dry clothes when cleaning it.

REQUIRED TOOLS

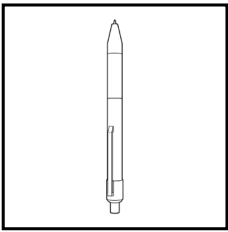

Pencil

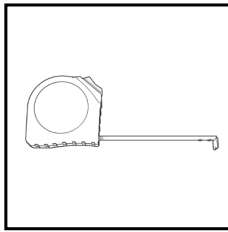

Tape Measure

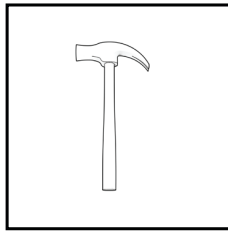

Hammer

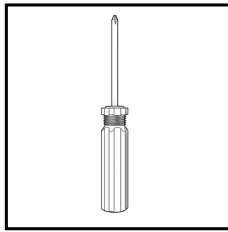

Cross screwdriver

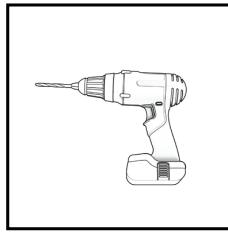

Electric Drill

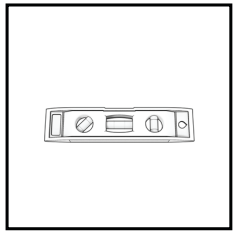

Leveling instrument

ACCESSORIES LIST

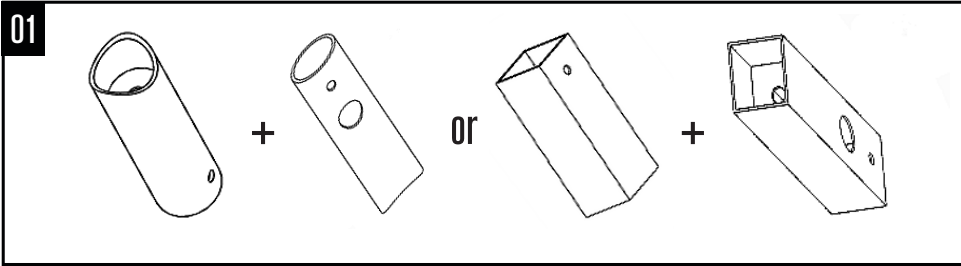

1pc
Power cord outlet wall bracket

3pcs
Normal wall bracket

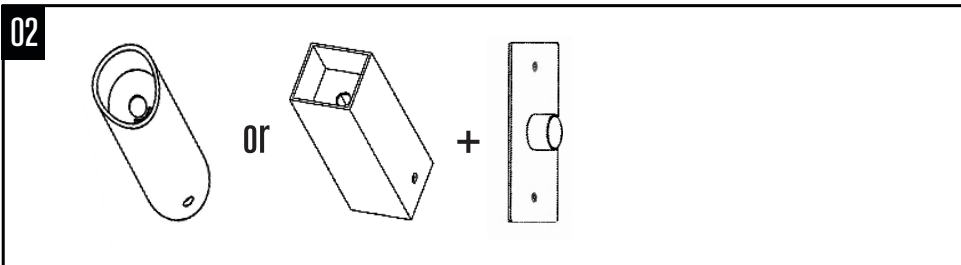

Hardwired wall bracket
+
Hardwired wall panel



4pcs
Long screw
M6 x 45mm

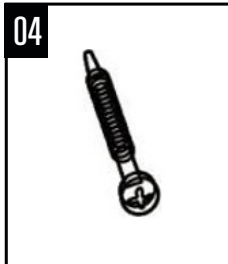

4pcs
Tapping
screw

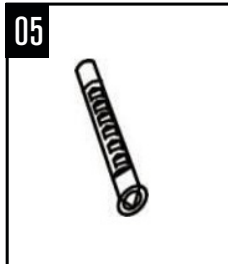

4pcs
Wall
anchor

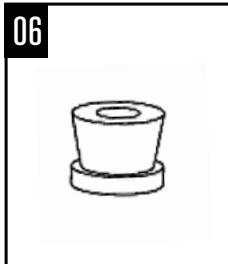

4pcs
Bushing



4pcs
M5 inner hex
angular set
screw



2pcs
Screw
M3.5 x 25mm

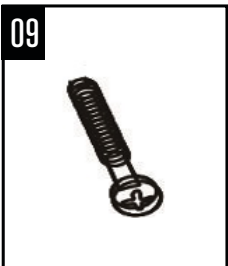

1 pc
Screw M6x10
(16)mm



1 pc
Screw
M5 x 8mm

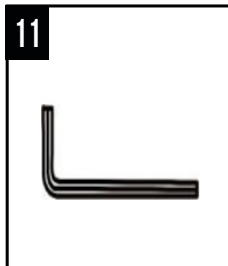

1 pc
Hex key
wrench

INSTALLATION STEPS

01

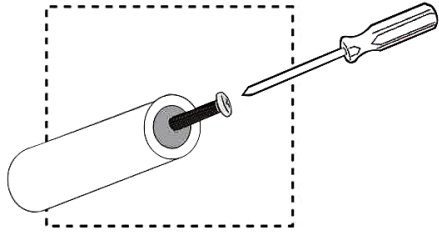

Drill the long screw (3) through the normal wall bracket (1)

02

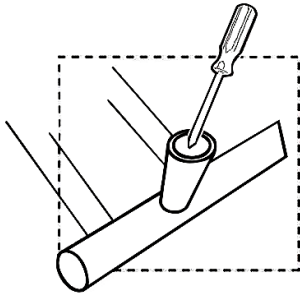

Screw down the long screw (3) to firmly connect the normal wall bracket (1) to the vertical bar. Note that the set screw on the wall bracket should be towards the floor when the unit is installed.

03

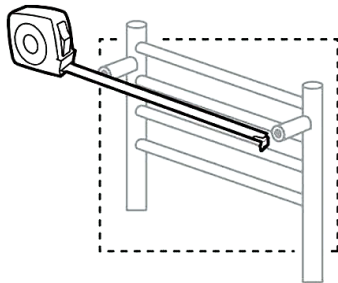

Use tape to measure the distance between these four holes, and the data AB, AC, CD and BD

04

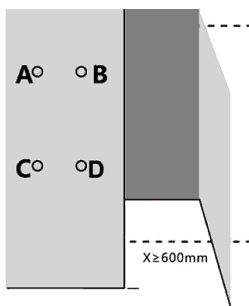

Mark A, B, C, D according to the distance. We strongly suggest it is installed at least 600mm above the floor level.

Try to install the towel warmer and use the leveling instrument to test the levelness and perpendicularity.

INSTALLATION STEPS

05

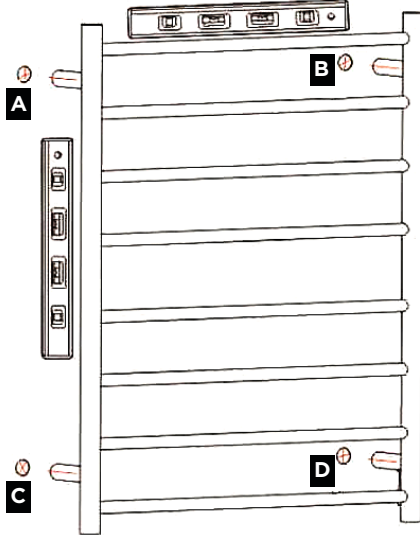

Drill A, B, C, D holes with size $\text{Ø}8 \times \text{D}45\text{mm}$. Use hammer to knock wall anchor (5) into the wall completely.

06

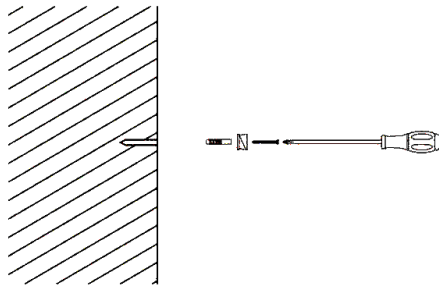

Insert the tapping screw (4) through bushing (6). Then into the wall anchor (5), make sure bushing (6) is firmly connected to the wall.

07

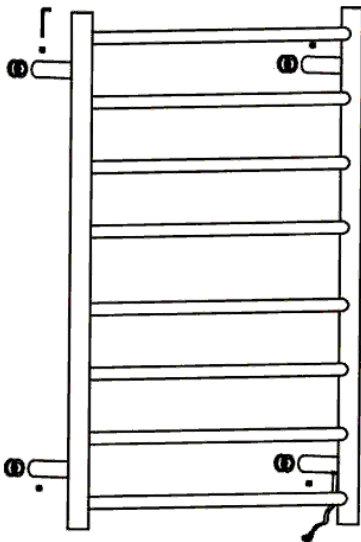

Connect the wall bracket (1) to the bushing (6), and tighten the set screw (7) by hex key wrench (11). Then plug in the unit and press the switch on.

INSTALLATION FOR HARDWIRED

01

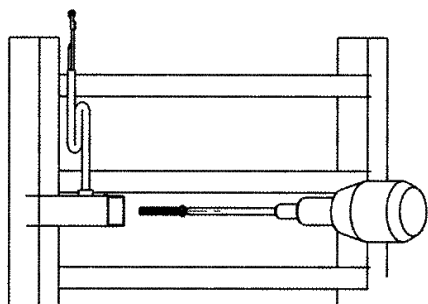

Cut off the plug.
Take out the wall bracket (1).

02

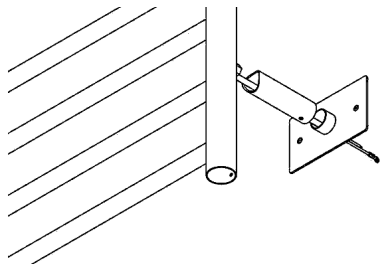

Connect hardwired wall bracket and panel (2) by screw (10). Screw down the screw (9) to firmly connect the hardwired wall bracket (2) to the vertical bar.

03

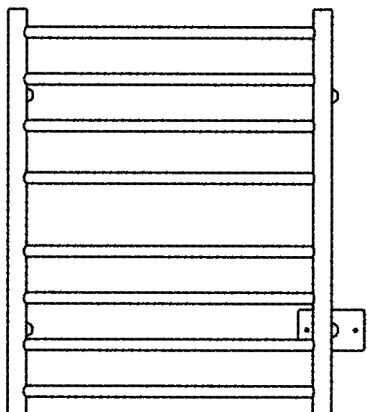

Fix the hardwired wall panel with screw (9).

WARNING

1. Only use for drying textiles which have been dampened by water.
2. The original wire cannot be replaced, when it is unworkable, the whole product should be replaced.
3. If the appliance is supplied from an extension cord set or electric portable outlet device, then the extension cord set or electric portable outlet device should be **positioned** so that it is **not subject to splashing or excessive moisture**.

AVAILABLE MODELS & DIMENSIONS

GEORGIA

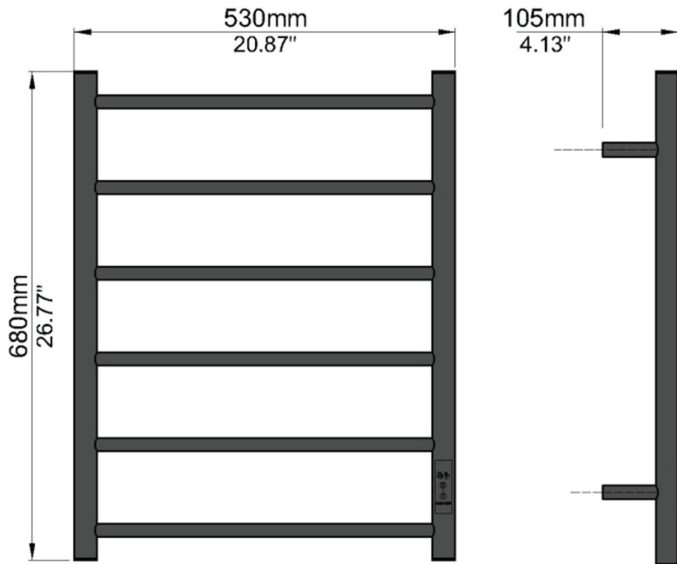

GUSTAVO

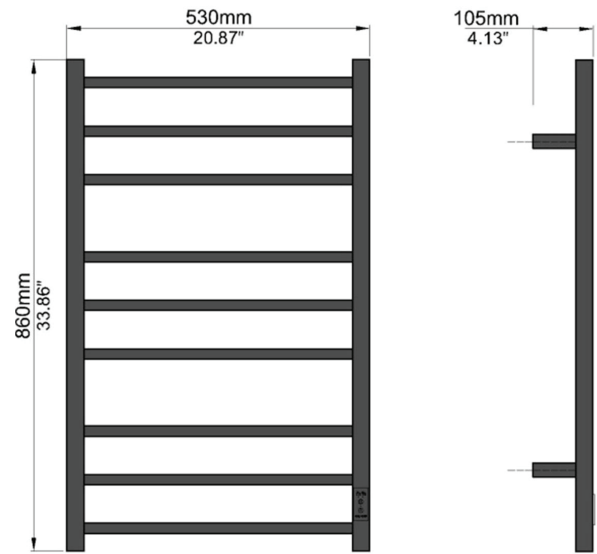

GIOVANNA

