

15' Stair Elevated Hunting Stand Assembly Manual



!!WARNING!! Safety is the most important aspect of enjoying this new hunting stand. Please read and comply with the steps laid out within these instructions. Failure to follow instructions may result in injury or death.



!!WARNING!! Safe use of this product is responsibility of the user. It is also the owners responsibility to provide these instructions to future owners should the product be borrowed or sold. Failure to follow these instructions may deem you personally liable in the court of law.



!!WARNING!! Initially and periodically inspect product for wear, corrosion, cracks or deterioration that may compromise the safe operation and use of the product. Immediately discontinue use if any type of defect is noticed and contact Orion Hunting Products at (906)-563-1230. Failure to follow instructions may result in injury or death.



!!WARNING!! Do not modify, leave out or misuse any or all parts of this product. If there is reason to believe parts to be missing or defective please contact Orion Hunting Products for replacement. Use only genuine Orion Hunting Product provided parts, attempting to use anything besides parts provided by manufacturer will void warranty. This product is not to be used outside the scope of its intended design and failure to follow instructions may result in injury or death.



!!WARNING!! Avoid underground utilities when anchoring. Always contact the local one-call system to prevent injury or death due to shock and electrocution, interruption of services, environmental accidents or job delays. Gas line rupture may cause explosion or fire. Contact with fiber optic cable may cause blindness due to exposure to laser light. National One-Call line is 1-888-258-0808

Any questions, comments or concerns please contact Orion Hunting Products at 906-767-0270

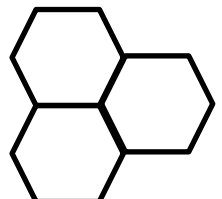

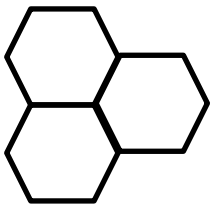

Thank you for purchasing a new Orion Hunting Products Elevated Metal Stand.

It is our Overwhelming desire to ensure that you are satisfied with this product.

We have taken great pride in every aspect of its design and manufacturing right here in the U.S.A. and it is our hope that you can take pride in owning it.

If it does not meet your expectations for any reason please give us a call or text at (906)-767-0270 and may it truly Elevate your Pursuit.

Be safe and Hunt Orion!

Tools Required

- 1) 9/16" Open End/Box End Combination Wrench
- 2) 9/16" Socket with Ratchet or Cordless Impact drill preferred
- 3) Large Hammer
- 4) Level
- 5) 8 Foot Ladder

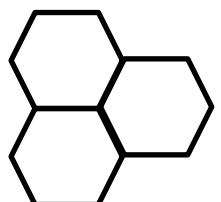
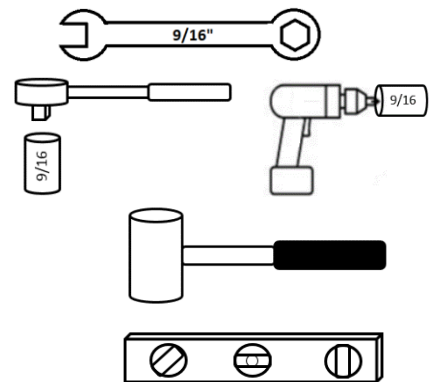

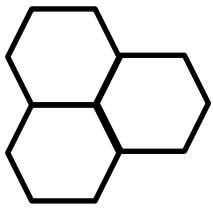

15' Stair Elevated Hunting Stand Overview

Please read through entire assembly instructions before beginning
Stand is rated for 1,000 pound capacity of blind and occupants combined.

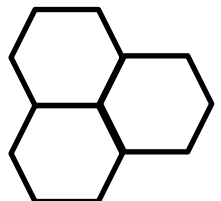
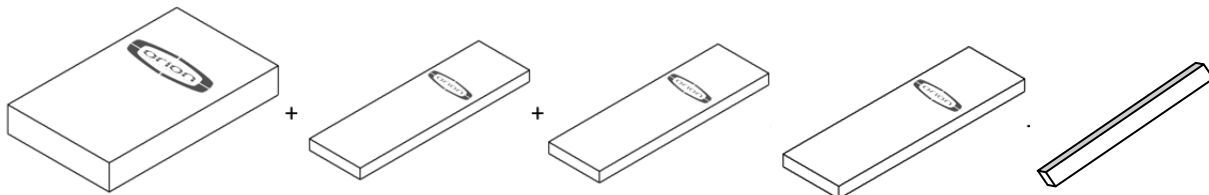
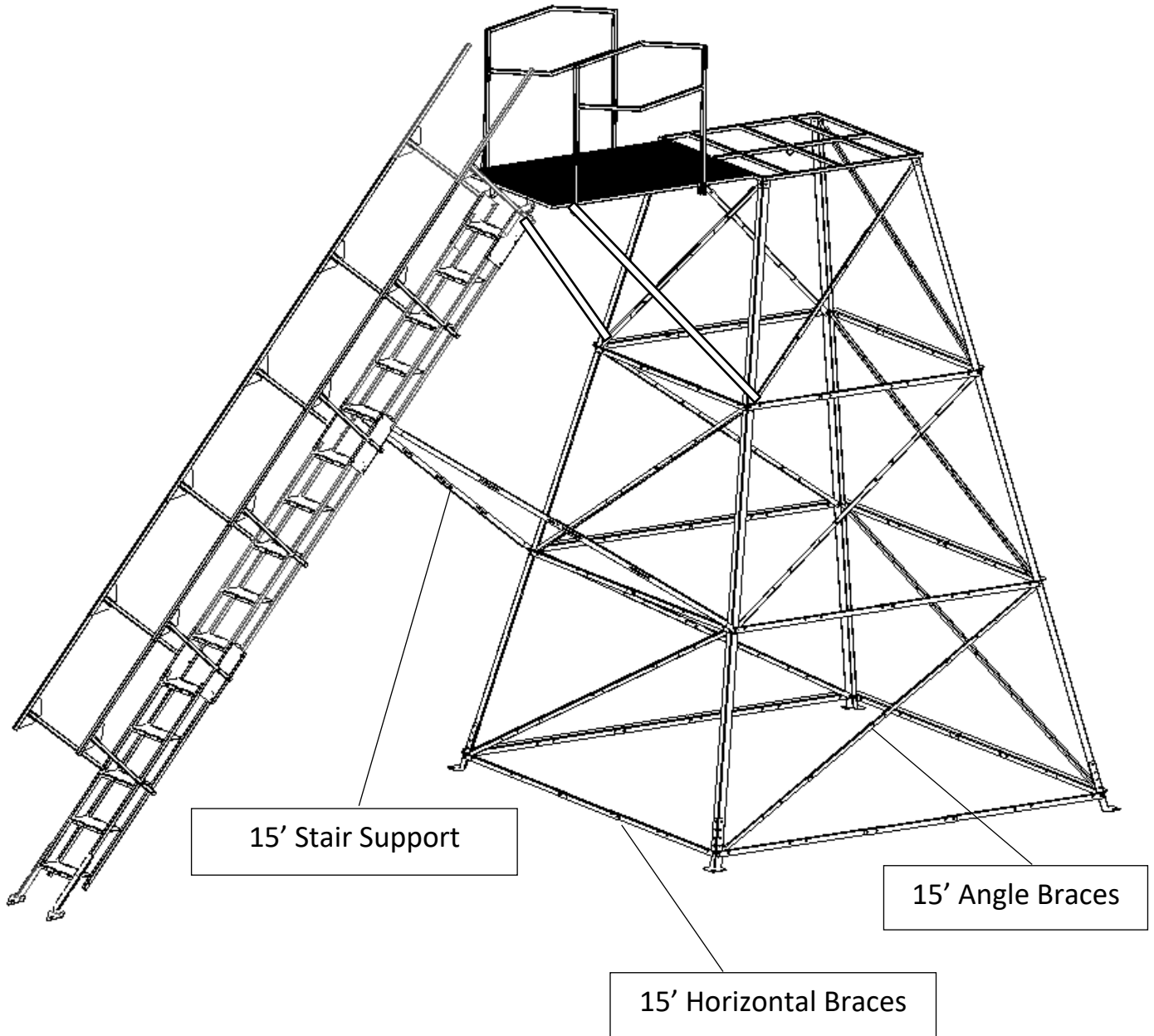

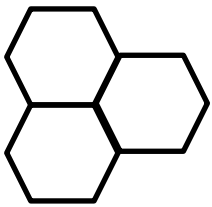

Elevated Hunting Stand Assembly

****Finger tighten hardware initially****
Attach Ground Anchor before use



1

Description:

Building Angle braces for bottom section of 15'

Parts:

2x Angles

1x Angle Connector

4x 1-1/2" Bolts and Nuts

Process:

Connect two Angles with Angle Connector. Do this 4 Times

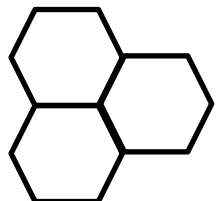
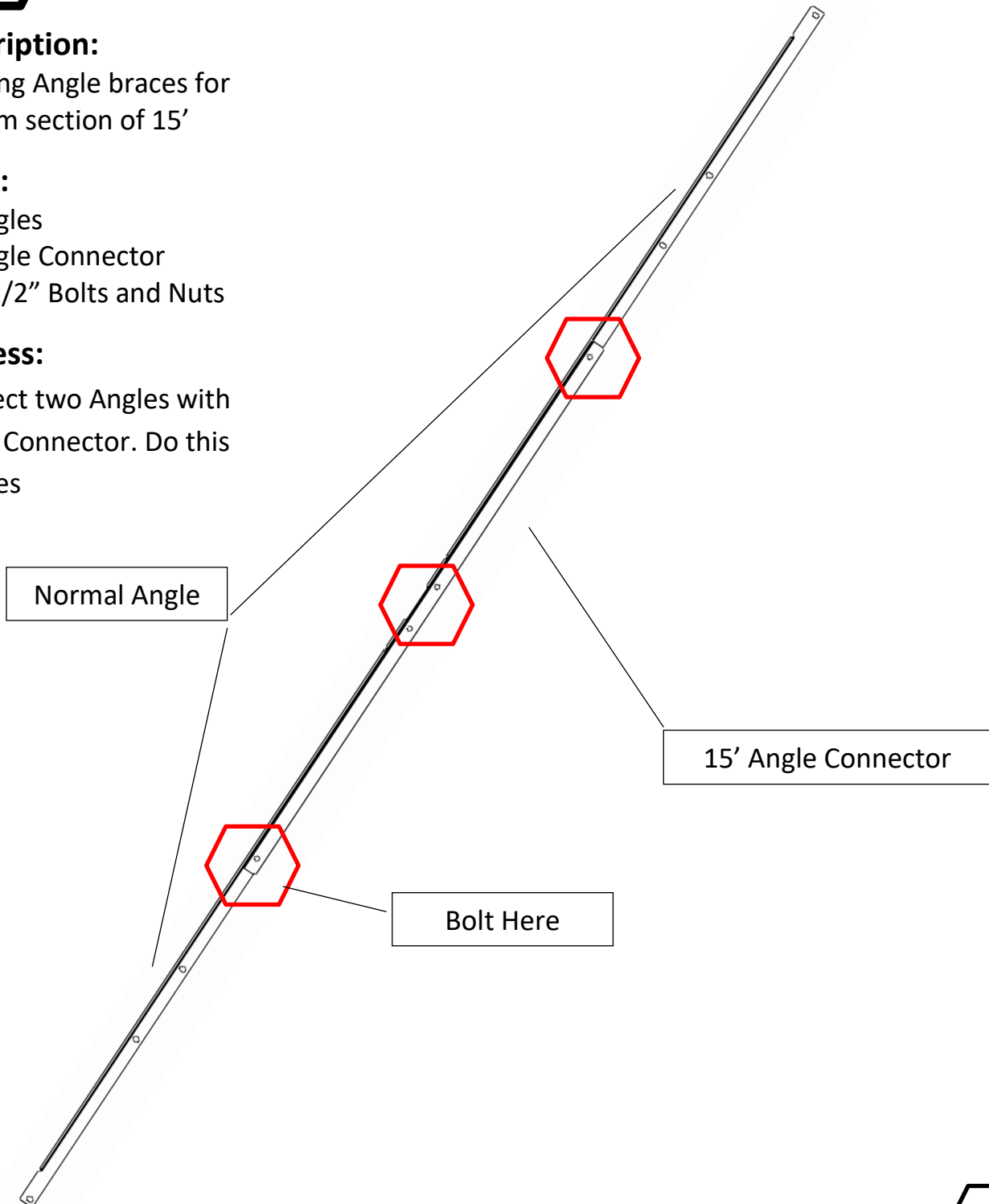

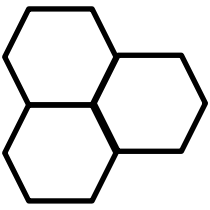

2

Description:

Building Horizontal braces for bottom section of 15'

Parts:

- 2x Horizontals
- 1x Horizontal Connector
- 4x 1-1/2" Bolts and Nuts

Process:

Connect two horizontals with Horizontal Connector. Do this 4 Times

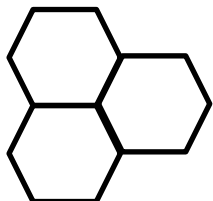
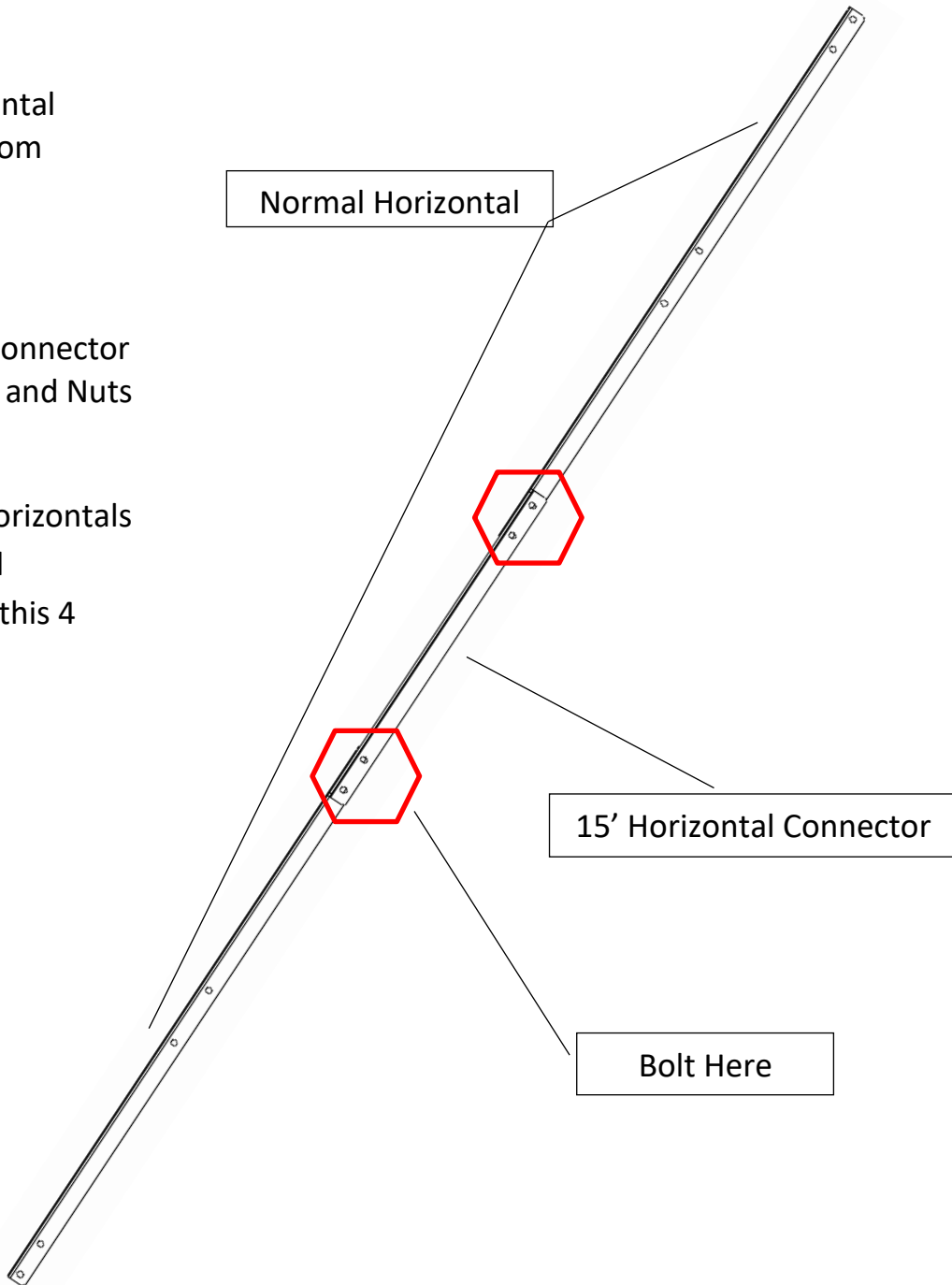

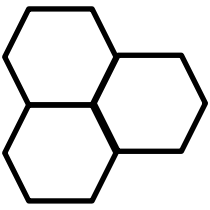

3

Description:

Building Stair Supports to connect from tower to stair

Parts:

- 2x Stair Supports
- 2x 1-1/2" Bolts & Nuts

Process:

Bolt Stair Supports together, finger tight. Final Adjustments will happen after stairs installed. Do this 2 times

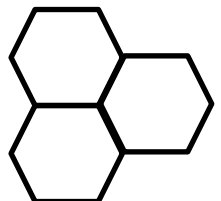
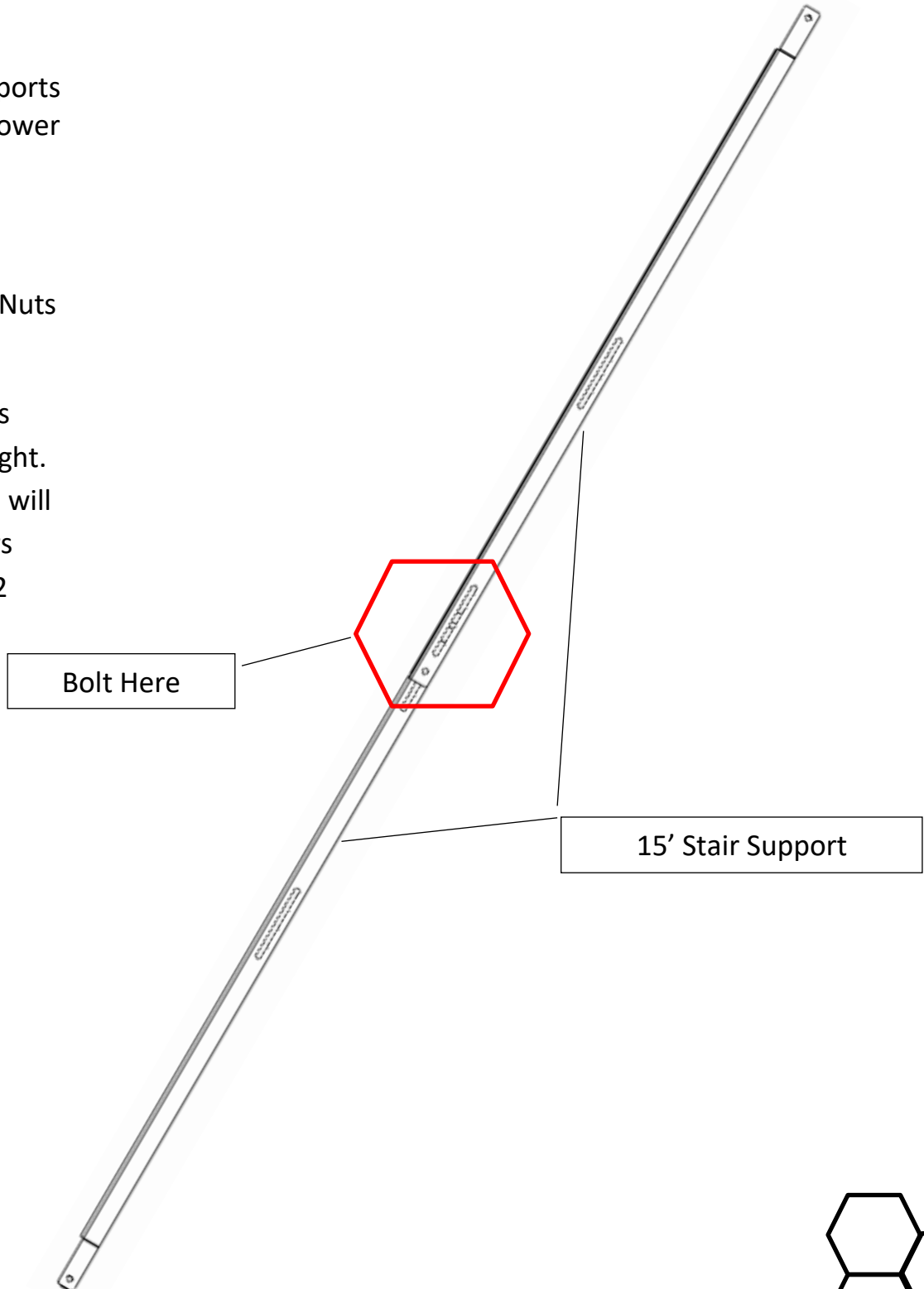

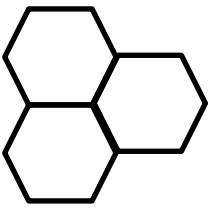

Stair Support Connection Detail

4

Reuse existing hardware

