

# MAGNA

Series 2000

MAGNA 32-60, 32-100

Installation and operating instructions



Conforms to ANSI/UL Std. 778  
Certified to CAN/CSA Std. E60335-2-51

Intertek  
4002198

## CONTENTS

	Page
1. <b>Limited warranty</b>	2
2. <b>Symbols used in this document</b>	3
3. <b>General description</b>	3
4. <b>Applications</b>	3
4.1 Pumped liquids	3
5. <b>Installation</b>	4
5.1 Positioning	4
5.2 Changing the control box position	5
5.3 Insulation shells	5
5.4 Non-return valve	5
5.5 Frost protection	5
6. <b>Electrical connection</b>	6
6.1 Supply voltage	6
6.2 Connection to the supply	6
7. <b>Start-up</b>	6
8. <b>Functions</b>	6
8.1 Functions selected via the pump control panel	6
8.2 Functions selected via the R100 remote control	6
8.3 Functions selected via expansion modules	7
8.4 Control modes	7
8.5 Selection of control mode	8
8.6 Automatic nighttime duty	8
8.7 Constant-curve duty	9
8.8 Max. or min. curve duty	9
8.9 Temperature influence	9
8.10 Expansion modules	10
8.11 Connection to LON network	10
9. <b>Pump setup</b>	10
9.1 Factory setting	10
9.2 Control panel	11
9.3 R100 remote control	12
9.4 R100 display overview	13
9.5 Menu OPERATION	14
9.6 Menu STATUS	14
9.7 Menu INSTALLATION	15
9.8 Priority of settings	16
10. <b>Troubleshooting</b>	17
10.1 Checking the module	18
11. <b>Megging</b>	19
12. <b>Technical data</b>	20
13. <b>Disposal</b>	20

## 1. Limited warranty

Products manufactured by GRUNDFOS PUMPS CORPORATION (Grundfos) are warranted to the original user only to be free of defects in material and workmanship for a period of 24 months from date of installation, but not more than 30 months from date of manufacture. Grundfos' liability under this warranty shall be limited to repairing or replacing at Grundfos' option, without charge, F.O.B. Grundfos' factory or authorized service station, any product of Grundfos' manufacture. Grundfos will not be liable for any costs of removal, installation, transportation, or any other charges which may arise in connection with a warranty claim. Products which are sold but not manufactured by Grundfos are subject to the warranty provided by the manufacturer of said products and not by Grundfos' warranty. Grundfos will not be liable for damage or wear to products caused by abnormal operating conditions, accident, abuse, misuse, unauthorized alteration or repair, or if the product was not installed in accordance with Grundfos' printed installation and operating instructions.

To obtain service under this warranty, the defective product must be returned to the distributor or dealer of Grundfos' products from which it was purchased together with proof of purchase and installation date, failure date, and supporting installation data. Unless otherwise provided, the distributor or dealer will contact Grundfos or an authorized service station for instructions. Any defective product to be returned to Grundfos or a service station must be sent freight prepaid; documentation supporting the warranty claim and/or a Return Material Authorization must be included if so instructed.

GRUNDFOS WILL NOT BE LIABLE FOR ANY INCIDENTAL OR CONSEQUENTIAL DAMAGES, LOSSES, OR EXPENSES ARISING FROM INSTALLATION, USE, OR ANY OTHER CAUSES. THERE ARE NO EXPRESS OR IMPLIED WARRANTIES, INCLUDING MERCHANTABILITY OR FITNESS FOR A PARTICULAR PURPOSE, WHICH EXTEND BEYOND THOSE WARRANTIES DESCRIBED OR REFERRED TO ABOVE.

Some jurisdictions do not allow the exclusion or limitation of incidental or consequential damages and some jurisdictions do not allow limit actions on how long implied warranties may last. Therefore, the above limitations or exclusions may not apply to you. This warranty gives you specific legal rights and you may also have other rights which vary from jurisdiction to jurisdiction.

## Warning

**Prior to installation, read these installation and operating instructions. Installation and operation must comply with local regulations and accepted codes of good practice.**



**This booklet should be left with the owner of the pump for future reference and information regarding its operation.**

## 2. Symbols used in this document



### Warning

*If these safety instructions are not observed, it may result in personal injury!*

Caution

*If these safety instructions are not observed, it may result in malfunction or damage to the equipment!*

Note

*Notes or instructions that make the job easier and ensure safe operation.*

## 3. General description

### Warning

*The use of this product requires experience with and knowledge of the product.*



*Persons with reduced physical, sensory or mental capabilities must not use this product, unless they are under supervision or have been instructed in the use of the product by a person responsible for their safety.*

*Children must not use or play with this product.*

The GRUNDFOS MAGNA Series 2000 is a circulator pump with integrated differential pressure control enabling adjustment of pump performance to the actual system requirements. In many systems, this will reduce the power consumption considerably, reduce noise from thermostatic valves and similar fittings, and improve the control of the system.

The desired head can be set on the pump control panel.



TM04 9389 4010

Fig. 1 Grundfos MAGNA Series 2000 circulator pump

## 4. Applications

The GRUNDFOS MAGNA is designed for circulating liquids in heating and air-conditioning systems.

The pump range is primarily used in

- systems with a **variable flow**.

The pump range can also be used in

- systems with a **constant flow** where it is desirable to optimize the setting of the pump duty point
- systems with **variable flow-pipe temperature**.

### 4.1 Pumped liquids

Grundfos MAGNA is intended for pumping clean water not containing solid particles or fibers.



### Warning

*The pump must not be used for the transfer of flammable liquids such as diesel oil, petrol or similar liquids.*

## 5. Installation

Arrows on the pump housing indicate the liquid flow direction through the pump.

### 5.1 Positioning

GRUNDFOS MAGNA must be installed with the pump head in horizontal position; see fig. 2.

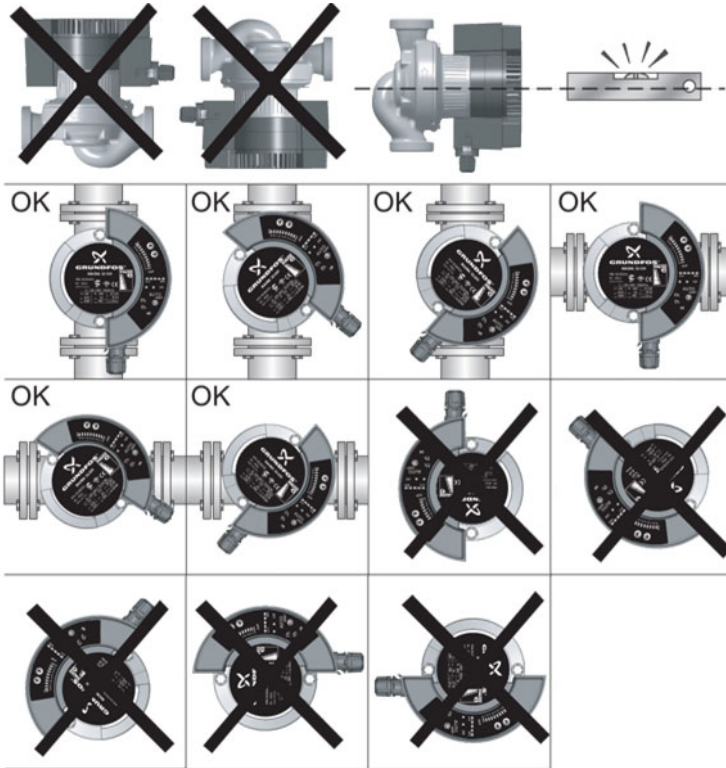

Fig. 2 Installation positions



## 5.2 Changing the control box position

### Warning

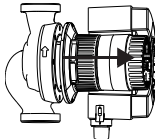
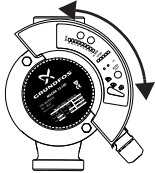
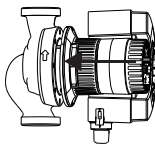

**Before any dismantling of the pump, the system must be drained or the isolating valves on both sides of the pump must be closed as the pumped liquid may be scalding hot and under high pressure.**

Procedure:

Step	Action	Illustration
1	Remove the two screws.	 TM03 0474 5204
2	Pull the stator and the pump head approx. 0.22 inches (5 mm) out.	 TM03 0475 5204
3	Turn the stator and the pump head to the desired position.	 TM03 0476 5204
4	Push the stator and the pump head into place.	 TM03 0475 5204
5	Refit the two screws (16 + 5 Nm).	 TM03 0580 0305

### 5.2.1 Control box position

For permissible control box positions, see the Quick Guide.

## 5.3 Insulation shells

**Note** *It is recommended to fit insulation shells to the pump.*

Insulation shells for pumps in heating systems are supplied with the pump.

For cold water applications, a silicone RTV sealant must be liberally applied to the area shown in fig. 3 to prevent condensation between the shell and pump housing. Follow the sealant manufacturers instructions for safety and proper usage.

The fitting of insulation shells will increase the pump dimensions.

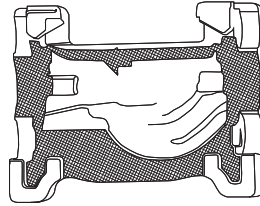

TM04 9313 3910

**Fig. 3** Shaded area indicates silicone RTV sealant

## 5.4 Non-return valve

If a non-return valve is fitted in the pipe system, see fig. 4; ensure that the set minimum discharge pressure of the pump is always higher than the closing pressure of the valve. This is especially important in proportional-pressure control mode (reduced head at low flow).

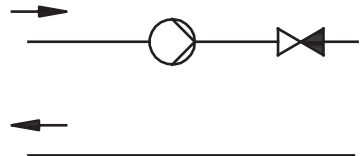

TM02 0640 0301

**Fig. 4** Non-return valve

## 5.5 Frost protection

If the pump is not used during periods of frost, necessary steps must be taken to prevent bursting pipes.

**Note** *Additives with a density and/or kinematic viscosity higher than those/that of water will reduce the hydraulic performance.*

## 6. Electrical connection

The electrical connection and protection must be carried out in accordance with local regulations.

### Warning

**Risk of electric shock —**  
*This pump is supplied with a grounding conductor and grounding-type attachment plug. To reduce the risk of electric shock, be certain that it is connected only to a properly grounded, grounding-type receptacle.*

### Warning



*The pump must be connected to an external disconnect switch. Grounding can be used for protection against indirect contact. Megging must be carried out as described in section 11. Megging.*

### Warning

*If the pump is connected to an electric installation where a Ground Fault Circuit Interrupt (GFCI) is used as additional protection, this circuit breaker must trip out when ground fault currents with DC content (pulsating DC) occur.*

- The pump requires no external motor protection.
- Check that the supply voltage and frequency correspond to the values stated on the pump nameplate.

### 6.1 Supply voltage

1 x 208 - 230 V +/- 10 %, 50/60 Hz.

### 6.2 Connection to the supply

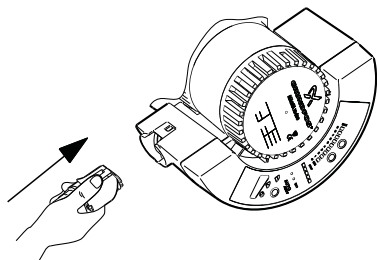

TM03 0520 0105

## 7. Start-up

Do not start the pump until the system has been filled with liquid and vented. Furthermore, the required minimum inlet pressure must be available at the pump inlet, see section 12. *Technical data.* The system cannot be vented through the pump.

## 8. Functions

Most functions can be selected via the pump control panel. However, some functions can only be selected with the R100 or via expansion modules.

### 8.1 Functions selected via the pump control panel

The following functions are selected via the pump control panel; see fig. 11.

- **AUTOADAPT** (factory setting)  
 Recommended for most heating installations. During operation, the pump automatically makes the necessary adjustment to the actual system characteristic. This setting ensures minimum energy consumption and noise level which reduces operating costs and increases comfort.
- **Proportional-pressure control**  
 The pump head is changed continuously in accordance with the water demand in the system. The desired setpoint can be set on the pump control panel.
- **Constant-pressure control**  
 A constant head is maintained, regardless of water demand. The desired setpoint can be set on the pump control panel.

### Automatic night-time duty

The pump changes automatically between normal duty and night-time duty depending on the flow-pipe temperature. Automatic nighttime duty can be combined with the above-mentioned control modes.

### 8.2 Functions selected via the R100 remote control

Additional functions can be selected via the R100 remote control:

- **Constant-curve duty**  
 The pump runs at a constant speed, on or between the max. and min. curves.
- **Temperature influence**  
 The pump head varies depending on the liquid temperature.

### 8.3 Functions selected via expansion modules

Further functions are available via the GENI module or the relay module:

#### 8.3.1 GENI module

- **External analog control** of head or speed via a signal from an external 0-10 V signal transmitter.
- **External forced control** via inputs for:
  - Max. curve
  - Min. curve
- **Bus communication via GENIBus**  
The pump can be controlled and monitored by a Grundfos Control MPC Series 2000, a building management system or another type of external control system.
- **External start/stop**  
The pump can be started and stopped via the = digital input.
- **Fault, ready and operating indication via signal relay**  
The pump controls an external fault, ready and operating signal relay via a potential-free output. The function of the signal relay is set with the R100.

#### 8.3.2 Relay module

- **External start/stop**  
The pump can be started and stopped via the digital input.
- **Fault, ready and operating indication via signal relay**  
The pump controls an external fault, ready and operating signal relay via a potential-free output. The function of the signal relay is set with the R100.

### 8.4 Control modes

A GRUNDFOS MAGNA pump can be set to the control mode which is most suitable for the individual system.

Possible control modes:

- AUTO<sub>ADAPT</sub> (factory setting)
- Proportional pressure
- Constant pressure.

Each of the control modes can be combined with automatic night-time duty, see section 8.6 *Automatic nighttime duty*.

#### AUTO<sub>ADAPT</sub>

To be set on the control panel or with the R100, see section 9. *Pump setup*.

The control mode AUTO<sub>ADAPT</sub> continuously adapts the pump performance.

The setpoint of the pump has been factory-set as follows and cannot be changed manually:

- MAGNA 32-60 to 12 ft (3.6 m)
- MAGNA 32-100 to 18 ft (5.5 m).

When the pump registers a lower pressure on the max. curve, A<sub>2</sub>, the AUTO<sub>ADAPT</sub> function automatically selects a correspondingly lower control curve, H<sub>set2</sub>, thus reducing the energy consumption.

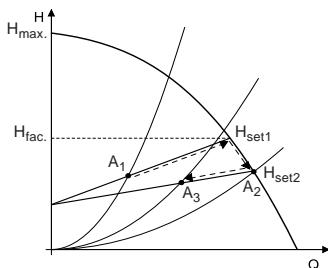



Fig. 5 AUTO<sub>ADAPT</sub>

- A<sub>1</sub>: Original duty point.
- A<sub>2</sub>: Lower registered pressure on the max. curve.
- A<sub>3</sub>: New duty point after AUTO<sub>ADAPT</sub> control.
- H<sub>set1</sub>: Original setpoint.
- H<sub>set2</sub>: New setpoint after AUTO<sub>ADAPT</sub> control.
- H<sub>fac.</sub>: Factory-set setpoint.

The AUTO<sub>ADAPT</sub> function can be reset by pressing the button  for approx. 10 seconds until the control mode is back to the starting point (AUTO<sub>ADAPT</sub> or AUTO<sub>ADAPT</sub> with automatic nighttime duty).

#### Proportional-pressure control

To be set on the control panel or with the R100, see section 9. *Pump setup*.

The pump head is reduced at decreasing water demand and increased at rising water demand; see fig. 6.

#### Constant-pressure control

To be set on the control panel or with the R100, see section 9. *Pump setup*.

The pump maintains a constant pressure, regardless of water demand; see fig. 6.

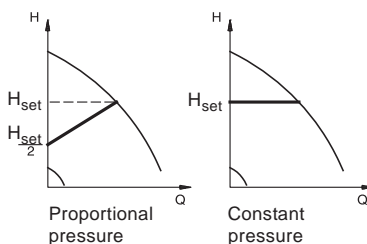





Fig. 6 Pressure control

## 8.5 Selection of control mode

System type	Description	Select this control mode
Typical heating systems	Grundfos recommends to let the pump remain in AUTO <sub>ADAPT</sub> mode. This ensures optimum performance at the lowest possible energy consumption.	AUTO <sub>ADAPT</sub>
Relatively great head losses in the distribution pipes and air-conditioning systems	<ol style="list-style-type: none"> <li>Two-pipe heating systems with thermostatic valves and: <ul style="list-style-type: none"> <li>with a pump head higher than 10 ft (3 m),</li> <li>very long distribution pipes,</li> <li>strongly throttled pipe balancing valves,</li> <li>differential pressure regulators,</li> <li>great head losses in those parts of the system through which the total quantity of water flows (e.g. boiler, heat exchanger and distribution pipe up to the first branching).</li> </ul> </li> <li>Primary circuit pumps in systems with great head losses in the primary circuit.</li> <li>Air-conditioning systems with <ul style="list-style-type: none"> <li>heat exchangers (fan coils),</li> <li>cooling ceilings,</li> <li>cooling surfaces.</li> </ul> </li> </ol>	Proportional pressure 
Relatively small head losses in the distribution pipes	<ol style="list-style-type: none"> <li>Two-pipe heating systems with thermostatic valves and: <ul style="list-style-type: none"> <li>with a pump head lower than 6.5 ft (2 m),</li> <li>with small head losses in those parts of the system through which the total quantity of water flows (e.g. boiler, heat exchanger and distribution pipe up to the first branching) or</li> <li>modified to a high differential temperature between flow pipe and return pipe (e.g. district heating).</li> </ul> </li> <li>Underfloor heating systems with thermostatic valves.</li> <li>One-pipe heating systems with thermostatic valves or pipe balancing valves.</li> <li>Primary circuit pumps in systems with small head losses in the primary circuit.</li> </ol>	Constant pressure 

### 8.5.1 Setpoint setting

The setpoint can be set by pressing  or  when the pump is in control mode:

- proportional pressure,
- constant pressure or
- constant-curve duty.

Set the setpoint so that it matches the system.

A too high setting may result in noise in the system whereas a too low setting may result in insufficient heating or cooling in the system.

If AUTO<sub>ADAPT</sub> is selected, the setpoint cannot be set.

### 8.6 Automatic nighttime duty

To be set on the control panel or with the R100, see section 9. *Pump setup*.

Once automatic nighttime duty has been activated, the pump automatically changes between normal duty and night-time duty (duty at low performance).

Changeover between normal duty and nighttime duty is dependent on the flow-pipe temperature.

The pump automatically changes over to nighttime duty when the built-in sensor registers a flow-pipe temperature drop of more than 18 °F - 27 °F (10 °C - 15 °C) within approx. 2 hours. The temperature drop must be at least 0.18 °F/min (0.1 °C/min).

Changeover to normal duty takes place without a time lag when the temperature has increased by approx. 18 °F (10 °C).

Note

**Automatic nighttime duty cannot be used in air-conditioning systems.**



### 8.7 Constant-curve duty

To be set with the R100, see section 9. *Pump setup*. The pump can be set to operate according to a constant curve, like an uncontrolled pump, see fig. 8. When the pump has been set to constant-curve mode with the R100, the setting can be changed on the control panel or with the R100.

#### MAGNA 32-60, 32-100

Select one of 9 curves (81 curves with the R100) between the max. and min. curves, see fig. 7.

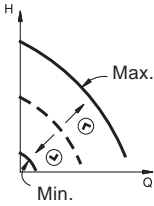

Fig. 7 Operating curves

TM03 0551 0205

### 8.8 Max. or min. curve duty

To be set on the control panel, with the R100 or via GENI module, see section 9. *Pump setup*.

The pump can be set to operate according to the max. or min. curve, like an uncontrolled pump, see fig. 8.

This operating mode is available, regardless of the control mode.

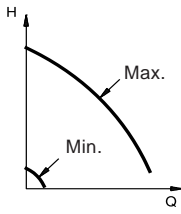

Fig. 8 Max. and min. curves

TM00 5547 4596

The **max. curve** mode can be selected if an uncontrolled pump is required.

The **min. curve** mode can be used in periods in which a minimum flow is required. This operating mode is for instance suitable for manual nighttime duty if automatic night-time duty is not desired.

### 8.9 Temperature influence

To be set with the R100, see section 9. *Pump setup*. When this function is activated in proportional- or constant-pressure control mode, the setpoint for head will be reduced according to the liquid temperature.

It is possible to set temperature influence to function at liquid temperatures below 176 °F (80 °C) or below 122 °F (50 °C). These temperature limits are called  $T_{max}$ . The setpoint is reduced in relation to the head set (= 100 %) according to the characteristics below.

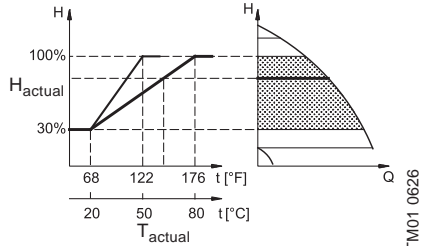

Fig. 9 Temperature influence

TM01 0626

In the above example,  $T_{max} = 176$  °F (80 °C) has been selected. The actual liquid temperature  $T_{actual}$  causes the setpoint for head to be reduced from 100 % to  $H_{actual}$ .

The temperature influence function requires:

- Proportional- or constant-pressure control mode.
- The pump must be installed in the flow pipe.
- System with flow-pipe temperature control.

Temperature influence is suitable in:

- systems with variable flows (e.g. two-pipe heating systems), in which the activation of the temperature influence function will ensure a further reduction of the pump performance in periods with small heating demands and consequently a reduced flow-pipe temperature.
- systems with almost constant flows (e.g. one-pipe heating systems and underfloor heating systems), in which variable heating demands cannot be registered as changes in the head as is the case with two-pipe heating systems. In such systems, the pump performance can only be adjusted by activating the temperature influence function.

#### Selection of $T_{max}$ .

In systems with a flow-pipe temperature of:

- up to and including 131 °F (55 °C), select  $T_{max} = 122$  °F (50 °C),
- above 131 °F (55 °C), select  $T_{max} = 176$  °F (80 °C).

**Note** The temperature influence function cannot be used in air-conditioning systems.

## 8.10 Expansion modules

The pump can be fitted with an expansion module enabling communication with external signals (signal transmitters).

Two types of expansion modules are available:

- Relay module
- GENI module.

### 8.10.1 Relay module

For mounting and operation, see relay module installation and operating instructions.

#### Functions

- External start/stop
- Fault, ready and operating indication via signal relay.

### 8.10.2 GENI module

For mounting and operation, see GENI module installation and operating instructions.

#### Functions

- External start/stop
- External forced control
- External analog 0-10 V control
- Bus communication via GENIbus
- Duty standby alternating mode
- Fault, ready and operating indication via signal relay.

## 8.11 Connection to LON network

The pump can be connected to a LON network via a GENI module and an external Grundfos G10 LON interface. Product number: 605726.

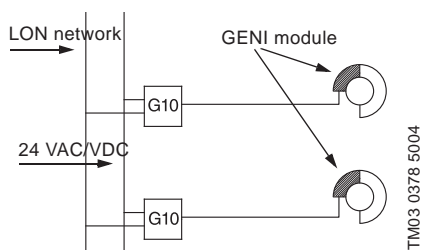

Fig. 10 Connection to LON network

## 9. Pump setup

For the setting of the pump, use:

- control panel.
- R100 remote control.
- bus communication (not described in detail in these instructions, contact Grundfos).

The table shows the application of the individual operating units and in which section the function has been described.

Possible settings	Control panel	R100
AUTO <sub>ADAPT</sub>	9.2.1	9.7.1
Automatic nighttime duty	9.2.1	9.7.2
Proportional-pressure control	9.2.1	9.7.1
Constant-pressure control	9.2.1	9.7.1
Setpoint setting	9.2.2	9.5.1
Max. curve duty	9.2.3	9.5.2
Min. curve duty	9.2.4	9.5.2
Constant-curve duty	–	9.5.2
Temperature influence	–	9.7.3
Activation/deactivation of pump buttons	–	9.7.4
Allocation of pump number	–	9.7.6
Start/stop	9.2.5	9.5.2
Resetting of fault indications	9.2.6	9.5.3
Reading of various data	–	9.6.1 - 9.6.7

"–" = not available with this operating unit.

### 9.1 Factory setting

The pump is factory-set to AUTO<sub>ADAPT</sub> without automatic nighttime duty.

## 9.2 Control panel

### Warning



At high liquid temperatures, the pump may be so hot that only the buttons should be touched to avoid burns.

The control panel, fig. 11, incorporates:

Pos.	Description
1	Buttons for setting
2	<ul style="list-style-type: none"> <li>Indicator lights for operating and fault indication and</li> <li>symbol for indication of external control</li> </ul>
3	Button for change of control mode
4	Light symbols for indication of control mode and night-time duty
5	Light fields for indication of head, flow and operating mode

For further information, see section 10. Troubleshooting.

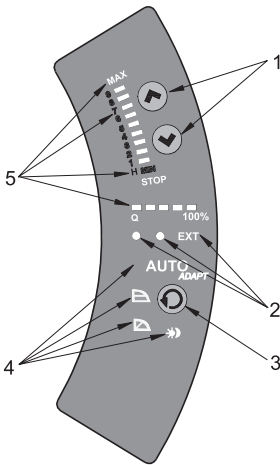



Fig. 11 Control panel

TM03 8752 2407

### 9.2.1 Control mode setting

Description of function, see section 8.4 Control modes.

To change the control mode, press , pos. 3, according to this cycle:

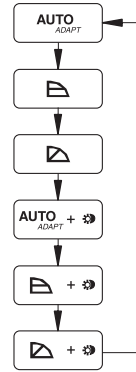









Fig. 12 Cycle of control modes

Automatic nighttime duty can be activated together with each of the control modes.

The light symbols in pos. 4 of fig. 11, indicate the pump settings:

Light in	Control mode	Automatic nighttime duty
AUTO <sub>ADAPT</sub>	AUTO <sub>ADAPT</sub>	NO
	Proportional pressure	NO
	Constant pressure	NO
-	Constant curve	NO
AUTO <sub>ADAPT</sub> 	AUTO <sub>ADAPT</sub>	YES
 	Proportional pressure	YES
 	Constant pressure	YES
- 	Constant curve	YES

"-" = no light.

TM03 1288 1505

### 9.2.2 Setpoint setting

Set the setpoint of the pump by pressing  $\odot$  or  $\ominus$  when the pump has been set to proportional-pressure control, constant-pressure control or constant-curve duty.

The light fields, pos. 5, on the control panel indicate the setpoint set.

#### MAGNA 32-60, 32-100

The light fields can indicate a maximum setpoint of 29.5 ft (9 m).

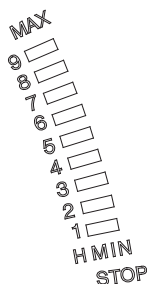

Fig. 13 Light fields MAGNA xx-100

### 9.2.3 Setting to max. curve duty

Description of function, see section 8.8 *Max. or min. curve duty*.

To change over to the max. curve, press  $\odot$  continuously until "MAX" illuminates, see fig. 14. To change back, press  $\ominus$  continuously until the desired setpoint is indicated.

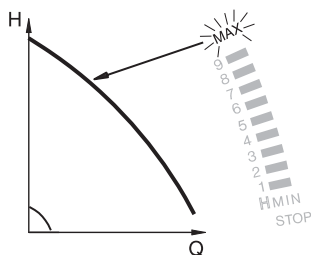

Fig. 14 Max. curve

### 9.2.4 Setting to min. curve duty

Description of function, see section 8.8 *Max. or min. curve duty*.

To change over to the min. curve, press  $\ominus$  continuously until "MIN" illuminates, see fig. 15. To change back, press  $\odot$  continuously until the desired setpoint is indicated.

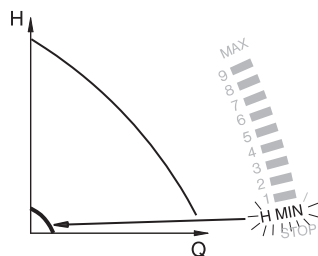

Fig. 15 Min. curve

### 9.2.5 Start/stop of pump

To stop the pump, press  $\ominus$  continuously until "STOP" illuminates. When the pump is stopped, the green indicator light will be flashing.

To start the pump, press  $\odot$  continuously.

***If the pump is to be stopped, it is recommended to use the start/stop input, the R100 or to switch off the electricity supply. In this way, the setpoint will remain unchanged when the pump is started again.***

Note

### 9.2.6 Resetting of fault indications

The fault indications are reset by briefly pressing any button. The settings remain unchanged. If the fault has not disappeared, the fault indication will reappear within 4.5 minutes.

### 9.3 R100 remote control

The pump is designed for wireless communication with the Grundfos R100 remote control. The R100 communicates with the pump via infrared light.

During communication, the R100 must be pointed at the pump control panel. When the R100 is communicating with the pump, the red indicator light will flash rapidly.

The R100 offers additional possibilities of setting and status displays for the pump.

TM03 0380 2507

TM03 0381 2507

TM03 0382 2507

## 9.4 R100 display overview

The R100 displays are divided into four parallel menus, see fig. 16:

0. GENERAL, see operating instructions for R100

1. OPERATION

2. STATUS

3. INSTALLATION

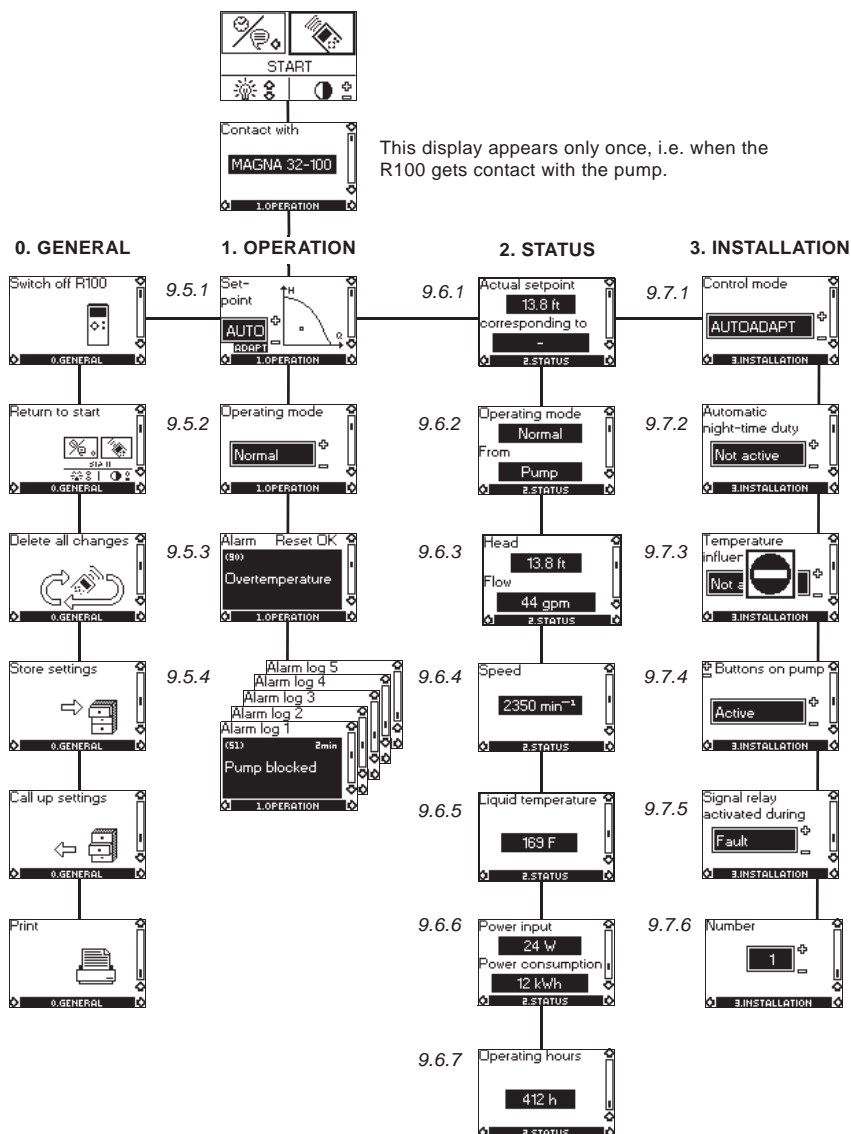

Fig. 16 Menu overview

## 9.5 Menu OPERATION

When the communication between the R100 and the pump has been established, "Contact with" appears in the display. When the "arrow down" on the R100 is pressed, menu OPERATION appears.

**Note**

*The display "Contact with" appears only once, i.e. when the R100 gets contact with the pump.*

### 9.5.1 Setpoint

This display depends on the control mode selected in the display "Control mode" in menu INSTALLATION.

If the pump is forced-controlled via external signals, the number of possible settings will be reduced, see section 9.8 *Priority of settings*. Attempts to change the settings will result in an indication in the display saying that the pump is forced-controlled and changes therefore cannot be made.

This display will appear when the pump is in AUTO<sub>ADAPT</sub> mode.

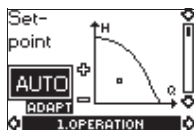

Set the desired setpoint by pressing the buttons "+" and "-" on the R100 (not possible when the pump is in AUTO<sub>ADAPT</sub> mode).

Furthermore, it is possible to select one of these operating modes:

- Stop
- Min. (min. curve)
- Max. (max. curve).

The display is different if proportional pressure, constant pressure or constant curve has been selected.

The actual duty point of the pump is indicated by a square in the Q/H field. No indication at low flow.

### 9.5.2 Operating mode

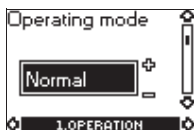

Select an operating mode:

- Stop
- Min. (min. curve)
- Normal (AUTO<sub>ADAPT</sub>, proportional pressure, constant pressure or constant curve)
- Max. (max. curve).

### 9.5.3 Fault indications



If the pump is in alarm status, the cause will appear in this display.

Possible causes:

- Pump blocked
- Internal fault
- Overvoltage
- Undervoltage
- Overtemperature
- Module fault
- Fault in module communication.

The fault indication can be reset in this display.

If the fault has not disappeared when resetting is attempted, the fault indication will reappear in the display when communicating with the pump.

### 9.5.4 Alarm log

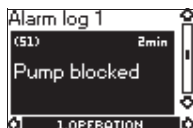

The alarm code with text appears in this display. The display also shows the number of minutes the pump has been connected to the electricity supply after the fault occurred.

The last five fault indications will appear in the alarm log.

## 9.6 Menu STATUS

The displays appearing in this menu are status displays only. It is not possible to change or set values.

The actual values in the display are indicative and based on estimation.

### 9.6.1 Actual setpoint

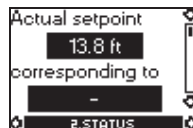

**Field "Actual setpoint":**

Actual setpoint of pump.

**Field "corresponding to":**

Actual setpoint in % of the setpoint set if the pump is connected to an external analog 0-10 V signal transmitter or if temperature influence or proportional-pressure control is activated.

### 9.6.2 Operating mode

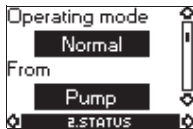

This display shows the actual operating mode (*Stop, Min., Normal or Max.*) and where it was selected (*Pump, R100, BUS or External*).

### 9.6.3 Head and flow

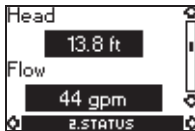

The actual head and flow of the pump.

If "<" is indicated in front of the flow, the flow is less than the displayed value.

If the pump is unable to determine head and flow, this is indicated by "-".

### 9.6.4 Speed



The actual pump speed.

### 9.6.5 Liquid temperature

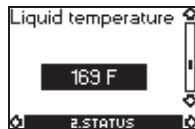

The actual temperature of the pumped liquid.

### 9.6.6 Power input and power consumption

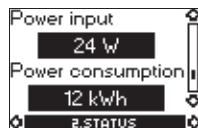

Actual power input and power consumption of the pump.

The value of power consumption is an accumulated value and cannot be set to zero.

### 9.6.7 Operating hours



Operating hours of the pump.

The value of operating hours is an accumulated value and cannot be set to zero.

## 9.7 Menu INSTALLATION

This menu shows the settings that should be considered when installing the pump.

### 9.7.1 Control mode

Description of function, see section 8.4 *Control modes* or 8.7 *Constant-curve duty*.



Select one of the control modes:

- *AUTO<sub>ADAPT</sub>*
- *Prop. pressure* (proportional pressure)
- *Const. pressure* (constant pressure)
- *Const. curve* (constant curve).

Setting of setpoint and curve is carried out in display 9.5.1 *Setpoint* in menu OPERATION (not possible when the pump is in *AUTO<sub>ADAPT</sub>* mode).

### 9.7.2 Automatic night-time duty



In this display, automatic night-time duty can be activated or deactivated.

Automatic night-time duty can be set to:

- *Active*
  - *Not active*,
- irrespective of the control mode selected.

### 9.7.3 Temperature influence

Description of function, see section 8.9 *Temperature influence*.

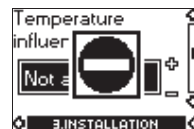

Note

If the pump is in control mode **AUTO<sub>ADAPT</sub>** or constant curve, the temperature influence cannot be set with the R100.

The temperature influence function can be activated in this display when the control mode is proportional pressure or constant pressure; see section 9.7.1 Control mode.

In the case of temperature influence, the pump must be installed in the flow pipe. It is possible to choose between maximum temperatures of 122 °F (50 °C) and 176 °F (80 °C).

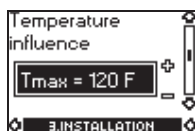

When the temperature influence is active, a small thermometer is shown in the display "Setpoint" in menu OPERATION, see section 9.5.1 Setpoint.

#### 9.7.4 Buttons on pump



To prevent unauthorized persons from operating the pump, the function of the buttons (⊕, ⊖ and ⊙) can be deactivated in this display. The buttons can be reactivated only with the R100.

The buttons can be set to:

- Active
- Not active.

#### 9.7.5 Signal relay



If an expansion module has been fitted, the signal relay function can be set in this display.

- Fault (functions as a fault signal relay)
- Ready (functions as a ready signal relay)
- Operation (functions as an operating signal relay).

#### 9.7.6 Pump number



A number from 1 up to and including 64 can be allocated to a pump or can be changed so that the R100, Grundfos Control MPC Series 2000 or other systems can distinguish between two or more pumps.

#### 9.8 Priority of settings

The external forced-control signals will influence the settings available on the pump control panel and with the R100. However, the pump can always be set to max. curve duty or to stop on the pump control panel or with the R100.

If two or more functions are activated at the same time, the pump will operate according to the setting with the highest priority.

The priority of the settings is as shown in the table.

**Example:** If the pump has been forced to stop via an external signal, the pump control panel or the R100 can only set the pump to max. curve.

#### With expansion module

Priority	Possible settings		
	Pump control panel or R100	External signals	Bus signal
1	Stop		
2	Max. curve		
3		Stop	Stop
4		Max. curve	Max. curve
5	Min. curve	Min. curve	Min. curve
6	Setpoint setting		Setpoint setting

Not active when the pump is controlled via bus.

Only active when the pump is controlled via bus.

As illustrated in the table, the pump does not react to external signals (max. curve and min. curve) when the pump is controlled via bus.

If the pump is to react to external signals (max. curve and min. curve), the system must be configured for that function.



For further details, please contact Grundfos.























## 10. Troubleshooting

**Warning**

*The pumped liquid may be scalding hot and under high pressure. Before any removal or dismantling of the pump, the system must therefore be drained or the isolating valves on either side of the pump must be closed.*

-  Indicator light is off.
-  Indicator light is on.
-  Indicator light is flashing.

Indicator lights		Fault	Cause	Remedy
Green	Red			
			One fuse in the installation is blown/tripped out.	Replace the fuse. Check that the electricity supply falls within the specified range.
		The pump is not running.	The current-operated or voltage-operated circuit breaker has tripped out.	Reset circuit breaker to ON position. Check that the electricity supply falls within the specified range.
			The pump may be defective.	Replace the pump or call Grundfos Service for assistance.
		The pump is not running.	The pump has been stopped in one of the following ways: 1. With the button  2. With the R100. 3. External on/off switch in position off. 4. Via bus signal.	1. Start the pump by pressing  2. Start the pump with the R100 or by pressing  3. Switch on the on/off switch. 4. Start the pump via bus signal.
		The pump has stopped due to a fault.	Electricity supply failure. Pump blocked and/or impurities in the pump.	Check that the electricity supply falls within the specified range. Dismantle and clean the pump.
			The pump may be defective.	Use the R100 for fault finding, see section 9.5.3 <i>Fault indications</i> . Replace the pump or call Grundfos Service for assistance.
		The pump is running but has a fault.	The pump has a fault, but is able to operate.	Try to reset the fault indication by briefly switching off the electricity supply or by pressing the button  ,  or  .
		The pump has been set to stop and has a fault.	The pump has a fault, but is able to operate (has been set to STOP).	Use the R100 for fault finding, see section 9.5.3 <i>Fault indications</i> . In case of repeated faults, contact Grundfos Service.

Indicator lights		Fault	Cause	Remedy
Green	Red			
☀	○	Noise in the system.	Air in the system.	Vent the system.
			The flow is too high.	Reduce the setpoint and possibly change over to AUTO <sub>ADAPT</sub> or constant pressure.
			The pressure is too high.	Reduce the setpoint and possibly change over to AUTO <sub>ADAPT</sub> or proportional pressure.
☀	○	Noise in the pump.	The inlet pressure is too low.	Increase the inlet pressure and/or check air volume in the expansion tank (if installed).
			Air in the pump.	Set the pump to "MAX" by continuously pressing the button  or with the R100. After venting  , set the pump back to normal duty by pressing the buttons  ,  or with the R100. <b>Note:</b> The pump must not run dry.

**Note** The R100 can also be used for fault finding.

## 10.1 Checking the module

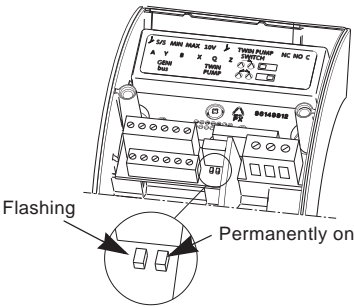
Illustration	Action
	<ol style="list-style-type: none"> <li>1. Remove the module cover.</li> <li>2. Check the LEDs. When the pump is switched on and the module is correctly mounted, the left LED must be flashing and the right LED must be permanently on.</li> <li>3. Refit the module cover.</li> </ol>

TM03 0892 0705

# 11. Megging

Megging of an installation incorporating a GRUNDFOS MAGNA pump is not allowed, as the built-in electronics may be damaged. If megging of the pump is necessary, the pump should be electrically separated from the installation.



## Warning

Before removing the cables, the electricity must be switched off.

Procedure:

### Megging of the pump

Step	Illustration	Action
1		<ul style="list-style-type: none"> <li>• Switch off the electricity supply.</li> <li>• Open the connection box.</li> </ul>
2		<ul style="list-style-type: none"> <li>• Remove the supply wires L and N and the earth ground wire (GND).</li> </ul>
3		<ul style="list-style-type: none"> <li>• Short-circuit the wires L and N using a wire.</li> <li>• Test between the wires L/N and earth ground (GND).</li> </ul> <p><b>Test voltage:</b> Max. 1000 VAC/1500 VDC. Maximum permissible leakage current &lt; 35 mA.</p> <p><b>Note:</b> Never test between the supply wires (L and N).</p>
4		<p>Test the cable to the pump.</p> <ul style="list-style-type: none"> <li>• Pull the plug out of the pump and test again.</li> <li>• Refit the supply wires L and N and the earth ground wire (GND).</li> <li>• Switch on the electricity supply.</li> </ul>

TM03 0908 0705

TM03 0909 0705

TM03 0910 0705

TM03 0911 0705

## 12. Technical data

### Supply voltage

1 x 208 - 230 V +/- 10 %, 50/60 Hz.

### Motor protection

The pump requires no external motor protection.

### Enclosure class

IP44.

### Insulation class

F.

### Relative air humidity

Maximum 95 %.

### Ambient temperature

+32 °F (+0 °C) to +95 °F (+35 °C).

### Temperature class

TF110 to EN 60335-2-51.

### Liquid temperature

+35 °F (+2 °C) to +200 °F (+93 °C).

### Maximum flow

- Max. 50 gpm.

### Maximum system pressure

- Max. 145 psi.

### Inlet pressure

Recommended inlet pressures:

- Min. 0.145 psi (0.10 bar) at 167 °F (+75 °C).
- Min. 5.08 psi (0.35 bar) at 200 °F (+93 °C).

### Sound pressure level

The sound pressure level of the pump is lower than 32 dB(A).

## Inputs and outputs of a pump with relay module

	Internal potential-free change-over contact. Maximum load: 250 V, 2 A, AC1. Minimum load: 5 V, 100 mA. Screened cable depending on signal level.
Signal output	
	External potential-free contact. Contact load: 5 V, 10 mA. Screened cable. Loop resistance: Maximum 130 Ω.
Input for external start/stop	

## Inputs and outputs of a pump with GENI module

	External potential-free contact. Contact load: 5 V, 1 mA. Screened cable. Loop resistance: Maximum 130 Ω.
Inputs for max. and min. curves	
	External signal: 0-10 VDC. Maximum load: 1 mA. Screened cable.
Input for analog 0-10 V signal	
	Grundfos bus protocol, GENIbus protocol, RS-485. Screened cable. Wire cross section: 0.25 - 1 mm <sup>2</sup> . Cable length: Maximum 3937 ft (1200 m).
Bus input	
	Internal potential-free change-over contact. Maximum load: 250 V, 2 A AC1. Minimum load: 5 V, 100 mA. Screened cable depending on signal level.
Signal output	
	External potential-free contact. Contact load: 5 V, 10 mA. Screened cable. Loop resistance: Maximum 130 Ω.
Input for external start/stop	

## 13. Disposal

This product or parts of it must be disposed of in an environmentally sound way:

1. Use the public or private waste collection service.
2. If this is not possible, contact the nearest Grundfos company or service workshop.

# Master pump

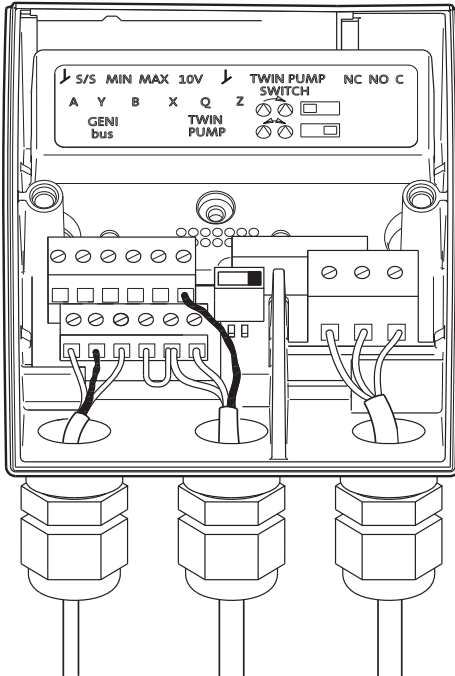
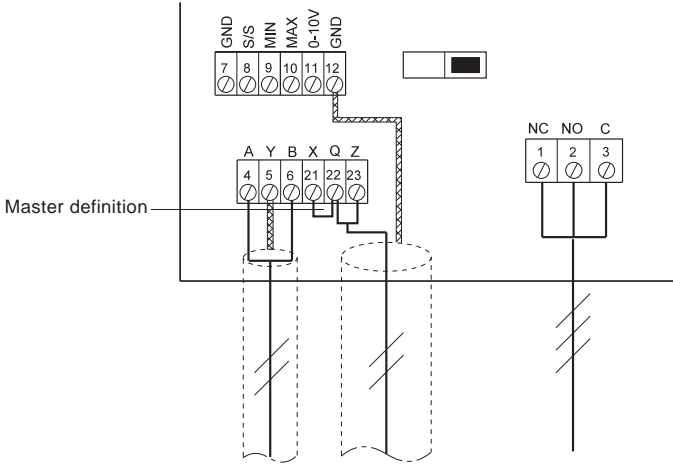

TM03 0857 0605

# Slave pump

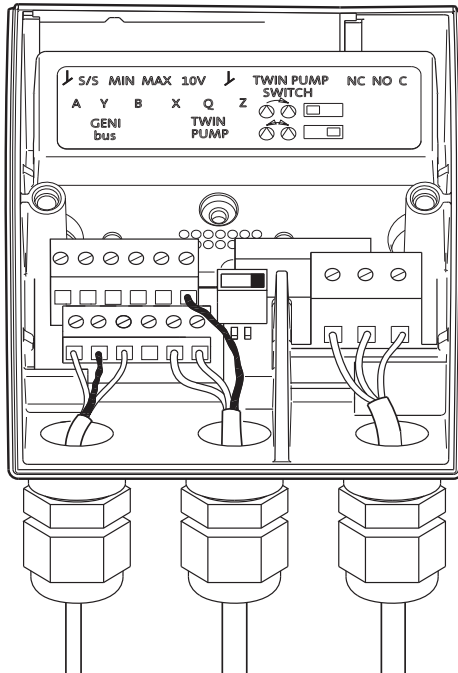
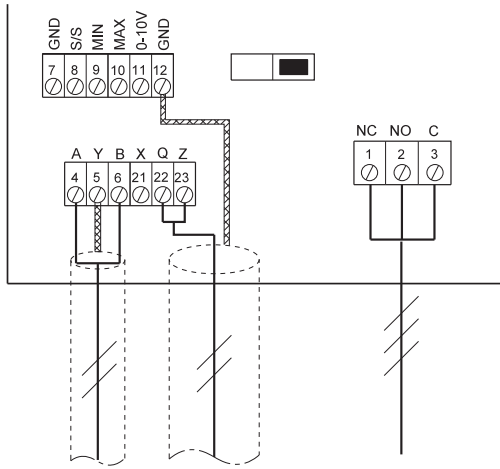

TM03 0856 0605

## **U.S.A.**

GRUNDFOS Pumps Corporation  
17100 West 118th Terrace  
Olathe, Kansas 66061  
Phone: +1-913-227-3400  
Telefax: +1-913-227-3500

## **Canada**

GRUNDFOS Canada Inc.  
2941 Brighton Road  
Oakville, Ontario  
L6H 6C9  
Phone: +1-905-829-9533  
Telefax: +1-905-829-9512

## **México**

Bombas GRUNDFOS  
de México S.A. de C.V.  
Boulevard TLC No. 15  
Parque Industrial Stiva  
Aeropuerto  
Apodaca, N.L.C.P. 66600  
Phone: +52-81-8144-4000  
Telefax: +52-81-8144-4010

**L-MAG-TL-03** 11.11

<b>97758317</b> 11.11	<b>US</b>
Repl. 10.11	

ECM: 1083640

© 2010 - 2011 Grundfos Pumps Corp.

The name Grundfos, the Grundfos logo, and the payoff Be-Think-Innovate are registered trademarks owned by Grundfos Management A/S or Grundfos A/S, Denmark. All rights reserved worldwide.

---