

The AEI LED SITEMAX LSX Series is perfect for a variety of wall-mounted and pole-mounted applications. With high lumen LED output, the SITEMAX LSX Series provides excellent illumination for a safe and comfortable exterior environment. The LSX offers unparalleled energy savings, making them perfect for replacing traditional wall, area and street lighting sources.

Not all products on this data sheet are qualified on the DLC QPL. To review our DLC qualified products, please consult the DLC 'Qualified Products List' at: www.designlights.org/qpl

LSX Series LSX-160, LSX-190, LSX-260 & LSX-320

POLE OR WALL MOUNT



LSX POLE MOUNT (190/260/320 shown)

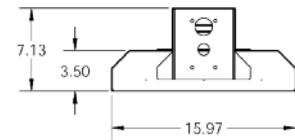
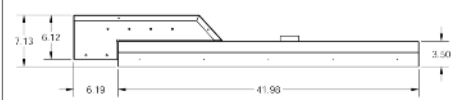
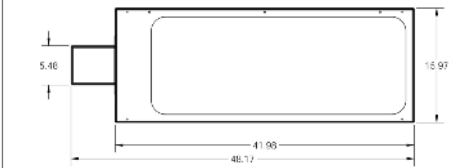

LSX WALL MOUNT (190/260/320 shown)

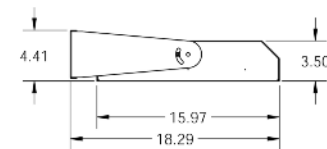
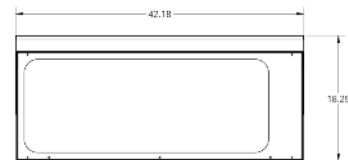
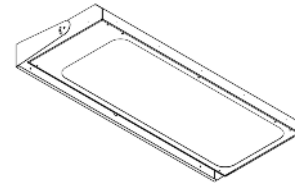

FEATURES

- USA-Made AEI Linear LED Light Engines
- High lumen LED output with multiple lumen output options
- Available in pole or wall mount
- Available in multiple colors and finishes
- 36,720 cold lumens - can be turned down to desired cold lumens
- Operating ambient temperature: -40C to 47C, -40F to 116.6F
- Integral sensors for daylight and occupancy available
- Custom reflector and mount for desired light distribution
- Cutoff optional diffuser for softer light
- 5-Year warranty on all fixture components

LENS & OPTICAL

- 100% impact modified acrylic lens, withstands wear & tear
- IP65 & IP67-Certified lens available in clear or frosted
- Available in 3000K, 4000K and 5000K CCT packages, each with 80+ CRI
- Lumens per model:
 - 14-16,000 lumens for the LSX-160
 - 17-19,000 lumens for the LSX-190
 - 24-26,000 lumens for the LSX-260
 - 28-32,000 lumens for the LSX-320
- L70 lumen maintenance >60,000 hours when operating within specified temperatures
- Different light distributions and beam angles available. Contact AEI for details.

ELECTRICAL

- Universal input voltage 90-305 VAC, with an option for 347 or 480 VAC
- 0-10 Volt dimming
- Photocell, occupation sensor, integration and control system options available

HOUSING

- Robust aluminum body, suitable for wet-locations
- Housing and Lens are IP65 Certified
- Textured housing back available. Contact AEI for details.

APPLICATIONS

- Street and roadway lighting
- Office park & commercial lighting
- Parking lot lighting
- Industrial yard lighting



LSX Series

POLE OR WALL MOUNT

LSX-160, LSX-190, LSX-260 & LSX-320



Not all products on this data sheet are qualified on the DLC QPL. To review our DLC qualified products, please consult the DLC 'Qualified Products List' at: www.designlights.org/qpl

SERIES DATA

LSX SERIES LUMINAIRE DATA							LIFE RATING (hours)		
Model	Lumens	# of LEDs	Dimensions	CCT	Distribution	L70	L80	L90	
LSX-160	160=16,000	162	1'x3' Nominal	3000K, 3500K, 4000K, 5000K	Type IV, V	98,000	61,000	29,000	
LSX-190	190=19,000	216	2'x3' Nominal	3000K, 3500K, 4000K, 5000K	Type IV, V	92,000	57,000	27,000	
LSX-260	260=26,000	288	2'x3' Nominal	3000K, 3500K, 4000K, 5000K	Type IV, V	89,000	55,000	26,000	
LSX-320	320=32,000	324	2'x3' Nominal	3000K, 3500K, 4000K, 5000K	Type IV, V	83,000	52,000	24,000	

DIMENSIONS & LIGHTING FACTS

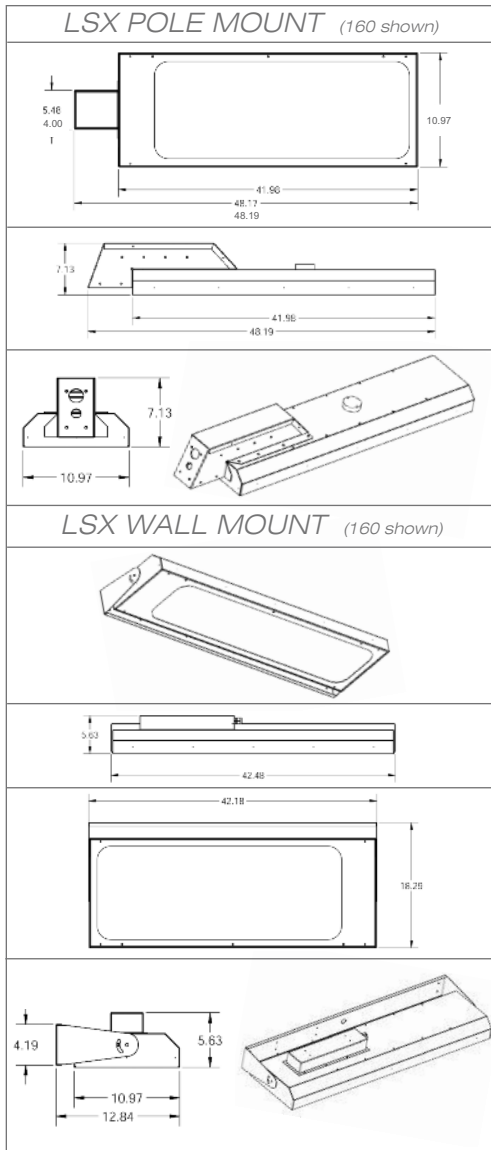

Advanced Energy Ideas

lighting facts
A Program of the U.S. DOE

Light Output (Lumens)	29390
Watts	320
Lumens per Watt (Efficacy)	91
Color Accuracy Color Rendering Index (CRI)	84
Light Color Correlated Color Temperature (CCT)	5296 (Daylight)
LED Lumen Maintenance Projection at 25,000 Hours at 25°C Ambient*	88.19%
Warranty**	Yes

All results, except LED Lumen Maintenance, are according to IESNA LM-79-2008: Approved Method for the Electrical and Photometric Testing of Solid-State Lighting. The U.S. Department of Energy (DOE) verifies product test data and results.

* Based on TM-21 projections for the light source.
** See www.lightingfacts.com/products for details.

Registration Number: 77B2-CQ23WC (6/14/2013)
Model Number: A-LSX-320-ALL-23-5K
Type: Outdoor area/roadway fixture



AEI LIGHTING

AEI LED SITEMAX LSX Series

WET / IP65 AREA & STREET LIGHTING

LSX Series LSX-160, LSX-190, LSX-260 & LSX-320

POLE OR WALL MOUNT



Not all products on this data sheet are qualified on the DLC QPL. To review our DLC qualified products, please consult the DLC Qualified Products List at: www.designlights.org/qpl

PHOTOMETRY

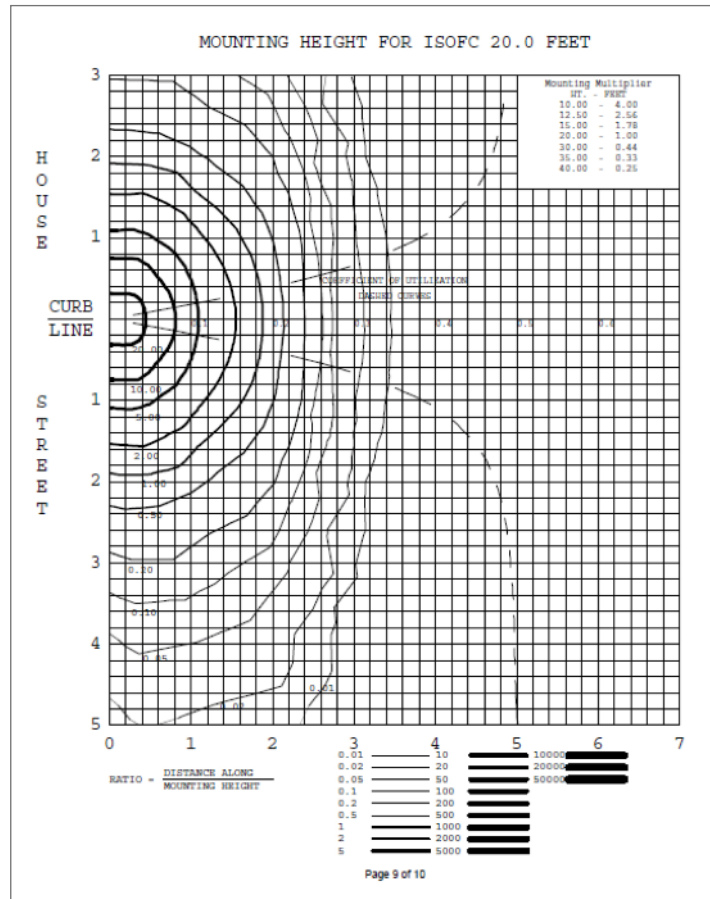
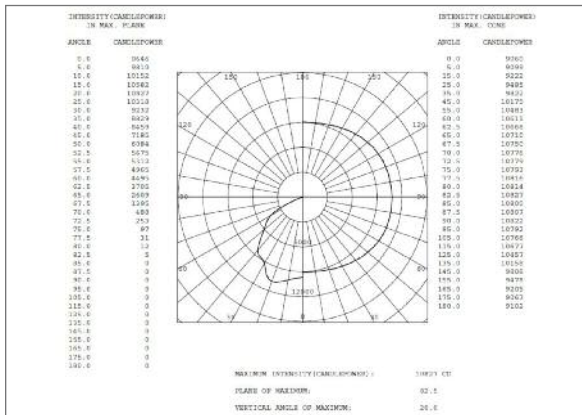
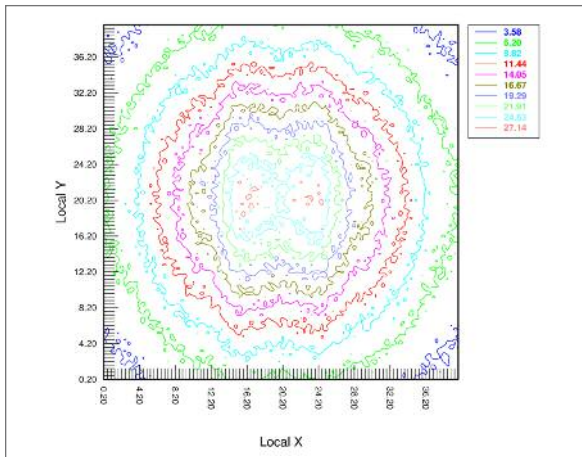

ORDERING GUIDE

Series	Model/Wattage	CCT	Voltage	Lens Type	Mounting	Options
LSX	MODEL / WATTAGE LSX-160=160-Watt LSX-190=190-Watt LSX-260=260-Watt LSX-320=320-Watt	CCT/LAMP COLOR 30K=3000K 40K=4000K 50=5000K Leave Blank if No Lamps Consult Factory For Custom Applications and Ordering Number	VOLTAGE UNI=90-305 VAC 347/480=347-480 VAC	LENS TYPE TG=TEMPERED GLASS PC=POLYCARBONATE TGFR=FROSTED TEMPERED GLASS PCFR=FROSTED POLYCARBONATE Consult Factory For Other Options	MOUNTING FM=FIXTURE END MOUNT WM=WALL MOUNT 20DEG=20 DEGREE TILT ADJ=ADJUSTABLE CM=CENTER MOUNT TT=TENON TOP MOUNT TR=TRUNION MOUNT	SENSORS Consult Factory For Sensor Options PHOTO CELL PC=Photo Cell Consult Factory For More Options COLORS The Standard Color is BRONZE Consult Factory For More Options OTHER Consult Factory For Custom Applications and Ordering Number

5-YEAR LIMITED WARRANTY
 VISIT AEILighting.com for Details
480-733-6594



AEI LED ITEMAX LSX Series WET / IP65 AREA & STREET LIGHTING