

MONUMENTS (IN RED) SOLD SEPARATELY

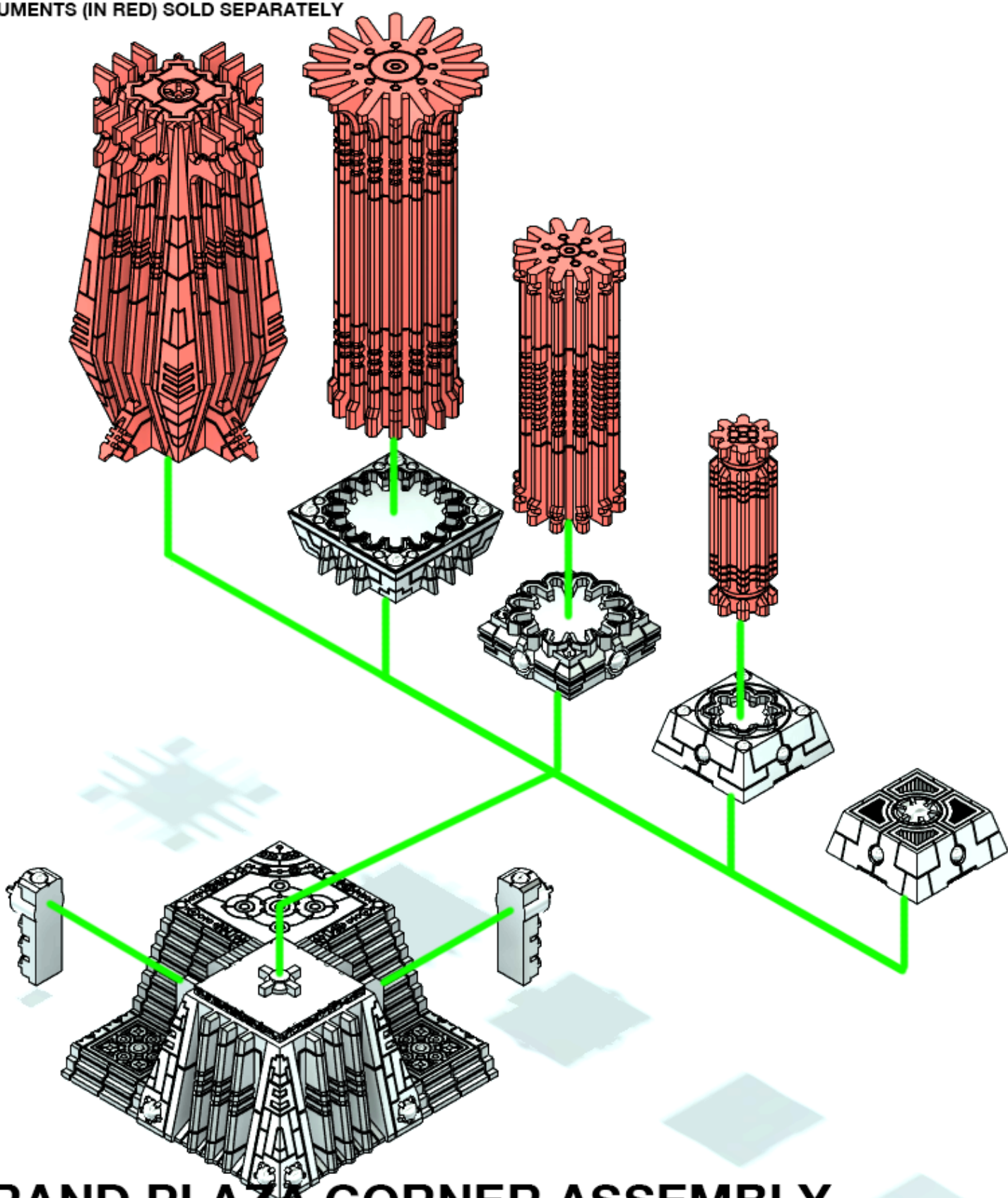

GRAND PLAZA CORNER ASSEMBLY

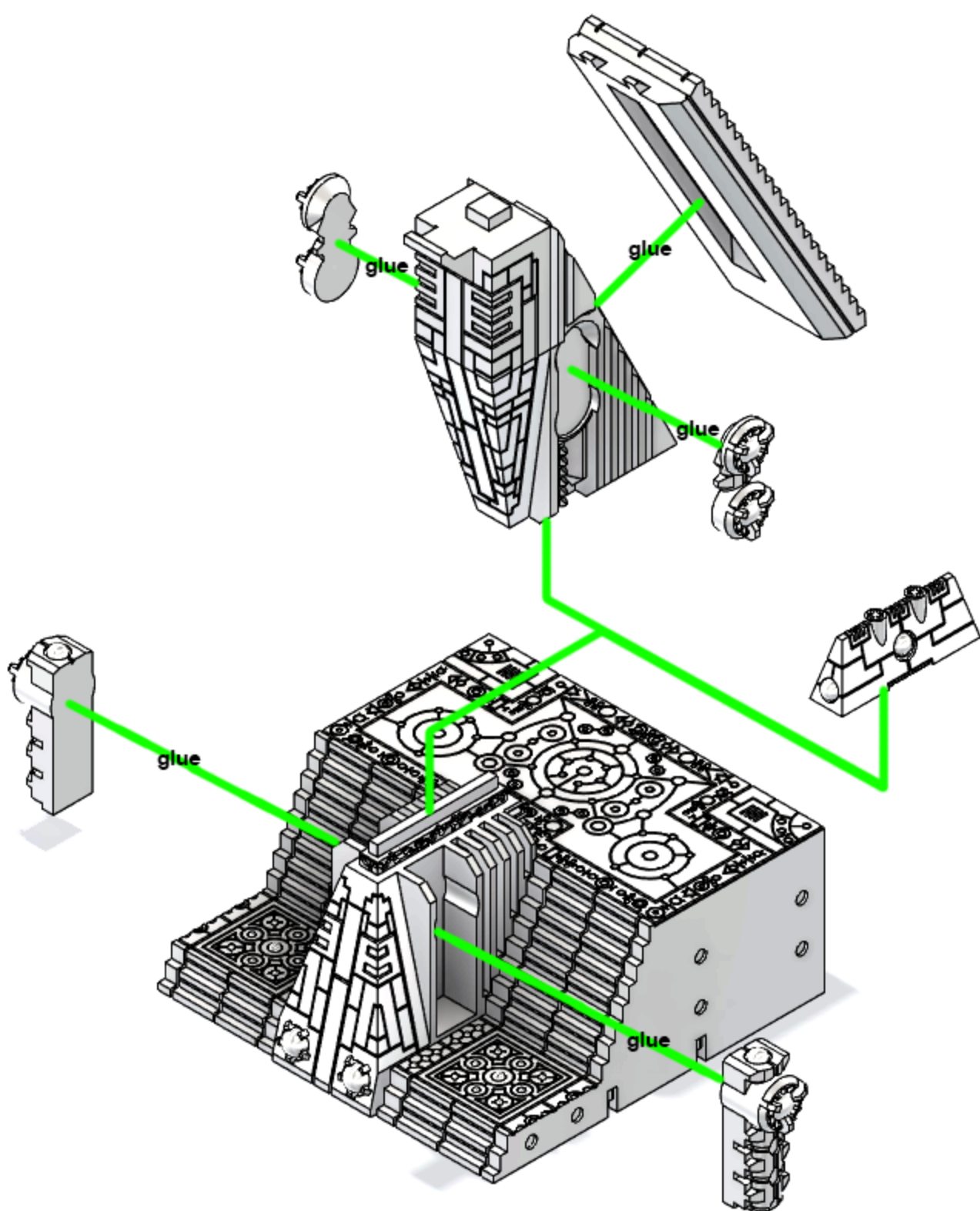

GRAND PLAZA SIDE ASSEMBLY

MONUMENTS (IN RED) SOLD SEPARATELY

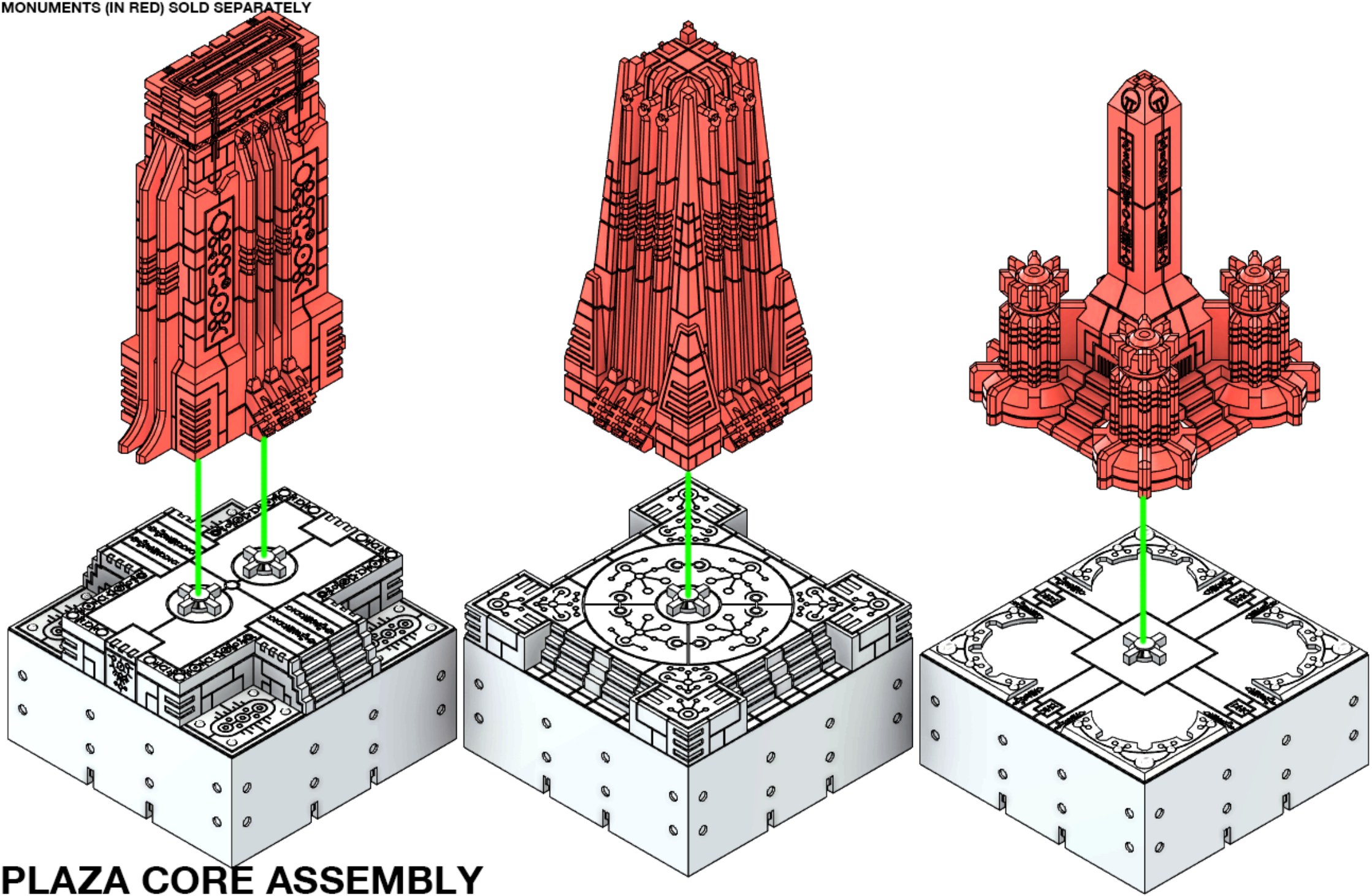

PLAZA CORE ASSEMBLY

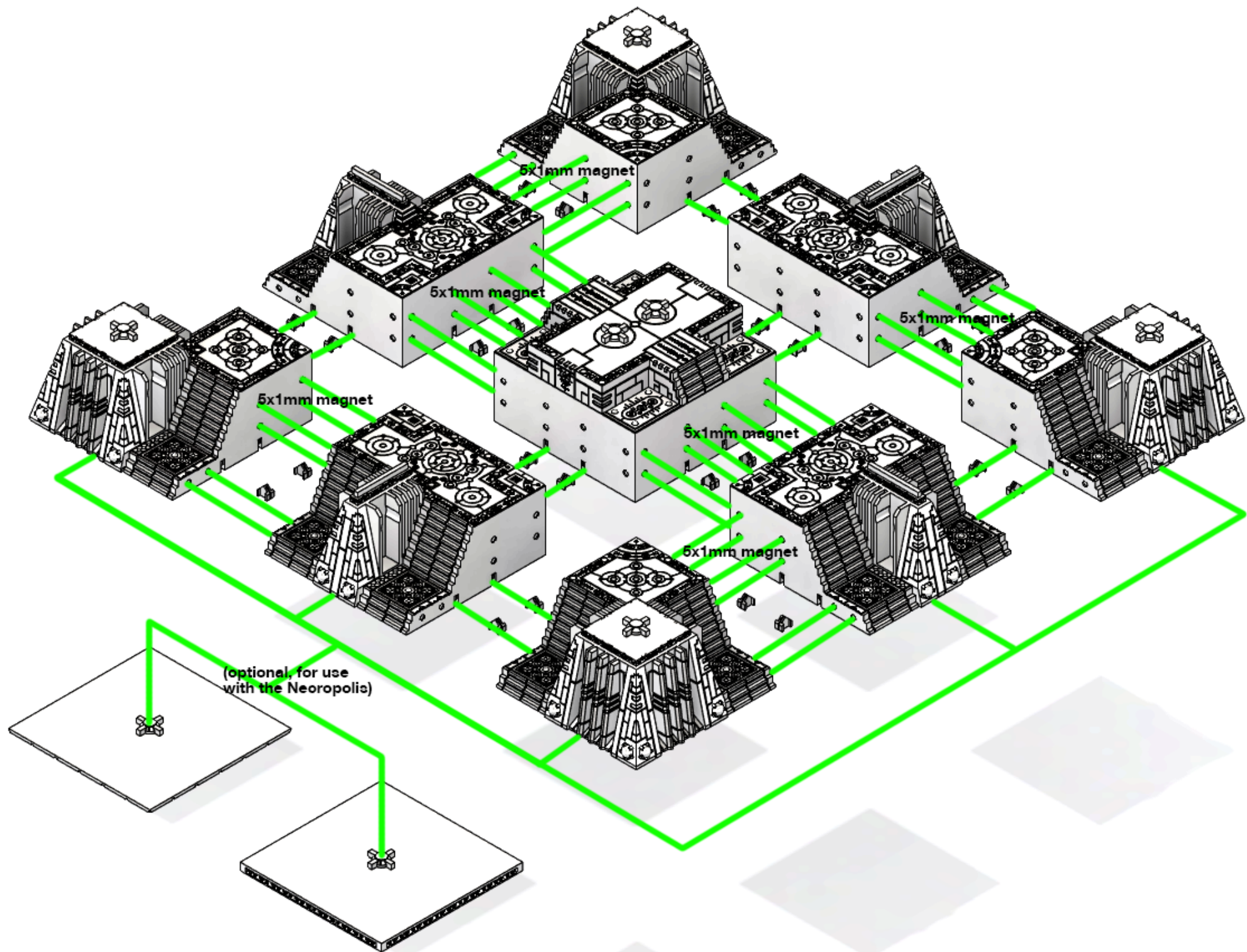

GRAND PLAZA ASSEMBLY

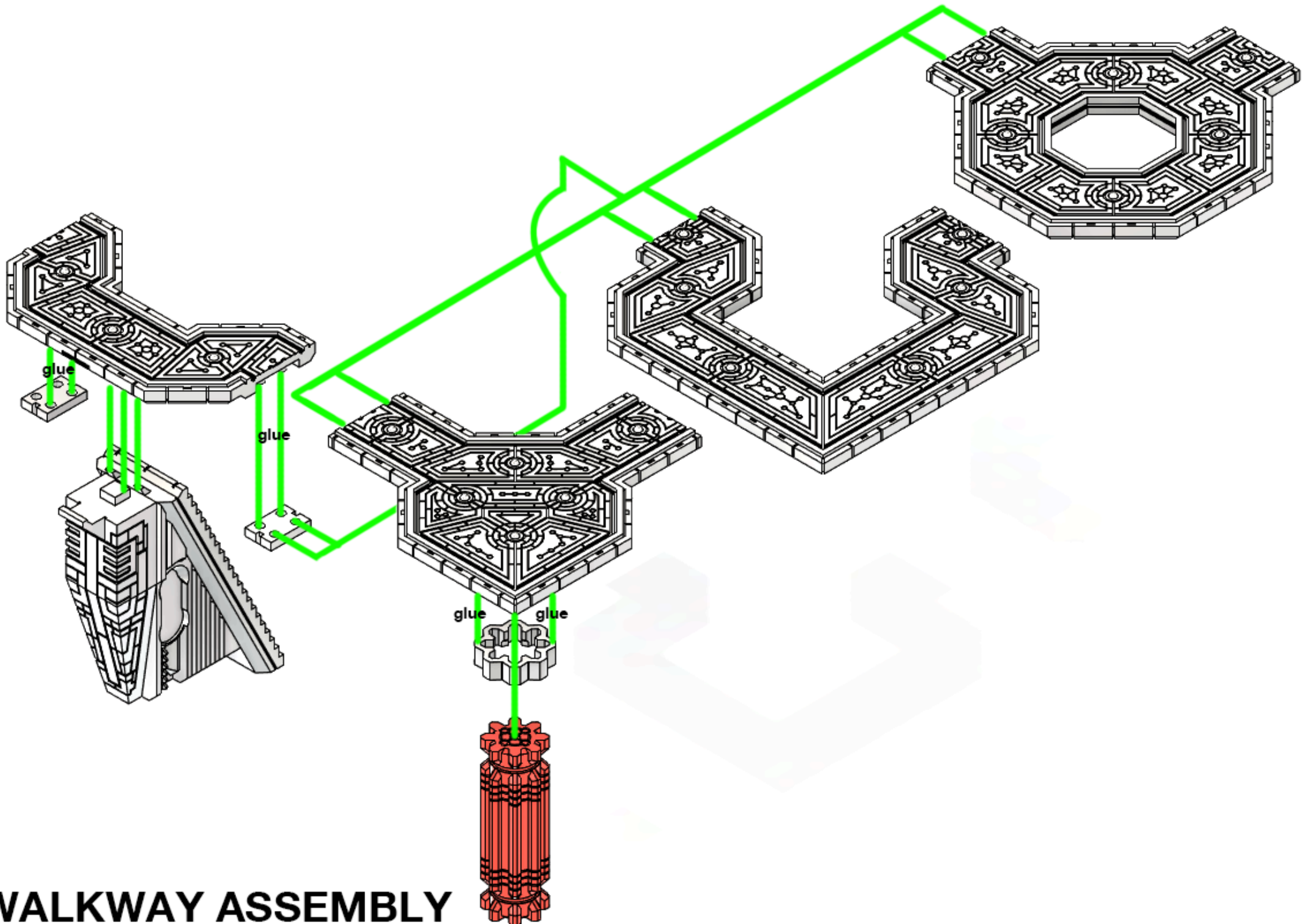

WALKWAY ASSEMBLY

SUBSTITUTE CONNECTOR PLUGS WITH 3.4mm x 3.4mm x 1.5mm MAGNETS
GLUED INTO POCKETS IN WALKWAY AND PARAPET BASE

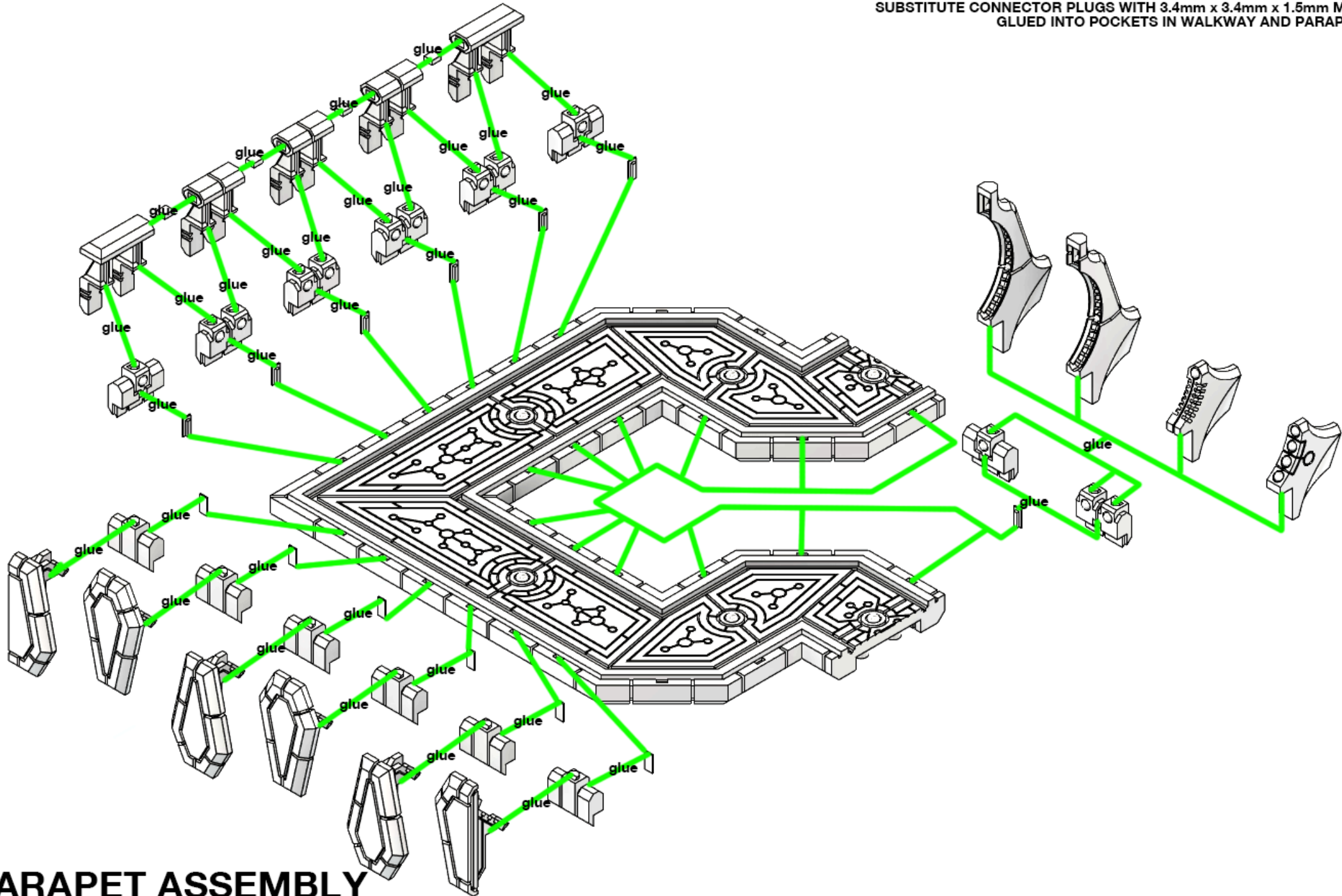

PARAPET ASSEMBLY

SLOT INTO GROOVES ON SIDES OF CORNER AND SIDE PIECES, POSITIONING SHOWN HERE FOR USE WITH RISER TOWER. NOTE THAT EXTRA LARGE BARRIER MAY NOT FIT UNDER RISER TOWER WHEN USED WITH TALL PLAZA TILES.

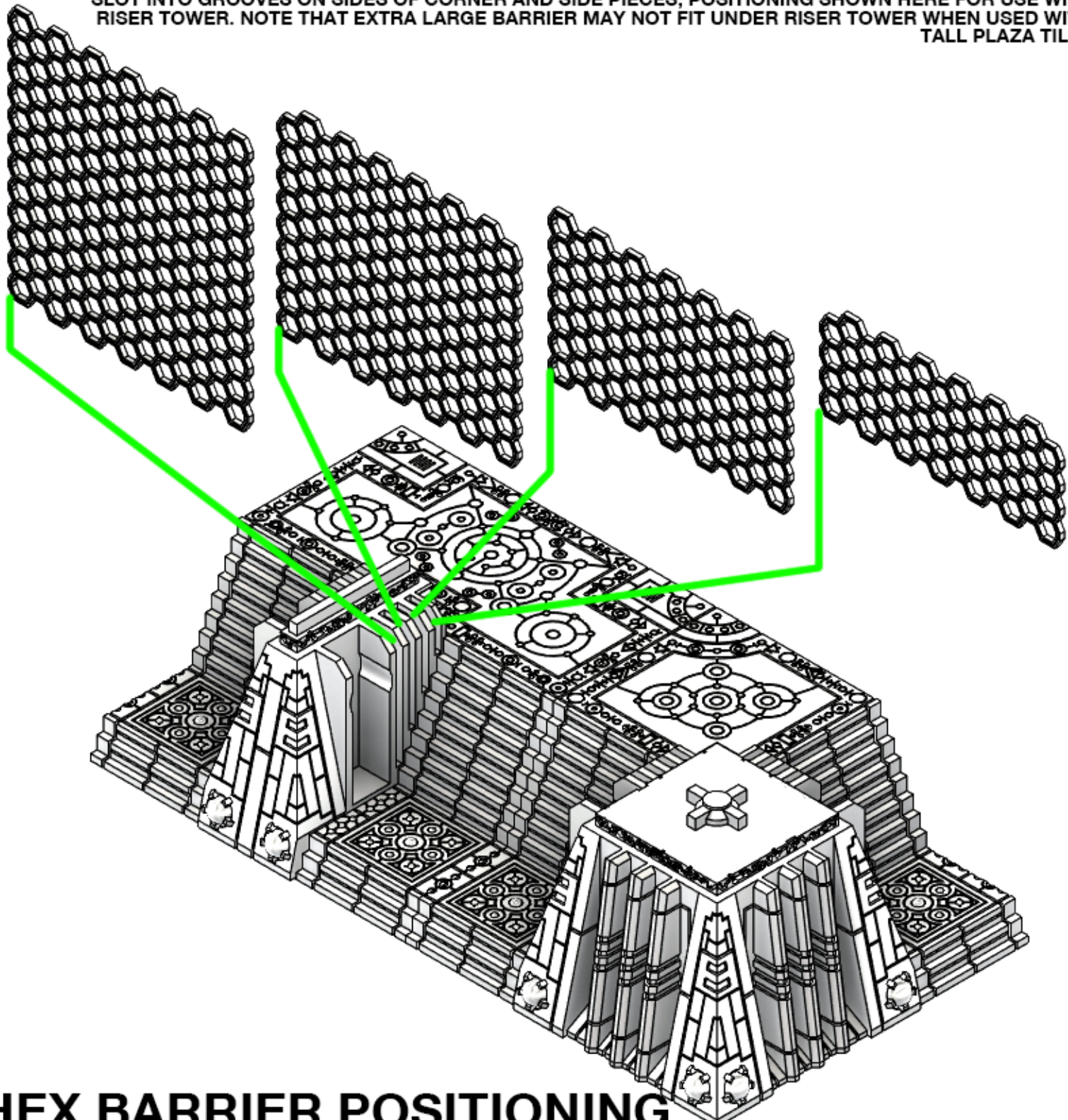

HEX BARRIER POSITIONING

