

M-Series & P-Series Catalog

2023

 **MITSUBISHI
ELECTRIC**
HEATING & AIR CONDITIONING





Table of Contents

Product Overview

History of Standard	4
Sustainability	5
2023 Minimum Efficiency Standard	6
Regulatory Changes by Region	7
Helping to Prevent Global Warming	8
Quality Assurance and Testing	9
Wired Controllers	10
Wireless Controllers	11

M-Series

Product Overview	12-22
M-Series Capacity Range	23
M-Series Features	24-25
MSZ-FS	26-29
MSZ-EF	30-31
MSY/Z-GS	32-34
MSZ-HM	36-37
MSZ-JP	38-39
MSZ-WR	40-41
MFZ-KJ	42-43
SUZ	44-45
MLZ	46-49
SVZ	50-52
SLZ-KF	53-56
SEZ-KD	58-60
PEAD	62-64

P-Series

Product Overview	67-70
P-Series Capacity Range	72-73
P-Series Features	74-75
PLA	76-80
PKA	82-86
PVA	88-92
PEAD	94-98
intelli-HEAT™	100-104
PCA	106-110

Multi-zone M-Series

Product Overview	113
Multi-zone Indoor Unit Connections	114
MXZ-C	116-117
MXZ-NAHZ	118-119
M-Series Indoor/Outdoor Unit Compatibility	120
P-Series Indoor/Outdoor Unit Compatibility	121
MXZ-NAHZ	118-119

SMART MULTI™

Product Overview	123
SMART MULTI™ Indoor Unit Connections	124
MXZ-SM Multi-zone Outdoor Heat Pumps	125
MXZ-SM Specifications	126-127

Appendix

Piping Installation	129
Additional M-Series Information	130-131
MXZ-C Piping Lengths	132-133
MXZ-SM Piping Lengths	134
Terminology Explained	135
Points to Remember when Installing	
Outdoor Units	136-137
System Control	138-139
Optional Parts	140-141
M-Series Heating Capacity	142-143
P-Series Heating Capacity	144-145
MXZ Heating Capacity	146
Additional P-Series Information	147
M-Series Model Reference Guide	148
P-Series Model Reference Guide	149



History of Innovation

For more than 30 years, Mitsubishi Electric's continuous innovation has brought unbeatable comfort and efficiency to homes and buildings of all shapes, sizes and uses. As a leader in advanced HVAC technologies, including Ductless and Ducted Mini-split and Variable Refrigerant Flow (VRF) heat pump and air-conditioning systems, we have a solution for any home, any building, anywhere. We continually innovate around efficiency, comfort and wellness in buildings or homes of all shapes and sizes by providing industry-leading products, design and technical training, and unmatched end-to-end support.

**A better way to heat and cool any home,
any building, anywhere.**



Sustainability

We are working to contribute to a more sustainable society by developing and promoting energy-saving all-electric products and systems, that will reduce the use of fossil fuels in the heating and cooling industry.

Our Commitment

Mitsubishi Electric promotes environmental sustainability through the electrification of residential and commercial heating and cooling products. We continue to advance technologies that reduce waste and promote sustainable resources while increasing energy efficiency and eliminating dependence on fossil fuels. We are committed to improving energy efficiency in all of our operations.

An Industry Changing

Strategic Electrification is the movement to replace fossil fuel-burning technologies with electricity-based alternatives to reduce pollution, increase energy efficiency, and reduce costs for consumers and society. Strategic Electrification in the heating and cooling industry is powering end uses with electricity instead of fossil fuels. Fossil fuel-free heating results in a reduction of greenhouse gas emissions (decarbonization), which is good for the environment, improves indoor air quality by reducing pollution, and with the zoning capabilities of Mitsubishi Electric systems, improves comfort and control.

“Our vision is clear: to align personal comfort with the greater societal good.”



INVERTER-Compressor Technology

Conventional systems are either on or off. All or nothing. Our compressors speed up or slow down based on the needs of each room to maintain comfort and conserve energy.



Room by Room Control

Divide your home into zones that best fit your family's needs. Save energy and maximize savings by creating your customized comfort zones.



ENERGY STAR®

Many of our systems are ENERGY STAR qualified and may be eligible for federal and state tax credits or local utility rebates.



2023 Department of Energy Minimum Efficiency Standard

On January 1, 2023, updated minimum efficiency standards for air conditioners, heat pumps, and mini-splits were introduced. These regulations require new testing procedures and reporting metrics, outlined below:

- Testing procedure changes include increased static pressure and airflow setpoint to reflect actual field conditions
- Equipment manufactured after January 1, 2023 must meet new regulations
- Equipment manufactured prior to January 1, 2023, can continue to be sold in the North region without restriction, but also in the Southeast and Southwest where able to meet 2023 standards
- SEER, EER, HSPF will be reported as SEER2, EER2, HSPF2

Regulatory Changes by Region

Compliance for 2023 air conditioners, heat pumps, and mini splits is based on the installation date or the manufactured date, depending on location. In the North region, an AHRI-rated matched system must be compliant on the day the manufacturer produces it. These systems can only be sold and installed in the North region. In the Southeast and Southwest regions, the installation date determines compliance.

Our innovative technology positions us well for this change. We continue to invest in design, engineering, materials, and testing to produce compliant products. We do this without hesitation to remain aligned with sustainability regulations and lead the way forward for the HVAC industry. As a result, we have the most extensive list of products that meet or exceed 2023 regulations in the North and Southeast, with only a few cooling-only exceptions in the Southwest.

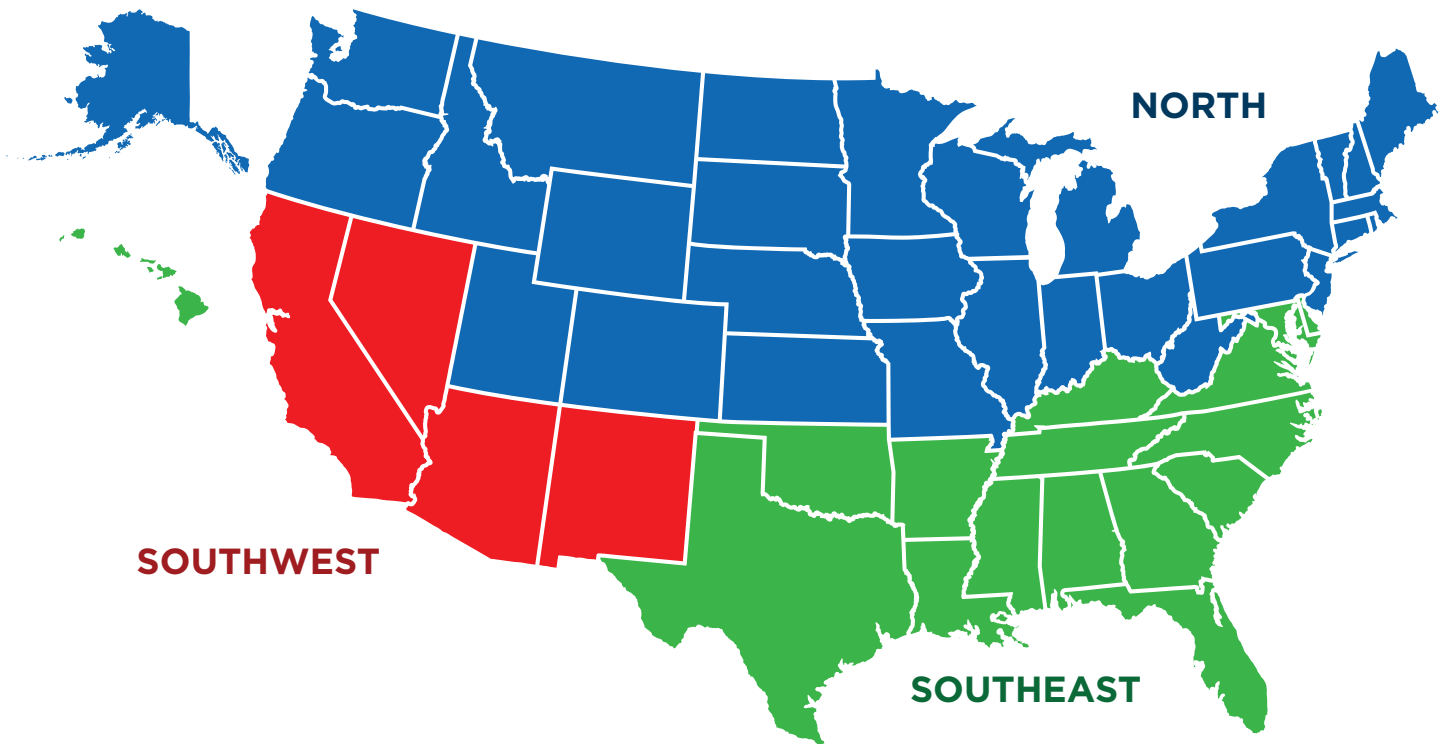

North Region			
Units manufactured after December 31, 2022.			
		SEER2	HSPF2
65,000 BTUH or less	AC	13.4	---
	HP	14.3	7.5

Southwest Region				
Units manufactured after December 31, 2022.				
		SEER2	HSPF2	EER2
45,000 BTUH or less	AC	14.3	---	11.7*
Greater than 45,000 BTUH	AC	13.8	---	11.2*
65,000 BTUH or less	HP	14.3	7.5	---

Southeast Region			
Units manufactured after December 31, 2022.			
		SEER2	HSPF2
45,000 BTUH or less	AC	14.3	---
Greater than 45,000 BTUH	AC	13.8	---
65,000 BTUH or less	HP	14.3	7.5

*9.8 EER2 if SEER2 ≥ 15.2

Helping to Prevent Global Warming

Heat pump technology inspires Mitsubishi Electric to design air conditioners that combine comfort and ecology. We develop technologies to achieve greater efficiency in heat pump operation.

	Comfort	Ecology
1. Inverter	Faster start-up and more stable indoor temperature than non-inverter units.	Fewer On/Off operations than with non-inverter systems.
2. 3D i-see Sensor®	When enabled, the sensor detects the location of people within a space. Customized airflow settings to move air directly toward or away from individuals provides personalized comfort.	The sensor detects the number of people in the space. When the space is detected to be vacant, the unit enters Energy Saving operation or may be set to automatically turn off.
3. Flash Injection	Achieves high heating capacity even at low temperatures plus faster start-up compared to conventional inverters.	Expands the geographical region covered by heat pump heating systems.

Heat Pump Principle (When Heating) <Case of COP of 4.0> Refrigerant and Heat Circulation

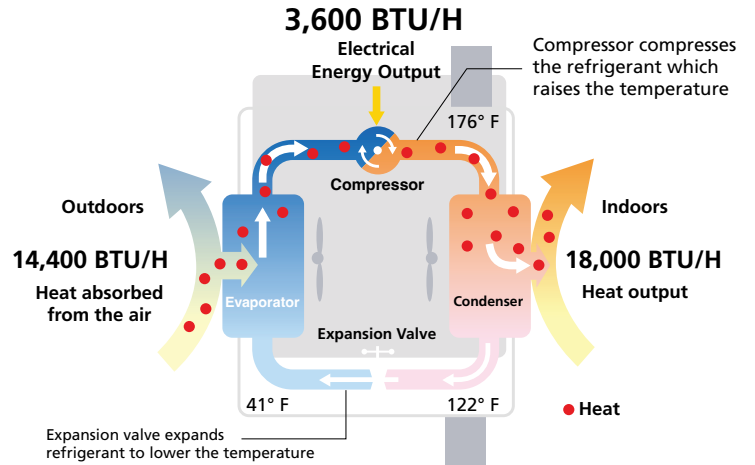

Quality Assurance and Testing

Cutting-edge technologies and uncompromising commitment to quality and reliability have made us one of the world's most trusted brands in air conditioning and refrigeration equipment and service.

Product Testing

Operating Tests in Harsh Conditions

Harsh environmental conditions of cold regions are simulated for the development of our heat pumps. This is one of the reasons customers in severely cold regions rely on us for comfortable heating.

Combustion Test

Products are subjected to a wide range of tests, including combustion testing, all to confirm safe operation under various conditions. Combustion testing is done by assuming accidental firing and replicating abnormal conditions that cause breakage of pressure components.

Shock Resistance Test

On the assumption of many different logistics environments in the world, we perform drop/strength tests, transport vibration tests, and many other product checks to assure that the quality and performance are maintained when the product reaches the user's home.

Waterproof and Corrosion Test

Since the outdoor unit is subject to rain, wind, and corrosive substances, potential problems are checked through tests such as showering the unit for a certain amount of time and increasing protection to enhance the lifespan of the unit.

Operation Noise Test

Operation noise tests are performed in an anechoic chamber with an extremely low 10 dB(A) of background noise. This is just one of the ways we ensure our customers enjoy extremely quiet heat pumps with a minimum operation noise of 19 dB(A) (sound pressure level).

Engineered Design

Engineers strive to achieve our philosophy of combining comfort and ecology in an effort to continually raise the bar. Therefore, we are working to further improve quality at all stages from development to production.

Efficient Production

Every air conditioner goes through a rigorous electrical inspection on the manufacturing line. In final testing, our experienced inspectors listen for even the faintest operation noise to detect any defect.



Wired Controllers



PAC-YT53CRAU-J

Simple MA Remote Controller

- Operation modes: Heat/Cool/Auto/Dry/Off
- Controls group operation for up to 16 indoor units in a single group
- Supports Fahrenheit and Celsius
- User defined functions:
 - Fan speed setting
 - Airflow direction
- Set temperature range: 40° F to 95° F depending on operation mode and indoor unit connected
- Set temperature range limit for cool and heat modes
- LOSSNAY®: Simple MA for interlocked system can set high/low/stop on LOSSNAY
- Room temperature can be sensed either at indoor unit (default) or at the remote controller
- Requires MAC-334IF-E for use with M-Series products



PAC-SDW01RC-1

SDW Remote Controller

- Three buttons and a dial with a color screen
- Wired communicating connection
- Field supplied 18 AWG wire up to 50 feet
- Standard operation commands
- Programmable
- English text error messages
- Auto DRY function (COOL -> DRY -> COOL)
 - Based on humidity set point



PAR-40MAAU

Deluxe MA Remote Controller

- Operation modes: Heat/Cool/Auto/Dry/Off
- Room temperature setting & range restriction
- Manual vane angle (P-Series cassette indoor units)
- Smooth maintenance (P-Series only)
- Auto-off timer & Weekly timer
- Setting screen for 3D i-see Sensor®
- Draft reduction mode
- Daylight Saving Time (DST)
- Requires MAC-334IF-E for use with M-Series ductless products
- Room temperature displays the temperature sensed either at the indoor unit (default) or at the controller



PAR-CT01MAU-SB

Touch MA Remote Controller

- User-friendly customizable full-color touch panel display
- Ability to add a custom logo on the display
- Large icons with 180 color patterns
- Daily and weekly timers
- Password protected
- Requires MAC-334IF-E for use with M-Series products
- The MELRemo app and Bluetooth® Low Energy (BLE) technology supports communication with smartphones or tablets in multiple languages
- Available on the Apple App store or Google Play App store



Wireless Control Interface Devices

USNAP Interface

- Allows indoor units to participate in demand response events
- Works with CTA 2045 DC Form Factor Universal Communication Modules (UCMs)
- 3 LEDs to display device status
 - Communication with UCM
 - Communication to indoor unit
 - Demand Response Events
- System Reset



PAC-WHS01UP-E

MAC-334IF-E System Control Interface

- Allows M-Series indoor units to communicate with the CITY MULTI® Controls Network via M-Net
- Provides an input to allow remote On/Off control of indoor unit
- Allows M-Series indoor units to connect to MHK2 Wall-Mounted Wireless Controller when using other MAC-334IF-E functions (can have the MHK2 or kumo cloud® wireless interface connected in this situation)
- Allows M-Series indoor units to connect to a MA controller
- Power: 12V DC (supplied from indoor unit)



MAC-334IF-E

Thermostat Interface

- Control your system using a third-party 24VAC transformer
- Wires back to the indoor unit using CN105 to replace the return air temperature sensor
- Maximum wiring length: 39" (12 m)
- Exterior shell made of ABS resin



PAC-US445CN-1

BACnet® Interface

- Allows for third-party home automation/building management system to control indoor unit
- One interface required per indoor unit
- Compatible with remote controllers
- Cable length: 37"



PAC-UKPRC001-CN-1

M-Series

Mini- and multi-split systems are perfect for residential room remodels or whole-home projects.



M-Series Product Range

Heat Pumps

A multiple model lineup to choose from, each with various outstanding features. In addition to INVERTER-equipped wall-mounted models, floor-standing and multi-position air handlers can be selected. Choose the best style to match usage needs.

Wall-mounted Style



 MSZ-FS Model



MSZ-EF Model



MSZ-GS Model



MSZ-GS Model



MSZ-HM Model,
MSZ-JP Model



MSZ-WR Model

EZ FIT® Recessed Ceiling Cassette



 MLZ Model

Multi-position Air Handler



 SVZ Model

Floor-mounted Style



 MFZ Model

Ceiling Cassette Unit Style



 SLZ Model

Horizontal-ducted Style



 SEZ Model



 PEAD Model

Cooling Only

For applications with needs for only cooling, there are cooling-only models to choose from.



MSY-GS Model



MSY-GS Model

Exclusive Features

3D i-see Sensor® Detection

Maintain your precise desired temperature with our sensor that scans the room and adjusts accordingly.

Detects Number Of People

The 3D i-see Sensor detects the number of people in the room and adjusts the power accordingly. This saves energy in places where the number of people changes frequently. Additionally, when the area is continuously unoccupied, the system switches to an advanced Power Saving Mode. Depending on the setting, it can also stop the operation.

Detects the Location of Individuals

The airflow in the space is entirely customizable. The user can choose Direct Airflow or Indirect Airflow configurations for each of the four air vanes. Once the sensor detects a person within the area, each air vane adjusts automatically to the preferred settings.

Highly Accurate Temperature Measurements

A total of eight sensors rotate a full 360° in 3-minute intervals. The sensor measures temperature throughout the space, and the algorithm determines the number of people within the area and their locations.

Room Occupancy Energy Saving Mode

The 3D i-see Sensor detects the number of people in the room. It calculates the actual occupancy rate as a percentage of the maximum number of people. When the occupancy rate is approximately 30%, the system energy savings is equivalent to 2° F during cooling or heating operation. The Energy Saving Mode algorithm controls the room temperature based on space occupancy.

Area Temperature Monitor

The 3D i-see Sensor monitors the whole room in small sections and directs the airflow to regions within the space as needed. For example, if the system is in cooling mode and the middle of the room is hot, then more airflow is directed toward the problem area to even out the room temperature. This smart feature eliminates unnecessary heating and cooling costs while delivering more uniform temperatures and comfort throughout the room.

Detects Number of People

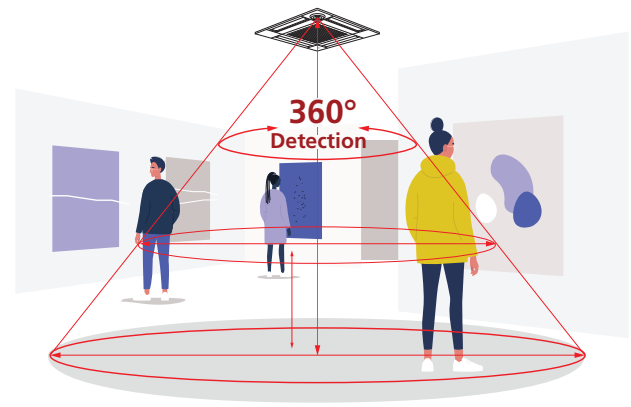

Detects Location of Individuals

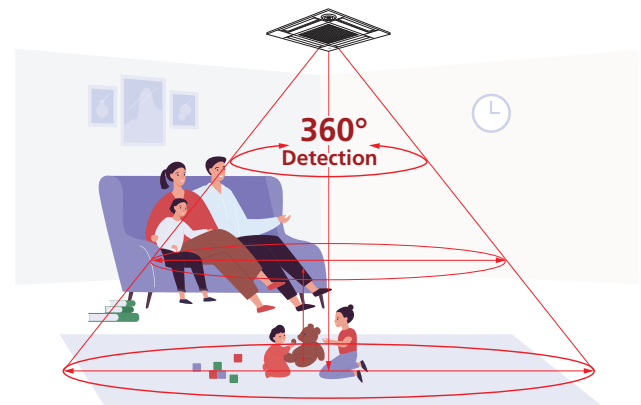

Room Occupancy Energy Saving Mode

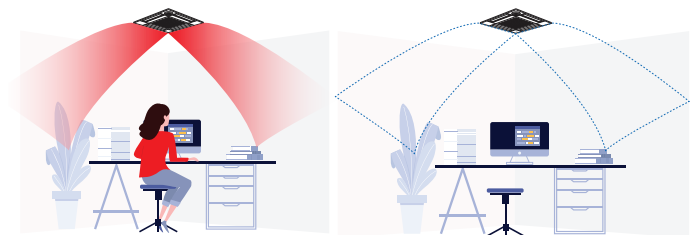

Area Temperature Monitor

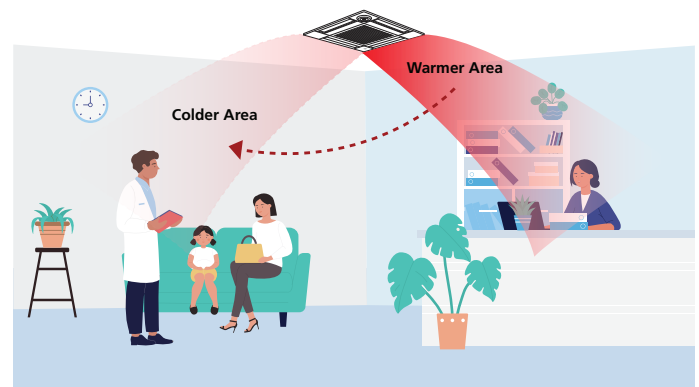



3D i-see Sensor® Airflow

No Occupancy Energy Saving Mode

When the 3D i-see Sensor detects that no one is in the room, the system switches to a preset power-saving mode. If the area remains unoccupied for more than 60 min, the system energy savings is equivalent to 4° F during cooling or heating operation. This mode reduces energy wasted on heating and cooling unoccupied rooms.

Direct/Indirect Settings

When set to Indirect Airflow, the vanes direct air horizontally across the ceiling away from individuals, eliminating drafts. The Direct Airflow setting blows conditioned air toward people within the space.

Seasonal Airflow

When Cooling: The unit saves energy while keeping a comfortable temperature by automatically switching between ventilation and cooling modes. Once the room reaches the desired temperature, the system switches from cooling mode to swing-fan operation to extend the amount of time the space maintains set point.



No Occupancy Energy Saving Mode



Indirect Airflow

Direct Airflow



When Heating: Once the room reaches the temperature set point, the system switches from heating mode to fan mode. The fan recirculates air throughout the space to prevent heated air from being wasted by collecting at the ceiling. This feature improves room comfort by eliminating annoying temperature differences caused by air stratification.



INVERTER Features

DC Fan Motor

A highly efficient DC motor drives the fan of the outdoor unit. Efficiency is much higher compared to an equivalent AC motor.

Grooved Piping

High-performance grooved piping is used in heat exchangers to increase the heat exchange area.

Heat Caulking Fixing Method

A Heat Caulking Fixing Method replaced arc spot welding to secure internal parts in place. This change reduces the distortion of internal components, resulting in additional efficiency gains.

Highly Efficient DC Scroll Compressor

Adding a frame compliance mechanism to the DC scroll compressor achieves further efficiency. The mechanism allows movement in the axial direction of the frame supporting the cradle scroll, thereby significantly reducing leakage and friction loss and ensuring high efficiency at all speeds.

Joint Lap DC Motor

Mitsubishi Electric has developed a unique motor, called the Poki-Poki Motor in Japan, manufactured using a joint lapping technique. This innovative motor operates based on a high-density, high-magnetic force, leading to extremely high efficiency and reliability.

Magnetic Flux Vector Sine Wave Drive

This drive device is a microprocessor that converts the compressor motor's electrical current waveform from a conventional waveform to a sine wave (180° conduction) to achieve higher efficiency by raising the motor winding utilization ratio and reducing energy loss.

PAM (Pulse Amplitude Modulation)

PAM is a technology controlling the current waveform to resemble the supply voltage wave, resulting in reduced loss and more efficient electricity use. PAM control effectively utilizes 98% of the input power supply.

Power Receiver and Twin LEV Control

Mitsubishi Electric developed a power receiver and twin linear expansion valve (LEVs) circuit that optimize compressor performance. This technology ensures ultimate control in response to the operating waveform and outdoor temperature. Tailoring the system to the characteristics of R410A refrigerant improves operational efficiency.

Reluctance DC Rotary Compressor

Powerful neodymium magnets used in the reluctance DC motor rotor produce strong magnetic torque and reluctance torque, resulting in more efficient operation.

Room Temperature Maintained

The inverter monitors the varying compressor motor frequency and creates the most efficient waveform for the motor speed. This results in improving operating efficiency at all speed ranges, using less power, and reducing annual electricity costs.

Grooved Piping

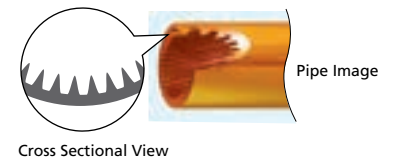

Highly Efficient DC Scroll Compressor

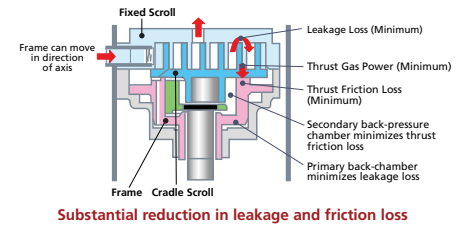

Joint Lap DC Motor



PAM (Pulse Amplitude Modulation)

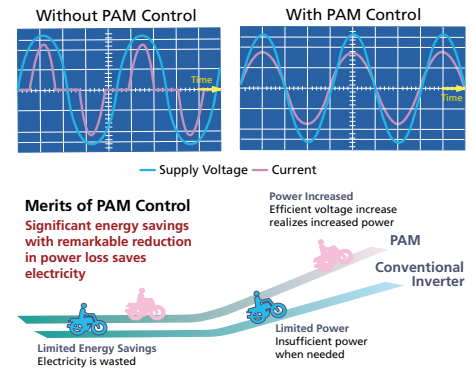

Power Receiver and Twin LEV Control

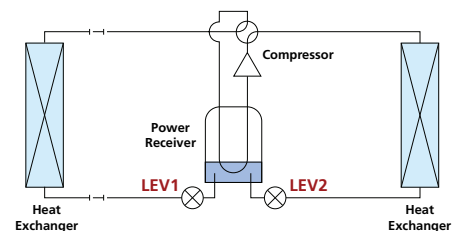

Reluctance DC Rotary Compressor

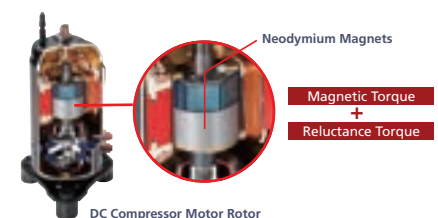

Energy Saving Features

Econo Cool Mode

Econo Cool is an intelligent temperature control feature that adjusts the amount of air directed toward the body based on discharge air temperature. The set point can be raised by 4° F without any loss in comfort, achieving an additional 20% energy efficiency.

Function only available during manual cooling operation

Temperature distribution (° F)
58 61 64 68 72 75 79 82



Conventional Cooling Mode



Econo Cool Mode

	Conventional	Econo Cool
Ambient Temperature	95° F	95° F
Set Point	77° F	81° F
Perceived Temperature	86° F	85° F

Demand Function (On-site Adjustment)

Based on the signal input, energy consumption can be reduced up to 100% of the typical consumption. The demand function can be activated by a commercially available timer or an on/off switch added to the CNDM connector (optional) on the outdoor unit control board.

SW7-1	SW1	SW2	Energy Consumption
ON	OFF	OFF	100%
	ON	OFF	75%
	ON	ON	50%
	OFF	ON	0% (Stop)

PUY/PUZ outdoor only. Example: P-Series Limit energy consumption by changing the settings of SW7-1, SW1 and SW2 on the control board of the outdoor unit. The following settings are possible.

Air Quality

Nano Platinum Filter

This filter has a large capture area and incorporates nanometer-sized platinum-ceramic particles that work to kill bacteria and deodorize the circulating air.

Catechin Filter

Catechin is a bioflavonoid byproduct of green tea with both antiviral and antioxidant qualities. In addition to improving air quality, it prevents the spreading of bacteria and viruses throughout the room, and also has an excellent deodorizing effect.

Air Filter

This filter removes dust particles from the air.

Deodorizing Filter

The catalyst coating on the honeycomb-structured frame captures small foul-smelling substances in the air, then breaks down the source of the odors with the power of the ozone generated in a plasma electrode unit.

Electrostatic Anti-allergy Enzyme Filter

This filter is charged with static electricity, enabling it to attract and capture dust particles that regular filters cannot. This filter can also trap allergens such as bacteria and decompose them using enzymes retained in the filter.

Air Purifying Filter

This filter has a large capture area and deodorizes the circulating air.

Fresh-air Intake

The direct intake of fresh exterior air enhances indoor air quality.

High-efficiency Filter

This high-performance filter has a much finer mesh compared to standard filters, and is capable of capturing minute particulates floating in the air that were not previously caught.

Oil Mist Filter

The oil mist filter prevents oil mist from penetrating the inner part of the air conditioner.

Long-life Filter

A special process for the entrapment surface improves the filtering effect, making the maintenance cycle longer than that of units equipped with conventional filters.

Filter Check Signal

The system monitors the air conditioner operating time, and the user is notified when filter maintenance is necessary.

Air Distribution

Double Vane

The double vane separates airflow into different directions to supply air across a wide area of the room and also reach people in two separate locations.

Natural Flow Operation

Airflow becomes more like a light breeze, and the occupant feels more comfortable.

Indirect/Direct Mode

This mode offers finely-tuned operation by locating where an occupant is in the room and sending the air directly or indirectly according to the selected mode.

Powerful Operation

The air conditioner will automatically adjust the fan speed and temperature for 15 minutes. Rapid cooling and heating will make the room comfortable more quickly.

Wide Airflow

Especially beneficial for large spaces, helping to ensure that the air is well circulated and reaches every corner of the room. Select the desired airflow pattern, and it will distribute air horizontally over a wide-ranging 150° in heating mode and 100° in cooling mode.

Vertical Vane

The air outlet fin swings from side to side so that the airflow reaches every part of the room.

High Ceiling Mode

In the case of rooms with high ceilings, the outlet-air volume can be increased to ensure that air is circulated all the way to the floor.

Low Ceiling Mode

If the room has a low ceiling, the airflow volume can be reduced for less draft.

Auto Fan Speed Mode

The airflow speed mode adjusts the fan speed of the indoor unit automatically according to the present room conditions.

Auto Vane Control

Outlet vanes can be moved left and right, and up and down, using the remote controller. This improved airflow control feature solves the problem of drafts.

Horizontal Vane

The air outlet vane swings up and down so that the airflow is spread evenly throughout the room.

Blue Fin Coating

Blue Fin Heat Exchanger

Anti-corrosion treatment is applied to the heat exchanger of the outdoor units. This coating prevents the corrosion of the aluminum fins caused by salt in the air, especially in coastal areas.

Corrosion of the heat exchanger will affect the efficiency and performance of the air conditioner.

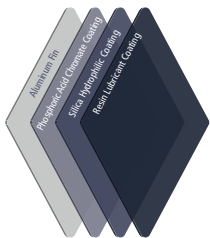

Standard HEX Coatings:
Rated for 240 hours spraying time*

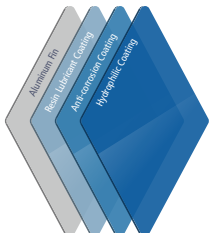

Blue Fin HEX coatings:
Rated for 2,000 hours spraying time*

*ASTM B117 Standard Coating is applied on all M-Series single-zone outdoor units

Compatibility	
Outdoor Unit	Indoor Unit
MUZ-FS	√
MUFZ-KJ	√
MUZ/Y-GS	√
MUZ-HM	√
MUZ-JP	√
MUZ-WR	√
SUZ-KA-NAZ (9,12,15)	√
SUZ-KA-NAHZ (9,12,15,18)	√
MXZ-SM Smart Multi™ (Branch box Type)	√

Convenience

Smart Set

Smart Set is a simplified setting function that recalls the preferred (preset) temperature by pressing a single button on the remote controller. Press the same button twice to immediately return to the previous temperature setting. Using this function contributes to comfortable waste-free operation, realizing the most suitable air conditioning settings and saving on power consumption when, for example, leaving the room or going to bed.

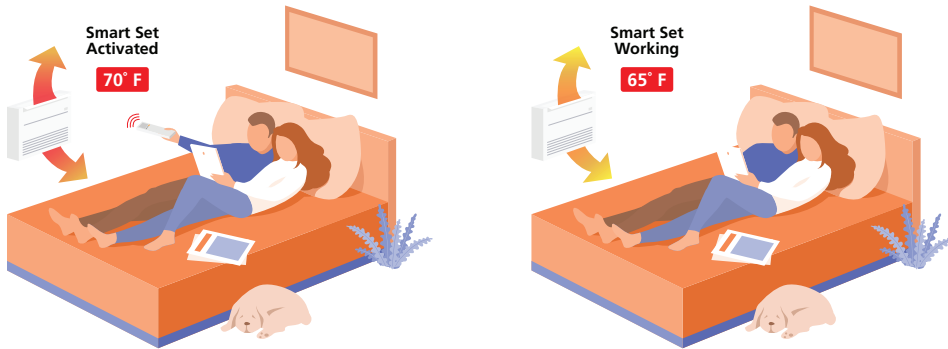

Auto Changeover

The air conditioner automatically switches between heating and cooling modes to maintain the desired temperature.

Low-Temperature Cooling

Intelligent fan speed control in the outdoor unit ensures optimum performance even when the outside temperature is low.

Ampere Limit Adjustment

Dip switch settings can adjust the maximum electrical current for operation. This function is highly recommended for managing energy costs.

Auto Restart

Especially useful during of power outages, the unit turns back on automatically when power is restored.

Operation Lock (Outdoor Unit)

To accommodate specific-use applications, cooling or heating operation can be specified when setting the control board of the outdoor unit. This is a convenient option when a system needs to be configured for exclusive cooling or heating.

Sleep Mode

When Sleep Mode is activated using the wireless remote controller, it will switch to the settings described below.

- After 30 minutes, the temperature will automatically change to the sleep mode temperature, which the user can set beforehand.
- The fan speed will immediately change to low fan speed.

On/Off Operation Timer

Use the remote controller to set the times of turning the air conditioner On/Off.



FS Remote - Open

Exclusive Features

Weekly Timer Function

Easily set desired temperatures and ON/OFF times to match lifestyle patterns. Reduce wasted energy consumption by using the timer to prevent forgetting to turn off the unit and eliminate temperature setting adjustments.

Sample Operation Pattern (Winter/Heating Mode)

	Mon.	Tues.	Wed.	Thurs.	Fri.	Sat.	Sun.
6:00 AM	ON 68° F	ON 68° F	ON 68° F	ON 68° F	ON 68° F	ON 68° F	ON 68° F
8:00 AM	Automatically changes to high-power operation at wake-up time						
10:00 AM	OFF	OFF	OFF	OFF	OFF	ON 64° F	ON 64° F
12:00 AM	Automatically turned off during work hours					Midday is warmer, so the temperature is set lower	
2:00 PM							
4:00 PM							
6:00 PM	ON 72° F	ON 72° F	ON 72° F	ON 72° F	ON 72° F	ON 72° F	ON 72° F
8:00 PM	Automatically turns on, synchronized with arrival at home					Automatically raises temperature setting to match time when outside-air temperature is low	
10:00 PM							
(Sleeping Hours)	ON 64° F	ON 64° F	ON 64° F	ON 64° F	ON 64° F	ON 64° F	ON 64° F
	Automatically lowers temperature at bedtime for energy-saving operation at night						

Settings

Pattern Settings: Input up to four settings for each day Settings: Start/Stop operation, Temperature setting
The operation mode cannot be set



Set a Weekly Timer

Start by pushing the "SET" button and following the instructions to set the desired patterns. Once all of the desired patterns are input, point the top end of the remote controller at the indoor unit and push the "SET" button one more time. (Push the "SET" button only after inputting all of the desired patterns into the remote controller memory. Pushing the "CANCEL" button will end the set-up process without sending the operation patterns to the indoor unit). It takes a few seconds to transmit the Weekly Timer operation patterns to the indoor unit. Please continue to point the remote controller at the indoor unit until all data has been sent.

System Control

M-NET Connection

Units can be connected to MELANS system controllers (M-NET controllers) such as the AE-200A.

kumo cloud® Wireless Interface

With your smartphone or tablet device, you can manage your system in multiple venues, such as home, work and vacation locations. You can control functions like turning on/off, fan speed, and vane direction.

MXZ Connection

Connection to the MXZ multi-split outdoor unit is possible.

System Group Control

The same remote controller is capable of controlling the operational status of up to 16 refrigerant systems.





kumo cloud®

kumo cloud gives you the ability to control your home's comfort effortlessly. Whether you're out for the day or out for the month, looking to cool down or warm up, kumo cloud gives you control from any smart device or web browser.



Wireless Router Compatibility

kumo cloud is compatible with most wireless routers, making it easier to integrate into existing wireless networks or switch to a new router.



Program and Schedule

kumo cloud setup walks through a simple process to easily schedule modes, program temperature, and select fan speeds for all zones or one at a time.



Auto Changeover

kumo cloud contains advanced logic to automatically change a multi-room system from cooling to heating and back based on comfort needs.



Compatibility

kumo cloud is compatible with many Mitsubishi Electric systems, including M-Series and P-Series.



Easily Zoned

The kumo cloud app discovers active wireless interface devices. Once located, each zone can be named and organized into groups.



IFTTT Applet Integration

Expand your heating and cooling system with IFTTT Applet integration. Control transfer fans, lighting and much more.



Simple Setup

Intuitive initial settings and Bluetooth® pairing for easy M-Series and P-Series zone discovery makes it simple to get kumo cloud up and running.



Check Filter Status

You never have to manually check a filter again. kumo cloud can tell you the status of any filter in your system at any time.



Simplified Programming





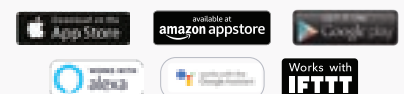
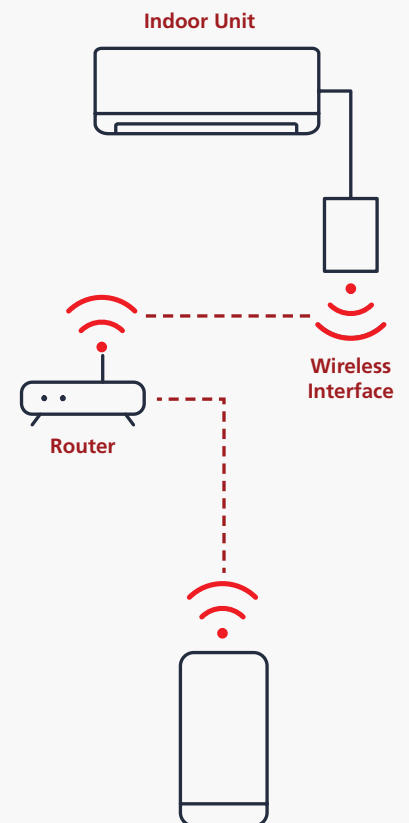

Easy-to-set scheduling features allow you to manage your system anytime, anywhere for the most efficient operation.



kumo cloud® System Configuration

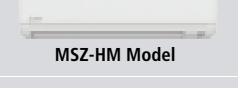
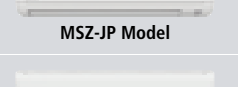
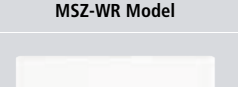

M-Series Capacity Range

	Model	6,000 BTU/H	9,000 BTU/H	12,000 BTU/H	15,000 BTU/H	18,000 BTU/H	24,000 BTU/H	30,000 BTU/H	36,000 BTU/H
Wall-mounted	 MSZ-FS Model	•	•	•	•	•			
	 MSZ-EF Model		•*1	•*1	•*1	•*1			
	 MSZ-GS (6-24) MSZ-GS (30-36)	•*1	•	•	•	•	•	•	•
	 MSZ-HM Model		•*2	•*2	•*2	•*2	•*2		
	 MSZ-JP Model		•*2	•*2					
	 MSZ-WR Model		•*2	•*2		•*2	•*2		
	 MSY-GS Model (Cooling Only)		•*2	•*2	•*2	•*2	•*2	•*2	•*2
Floor-mounted	 MFZ-KJ Model		•	•	•	•			
EZ FIT® Recessed Ceiling Cassette	 MLZ Model	•*1	•	•		•			
Horizontal-ducted	 SEZ-KD Model		•	•	•	•			•
Ceiling Cassette	 SLZ-KF Model		•	•	•	•*2			
Multi-position Air Handler	 SVZ Model			•		•	•	•	•

*1 MXZ connection only *2 Single-zone connection only

M-Series Features

Category	Feature	Indoor Unit	M-Series																	
			MSZ-FS06/09/12/15/18NA						MSZ-EF09/12/15/18NA(W)(B)(S)						MSZ-GL06/09/12/15/18/24NA					
			Outdoor Unit	MUZ-FS	MXZ-2C	MXZ-3C	MXZ-4C	MXZ-5C	MXZ-8C	MXZ-2C	MXZ-3C	MXZ-4C	MXZ-5C	MXZ-8C	MUZ-GL	MXZ-2C	MXZ-3C	MXZ-4C	MXZ-5C	MXZ-SM
Functions	i-see Sensor™	Radiant Temperature Control (3D i-see Sensor®)	•	•	•	•	•	•												
		AREA Temperature Monitor	•	•	•	•	•	•												
	Energy Saving	Econo Cool	•	•	•	•	•	•	•	•	•	•	•	•	•	•	•	•	•	•
		Air Quality	Nano Platinum Filter	•	•	•	•	•	•	•	•	•	•	•	•	•	•	•	•	•
	Catechin Filter																			
	Air Cleaning Filter																			
	Deodorizing Filter		•	•	•	•	•	•												
	Electrostatic Anti-Allergy Enzyme Filter		•	•	•	•	•	•	•	•	•	•	•	•	24	24	24	24	24	24
	Anti-Allergy Enzyme Filter														06-18	06-18	06-18	06-18	06-18	06-18
	Air Purifying Filter																			
	Air Distribution	Double Vane	•	•	•	•	•	•												
		Horizontal Vane	•	•	•	•	•	•	•	•	•	•	•	•	•	•	•	•	•	•
		Vertical Vane	•	•	•	•	•	•							18/24	18/24	18/24	18/24	18/24	18/24
		Natural Flow Operation	•	•	•	•	•	•												
		Wide Airflow													24	24	24	24	24	24
		Indirect/Direct Airflow	•	•	•	•	•	•												
		Powerful Operation	•	•	•	•	•	•							24	24	24	24	24	24
	Convenience	Smart Set	•	•	•	•	•	•	•	•	•	•	•	•	06-18	06-18	06-15	06-18	06-18	06-18
		Auto Restart	•	•	•	•	•	•	•	•	•	•	•	•	•	•	•	•	•	•
		Low Temperature Cooling	•	•	•	•	•	•	•	•	•	•	•	•	•	•	•	•	•	•
Sleep Mode																				
12H On/Off Operation Timer																				
24H On/Off Operation Timer		•	•	•	•	•	•	•	•	•	•	•	•	•	•	•	•	•	•	
Weekly Timer		•	•	•	•	•	•	•	•	•	•	•	•							
Maintenance	Blue Fin	•			•*1	•*1	•				•*1	•*1	•			•	•*1	•*1	•	
	Dual Barrier Coating	•																		

*1 Branch box units only: MXZ-SM36NAMHZ-U1, MXZ-SM42NAMHZ-U1, MXZ-SM48NAMHZ-U1, MXZ-SM36NAM-U1, MXZ-SM48NAM-U1, and MXZ-SM60NAM-U1 *2 Sea coast protection models only (-BS)
 Opt: Separate parts must be purchased.

MSZ-FS

Wall-mounted Indoor Unit

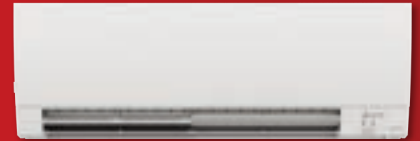

Deluxe Indoor Unit

The MSZ-FS Deluxe Wall-mounted Indoor Unit features a 3D i-see Sensor® and offers dual vane operation. The unit's interior air duct/vane, coil, and fan features Dual Barrier Coating, which maintains efficiency by keeping the inside clean. The MSZ-FS offers triple filtration, a backlit hand controller, and other premium features.

Capacities: 6,000 to 18,000 BTU/H

Sound: As low as 20 dB(A)

SEER2: Up to 32.2

HSPF2: Up to 11.90

COP: Up to 4.68

ENERGY STAR®: Yes





Dual Barrier Coating

The patented Mitsubishi Electric Dual Barrier Coating prevents dust and dirt from accumulating on the inner surface of the heat pump, keeping your unit clean year-round. Blended fluorine particles prevent hydrophilic dirt penetration, and hydrophilic particles prevent hydrophobic dirt from getting into the heat pump.

3D i-see Sensor®

The 3D i-see Sensor is an infrared-ray sensor that measures temperatures at different positions throughout the space. While scanning the area from left to right, eight vertically arranged sensor elements analyze the room temperature in three dimensions. Based on temperature readings, the sensor detects the location of people in the room.



H2i plus® Hyper-heating Performance

H2i plus hyper-heating heat pump technology is leading technology in the industry. The H2i plus outdoor units produce up to 100% heating capacity down to -5° F.

Triple-action Filtration

Our indoor units continuously clean the air of allergens, dust, viruses, and bacteria. Each room's indoor unit is equipped with filters to directly improve your air quality, while the conventional system has only one filter installed in the central unit. The filters are washable and last up to 10 years, which saves you money on maintenance.

MSZ-FS Specifications

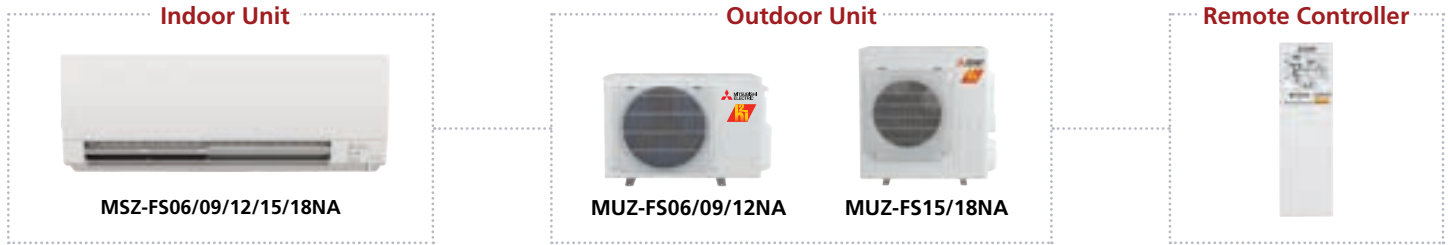

To confirm compatibility with the MXZ Model multi-zone system, refer to MXZ Model page.

Indoor Unit			MSZ-FS06NA	MSZ-FS09NA	MSZ-FS12NA	MSZ-FS15NA	MSZ-FS18NA	
Outdoor Unit			MUZ-FS06NA	MUZ-FS09NA	MUZ-FS12NA	MUZ-FS15NA	MUZ-FS18NA	
AHRI Certified Reference Number			209832199	209832201	209832203	209832205	209832207	
Cooling	Capacity	Rated 1	BTU/H	6,000	9,000	12,000	14,000	17,200
	Capacity Range	Min-Max	BTU/H	1,700-9,000	1,700-12,000	2,500-13,600	6,450-19,000	6,450-21,000
	Power Input	Rated 1	W	315	560	870	1,000	1,375
	Moisture Removal	Pints/h		0.2	0.6	1.9	4.0	4.8
	Sensible Heat Factor			0.960	0.920	0.830	0.700	0.690
Sensible Heat Factor - High Latent			—	—	—	—	—	
Heating	Capacity at 47°F	Rated 2	BTU/H	8,700	9,600	12,300	16,000	19,000
	Capacity Range	Min-Max	BTU/H	1,600-14,000	1,600-18,000	3,700-21,000	5,150-24,000	5,150-30,000
	Power Input at 47°F	Rated 2	W	545	620	850	1,155	1,610
	Capacity at 17°F	Rated 3	BTU/H	5,900	5,900	8,400	10,000	12,800
	Capacity at 5°F	Max 4	BTU/H	10,500	11,590	14,690	19,360	23,000
Capacity at -5°F	Max 5	BTU/H	8,700	9,600	12,300	16,000	19,000	
Efficiency	SEER2			32.2	29.8	26.3	21.0	21.0
	EER2			19.05	16.05	13.8	14.0	12.5
	HSPF2			11.9	10.9	11.1	10.4	10.7
	COP			4.68	4.54	4.24	4.06	3.46
Indoor Unit	Air Flow Rate - Cooling	Dry	CFM	137-167-221-304-381	137-167-221-304-381	137-167-221-304-424	225-262-304-355-437	225-262-304-355-437
	(Quiet-Lo-Med-High-SHigh)	Wet	CFM	117-143-190-261-328	117-143-190-261-328	117-143-190-261-364	194-225-261-305-376	194-225-261-305-376
	Air Flow Rate - Heating	Dry	CFM	140-167-225-325-437	140-167-225-325-437	155-226-282-367-454	201-272-350-410-514	201-272-350-410-514
	(Quiet-Lo-Med-High-SHigh)	Cooling	dB(A)	20-23-29-36-40	20-23-29-36-40	21-24-29-36-44	27-31-35-39-44	27-31-35-39-44
	Sound Pressure Level	Heating	dB(A)	20-24-29-39-42	20-24-29-39-42	21-28-32-38-43	25-31-37-40-46	25-31-37-40-46
	External Static Pressure		In. W.G.	—	—	—	—	—
	Condensate Lift Mechanism	Max Distance	In. [mm]	—	—	—	—	—
	Dimensions	H	In. [mm]	12 (+11/16) [305 (+17)]	12 (+11/16) [305 (+17)]	12 (+11/16) [305 (+17)]	12 (+11/16) [305 (+17)]	12 (+11/16) [305 (+17)]
		W	In. [mm]	36-7/16 [925]	36-7/16 [925]	36-7/16 [925]	36-7/16 [925]	36-7/16 [925]
		D	In. [mm]	9-3/16 [234]	9-3/16 [234]	9-3/16 [234]	9-3/16 [234]	9-3/16 [234]
Weight	lbs [kg]		29 [13.5]	29 [13.5]	29 [13.5]	29 [13.5]	29 [13.5]	
Outdoor Unit	MCA	A		10.0	10.0	10.0	18.0	18.0
	MOCP	A		15	15	15	20	20
	Dimensions	H	In. [mm]	21-5/8 [550]	21-5/8 [550]	21-5/8 [550]	34-5/8 [880]	34-5/8 [880]
		W	In. [mm]	31-1/2 [800]	31-1/2 [800]	31-1/2 [800]	33-1/16 [840]	33-1/16 [840]
		D	In. [mm]	11-1/4 [285]	11-1/4 [285]	11-1/4 [285]	13 [330]	13 [330]
	Weight	lbs [kg]		82 [37]	82 [37]	83 [37.5]	117 [53]	118 [53.5]
	Air Flow Rate (Cooling/Heating)	CFM		1141/1183	1141/1183	1215/1201	1801/1949	1801/1949
Sound Pressure Level	Cooling	dB(A)	47	48	49	51	52	
	Heating	dB(A)	49	49	51	55	55	
Piping	Diameter	Gas (O.D.)	In. [mm]	3/8 [9.52]	3/8 [9.52]	3/8 [9.52]	1/2 [12.7]	1/2 [12.7]
		Liquid (O.D.)	In. [mm]	1/4 [6.35]	1/4 [6.35]	1/4 [6.35]	1/4 [6.35]	1/4 [6.35]
		Indoor Drain	In. [mm]	5/8 [15.88]	5/8 [15.88]	5/8 [15.88]	5/8 [15.88]	5/8 [15.88]
	Max. Length	ft [m]		65 [20]	65 [20]	65 [20]	100 [30]	100 [30]
Max. Height	ft [m]		40 [12]	40 [12]	40 [12]	50 [15]	50 [15]	
Electrical	Outdoor-Indoor 6	V, ph, Hz		208/230, 1, 60	208/230, 1, 60	208/230, 1, 60	208/230, 1, 60	208/230, 1, 60
	Recommended Breaker Size	A		15	15	15	20	20
Refrigerant Type			R410A					
Guaranteed Temperature Operation Range	Cooling 7	°F DB [°C DB]		14 to 115	14 to 115	14 to 115	14 to 115	14 to 115
	Heating	°F DB [°C DB]		-13 to 75 [-25.0 to -4.0]	-13 to 75 [-25.0 to -4.0]	-13 to 75 [-25.0 to -4.0]	-13 to 75 [-25.0 to -4.0]	-13 to 75 [-25.0 to -4.0]

Notes:
 AHRI Rated Conditions (Rated data is determined at a fixed compressor speed)
 °Cooling (Indoor // Outdoor) °F 80 DB, 67 WB // 95 DB, 75 WB
 °Heating at 47°F (Indoor // Outdoor) °F 70 DB, 60 WB // 47 DB, 43 WB
 °Heating at 17°F (Indoor // Outdoor) °F 70 DB, 60 WB // 17 DB, 15 WB
 °Heating at 5°F (Indoor // Outdoor) °F 70 DB, 60 WB // 5 DB, 4 WB
 °Heating at -5°F (Indoor // Outdoor) °F 70 DB, 60 WB // -5 DB, -6 WB

Conditions
 6Indoor units receive power from outdoor units through field-supplied interconnected wiring.
 7Applications should be restricted to comfort cooling only; equipment cooling applications are not recommended for low ambient temperature conditions.

MSZ-FS (NAH) Specifications

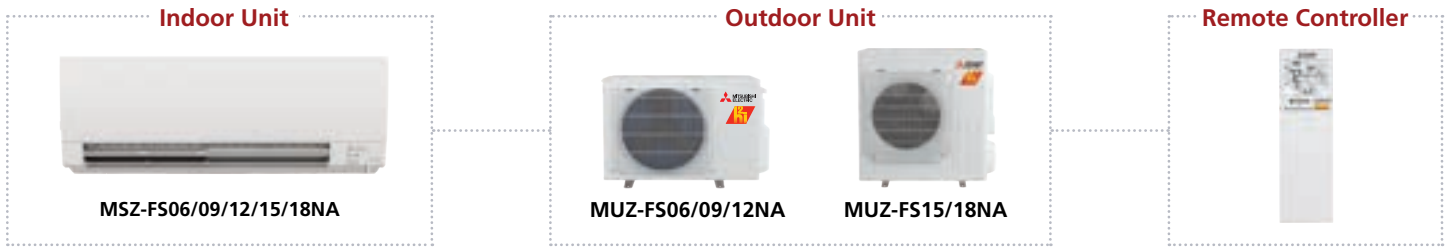

To confirm compatibility with the MXZ Model multi-zone system, refer to MXZ Model page.

Indoor Unit			MSZ-FS06NA	MSZ-FS09NA	MSZ-FS12NA	MSZ-FS15NA	MSZ-FS18NA	
Outdoor Unit			MUZ-FS06NAH	MUZ-FS09NAH	MUZ-FS12NAH	MUZ-FS15NAH	MUZ-FS18NAH	
AHRI Certified Reference Number			209832200	209832202	209832204	209832206	209832208	
Cooling	Capacity	Rated ¹	BTU/H	6,000	9,000	12,000	14,000	17,200
	Capacity Range	Min-Max	BTU/H	1,700-9,000	1,700-12,000	2,500-13,600	6,450-19,000	6,450-21,000
	Power Input	Rated ¹	W	315	560	870	1,000	1,375
	Moisture Removal	Pints/h		0.2	0.6	1.9	4.0	4.8
	Sensible Heat Factor			0.960	0.920	0.830	0.700	0.690
Sensible Heat Factor - High Latent			—	—	—	—	—	
Heating	Capacity at 47°F	Rated ²	BTU/H	8,700	9,600	12,300	16,000	19,000
	Capacity Range	Min-Max	BTU/H	1,600-14,000	1,600-18,000	3,700-21,000	5,150-24,000	5,150-30,000
	Power Input at 47°F	Rated ²	W	545	620	850	1,155	1,610
	Capacity at 17°F	Rated ³	BTU/H	5,900	5,900	8,400	10,000	12,800
	Capacity at 5°F	Max ⁴	BTU/H	12,840	14,170	17,410	22,730	27,000
Capacity at -5°F	Max ⁴	BTU/H	10,500	11,590	14,690	19,360	23,000	
Efficiency	SEER2			32.2	29.8	26.3	21.0	21.0
	EER2			19.05	16.05	13.8	14.0	12.5
	HSPF2			10.9	10.0	10.4	9.9	9.9
	COP			4.68	4.54	4.24	4.06	3.46
Indoor Unit	Air Flow Rate - Cooling	Dry	CFM	137-167-221-304-381	137-167-221-304-381	137-167-221-304-424	225-262-304-355-437	225-262-304-355-437
		Wet	CFM	117-143-190-261-328	117-143-190-261-328	117-143-190-261-364	194-225-261-305-376	194-225-261-305-376
	Air Flow Rate - Heating	Dry	CFM	140-167-225-325-437	140-167-225-325-437	155-226-282-367-454	201-272-350-410-514	201-272-350-410-514
	Sound Pressure Level	Cooling	dB(A)	20-23-29-36-40	20-23-29-36-40	21-24-29-36-44	27-31-35-39-44	27-31-35-39-44
		Heating	dB(A)	20-24-29-39-42	20-24-29-39-42	21-28-32-38-43	25-31-37-40-46	25-31-37-40-46
	External Static Pressure		In. W.G.	—	—	—	—	—
	Condensate Lift Mechanism	Max Distance	In. [mm]	—	—	—	—	—
	Dimensions	H	In. [mm]	12 (+11/16) [305 (+17)]	12 (+11/16) [305 (+17)]	12 (+11/16) [305 (+17)]	12 (+11/16) [305 (+17)]	12 (+11/16) [305 (+17)]
		W	In. [mm]	36-7/16 [925]	36-7/16 [925]	36-7/16 [925]	36-7/16 [925]	36-7/16 [925]
		D	In. [mm]	9-3/16 [234]	9-3/16 [234]	9-3/16 [234]	9-3/16 [234]	9-3/16 [234]
Weight	lbs [kg]		29 [13.5]	29 [13.5]	29 [13.5]	29 [13.5]	29 [13.5]	
Outdoor Unit	MCA	A		10.0	10.0	10.0	18.0	18.0
	MOCP	A		15	15	15	20	20
	Dimensions	H	In. [mm]	21-5/8 [550]	21-5/8 [550]	21-5/8 [550]	34-5/8 [880]	34-5/8 [880]
		W	In. [mm]	31-1/2 [800]	31-1/2 [800]	31-1/2 [800]	33-1/16 [840]	33-1/16 [840]
		D	In. [mm]	11-1/4 [285]	11-1/4 [285]	11-1/4 [285]	13 [330]	13 [330]
	Weight	lbs [kg]		83 [37.5]	83 [37.5]	84 [38]	118 [53.5]	118 [53.5]
Air Flow Rate (Cooling/Heating)	CFM		1141/1183	1141/1183	1215/1201	1801/1949	1801/1949	
Sound Pressure Level	Cooling	dB(A)	47	48	49	51	52	
	Heating	dB(A)	49	49	51	55	55	
Piping	Diameter	Gas (O.D.)	In. [mm]	3/8 [9.52]	3/8 [9.52]	3/8 [9.52]	1/2 [12.7]	1/2 [12.7]
		Liquid (O.D.)	In. [mm]	1/4 [6.35]	1/4 [6.35]	1/4 [6.35]	1/4 [6.35]	1/4 [6.35]
		Indoor Drain	In. [mm]	5/8 [15.88]	5/8 [15.88]	5/8 [15.88]	5/8 [15.88]	5/8 [15.88]
	Max. Length	ft [m]		65 [20]	65 [20]	65 [20]	100 [30]	100 [30]
Max. Height	ft [m]		40 [12]	40 [12]	40 [12]	50 [15]	50 [15]	
Electrical	Outdoor-Indoor ⁶	V, ph, Hz		208/230, 1, 60	208/230, 1, 60	208/230, 1, 60	208/230, 1, 60	208/230, 1, 60
	Recommended Breaker Size	A		15	15	20	20	20
Refrigerant Type				R410A	R410A	R410A	R410A	R410A
Guaranteed Temperature Operation Range	Cooling ⁷	°F DB [°C DB]		14 to 115	14 to 115	14 to 115	14 to 115	14 to 115
	Heating	°F DB [°C DB]		-13 to 75 [-25.0 to -4.0]	-13 to 75 [-25.0 to -4.0]	-13 to 75 [-25.0 to -4.0]	-13 to 75 [-25.0 to -4.0]	-13 to 75 [-25.0 to -4.0]

Notes:

AHRI Rated Conditions (Rated data is determined at a fixed compressor speed)

¹Cooling (Indoor // Outdoor)

²Heating at 47°F (Indoor // Outdoor)

³Heating at 17°F (Indoor // Outdoor)

⁴Heating at 5°F (Indoor // Outdoor)

⁵Heating at -5°F (Indoor // Outdoor)

⁶F 80 DB, 67 WB // 95 DB, 75 WB

⁷F 70 DB, 60 WB // 47 DB, 43 WB

⁸F 70 DB, 60 WB // 17 DB, 15 WB

⁹F 70 DB, 60 WB // 5 DB, 4 WB

¹⁰F 70 DB, 60 WB // -5 DB, -6 WB

Conditions

¹¹Indoor units receive power from outdoor units through field-supplied interconnected wiring.

¹²Applications should be restricted to comfort cooling only; equipment cooling applications are not recommended for low ambient temperature conditions.

MSZ-EF

Wall-mounted Indoor Unit



Designer Series Indoor Unit

The MSZ-EF Designer Wall-mounted Indoor Units combine sophisticated technology and design. With clean lines and three finish options (glossy black, matte silver, or glossy white), this indoor unit complements various decor and style preferences.

Capacities: 9,000 to 18,000 BTU/H

Sound: As low as 21 dB(A)

ENERGY STAR®: Most systems



Sleek Design for Any Space

The stylish wall-mounted indoor units have elegant edges, expressing sophistication and quality. The EF Models come in three color options: matte silver, glossy black, or glossy white. The EF Model boasts a modern design coupled with advanced technology, providing low power consumption, quiet operation, and powerful performance, making these units a smart selection.



Nano Platinum Filter

The Nano Platinum Filter generates stable antibacterial and deodorizing effects. The three-dimensional surface enlarges the filter capture area and increases dust collection performance compared to conventional filters.

MSZ-EF Specifications

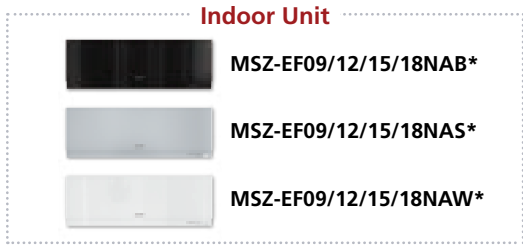

Color Options Available:
Matte Silver, Glossy Black, or Glossy White

For MXZ Connection Only*
Soft-dry cloth is enclosed with black models



Indoor Unit				MSZ-EF09NA(B/W/S)	MSZ-EF12NA(B/W/S)	MSZ-EF15NA(B/W/S)	MSZ-EF18NA(B/W/S)	
Cooling	Capacity	Rated ¹	BTU/H	—	—	—	—	
	Capacity Range	Min-Max	BTU/H	—	—	—	—	
	Power Input	Rated ¹	W	—	—	—	—	
	Moisture Removal	Pints/h		—	—	—	—	
	Sensible Heat Factor			—	—	—	—	
	Sensible Heat Factor - High Latent			—	—	—	—	
Heating	Capacity at 47°F	Rated ²	BTU/H	—	—	—	—	
	Capacity Range	Min-Max	BTU/H	—	—	—	—	
	Power Input at 47°F	Rated ²	W	—	—	—	—	
	Capacity at 17°F	Rated ³	BTU/H	—	—	—	—	
		Max	BTU/H	—	—	—	—	
	Capacity at 5°F	Max ⁴	BTU/H	—	—	—	—	
Efficiency	SEER2			—	—	—	—	
	EER2			—	—	—	—	
	HSPF2			—	—	—	—	
	COP			—	—	—	—	
Indoor Unit	Air Flow Rate - Cooling (Quiet-Lo-Med-High-SHigh)	Dry	CFM	141-162-222-293-371	141-162-222-293-371	205-233-272-314-364	205-240-279-328-388	
		Wet	CFM	121-140-191-252-319	121-140-191-252-319	176-200-234-270-313	176-206-240-282-334	
	Air Flow Rate - Heating (Quiet-Lo-Med-High-SHigh)	Dry	CFM	141-162-219-314-420	141-162-219-314-448	194-222-275-350-448	226-258-318-392-466	
		Cooling	dB(A)	21-23-29-36-42	21-24-29-36-42	28-31-35-39-42	30-33-36-40-43	
	Sound Pressure Level (Quiet-Lo-Med-High-SHigh)	Heating	dB(A)	21-24-29-37-45	21-24-30-38-46	28-30-35-41-48	30-33-37-43-49	
		External Static Pressure		In. W.G.	—	—	—	—
	Condensate Lift Mechanism	Max Distance	In. [mm]		—	—	—	—
			H	In. [mm]	11-3/4 [299]	11-3/4 [299]	11-3/4 [299]	11-3/4 [299]
	Dimensions	W	In. [mm]		34-13/16 [884]	34-13/16 [884]	34-13/16 [884]	34-13/16 [884]
		D	In. [mm]		7-11/16 [195]	7-11/16 [195]	7-11/16 [195]	7-11/16 [195]
Weight		lbs [kg]		26 [11.8]	26 [11.8]	26 [11.8]	26 [11.8]	
Outdoor Unit	MCA	A		—	—	—	—	
	MOCP	A		—	—	—	—	
	Dimensions	H	In. [mm]		—	—	—	—
		W	In. [mm]		—	—	—	—
		D	In. [mm]		—	—	—	—
	Weight	lbs [kg]		—	—	—	—	
Air Flow Rate (Cooling/Heating)	CFM		—	—	—	—		
Sound Pressure Level	Cooling	dB(A)		—	—	—	—	
	Heating	dB(A)		—	—	—	—	
Piping	Diameter	Gas (O.D.)	In. [mm]	—	—	—	—	
		Liquid (O.D.)	In. [mm]	—	—	—	—	
		Indoor Drain	In. [mm]	5/8 [15.88]	5/8 [15.88]	5/8 [15.88]	5/8 [15.88]	
Max. Length	ft [m]		—	—	—	—		
Max. Height	ft [m]		—	—	—	—		
Electrical	Outdoor-Indoor ⁶	V, ph, Hz		—	—	—	—	
	Recommended Breaker Size	A		—	—	—	—	
Refrigerant Type				—	—	—	—	
Guaranteed Temperature Operation Range	Cooling ⁷	°F DB [°C DB]		—	—	—	—	
	Heating	°F DB [°C DB]		—	—	—	—	

Notes:
 AHRI Rated Conditions (Rated data is determined at a fixed compressor speed)
¹Cooling (Indoor // Outdoor) °F 80 DB, 67 WB // 95 DB, 75 WB
²Heating at 47°F (Indoor // Outdoor) °F 70 DB, 60 WB // 47 DB, 43 WB
³Heating at 17°F (Indoor // Outdoor) °F 70 DB, 60 WB // 17 DB, 15 WB
⁴Heating at 5°F (Indoor // Outdoor) °F 70 DB, 60 WB // 5 DB, 4 WB
⁵Heating at -5°F (Indoor // Outdoor) °F 70 DB, 60 WB // -5 DB, -6 WB
 Conditions
⁶Indoor units receive power from outdoor units through field-supplied interconnected wiring.
⁷Applications should be restricted to comfort cooling only; equipment cooling applications are not recommended for low ambient temperature conditions.

MSY/Z-GS

Wall-mounted Indoor Unit



Premier Indoor Unit

The MSY/Z-GS Wall-mounted Indoor Unit offers a wide range of sizes, providing the most application solutions. The MSZ-GS indoor unit matches the single-zone heat pump, multi-zone heat pump, or H2i® Hyper-Heating INVERTER® heat pump systems. Its counterpart, the MSY-GS, is a single-zone air conditioner for climates where heating is unnecessary.

Capacities: 6,000 to 24,000 BTU/H

Sound: As low as 19 dB(A)

SEER2: Up to 24.30

HSPF2: Up to 10.90

COP: Up to 4.44

ENERGY STAR®: Most systems

Extensive Capacity Range

The MSY/Z-GS wall-mounted indoor units offer our highest design flexibility. Combinations include single-zone (cooling only or heat pump) and multi-zone (heat pump or hyper-heating heat pump) systems, a large selection of size ranges from 6,000 to 36,000 BTU/H.

Powerful Operation

Depending on the capacity, the unit will automatically adjust the fan speed and set temperature for 15 minutes. Rapid cooling and heating will make the room comfortable quickly.

GS24, GS30/36 Models Only

MSY/Z-GS Specifications



Indoor Unit			MSY-GS09NA	MSY-GS12NA	MSY-GS15NA	MSY-GS18NA	MSY-GS24NA	MSY-GS30NA	MSY-GS36NA	
Outdoor Unit			MUY-GS09NA	MUY-GS12NA	MUY-GS15NA	MUY-GS18NA	MUY-GS24NA	MUY-GS30NA	MUY-GS36NA	
AHRI Certified Reference Number			207679237	207679238	207679239	207679240	207679241	206422453	206422440	
Cooling	Capacity	Rated ¹	BTU/H	9,000	12,000	14,000	18,000	22,400	30,600	33,200
	Capacity Range	Min-Max	BTU/H	3,600–12,200	1,500–13,600	3,100–18,200	5,800–22,000	8,200–31,400	10,300–30,700	10,300–33,200
	Power Input	Rated ¹	W	585	920	1,100	1,340	1,780	3,320	3,770
	Moisture Removal	Pints/h		0.8	2.5	2.5	3.8	5.1	7.8	9.3
	Sensible Heat Factor			0.900	0.800	0.800	0.800	0.800	0.720	0.690
Sensible Heat Factor - High Latent				—	—	—	—	—	—	—
Heating	Capacity at 47°F	Rated ²	BTU/H	—	—	—	—	—	—	—
	Capacity Range	Min-Max	BTU/H	—	—	—	—	—	—	—
	Power Input at 47°F	Rated ²	W	—	—	—	—	—	—	—
	Capacity at 17°F	Rated ³	BTU/H	—	—	—	—	—	—	—
	Capacity at 5°F	Max ⁴	BTU/H	—	—	—	—	—	—	—
Capacity at -5°F	Max ⁵	BTU/H	—	—	—	—	—	—	—	
Efficiency	SEER2			28.4	25.6	21.0	21.5	21.5	19.2	18.5
	EER2			15.4	13.05	12.75	13.45	12.6	9.2	8.8
	HSPF2			—	—	—	—	—	—	—
	COP			—	—	—	—	—	—	—
Indoor Unit	Air Flow Rate - Cooling (Quiet-Lo-Med-High-SHigh)	Dry	CFM	134–160–222–307–381	134–160–222–307–381	1291–253–316–400–504	250–325–407–511–629	361–456–565–701	374–602–699–915	374–602–699–915
		Wet	CFM	121–144–200–276–343	121–144–200–276–343	172–228–285–360–454	225–292–367–460–566	325–410–509–631	374–602–699–915	374–602–699–915
	Air Flow Rate - Heating (Quiet-Lo-Med-High-SHigh)	Dry	CFM	—	—	—	—	—	—	—
					—	—	—	—	—	—
	Sound Pressure Level (Quiet-Lo-Med-High-SHigh)	Cooling	dB(A)	19–22–30–37–43	19–22–30–37–45	26–32–38–44–49	28–33–38–44–49	34–41–47–53	32–42–49–53	32–42–49–53
		Heating	dB(A)	—	—	—	—	—	—	—
	External Static Pressure		In. W.G.	—	—	—	—	—	—	—
	Condensate Lift Mechanism	Max Distance	In. [mm]	—	—	—	—	—	—	—
					—	—	—	—	—	—
	Dimensions	H	In. [mm]	11-5/8 [295]	11-5/8 [295]	11-5/8 [295]	12 [305]	12-13/16 [325]	14-3/8 [365]	14-3/8 [365]
W		In. [mm]	31-7/16 [798]	31-7/16 [798]	31-7/16 [798]	36-5/16 [923]	43-5/16 [1100]	46-1/16 [1170]	46-1/16 [1170]	
D		In. [mm]	9-1/8 [232]	9-1/8 [232]	9-1/8 [232]	9-13/16 [250]	9-3/8 [238]	11-5/8 [295]	11-5/8 [295]	
Weight	lbs [kg]		23 [10.4]	23 [10.4]	23 [10.4]	28 [12.4]	37 [16.4]	45 [20]	45 [20]	
Outdoor Unit	MCA	A		10.0	10.0	10.0	12.0	18.0	19.0	19.0
	MOCP	A		15	15	15	15	20	20	20
	Dimensions	H	In. [mm]	21-5/8 [550]	21-5/8 [550]	21-5/8 [550]	34-5/8 [880]	34-5/8 [880]	34-5/8 [880]	34-5/8 [880]
		W	In. [mm]	31-1/2 [800]	31-1/2 [800]	31-1/2 [800]	33-1/16 [840]	33-1/16 [840]	33-1/16 [840]	33-1/16 [840]
		D	In. [mm]	11-1/4 [285]	11-1/4 [285]	11-1/4 [285]	13 [330]	13 [330]	13 [330]	13 [330]
	Weight	lbs [kg]		79 [35.8]	79 [35.8]	84 [37.8]	119 [53.7]	118 [53.4]	121 [55.0]	121 [55.0]
	Air Flow Rate (Cooling/Heating)	CFM		—/—	—/—	—/—	—/—	—/—	1974/—	2191/—
	Sound Pressure Level	Cooling	dB(A)	48	49	49	54	55	55	56
		Heating	dB(A)	—	—	—	—	—	—	—
	Piping	Diameter	Gas (O.D.)	In. [mm]	3/8 [9.52]	3/8 [9.52]	1/2 [12.7]	1/2 [12.7]	5/8 [15.88]	5/8 [15.88]
Liquid (O.D.)			In. [mm]	1/4 [6.35]	1/4 [6.35]	1/4 [6.35]	1/4 [6.35]	1/4 [6.35]	1/4 [6.35]	1/4 [6.35]
Indoor Drain		In. [mm]	5/8 [15.88]	5/8 [15.88]	5/8 [15.88]	5/8 [15.88]	5/8 [15.88]	5/8 [15.88]	5/8 [15.88]	
Max. Length		ft [m]		65 [20]	65 [20]	65 [20]	100 [30]	100 [30]	100 [30]	100 [30]
Max. Height	ft [m]		40 [12]	40 [12]	40 [12]	50 [15]	50 [15]	50 [15]	50 [15]	
Electrical	Outdoor-Indoor ⁵	V, ph, Hz		208/230, 1, 60	208/230, 1, 60	208/230, 1, 60	208/230, 1, 60	208/230, 1, 60	208/230, 1, 60	208/230, 1, 60
	Recommended Breaker Size	A		15	15	15	15	20	20	20
Refrigerant Type				R410A	R410A	R410A	R410A	R410A	R410A	R410A
Guaranteed Temperature Operation Range	Cooling ⁶	°F DB [°C DB]		14 to 115	14 to 115	14 to 115	14 to 115	14 to 115	14 to 115 [-10.0 to 46.0]	14 to 115 [-10.0 to 46.0]
	Heating	°F DB [°C DB]		—	—	—	—	—	—	—

Notes:
 AHRI Rated Conditions ¹Cooling (Indoor // Outdoor) ²80 DB, 67 WB // 95 DB, 75 WB
 (Rated data is determined at a fixed compressor speed)
³Indoor units receive power from outdoor units through field-supplied interconnected wiring.
⁴Applications should be restricted to comfort cooling only; equipment cooling applications are not recommended for low ambient temperature conditions.

MSY/Z-GS Specifications

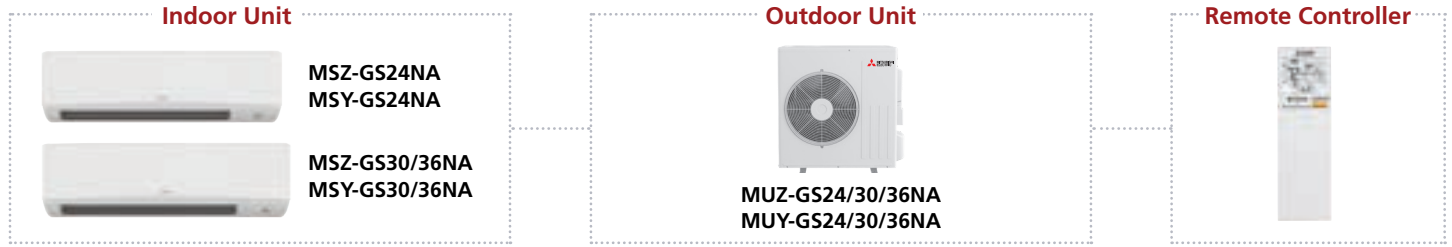

Indoor Unit			MSZ-GS06NA	MSZ-GS09NA	MSZ-GS12NA	MSZ-GS15NA	MSZ-GS18NA	MSZ-GS24NA	MSZ-GS30NA	MSZ-GS36NA		
Outdoor Unit				MUZ-GS09NA	MUZ-GS12NA	MUZ-GS15NA	MUZ-GS18NA	MUZ-GS24NA	MUZ-GS30NA	MUZ-GS36NA		
				207679242	207679243	207679244	207679245	207679246	206422454	206422455		
Cooling	Capacity	Rated ¹	BTU/H	—	9,000	12,000	14,000	18,000	22,400	30,600	33,200	
	Capacity Range	Min-Max	BTU/H	—	3,600–12,200	1,500–13,600	3,100–18,200	5,800–22,000	8,200–31,400	10,300–30,700	10,300–33,200	
	Power Input	Rated ¹	W	—	585	920	1,100	1,340	1,780	3,320	3,770	
	Moisture Removal		Pints/h	—	0.8	2.5	2.5	3.8	5.1	7.8	9.3	
	Sensible Heat Factor			—	0.900	0.800	0.800	0.800	0.800	0.720	0.690	
	Sensible Heat Factor - High Latent			—	—	—	—	—	—	—	—	
Heating	Capacity at 47°F	Rated ²	BTU/H	—	10,900	14,400	18,000	21,600	27,600	32,600	35,200	
	Capacity Range	Min-Max	BTU/H	—	4,500–15,900	2,000–18,100	4,800–20,900	5,400–25,000	7,500–36,900	9,800–34,000	9,800–36,000	
	Power Input at 47°F	Rated ²	W	—	720	1,100	1,600	1,680	2,340	3,340	3,740	
	Capacity at 17°F	Rated ³	BTU/H	—	6,500	9,000	12,100	13,300	17,600	21,000	22,400	
	Capacity at 5°F	Max ⁴	BTU/H	—	10,200	12,000	16,400	18,200	24,600	20,800	22,800	
	Capacity at -5°F	Max ⁵	BTU/H	—	7,900	9,540	14,400	14,780	19,640	18,800	20,500	
Efficiency	SEER2			—	28.4	25.6	21.0	21.5	21.5	—	—	
	EER2			—	15.4	13.05	12.75	13.45	12.6	—	—	
	HSPF2			—	10.9	10.7	11.0	10.3	10.3	—	—	
	COP			—	4.44	3.84	3.3	3.77	3.46	2.86	2.76	
Indoor Unit	Air Flow Rate - Cooling (Quiet-Lo-Med-High-SHigh)	Dry	CFM	—	134–160–222–307–381	134–160–222–307–381	1291–253–316–400–504	250–325–407–511–629	361–456–565–701	374–602–699–915	374–602–699–915	
		Wet	CFM	—	121–144–200–276–343	121–144–200–276–343	172–228–285–360–454	225–292–367–460–566	325–410–509–631	374–602–699–915	374–602–699–915	
	Air Flow Rate - Heating (Quiet-Lo-Med-High-SHigh)	Dry	CFM	—	134–160–222–307–390	134–160–222–307–390	191–231–285–348–437	287–375–459–550–629	336–456–565–701	374–602–699–803	374–602–699–803	
		Cooling	dB(A)	—	19–22–30–37–43	19–22–30–37–45	26–32–38–44–49	28–33–38–44–49	34–41–47–53	32–42–49–53	32–42–49–53	
	Sound Pressure Level (Quiet-Lo-Med-High-SHigh)	Heating	dB(A)	—	19–22–30–37–43	19–22–30–37–43	26–30–35–40–46	28–34–39–43–48	32–41–47–52	34–42–49–50	34–42–49–50	
		External Static Pressure		In. W.G.	—	—	—	—	—	—	—	
	Condensate Lift Mechanism	Max Distance		In. [mm]	—	—	—	—	—	—	—	
	Dimensions	H		In. [mm]	11-5/8 [295]	11-5/8 [295]	11-5/8 [295]	11-5/8 [295]	12 [305]	12-13/16 [325]	14-3/8 [365]	14-3/8 [365]
		W		In. [mm]	31-7/16 [798]	31-7/16 [798]	31-7/16 [798]	31-7/16 [798]	36-5/16 [923]	43-5/16 [1100]	46-1/16 [1170]	46-1/16 [1170]
		D		In. [mm]	9-1/8 [232]	9-1/8 [232]	9-1/8 [232]	9-1/8 [232]	9-13/16 [250]	9-3/8 [238]	11-5/8 [295]	11-5/8 [295]
Weight		lbs [kg]		23 [10.4]	23 [10.4]	23 [10.4]	28 [12.4]	37 [16.4]	45 [20]	45 [20]		
Outdoor Unit	MCA		A	—	10.0	10.0	10.0	12.0	18.0	19.0	19.0	
	MOCP		A	—	15	15	15	15	20	20	20	
	Dimensions	H		In. [mm]	—	21-5/8 [550]	21-5/8 [550]	21-5/8 [550]	34-5/8 [880]	34-5/8 [880]	34-5/8 [880]	
		W		In. [mm]	—	31-1/2 [800]	31-1/2 [800]	31-1/2 [800]	33-1/16 [840]	33-1/16 [840]	33-1/16 [840]	
		D		In. [mm]	—	11-1/4 [285]	11-1/4 [285]	11-1/4 [285]	13 [330]	13 [330]	13 [330]	
	Weight		lbs [kg]	—	79 [35.8]	79 [35.8]	84 [37.8]	119 [53.7]	118 [53.4]	121 [55.0]	121 [55.0]	
	Air Flow Rate (Cooling/Heating)		CFM	—	—/—	—/—	—/—	—/—	—/—	1974/1950	2191/1950	
	Sound Pressure Level	Cooling		dB(A)	—	48	49	49	54	55	55	56
		Heating		dB(A)	—	50	51	51	55	55	57	57
	Piping	Diameter	Gas (O.D.)	In. [mm]	—	3/8 [9.52]	3/8 [9.52]	1/2 [12.7]	1/2 [12.7]	5/8 [15.88]	5/8 [15.88]	5/8 [15.88]
Liquid (O.D.)			In. [mm]	—	1/4 [6.35]	1/4 [6.35]	1/4 [6.35]	1/4 [6.35]	1/4 [6.35]	1/4 [6.35]	1/4 [6.35]	
Indoor Drain		In. [mm]	5/8 [15.88]	5/8 [15.88]	5/8 [15.88]	5/8 [15.88]	5/8 [15.88]	5/8 [15.88]	5/8 [15.88]	5/8 [15.88]		
Max. Length		ft [m]	—	65 [20]	65 [20]	65 [20]	100 [30]	100 [30]	100 [30]	100 [30]		
Max. Height		ft [m]	—	40 [12]	40 [12]	40 [12]	50 [15]	50 [15]	50 [15]	50 [15]		
Electrical	Outdoor-Indoor ⁶		V, ph, Hz	—	208/230, 1, 60	208/230, 1, 60	208/230, 1, 60	208/230, 1, 60	208/230, 1, 60	208/230, 1, 60	208/230, 1, 60	
	Recommended Breaker Size		A	—	15	15	15	15	20	20	20	
Refrigerant Type				—	R410A	R410A	R410A	R410A	R410A	R410A		
Guaranteed Temperature Operation Range	Cooling ⁷		°F DB [°C DB]	—	14 to 115	14 to 115	14 to 115	14 to 115	14 to 115	14 to 115	14 to 115	
	Heating		°F DB [°C DB]	—	-4 to 75	-4 to 75	-4 to 75	-4 to 75	-4 to 75	-4 to 75	-4 to 75	

Notes:
 AHRI Rated Conditions (Rated data is determined at a fixed compressor speed)
¹Cooling (Indoor // Outdoor) °F 80 DB, 67 WB // 95 DB, 75 WB
²Heating at 47°F (Indoor // Outdoor) °F 70 DB, 60 WB // 47 DB, 43 WB
³Heating at 17°F (Indoor // Outdoor) °F 70 DB, 60 WB // 17 DB, 15 WB
⁴Heating at 5°F (Indoor // Outdoor) °F 70 DB, 60 WB // 5 DB, 4 WB
⁵Heating at -5°F (Indoor // Outdoor) °F 70 DB, 60 WB // -5 DB, -6 WB

Conditions
⁶Indoor units receive power from outdoor units through field-supplied interconnected wiring.
⁷Applications should be restricted to comfort cooling only; equipment cooling applications are not recommended for low ambient temperature conditions.



MSZ-HM

Wall-mounted Indoor Unit

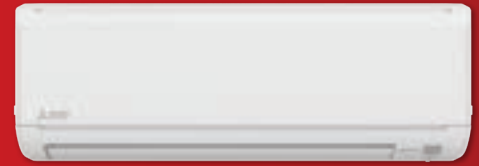

20 SEER Indoor Unit

The MSZ-HM 20 SEER Wall-mounted Indoor Unit pairs with a single-zone heat pump outdoor unit. The MSZ-HM features Econo Cool Energy Savings Mode intelligent temperature control and a stylish flat panel design.

Capacities: 9,000 to 24,000 BTU/H

Sound: As low as 22 dB(A)

SEER2: 20.00

HSPF2: 10.00

COP: Up to 3.61

ENERGY STAR®: Some systems



Blue Fin Heat Exchanger

Blue Fin is an anti-corrosion coating applied to the heat exchanger of the outdoor unit. This treatment prevents the deterioration of the aluminum fins caused by salt, especially in coastal areas. (Corrosion of the heat exchanger will affect the efficiency and performance of the outdoor unit.)



Anti-allergy Enzyme Air Filter

The base filter can remove dust particles from the air. The anti-allergy enzyme air filter traps allergens such as bacteria and decomposes them using enzymes retained in the filter. The anti-allergy enzyme filter is optional.

MSZ-HM Specifications

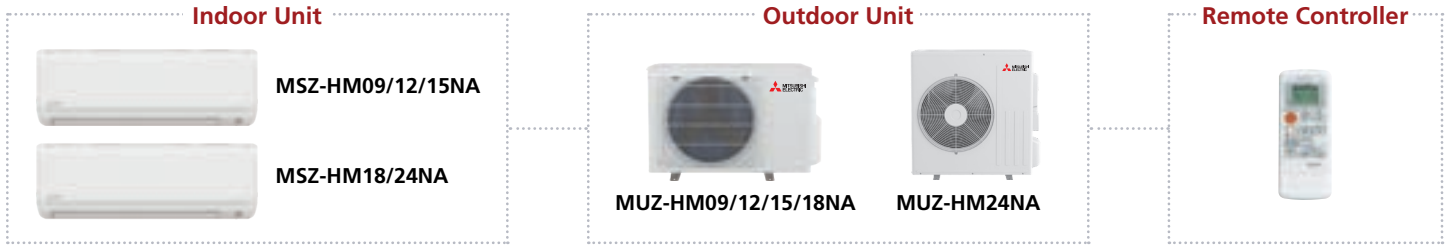

Indoor Unit			MSZ-HM09NA	MSZ-HM12NA	MSZ-HM15NA	MSZ-HM18NA	MSZ-HM24NA	
Outdoor Unit			MUZ-HM09NA	MUZ-HM12NA	MUZ-HM15NA	MUZ-HM18NA	MUZ-HM24NA	
AHRI Certified Reference Number			202680600	202680601	202680602	202680603	209832269	
Cooling	Capacity	Rated ¹	9,000	12,000	14,000	17,200	22,500	
	Capacity Range	Min-Max	3,800–10,000	3,800–12,200	3,100–16,000	5,800–18,000	5,800–22,500	
	Power Input	Rated ¹	750	1,210	1,170	1,640	2,630	
	Moisture Removal	Pints/h	1.5	2.5	2.7	2.1	2.3	
	Sensible Heat Factor		0.820	0.770	0.780	0.860	0.890	
	Sensible Heat Factor - High Latent		—	—	20	—	—	
Heating	Capacity at 47°F	Rated ²	10,900	12,200	18,000	18,000	26,000	
	Capacity Range	Min-Max	4,500–11,800	4,500–14,500	4,800–18,500	5,400–20,900	5,400–26,000	
	Power Input at 47°F	Rated ²	900	990	1,590	1,590	2,500	
	Capacity at 17°F	Rated ³	6,700	7,600	11,500	11,500	18,500	
		Max	7,200	900	14,000	15,000	18,500	
	Capacity at 5°F	Max ⁴	5,900	9,000	12,240	12,780	15,600	
	Max ⁵	—	—	—	—	—		
Efficiency	SEER2		Unavailable at print	12.0	20.0	19.0	20.0	
	EER2		Unavailable at print	10.5	12.0	10.5	8.6	
	HSPF2		Unavailable at print	8.6	10.0	9.5	8.5	
	COP		3.55	3.61	3.3	3.32	3.05	
Indoor Unit	Air Flow Rate - Cooling (Quiet-Lo-Med-High-SHigh)	Dry	CFM	170–237–321–399	170–237–321–399	272–335–420–533	328–431–530–625	353–431–530–702
		Wet	CFM	134–201–286–364	134–201–286–364	237–300–385–498	295–388–477–562	318–388–477–632
	Air Flow Rate - Heating (Quiet-Lo-Med-High-SHigh)	Dry	CFM	170–237–321–406	170–237–321–406	247–304–367–463	307–431–530–625	346–448–579–702
		Cooling	dB(A)	22–30–37–43	22–30–37–45	32–38–44–49	30–37–42–47	33–38–44–50
	Sound Pressure Level (Quiet-Lo-Med-High-SHigh)	Heating	dB(A)	22–30–37–43	22–30–37–43	30–35–40–46	30–37–42–47	32–38–44–50
		External Static Pressure	In. W.G.	—	—	—	—	—
	Dimensions	Condensate Lift Mechanism	Max Distance	In. [mm]	—	—	—	—
		H	In. [mm]	11-5/8 [295]	11-5/8 [295]	11-5/8 [295]	12 [305]	12 [305]
			W	In. [mm]	31-7/16 [798]	31-7/16 [798]	31-7/16 [798]	36-5/16 [923]
	D		In. [mm]	9-1/8 [232]	9-1/8 [232]	9-1/8 [232]	9-13/16 [250]	9-13/16 [250]
Weight	lbs [kg]	22 [10]	22 [10]	22 [10]	28 [13.0]	28 [13.0]		
MCA	A	9.0	9.0	10.0	10.0	14.0		
MOC	A	15	15	15	15	15		
Outdoor Unit	Dimensions	H	In. [mm]	21-5/8 [550]	21-5/8 [550]	21-5/8 [550]	21-5/8 [550]	34-5/8 [880]
		W	In. [mm]	31-1/2 [800]	31-1/2 [800]	31-1/2 [800]	31-1/2 [800]	33-1/16 [840]
		D	In. [mm]	11-1/4 [286]	11-1/4 [286]	11-1/4 [286]	11-1/4 [286]	13 [330]
	Weight	lbs [kg]	73 [33.1]	73 [33.1]	81 [36.7]	81 [36.7]	121 [55]	
Air Flow Rate (Cooling/Heating)		CFM	1151/1225	1151/1225	1243/1229	1243/1229	1691/1691	
Sound Pressure Level	Cooling	dB(A)	46	49	49	50	54	
	Heating	dB(A)	50	51	51	51	55	
Piping	Diameter	Gas (O.D.)	In. [mm]	3/8 [9.52]	3/8 [9.52]	1/2 [12.7]	1/2 [12.7]	5/8 [15.88]
		Liquid (O.D.)	In. [mm]	1/4 [6.35]	1/4 [6.35]	1/4 [6.35]	1/4 [6.35]	3/8 [9.52]
		Indoor Drain	In. [mm]	5/8 [15.88]	5/8 [15.88]	5/8 [15.88]	5/8 [15.88]	5/8 [15.88]
Max. Length	ft [m]	65 [20]	65 [20]	65 [20]	65 [20]	100 [30]		
Max. Height	ft [m]	40 [12]	40 [12]	40 [12]	40 [12]	50 [15]		
Electrical	Outdoor-Indoor ⁶	V, ph, Hz	208/230, 1, 60	208/230, 1, 60	208/230, 1, 60	208/230, 1, 60	208/230, 1, 60	
	Recommended Breaker Size	A	15	15	15	15	15	
Refrigerant Type			R410A	R410A	R410A	R410A	—	
Guaranteed Temperature Operation Range	Cooling ⁷	°F DB [°C DB]	14 to 115 [-10.0 to 46.0]	14 to 115 [-10.0 to 46.0]	14 to 115 [-10.0 to 46.0]	14 to 115 [-10.0 to 46.0]	14 to 115 [-10.0 to 46.0]	
	Heating	°F DB [°C DB]	-4 to 75 [-20.0 to 24.0]	-4 to 75 [-20.0 to 24.0]	-4 to 75 [-20.0 to 24.0]	-4 to 75 [-20.0 to 24.0]	-4 to 75 [-20.0 to 24.0]	

Notes:
 AHRI Rated Conditions ¹Cooling (Indoor // Outdoor) °F 80 DB, 67 WB // 95 DB, 75 WB
 (Rated data is determined at a fixed compressor speed) ²Heating at 47°F (Indoor // Outdoor) °F 70 DB, 60 WB // 47 DB, 43 WB
³Heating at 17°F (Indoor // Outdoor) °F 70 DB, 60 WB // 17 DB, 15 WB
⁴Heating at 5°F (Indoor // Outdoor) °F 70 DB, 60 WB // 5 DB, 4 WB
⁵Heating at -5°F (Indoor // Outdoor) °F 70 DB, 60 WB // -5 DB, -6 WB

Conditions
⁶Indoor units receive power from outdoor units through field-supplied interconnected wiring.
⁷Applications should be restricted to comfort cooling only; equipment cooling applications are not recommended for low ambient temperature conditions.

MSZ-JP

Wall-mounted Indoor Unit

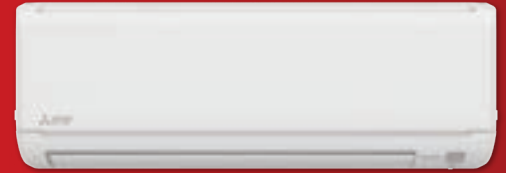

115V Indoor Unit

The MSZ-JP 115V Wall-mounted Indoor Unit pairs with a 115V single-zone heat pump outdoor unit. The MSZ-JP features Econo Cool Energy Savings Mode intelligent temperature control and a stylish flat panel design.

Capacities: 9,000 to 12,000 BTU/H

Sound: As low as 22 dB(A)

SEER2: 20.00

HSPF2: 10.00

COP: Up to 3.61

ENERGY STAR®: Some systems



Blue Fin Heat Exchanger

Blue Fin is an anti-corrosion coating applied to the heat exchanger of the outdoor unit. This treatment prevents the deterioration of the aluminum fins caused by salt, especially in coastal areas. (Corrosion of the heat exchanger will affect the efficiency and performance of the outdoor unit.)



Econo Cool Energy-saving Feature

Econo Cool is an intelligent temperature control feature that adjusts the amount of air discharged based on the air-outlet temperature. The temperature set point can be raised up to 4° without any loss in comfort, thereby realizing a 20% gain in energy efficiency. Function only available during manual cooling operation.

MSZ-JP Specifications



Indoor Unit				MSZ-JP09WA				MSZ-JP12WA			
Outdoor Unit				MUZ-JP09WA				MUZ-JP12WA			
AHRI Certified Reference Number				209832210				209832211			
Cooling	Capacity	Rated ¹	BTU/H	9,000				12,000			
	Capacity Range	Min-Max	BTU/H	3,800-10,000				3,800-12,000			
	Power Input	Rated ¹	W	750				1,210			
	Moisture Removal	Pints/h		1.5				2.5			
	Sensible Heat Factor			0.820				0.770			
Sensible Heat Factor - High Latent				—				—			
Heating	Capacity at 47°F	Rated ²	BTU/H	10,900				12,200			
	Capacity Range	Min-Max	BTU/H	4,500-11,800				4,500-14,500			
	Power Input at 47°F	Rated ²	W	900				990			
	Capacity at 17°F	Rated ³	BTU/H	6,700				7,600			
		Max	BTU/H	7,200				9,000			
	Capacity at 5°F	Max ⁴	BTU/H	5,990				7,440			
	Capacity at -5°F	Max ⁵	BTU/H	—				—			
Efficiency	SEER2			20.0				20.0			
	EER2			12.0				9.9			
	HSPF2			10.0				9.2			
	COP			3.55				3.61			
Indoor Unit	Air Flow Rate - Cooling (Quiet-Low-Med-High-SHigh)	Dry	CFM	170-237-321-399				170-237-321-399			
		Wet	CFM	134-201-286-364				134-201-286-364			
	Air Flow Rate - Heating (Quiet-Low-Med-High-SHigh)	Dry	CFM	170-237-321-406				170-237-321-406			
	Sound Pressure Level (Quiet-Low-Med-High-SHigh)	Cooling	dB(A)	22-30-37-43				22-30-37-43			
		Heating	dB(A)	22-30-37-43				22-30-37-43			
	External Static Pressure		In. W.G.	—				—			
	Condensate Lift Mechanism	Max Distance	In. [mm]	—				—			
	Dimensions	H	In. [mm]	11-5/8 [295]				11-5/8 [295]			
		W	In. [mm]	31-7/16 [798]				31-7/16 [798]			
		D	In. [mm]	9-1/8 [232]				9-1/8 [232]			
Weight	lbs [kg]		22 [10]				22 [10]				
Outdoor Unit	MCA	A		12.0				14.0			
	MOCP	A		15				15			
	Dimensions	H	In. [mm]	21-5/8 [550]				21-5/8 [550]			
		W	In. [mm]	31-1/2 [800]				31-1/2 [800]			
		D	In. [mm]	11-1/4 [285]				11-1/4 [285]			
	Weight	lbs [kg]		73 [33]				73 [33]			
	Air Flow Rate (Cooling/Heating)	CFM		1105/1225				1105/1225			
Sound Pressure Level	Cooling	dB(A)	46				49				
	Heating	dB(A)	46				50				
Piping	Diameter	Gas (O.D.)	In. [mm]	3/8 [9.52]				3/8 [9.52]			
		Liquid (O.D.)	In. [mm]	1/4 [6.35]				1/4 [6.35]			
		Indoor Drain	In. [mm]	5/8 [15.88]				5/8 [15.88]			
	Max. Length	ft [m]		65 [12]				65 [12]			
Max. Height	ft [m]		40 [20]				40 [20]				
Electrical	Outdoor-Indoor ⁶	V, ph, Hz		115, 1, 60				115, 1, 60			
	Recommended Breaker Size	A		15				15			
Refrigerant Type				R410A				R410A			
Guaranteed Temperature Operation Range	Cooling ⁷	°F DB [°C DB]		14 to 115 [-10.0 to 46.0]				14 to 115 [-10.0 to 46.0]			
	Heating	°F DB [°C DB]		-4 to 75 [-20.0 to 24.0]				-4 to 75 [-20.0 to 24.0]			

Notes:
 AHRI Rated Conditions (Rated data is determined at a fixed compressor speed)
¹Cooling (Indoor // Outdoor) °F 80 DB, 67 WB // 95 DB, 75 WB
²Heating at 47°F (Indoor // Outdoor) °F 70 DB, 60 WB // 47 DB, 43 WB
³Heating at 17°F (Indoor // Outdoor) °F 70 DB, 60 WB // 17 DB, 15 WB
⁴Heating at 5°F (Indoor // Outdoor) °F 70 DB, 60 WB // 5 DB, 4 WB
⁵Heating at -5°F (Indoor // Outdoor) °F 70 DB, 60 WB // -5 DB, -6 WB
 Conditions
⁶Indoor units receive power from outdoor units through field-supplied interconnected wiring.
⁷Applications should be restricted to comfort cooling only; equipment cooling applications are not recommended for low ambient temperature conditions.

MSZ-WR

Wall-mounted Indoor Unit

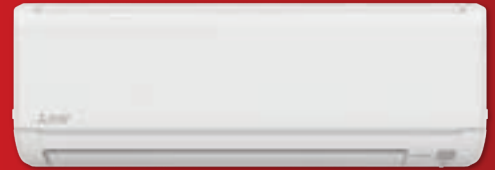

18 SEER Indoor Unit

The MSZ-WR 18 SEER Wall-mounted Indoor Unit pairs with a single-zone heat pump outdoor unit. The MSZ-WR features Econo Cool Energy Savings Mode intelligent temperature control and a stylish flat panel design.

Capacities: 9,000 to 24,000 BTU/H

Sound: As low as 22 dB(A)

SEER2: 18.00

HSPF2: 8.50

COP: Up to 3.28

ENERGY STAR®: No



Blue Fin Heat Exchanger

Blue Fin is an anti-corrosion coating applied to the heat exchanger of the outdoor unit. This treatment prevents the deterioration of the aluminum fins caused by salt, especially in coastal areas. (Corrosion of the heat exchanger will affect the efficiency and performance of the outdoor unit.)



Anti-allergy Enzyme Air Filter

The base filter can remove dust particles from the air. The anti-allergy enzyme air filter traps allergens such as bacteria and decomposes them using enzymes retained in the filter. The anti-allergy enzyme filter is optional.

MSZ-WR Specifications



Indoor Unit			MSZ-WR09NA	MSZ-WR12NA	MSZ-WR18NA	MSZ-WR24NA	
Outdoor Unit			MUZ-WR09NA-U2	MUZ-WR12NA-U2	MUZ-WR18NA-U2	MUZ-WR24NA	
AHRI Certified Reference Number			209832212		209832213		
Cooling	Capacity	Rated ¹	BTU/H	9,000	12,000	17,200	
	Capacity Range	Min-Max	BTU/H	3,800-10,000	3,800-12,200	5,800-18,000	
	Power Input	Rated ¹	W	820	1,330	2,810	
	Moisture Removal	Pints/h		1.5	2.5	2.3	
	Sensible Heat Factor			0.820	0.770	0.860	
	Sensible Heat Factor - High Latent			20	20	—	
Heating	Capacity at 47°F	Rated ²	BTU/H	10,900	12,200	18,000	
	Capacity Range	Min-Max	BTU/H	4,500-11,800	4,500-14,500	5,400-20,900	
	Power Input at 47°F	Rated ²	W	980	1,090	1,670	
	Capacity at 17°F	Rated ³	BTU/H	6,700	7,600	11,500	
		Max	BTU/H	7,200	9,000	15,000	
	Capacity at 5°F	Max ⁴	BTU/H	5,990	7,440	12,780	
Efficiency	SEER2			18.0	18.0	18.0	
	EER2			11.0	9.0	10.0	
	HSPF2			8.5	8.5	8.5	
	COP			3.25	3.28	3.16	
Indoor Unit	Air Flow Rate - Cooling (Quiet-Lo-Med-High-SHigh)	Dry	CFM	170-237-321-399	170-237-321-399	328-431-530-625	
		Wet	CFM	134-201-286-364	134-201-286-364	295-388-477-562	
	Air Flow Rate - Heating (Quiet-Lo-Med-High-SHigh)	Dry	CFM	170-237-321-406	170-237-321-406	307-431-530-625	
		Heating	dB(A)	22-30-37-43	22-30-37-45	30-37-42-47	
	Sound Pressure Level (Quiet-Lo-Med-High-SHigh)	Heating	dB(A)	22-30-37-43	22-30-37-43	30-37-42-47	
	External Static Pressure		In. W.G.	—	—	—	
	Dimensions	Condensate Lift Mechanism	Max Distance	In. [mm]	—	—	—
			H	In. [mm]	11-5/8 [295]	11-5/8 [295]	12 [305]
		W	In. [mm]	31-7/16 [798]	31-7/16 [798]	36-5/16 [923]	
			D	In. [mm]	9-1/8 [232]	9-1/8 [232]	9-13/16 [250]
Weight	lbs [kg]		22 [10]	22 [10]	28 [13]		
Outdoor Unit	MCA	A		9.0	10.0	9.0	
	MOC	A		15	15	15	
	Dimensions	H	In. [mm]	21-5/8 [550]	21-5/8 [550]	34-5/8 [880]	
		W	In. [mm]	31-1/2 [800]	31-1/2 [800]	31-1/16 [840]	
		D	In. [mm]	11-1/4 [286]	11-1/4 [286]	13 [330]	
	Weight	lbs [kg]		73 [33]	73 [33]	121 [55]	
	Air Flow Rate (Cooling/Heating)		CFM	1151/1225	1243/1229	1151/1225	
Sound Pressure Level	Cooling	dB(A)	51	53	48		
	Heating	dB(A)	51	51	50		
Piping	Diameter	Gas (O.D.)	In. [mm]	3/8 [9.52]	1/2 [12.7]	3/8 [9.52]	
		Liquid (O.D.)	In. [mm]	1/4 [6.35]	1/4 [6.35]	1/4 [6.35]	
		Indoor Drain	In. [mm]	5/8 [15.88]	5/8 [15.88]	5/8 [15.88]	
Max. Length	ft [m]		65 [12]	65 [12]	65 [12]		
Max. Height	ft [m]		40 [20]	40 [20]	40 [20]		
Electrical	Outdoor-Indoor ⁶	V, ph, Hz		208/230, 1, 60	208/230, 1, 60	208/230, 1, 60	
	Recommended Breaker Size	A		15	15	15	
Refrigerant Type			R410A		R410A		
Guaranteed Temperature Operation Range	Cooling ⁷	°F DB [°C DB]		32 to 115 [-10.0 to 46.0]	32 to 115 [-10.0 to 46.0]	32 to 115 [-10.0 to 46.0]	
	Heating	°F DB [°C DB]		5 to 75 [-20.0 to 24.0]	5 to 75 [-20.0 to 24.0]	5 to 75 [-20.0 to 24.0]	

Notes:
 AHRI Rated Conditions (Rated data is determined at a fixed compressor speed)
 Conditions
¹Cooling (Indoor // Outdoor) °F 80 DB, 67 WB // 95 DB, 75 WB
²Heating at 47°F (Indoor // Outdoor) °F 70 DB, 60 WB // 47 DB, 43 WB
³Heating at 17°F (Indoor // Outdoor) °F 70 DB, 60 WB // 17 DB, 15 WB
⁴Heating at 5°F (Indoor // Outdoor) °F 70 DB, 60 WB // 5 DB, 4 WB
⁵Heating at -5°F (Indoor // Outdoor) °F 70 DB, 60 WB // -5 DB, -6 WB

⁶Indoor units receive power from outdoor units through field-supplied interconnected wiring.
⁷Applications should be restricted to comfort cooling only; equipment cooling applications are not recommended for low ambient temperature conditions.

MFZ-KJ

Floor-mounted Indoor Unit



Floor-mounted Indoor Unit

The MFZ-KJ Floor-mounted Indoor Unit mounts low on the wall and can be mounted partially recessed. This indoor unit features rapid heating capability that quickly warms a space to the desired temperature and a multi-flow vane, distributing airflow throughout the room, preventing uneven temperatures.

Capacities: 9,000 to 18,000 BTU/H

Sound: As low as 21 dB(A)

SEER2: Up to 28.70

HSPF2: Up to 11.30

COP: Up to 4.30

ENERGY STAR®: Yes

Slim Design

The MFZ-KJ low on the wall and has a two-block structure that can accommodate a partially recessed installation. The base can be removed to accentuate the stylish main body.

Multi-flow Vane

Two air streams leave the unit. Part of the supply air discharges upward to heat the room while the other flows down across the floor. The air currents can be controlled freely.

MFZ-KJ Specifications



Indoor Unit				MFZ-KJ09NA	MFZ-KJ12NA	MFZ-KJ15NA	MFZ-KJ18NA
Outdoor Unit				MUZF-KJ09NAHZ	MUZF-KJ12NAHZ	MUZF-KJ15NAHZ	MUZF-KJ18NAHZ
AHRI Certified Reference Number				210819459	210819460	210819447	210819448
Cooling	Capacity	Rated ¹	BTU/H	9,000	12,000	15,000	17,000
	Capacity Range	Min-Max	BTU/H	2,300-14,000	2,300-15,000	5,300-19,000	5,300-22,500
	Power Input	Rated ¹	W	570	890	1,120	1,350
	Moisture Removal	Pints/h		1.4	2.7	3.9	4.4
	Sensible Heat Factor			0.790	0.700	0.660	0.650
	Sensible Heat Factor - High Latent			—	—	—	—
Heating	Capacity at 47°F	Rated ²	BTU/H	11,000	13,000	18,000	21,000
	Capacity Range	Min-Max	BTU/H	2,900-19,000	2,900-22,800	5,700-25,000	5,700-29,000
	Power Input at 47°F	Rated ²	W	750	900	1,410	1,730
	Capacity at 17°F	Rated ³	BTU/H	7,500	8,800	12,000	12,800
	Capacity at 5°F	Max ⁴	BTU/H	13,400	14,800	20,500	23,000
	Capacity at -5°F	Max ⁵	BTU/H	11,000	13,000	18,000	21,000
Efficiency	SEER2			28.7	26.7	22.2	22.0
	EER2			15.8	13.6	13.5	12.6
	HSPF2			11.3	10.6	10.7	10.3
	COP			4.3	4.2	3.7	3.5
Indoor Unit	Air Flow Rate - Cooling (Quiet-Lo-Med-High-SHigh)	Dry	CFM	138-198-272-360-417	138-198-272-360-417	198-254-311-392-431	198-254-328-420-491
		Wet	CFM	117-168-231-306-354	117-168-231-306-354	168-216-264-333-366	168-216-279-357-417
	Air Flow Rate - Heating (Quiet-Lo-Med-High-SHigh)	Dry	CFM	138-191-254-328-417	138-191-254-328-417	212-268-328-399-470	212-268-328-399-470
		Heating	dB(A)	21-27-34-41-46	21-27-34-41-46	28-33-38-43-47	28-33-39-45-50
	Sound Pressure Level (Quiet-Lo-Med-High-SHigh)	Cooling	dB(A)	21-27-34-41-46	21-27-34-41-46	28-33-38-43-47	28-33-39-45-50
		Heating	dB(A)	21-27-34-40-46	21-27-34-40-46	29-35-40-45-49	29-35-40-45-49
	External Static Pressure		In. W.G.	—	—	—	—
	Condensate Lift Mechanism	Max Distance	In. [mm]	—	—	—	—
			H	In. [mm]	23-5/8 [600]	23-5/8 [600]	23-5/8 [600]
		Dimensions	W	In. [mm]	29-17/32 [750]	29-17/32 [750]	29-17/32 [750]
D			In. [mm]	8-15/32 [215]	8-15/32 [215]	8-15/32 [215]	8-15/32 [215]
Weight		lbs [kg]	33 [15.0]	33 [15.0]	33 [15.0]	33 [15.0]	
Outdoor Unit	MCA	A		11.0	11.0	16.0	16.0
	MOC	A		15	15	20	20
	Dimensions	H	In. [mm]	21-5/8 [550]	21-5/8 [550]	34-5/8 [880]	34-5/8 [880]
		W	In. [mm]	31-1/2 [800]	31-1/2 [800]	33-1/16 [840]	33-1/16 [840]
		D	In. [mm]	11-1/4 [285]	11-1/4 [285]	13 [330]	13 [330]
	Weight		lbs [kg]	83 [38]	83 [38]	124 [56]	124 [56]
	Air Flow Rate (Cooling/Heating)		CFM	1074/1202	1074/1202	1653/1730	1653/1730
	Sound Pressure Level	Cooling	dB(A)	48	48	51	51
Heating		dB(A)	50	50	55	55	
Piping	Diameter	Gas (O.D.)	In. [mm]	3/8 [9.52]	3/8 [9.52]	1/2 [12.7]	1/2 [12.7]
		Liquid (O.D.)	In. [mm]	1/4 [6.35]	1/4 [6.35]	1/4 [6.35]	1/4 [6.35]
		Indoor Drain	In. [mm]	5/8 O.D [15]	5/8 O.D [15]	5/8 O.D [15]	5/8 O.D [15]
	Max. Length		ft [m]	65 [20]	65 [20]	100 [30]	100 [30]
Max. Height		ft [m]	40 [12]	40 [12]	50 [15]	50 [15]	
Electrical	Outdoor-Indoor ⁶	V, ph, Hz		208/230, 1, 60	208/230, 1, 60	208/230, 1, 60	208/230, 1, 60
	Recommended Breaker Size	A		15	15	20	20
Refrigerant Type				R410A	R410A	R410A	R410A
Guaranteed Temperature Operation Range	Cooling ⁷	°F DB [°C DB]		14 to 115 [-10.0 to 46.0]	14 to 115 [-10.0 to 46.0]	14 to 115 [-10.0 to 46.0]	14 to 115 [-10.0 to 46.0]
	Heating	°F DB [°C DB]		-13 to 75 [-25.0 to 24.0]	-13 to 75 [-25.0 to 24.0]	-13 to 75 [-25.0 to 24.0]	-13 to 75 [-25.0 to 24.0]

Notes:
 AHRI Rated Conditions (Rated data is determined at a fixed compressor speed)
¹Cooling (Indoor // Outdoor) °F 80 DB, 67 WB // 95 DB, 75 WB
²Heating at 47°F (Indoor // Outdoor) °F 70 DB, 60 WB // 47 DB, 43 WB
³Heating at 17°F (Indoor // Outdoor) °F 70 DB, 60 WB // 17 DB, 15 WB
⁴Heating at 5°F (Indoor // Outdoor) °F 70 DB, 60 WB // 5 DB, 4 WB
⁵Heating at -5°F (Indoor // Outdoor) °F 70 DB, 60 WB // -5 DB, -6 WB

Conditions
⁶Indoor units receive power from outdoor units through field-supplied interconnected wiring.
⁷Applications should be restricted to comfort cooling only; equipment cooling applications are not recommended for low ambient temperature conditions.

SUZ Models

Universal Outdoor Unit



Universal Heat Pump

The SUZ Universal Heat Pump is an outdoor unit compatible with five different indoor unit types in a 1-to-1 configuration. This high-efficiency heat pump is compatible with MLZ EZ FIT Ceiling Cassettes, SLZ Four-way Ceiling Cassettes, SVZ Multi-position Air Handlers, SEZ Low Static intelli-AIR™ Ducted Solutions, and PEAD Mid Static intelli-AIR™ Ducted Solutions.

Capacities: 9,000 to 36,000 BTU/H

Sound: As low as 48 dB(A)

SEER2: Up to 24.00

HSPF2: Up to 11.90

COP: Up to 3.90

ENERGY STAR®: Most systems



Powerful Compressor

Manufacturing with the Heat Caulking Fixing Method reduces compressor size while maintaining a high compressor output. This technology enables the installation of a more powerful compressor in compact outdoor units. As a result, it is possible to achieve excellent heating performance while operating in cold outdoor environments.



Hyper-heating INVERTER®

The H2i® models provide heating even when it's -13° F (-25° C) outdoors, producing up to 100% heating capacity at 5° F (-15° C). These units offer year-round comfort even in extreme climates.

System Compatibility

Hyper-heating Heat Pumps



SUZ-KA09/12/15/18NAHZ



SUZ-KA24NAHZ

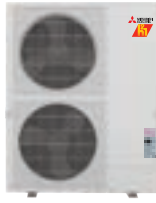

SUZ-KA30/36NAHZ

Standard Heat Pump



SUZ-KA09/12/15NA2



SUZ-KA18/24/30/36NA2

Compatible Indoor Units



EZ FIT®
Recessed
Ceiling Cassette



SLZ-KF
Two-way
Ceiling Cassette



SEZ-KD
Low-static
Ducted Unit



PEAD
Mid-static
Ducted Unit



SVZ
Multi-position
Air Handler

Unit Compatibility

Outdoor Unit Capacity BTU/H		9		12		15		18		24		30		36	
Model	Type	HP		HP		HP		HP		HP		HP		HP	
SLZ-KF	Two-way Cassette	•	•	•	•	•	•	•	•						
SEZ-KD	Low-static Ducted	•	•	•	•	•	•	•	•						
PEAD	Mid-static Ducted	•	•	•	•	•	•	•	•	•	•	•	•	•	•
SVZ	Multi-position Air Handler			•	•			•	•	•	•	•	•	•	•
MLZ-KP	EZ FIT® Recessed Ceiling Cassette	•	•	•	•			•	•						

Available capacities in BTU/H: 9, 12, 15, 18, 24, 30, 36. Single-zone outdoor unit matches multiple indoor unit options Heat Pump or Hyper-Heating INVERTER®

Heating Performance at Low Temperatures

SUZ-KA09NAHZ

COP at	SLZ	SEZ	PEAD	MLZ
47° F	3.90	2.80	3.80	4.10
17° F	2.56	2.20	2.56	2.76
5° F	1.34	1.59	1.67	1.67

SUZ-KA18NAHZ

COP at	SLZ	SEZ	PEAD	SVZ	MLZ
47° F	3.40	3.90	3.30	3.30	3.00
17° F	2.10	2.00	2.49	2.32	2.42
5° F	1.75	1.75	1.66	1.75	1.39

SUZ-KA30NAHZ

COP at	PEAD	SVZ
47° F	3.40	3.90
17° F	2.10	2.0
5° F	1.75	1.75

SUZ-KA09NAHZ

COP at	SLZ	SEZ	PEAD	SVZ	MLZ
47° F	3.40	3.90	3.90	3.80	3.80
17° F	2.38	2.56	2.72	2.61	2.54
5° F	1.83	2.19	2.09	1.69	1.57

SUZ-KA15NAHZ

COP at	SLZ	SEZ	PEAD
47° F	2.60	2.70	3.00
17° F	1.91	2.15	2.29
5° F	1.84	1.88	1.81

SUZ-KA24NAHZ

COP at	PEAD	SVZ
47° F	3.80	3.10
17° F	2.10	1.80
5° F	1.75	1.60

SUZ-KA36NAHZ

COP at	PEAD	SVZ
47° F	3.70	3.30
17° F	2.20	1.80
5° F	1.75	1.60

MLZ-KP/Y

Recessed Ceiling Cassette



EZ FIT® Recessed Indoor Unit

The MLZ-KP EZ FIT® Ceiling Cassette recesses between the ceiling joists, providing a clean flush-mount appearance. The slim body design fits into shallow ceiling cavities, making the EZ FIT a popular selection for room upgrades or new construction projects. High/low ceiling airflow settings and automatic vane control personalize room comfort.

Capacities: 6,000 to 18,000 BTU/H

Sound: As low as 21 dB(A)

SEER2: Up to 22.90

HSPF2: Up to 11.90

COP: Up to 4.10

ENERGY STAR®: Yes





Ceiling Recessed

The EZ FIT® flush-mount design creates a more spacious feeling in the room. The recessed-ceiling-cassette indoor unit style provides a solution when wall space is limited or not available.

Slim Design

The MLZ-KP and MLZ-KY EZ FIT Ceiling Cassette recesses between the ceiling joists to provide a clean flush-mount appearance. With the EZ FIT's slim body design, installation is easy, even with shallow ceiling cavities. The EZ FIT is easily serviced from the bottom without the need to remove the grille.



Auto-vane Control

Outlet vanes can be moved left and right, and up and down, using the remote controller. This improved airflow control feature eliminates drafts.

Built-in Weekly Timer Function

Easily set desired temperatures and operation ON/OFF times to match lifestyle patterns. Reduce wasted energy consumption by using the timer to prevent forgetting to turn off the unit and eliminate temperature setting adjustments.

MLZ Specifications

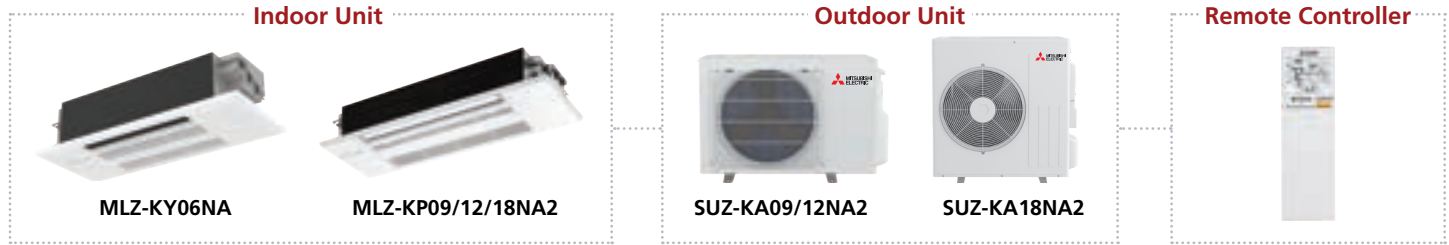

Econo Cool Air Purifying Anti-allergy Enzyme AUTO VANE SWING AUTO Weekly Timer ACO Auto Restart Optional Group Control M-NET connection Wi-Fi Interface MXZ connection 10°C Sleep

Drain Lift Up Flare connection Self Diagnosis Failure Recall inverter

Requires MLP-444W grille or MLP-448WU grille. MLZ-KY is multi-zone only.

Indoor Unit				MLZ-KY06NA	MLZ-KP09NA2	MLZ-KP12NA2	MLZ-KP18NA2
Outdoor Unit					SUZ-KA09NA2	SUZ-KA12NA2	SUZ-KA18NA2
Cooling	Capacity	Rated ¹	BTU/H	—	207699119	207699122	207699125
	Capacity Range	Min-Max	BTU/H	—	9,000	12,000	18,000
	Power Input	Rated ¹	W	—	3,600–9,000	3,900–12,000	6,600–18,000
	Moisture Removal	Pints/h		—	710	960	1,440
	Sensible Heat Factor			—	1.5	2.8	5.3
	Sensible Heat Factor - High Latent			—	0.820	0.740	0.670
Heating	Capacity at 47°F	Rated ²	BTU/H	—	12,000	15,400	20,000
	Capacity Range	Min-Max	BTU/H	—	4,010–13,000	4,600–17,000	8,200–22,800
	Power Input at 47°F	Rated ²	W	—	860	1,300	1,170
	Capacity at 17°F	Rated ³	BTU/H	—	7,700	9,900	13,100
		Max	BTU/H	—	8,300	10,900	14,900
	Capacity at 5°F	Max ⁴	BTU/H	—	6,100	7,900	10,700
Efficiency	SEER2			—	20.2	21.7	22.9
	EER2			—	12.6	12.2	12.5
	HSPF2			—	11.9	10.9	10.5
	COP			—	3.2	3.4	3.3
Indoor Unit	Air Flow Rate - Cooling (Quiet-Low-Med-High-SHigh)	Dry	CFM	152–166–184–198	212–254–282–311	212–258–297–332	212–293–346–403
		Wet	CFM	129–141–156–168	180–216–240–264	180–219–252–282	180–249–294–343
	Air Flow Rate - Heating (Quiet-Low-Med-High-SHigh)	Dry	CFM	152–173–194–212	212–247–290–325	212–272–311–350	212–311–364–417
	Sound Pressure Level (Quiet-Low-Med-High-SHigh)	Cooling	dB(A)	29–31–34–36	27–31–34–38	27–32–36–40	29–36–41–47
		Heating	dB(A)	29–32–35–37	26–29–34–37	26–32–36–40	26–37–42–48
	External Static Pressure		In. W.G.	—	—	—	—
	Condensate Lift Mechanism	Max Distance	In. [mm]	19-11/16 [500]	19-11/16 [500]	19-11/16 [500]	19-11/16 [500]
	Dimensions	H	In. [mm]	7-11/16 [194]	7-5/16 [185]	7-5/16 [185]	7-5/16 [185]
		W	In. [mm]	33-3/16 [842]	43-3/8 [1,102]	43-3/8 [1,102]	43-3/8 [1,102]
		D	In. [mm]	11-7/8 [301]	14-3/16 [360]	14-3/16 [360]	14-3/16 [360]
Weight	lbs [kg]		24.3 [11.0]	34 [15.5]	34 [15.5]	35 [16]	
Outdoor Unit	MCA	A		—	9.0	9.0	14.0
	MOCP	A		—	15	16	24
	Dimensions	H	In. [mm]	—	21-5/8 [550]	21-5/8 [550]	34-5/8 [880]
		W	In. [mm]	—	31-1/2 [800]	31-1/2 [800]	33-1/16 [840]
		D	In. [mm]	—	11-1/4 [285]	11-1/4 [285]	13 [330]
	Weight	lbs [kg]		—	81 [37]	81 [37]	127 [58]
	Air Flow Rate (Cooling/Heating)	CFM		—	1229/1172	1229/1172	1691/1691
Sound Pressure Level	Cooling	dB(A)	—	48	54	54	
	Heating	dB(A)	—	50	55	55	
Piping	Diameter	Gas (O.D.)	In. [mm]	—	3/8 [9.52]	3/8 [9.52]	1/2 [12.7]
		Liquid (O.D.)	In. [mm]	—	1/4 [6.35]	1/4 [6.35]	1/4 [6.35]
		Indoor Drain	In. [mm]	1-1/16 [26]	1-1/4 [32]	1-1/4 [32]	1-1/4 [32]
	Max. Length	ft [m]		—	65 [20]	65 [20]	100 [30]
Max. Height	ft [m]		—	40 [12]	40 [12]	50 [15]	
Electrical	Outdoor-Indoor ⁶	V, ph, Hz		—	208/230, 1, 60	208/230, 1, 60	208/230, 1, 60
	Recommended Breaker Size	A		—	15	15	15
Refrigerant Type				—	R410A	R410A	R410A
Guaranteed Temperature Operation Range	Cooling ⁷	°F DB [°C DB]		—	14 to 115 [-10.0 to 46.0]	14 to 115 [-10.0 to 46.0]	14 to 115 [-10.0 to 46.0]
	Heating	°F DB [°C DB]		—	-4 to 75 [-20.0 to 24.0]	-4 to 75 [-20.0 to 24.0]	-4 to 75 [-20.0 to 24.0]

Notes:

AHRI Rated Conditions (Rated data is determined at a fixed compressor speed)

¹Cooling (Indoor // Outdoor) °F 80 DB, 67 WB // 95 DB, 75 WB

²Heating at 47°F (Indoor // Outdoor) °F 70 DB, 60 WB // 47 DB, 43 WB

³Heating at 17°F (Indoor // Outdoor) °F 70 DB, 60 WB // 17 DB, 15 WB

⁴Heating at 5°F (Indoor // Outdoor) °F 70 DB, 60 WB // 5 DB, 4 WB

⁵Heating at -5°F (Indoor // Outdoor) °F 70 DB, 60 WB // -5 DB, -6 WB

Conditions

⁶Indoor units receive power from outdoor units through field-supplied interconnected wiring.

⁷Applications should be restricted to comfort cooling only; equipment cooling applications are not recommended for low ambient temperature conditions.

MLZ Specifications

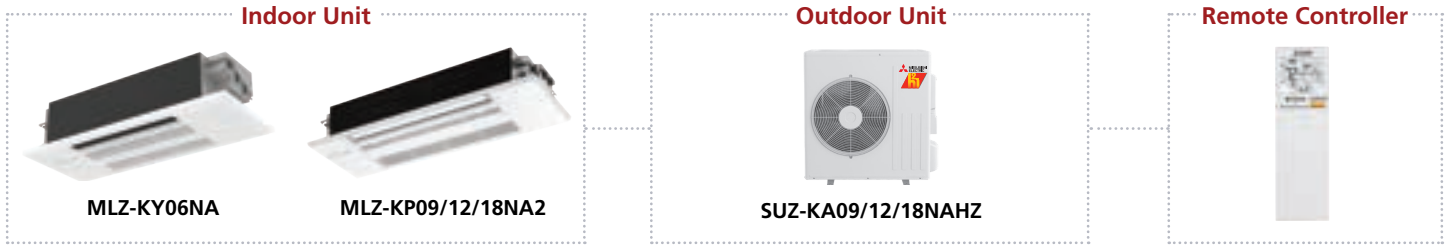

Requires MLP-444W grille or MLP-448WU grille. MLZ-KY is multi-zone only.

Indoor Unit				MLZ-KY06NA	MLZ-KP09NA2	MLZ-KP12NA2	MLZ-KP18NA2
Outdoor Unit					SUZ-KA09NAHZ	SUZ-KA12NAHZ	SUZ-KA18NAHZ
Cooling	Capacity	Rated ¹	BTU/H	—	204627031	204627032	204627034
	Capacity Range	Min-Max	BTU/H	—	9,000	12,000	16,700
	Power Input	Rated ¹	W	—	4,800-9,000	5,270-12,000	8,740-16,700
	Moisture Removal	Pints/h		—	720	940	1,335
	Sensible Heat Factor			—	1.8	3.1	5.1
	Sensible Heat Factor - High Latent			—	0.780	0.710	0.660
Heating	Capacity at 47°F	Rated ²	BTU/H	—	12,000	15,000	18,600
	Capacity Range	Min-Max	BTU/H	—	8,300-14,000	7,800-18,000	8,500-22,000
	Power Input at 47°F	Rated ²	W	—	840	1,130	1,780
	Capacity at 17°F	Rated ³	BTU/H	—	6,600	9,100	11,800
		Max	BTU/H	—	12,000	15,000	18,600
	Capacity at 5°F	Max ⁴	BTU/H	—	12,000	15,000	18,600
Efficiency	SEER2			—	20.5	20.8	19.2
	EER2			—	15.0	12.7	12.5
	HSPF2			—	9.0	9.0	8.5
	COP			—	4.1	3.8	3.0
Indoor Unit	Air Flow Rate - Cooling (Quiet-Lo-Med-High-SHigh)	Dry	CFM	152-166-184-198	212-254-282-311	212-258-297-332	212-293-346-403
		Wet	CFM	129-141-156-168	180-216-240-264	180-219-252-282	180-249-294-343
	Air Flow Rate - Heating (Quiet-Lo-Med-High-SHigh)	Dry	CFM	152-173-194-212	212-247-290-325	212-272-311-350	212-311-364-417
	Sound Pressure Level (Quiet-Lo-Med-High-SHigh)	Cooling	dB(A)	29-31-34-36	27-31-34-38	27-32-36-40	29-36-41-47
		Heating	dB(A)	29-32-35-37	26-29-34-37	26-32-36-40	26-37-42-48
	External Static Pressure		In. W.G.	—	—	—	—
	Condensate Lift Mechanism	Max Distance	In. [mm]	19-11/16 [500]	19-11/16 [500]	19-11/16 [500]	19-11/16 [500]
	Dimensions	H	In. [mm]	7-11/16 [194]	7-5/16 [185]	7-5/16 [185]	7-5/16 [185]
		W	In. [mm]	33-3/16 [842]	43-3/8 [1,102]	43-3/8 [1,102]	43-3/8 [1,102]
		D	In. [mm]	11-7/8 [301]	14-3/16 [360]	14-3/16 [360]	14-3/16 [360]
Weight	lbs [kg]		24.3 [11.0]	34 [15.5]	34 [15.5]	35 [16]	
Outdoor Unit	MCA	A		—	14.0	14.0	17.0
	MOCP	A		—	24	24	31
	Dimensions	H	In. [mm]	—	34-5/8 [880]	34-5/8 [880]	34-5/8 [880]
		W	In. [mm]	—	38-1/16 [840]	33-1/16 [840]	33-1/16 [840]
		D	In. [mm]	—	13 [330]	13 [330]	13 [330]
	Weight	lbs [kg]		—	129 [58.5]	129 [58.5]	131 [59.5]
	Air Flow Rate (Cooling/Heating)	CFM		—	1,691/1,691	1,691/1,691	2,020/1,930
Sound Pressure Level	Cooling	dB(A)	—	49	54	55	
	Heating	dB(A)	—	51	55	55	
Piping	Diameter	Gas (O.D.)	In. [mm]	—	3/8 [9.52]	3/8 [9.52]	1/2 [12.7]
		Liquid (O.D.)	In. [mm]	—	1/4 [6.35]	1/4 [6.35]	1/4 [6.35]
		Indoor Drain	In. [mm]	1-1/16 [26]	1-1/4 [32]	1-1/4 [32]	1-1/4 [32]
	Max. Length	ft [m]		—	65 [20]	65 [20]	100 [30]
Max. Height	ft [m]		—	40 [12]	40 [12]	50 [15]	
Electrical	Outdoor-Indoor ⁶	V, ph, Hz		—	208/230, 1, 60	208/230, 1, 60	208/230, 1, 60
	Recommended Breaker Size	A		—	15	15	20
Refrigerant Type				—	R410A	R410A	R410A
Guaranteed Temperature Operation Range	Cooling ⁷	°F DB [°C DB]		—	14 to 115 [-18.0 to 46.0]	14 to 115 [-18.0 to 46.0]	14 to 115 [-18.0 to 46.0]
	Heating	°F DB [°C DB]		—	-13 to 75 [-25.0 to 24.0]	-13 to 75 [-25.0 to 24.0]	-13 to 75 [-25.0 to 24.0]

Notes:
 AHRI Rated Conditions (Rated data is determined at a fixed compressor speed)
¹Cooling (Indoor // Outdoor) °F 80 DB, 67 WB // 95 DB, 75 WB
²Heating at 47°F (Indoor // Outdoor) °F 70 DB, 60 WB // 47 DB, 43 WB
³Heating at 17°F (Indoor // Outdoor) °F 70 DB, 60 WB // 17 DB, 15 WB
⁴Heating at 5°F (Indoor // Outdoor) °F 70 DB, 60 WB // 5 DB, 4 WB
⁵Heating at -5°F (Indoor // Outdoor) °F 70 DB, 60 WB // -5 DB, -6 WB

Conditions
⁶Indoor units receive power from outdoor units through field-supplied interconnected wiring.
⁷Applications should be restricted to comfort cooling only; equipment cooling applications are not recommended for low ambient temperature conditions.

SVZ

Multi-position Air Handler



Multi-position Air Handler

The SVZ Multi-position Air Handler, part of the Intelli-AIR™ family, boasts best-in-class construction with a durable black ZAM finish, 1" R4.2 insulation, and low cabinet leakage. The highly efficient EC motor features three different static pressure settings. Optional electric heat kits are available. This air handler unit features a built-in humidifier, ERV, and auxiliary heat control inputs.

Capacities: 12,000 to 36,000 BTU/H

Sound: As low as 29 dB(A)

SEER2: Up to 20.70

HSPF2: Up to 10.70

COP: Up to 4.20

ENERGY STAR®: Most systems



Best in Class

The SVZ is an ideal replacement for traditional forced-air systems or adding to new additions, with a durable black ZAM finish, 1" R4.2 insulation, and low cabinet leakage. The highly efficient EC motor features three different static pressure settings. Optional electric heat kits are available. This air handler unit features a built-in humidifier, ERV, and auxiliary heat control inputs.



Small Footprint

This air handler's compact design makes it possible to replace existing furnaces or air handlers. Choose either a single-zone or multi-zone system. Hybrid multi-zone applications provide a unique approach to solving zoning problems by mixing ducted and ductless indoor units.

SVZ Specifications



Air Filter
 ACO
 Auto Restart
 Optional
 Group Control
 M-NET connection
 Optional
 USNAP
 Optional
 Optional
 Optional
 T-STAT
 Optional
 MXZ connection

To confirm compatibility with the multi-zone system, refer to multi-zone model page.

Indoor Unit				SVZ-KP12NA	SVZ-KP18NA	SVZ-KP24NA	SVZ-KP30NA	SVZ-KP36NA	
Outdoor Unit				SUZ-KA12NA2	SUZ-KA18NA2	SUZ-KA24NA2	SUZ-KA30NA2	SUZ-KA36NA2	
AHRI Certified Reference Number				207699122	207699125	202392024	202392025	202392026	
Cooling	Capacity	Rated ¹	BTU/H	12,000	18,000	24,000	27,000	33,400	
	Capacity Range	Min-Max	BTU/H	4,300–12,000	6,200–18,000	12,400–24,000	13,500–27,000	11,600–33,400	
	Power Input	Rated ¹	W	940	1,360	1,920	2,160	3,711	
	Moisture Removal	Pints/h		1.2	2.4	4.1	2.4	4.7	
	Sensible Heat Factor			0.890	0.850	0.810	0.900	0.840	
	Sensible Heat Factor - High Latent			20	20	20	20	20	
Heating	Capacity at 47°F	Rated ²	BTU/H	15,000	21,600	25,300	30,000	33,400	
	Capacity Range	Min-Max	BTU/H	4,700–16,700	8,300–26,000	14,600–28,000	12,640–33,000	13,260–36,000	
	Power Input at 47°F	Rated ²	W	1,210	1,600	1,910	2,060	3,030	
	Capacity at 17°F	Rated ³	BTU/H	9,900	14,000	14,600	21,400	23,200	
		Max	BTU/H	9,900	14,000	14,600	21,400	23,200	
	Capacity at 5°F	Max ⁴	BTU/H	7,800	12,200	—	—	—	
Efficiency	SEER2			21.7	22.9	17.9	19.9	16.0	
	EER2			12.2	12.5	11.6	11.3	8.5	
	HSPF2			10.9	10.5	8.3	10.6	9.5	
	COP			3.6	3.9	3.8	4.2	3.2	
Indoor Unit	Air Flow Rate - Cooling (Quiet-Lo-Med-High-SHigh)	Dry	CFM	278–381–448	471–573–675	515–625–735	613–744–875	767–910–910	
		Wet	CFM	—	—	—	—	—	
	Air Flow Rate - Heating (Quiet-Lo-Med-High-SHigh)	Dry	CFM	278–381–448	471–573–675	515–625–735	613–744–875	767–910–910	
	Sound Pressure Level (Quiet-Lo-Med-High-SHigh)	Cooling	dB(A)	29–36–39	33–36–41	33–36–41	32–37–41	35–40–42	
		Heating	dB(A)	29–36–39	33–36–41	33–36–41	32–37–41	35–40–42	
	External Static Pressure		In. W.G.	0.30–0.5–0.8	0.30–0.5–0.8	0.30–0.5–0.8	0.30–0.5–0.8	0.30–0.5–0.8	
	Condensate Lift Mechanism	Max Distance	In. [mm]		—	—	—	—	—
			H	In. [mm]	39-13/16 [1011]	39-13/16 [1011]	39-13/16 [1011]	43-3/4 [1111]	43-3/4 [1111]
		Dimensions	W	In. [mm]	17 [432]	17 [432]	17 [432]	21 [533]	21 [533]
D			In. [mm]	21-5/8 [549]	21-5/8 [549]	21-5/8 [549]	21-5/8 [549]	21-5/8 [549]	
Weight		lbs [kg]	93 [42]	93 [42]	93 [42]	119 [54]	119 [54]		
Outdoor Unit	MCA	A		9.0	14.0	17.0	17.0	17.0	
		A		16	24	31	31	31	
	Dimensions	H	In. [mm]	21-5/8 [550]	34-5/8 [880]	34-5/8 [880]	34-5/8 [880]	34-5/8 [880]	
		W	In. [mm]	31-1/2 [800]	33-1/16 [840]	33-1/16 [840]	33-1/16 [840]	33-1/16 [840]	
		D	In. [mm]	11-1/4 [285]	13 [330]	13 [330]	13 [330]	13 [330]	
	Weight		lbs [kg]	81 [37]	127 [58]	129 [59]	129 [59]	129 [59]	
	Air Flow Rate (Cooling/Heating)		CFM	1229/1172	1691/1691	2020/1930	2020/1930	2020/1930	
	Sound Pressure Level	Cooling	dB(A)	54	54	55	55	55	
		Heating	dB(A)	55	55	55	55	55	
	Piping	Diameter	Gas (O.D.)	In. [mm]	3/8 [9.52]	1/2 [12.7]	5/8 [15.88]	5/8 [15.88]	5/8 [15.88]
Liquid (O.D.)			In. [mm]	1/4 [6.35]	1/4 [6.35]	3/8 [9.52]	3/8 [9.52]	3/8 [9.52]	
Indoor Drain			In. [mm]	3/4 [19.05]	3/4 [19.05]	3/4 [19.05]	3/4 [19.05]	3/4 [19.05]	
Max. Length			ft [m]	65 [20]	100 [30]	100 [30]	100 [30]	100 [30]	
Max. Height		ft [m]	40 [12]	50 [15]	100 [30]	100 [30]	100 [30]		
Electrical	Outdoor-Indoor ⁶	V, ph, Hz		208/230, 1, 60	208/230, 1, 60	208/230, 1, 60	208/230, 1, 60	208/230, 1, 60	
	Recommended Breaker Size	A		15	15	20	20	20	
Refrigerant Type				R410A	R410A	R410A	R410A	R410A	
Guaranteed Temperature Operation Range	Cooling ⁷	°F DB [°C DB]		14 to 115 [-10.0 to 46.0]	14 to 115 [-10.0 to 46.0]	14 to 115 [-10.0 to 46.0]	14 to 115 [-10.0 to 46.0]	14 to 115 [-10.0 to 46.0]	
	Heating	°F DB [°C DB]		-4 to 75 [-20.0 to 24.0]	-4 to 75 [-20.0 to 24.0]	14 to 75 [-10.0 to 24.0]	14 to 75 [-10.0 to 24.0]	14 to 75 [-10.0 to 24.0]	

Notes:

AHRI Rated Conditions (Rated data is determined at a fixed compressor speed)

¹Cooling (Indoor // Outdoor) °F 80 DB, 67 WB // 95 DB, 75 WB
²Heating at 47°F (Indoor // Outdoor) °F 70 DB, 60 WB // 47 DB, 43 WB
³Heating at 17°F (Indoor // Outdoor) °F 70 DB, 60 WB // 17 DB, 15 WB
⁴Heating at 5°F (Indoor // Outdoor) °F 70 DB, 60 WB // 5 DB, 4 WB
⁵Heating at -5°F (Indoor // Outdoor) °F 70 DB, 60 WB // -5 DB, -6 WB

Conditions

⁶Indoor units receive power from outdoor units through field-supplied interconnected wiring.

⁷Applications should be restricted to comfort cooling only; equipment cooling applications are not recommended for low ambient temperature conditions.

SVZ Specifications

Indoor Unit



SVZ-KP12/18/24/30/36NA

Outdoor Unit



SUZ-KA12/18NAHZ



SUZ-KA24NAHZ



SUZ-KA30/36NAHZ



To confirm compatibility with the multi-zone system, refer to multi-zone model page.

Indoor Unit				SVZ-KP12NA	SVZ-KP18NA	SVZ-KP24NA	SVZ-KP30NA	SVZ-KP36NA
Outdoor Unit				SUZ-KA12NAHZ	SUZ-KA18NAHZ	SUZ-KA24NAHZ	SUZ-KA30NAHZ	SUZ-KA36NAHZ
AHRI Certified Reference Number				204627032	204627034	206223008	206223009	206223010
Cooling	Capacity	Rated ¹	BTU/H	12,000	18,000	24,000	27,000	36,000
	Capacity Range	Min-Max	BTU/H	5,600–12,000	9,360–18,000	8,800–24,000	13,400–27,000	14,200–36,000
	Power Input	Rated ¹	W	860	1,440	2,420	2,100	3,760
	Moisture Removal	Pints/h		0.8	1.1	4.7	4.1	8.4
	Sensible Heat Factor			0.920	0.930	0.780	0.830	0.740
	Sensible Heat Factor - High Latent			20	20	20	20	20
Heating	Capacity at 47°F	Rated ²	BTU/H	15,000	21,600	23,000	32,000	37,000
	Capacity Range	Min-Max	BTU/H	7,700–18,000	8,800–28,000	9,400–28,800	13,000–34,000	13,800–40,000
	Power Input at 47°F	Rated ²	W	1,130	1,880	2,140	2,400	3,280
	Capacity at 17°F	Rated ³	BTU/H	8,900	14,300	19,200	21,400	32,800
		Max	BTU/H	15,000	21,600	23,000	32,000	37,000
	Capacity at 5°F	Max ⁴	BTU/H	15,000	21,600	23,000	32,000	37,000
Efficiency	SEER2			20.8	19.2	16.0	15.2	16.0
	EER2			12.7	12.5	9.9	12.8	9.5
	HSPF2			9.0	8.5	8.4	8.5	9.0
	COP			3.8	3.3	3.1	3.9	3.3
	Air Flow Rate - Cooling (Quiet-Lo-Med-High-SHigh)	Dry	CFM	278–381–448	471–573–675	515–625–735	613–744–875	767–910–910
	Wet	CFM	—	—	—	—	—	
Air Flow Rate - Heating (Quiet-Lo-Med-High-SHigh)	Dry	CFM	278–381–448	471–573–675	515–625–735	613–744–875	767–910–910	
Sound Pressure Level (Quiet-Lo-Med-High-SHigh)	Cooling	dB(A)	29–36–39	33–36–41	33–36–41	32–37–41	35–40–42	
	Heating	dB(A)	29–36–39	33–36–41	33–36–41	32–37–41	35–40–42	
External Static Pressure		In. W.G.	0.30–0.5–0.8	0.30–0.5–0.8	0.30–0.5–0.8	0.30–0.5–0.8	0.30–0.5–0.8	
Condensate Lift Mechanism	Max Distance	In. [mm]	—	—	—	—	—	
Indoor Unit	Dimensions	H	In. [mm]	39-13/16 [1011]	39-13/16 [1011]	39-13/16 [1011]	43-3/4 [1111]	43-3/4 [1111]
		W	In. [mm]	17 [432]	17 [432]	17 [432]	21 [533]	21 [533]
	Dimensions	D	In. [mm]	21-5/8 [549]	21-5/8 [549]	21-5/8 [549]	21-5/8 [549]	21-5/8 [549]
		Weight	lbs [kg]	93 [42]	93 [42]	93 [42]	119 [54]	119 [54]
	MCA	A		14.0	17.0	17.0	24.0	26.0
Outdoor Unit	MOC	A		24	31	27	40	42
	Dimensions	H	In. [mm]	34-5/8 [880]	34-5/8 [880]	37-1/8 [943]	52-11/16 [1338]	52-11/16 [1338]
		W	In. [mm]	33-1/16 [840]	33-1/16 [840]	37-13/32 [950]	41-5/16 [1050]	41-5/16 [1050]
		D	In. [mm]	13 [330]	13 [330]	14-3/16 [360]	14-3/16 [360]	14-3/16 [360]
	Weight	lbs [kg]		129 [58.5]	131 [59.5]	190 [86]	261 [118]	261 [118]
	Air Flow Rate (Cooling/Heating)	CFM		1,691/1,691	2,020/1,930	800/800	590/680	590/680
	Sound Pressure Level	Cooling	dB(A)	54	55	52	52	52
Heating		dB(A)	55	55	53	53	53	
Piping	Diameter	Gas (O.D.)	In. [mm]	3/8 [9.52]	1/2 [12.7]	5/8 [15.88]	5/8 [15.88]	5/8 [15.88]
		Liquid (O.D.)	In. [mm]	1/4 [6.35]	1/4 [6.35]	3/8 [9.52]	3/8 [9.52]	3/8 [9.52]
		Indoor Drain	In. [mm]	3/4 [19.05]	3/4 [19.05]	3/4 [19.05]	3/4 [19.05]	3/4 [19.05]
	Max. Length	ft [m]		65 [20]	100 [30]	100 [30]	245 [75]	245 [75]
Max. Height	ft [m]		40 [12]	50 [15]	100 [30]	100 [30]	100 [30]	
Electrical	Outdoor-Indoor ⁶	V, ph, Hz		208/230, 1, 60	208/230, 1, 60	208/230, 1, 60	208/230, 1, 60	208/230, 1, 60
	Recommended Breaker Size	A		15	20	25	35	35
Refrigerant Type				R410A	R410A	R410A	R410A	R410A
Guaranteed Temperature Operation Range	Cooling ⁷	°F DB [°C DB]		14 to 115 [-18.0 to 46.0]	14 to 115 [-18.0 to 46.0]	14 to 115 [-18.0 to 46.0]	0 to 115 [-18.0 to 46.0]	0 to 115 [-18.0 to 46.0]
		Heating	°F DB [°C DB]		-13 to 75 [-25.0 to 24.0]	-13 to 75 [-25.0 to 24.0]	-13 to 75 [-25.0 to 24.0]	-13 to 75 [-25.0 to 24.0]

Notes:

AHRI Rated Conditions (Rated data is determined at a fixed compressor speed)

- ¹Cooling (Indoor // Outdoor) °F 80 DB, 67 WB // 95 DB, 75 WB
- ²Heating at 47°F (Indoor // Outdoor) °F 70 DB, 60 WB // 47 DB, 43 WB
- ³Heating at 17°F (Indoor // Outdoor) °F 70 DB, 60 WB // 17 DB, 15 WB
- ⁴Heating at 5°F (Indoor // Outdoor) °F 70 DB, 60 WB // 5 DB, 4 WB
- ⁵Heating at -5°F (Indoor // Outdoor) °F 70 DB, 60 WB // -5 DB, -6 WB

Conditions

⁶Indoor units receive power from outdoor units through field-supplied inter-connected wiring.
⁷Applications should be restricted to comfort cooling only; equipment cooling applications are not recommended for low ambient temperature conditions.



SLZ-KF

Ceiling Cassette Indoor Unit



Four-way Ceiling Cassette

The SLZ Four-way recessed ceiling cassettes mount flush with the ceiling and fit into a 2' x 2' suspended ceiling grid. Indirect or Direct airflow settings direct supply air away from or toward room occupants. Each of the four vanes is fully customizable to provide 72 unique airflow patterns to suit the room's comfort requirements perfectly.

Capacities: 9,000 to 18,000 BTU/H

Sound: As low as 24 dB(A)

SEER2: Up to 20.80

HSPF2: Up to 10.70

COP: Up to 3.90

ENERGY STAR®: Most systems

↔ Fresh Air Intake

A duct opening is provided in the main body, making it possible to bring fresh air in directly, where it can then be heated to provide clean, refreshing comfort.



3D i-see Sensor®

The SLZ Model comes equipped with a 3D i-see Sensor, an infrared-ray sensor that measures temperatures at different positions throughout the space. While scanning the area, eight vertically arranged sensor elements analyze the room temperature in three dimensions. Based on temperature readings, the sensor detects the location of people in the room.

SLZ-KF Specifications

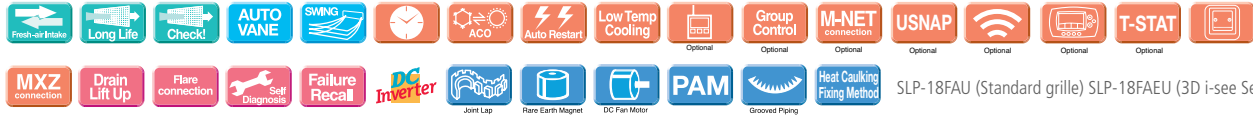
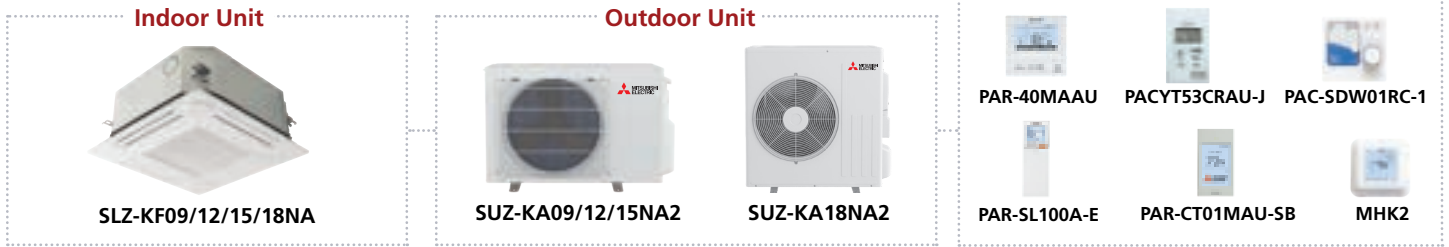

SLP-18FAU (Standard grille) SLP-18FAEU (3D i-see Sensor® grille)

Indoor Unit			SUZ-KF09NA		SUZ-KF12NA		SUZ-KF15NA		SUZ-KF18NA	
Outdoor Unit			SUZ-KA09NA2		SUZ-KA12NA2		SUZ-KA15NA2		SUZ-KA18NA2	
AHRI Certified Reference Number			207699119		207699122		202392062		207699125	
Cooling	Capacity	Rated ¹	BTU/H	9,000	12,000	14,100	17,700			
	Capacity Range	Min-Max	BTU/H	3,600-9,000	3,900-12,000	5,100-14,100	6,100-17,700			
	Power Input	Rated ¹	W	670	900	1,150	1,410			
	Moisture Removal		Pints/h	1.0	2.8	3.2	4.7			
	Sensible Heat Factor			0.870	0.740	0.750	0.710			
	Sensible Heat Factor - High Latent			—	—	—	—			
Heating	Capacity at 47°F	Rated ²	BTU/H	11,000	13,000	18,000	19,700			
	Capacity Range	Min-Max	BTU/H	4,010-12,000	4,800-13,000	5,100-19,100	8,400-20,900			
	Power Input at 47°F	Rated ²	W	4,010	4,800	5,100	8,400			
	Capacity at 17°F	Rated ³	BTU/H	6,900	8,900	11,900	12,900			
		Max	BTU/H	6,900	8,900	11,900	12,900			
	Capacity at 5°F	Max ⁴	BTU/H	5,600	6,100	8,900	9,800			
	Capacity at -5°F	Max ⁵	BTU/H	—	—	—	—			
Efficiency	SEER2			20.2	21.7	20.7	22.9			
	EER2			12.6	12.2	12.2	12.5			
	HSPF2			11.9	10.9	10.7	10.5			
	COP			3.9	2.9	3.0	3.1			
	Air Flow Rate - Cooling (Quiet-Lo-Med-High-SHigh)	Dry	CFM	230-265-300	230-265-335	245-315-405	300-420-475			
	Wet	CFM	207-239-270	207-252-302	221-284-365	270-378-429				
Air Flow Rate - Heating (Quiet-Lo-Med-High-SHigh)	Dry	CFM	230-265-335	230-265-335	245-315-405	300-420-475				
Sound Pressure Level (Quiet-Lo-Med-High-SHigh)	Cooling	dB(A)	25-28-31	25-30-34	27-34-39	32-40-43				
	Heating	dB(A)	25-28-31	25-30-34	27-34-39	32-40-43				
External Static Pressure		In. W.G.	—	—	—	—				
Condensate Lift Mechanism	Max Distance	In. [mm]	33 [850]	33 [850]	33 [850]	33 [850]				
Dimensions	H	In. [mm]	9-21/32 [245]	9-21/32 [245]	9-21/32 [245]	9-21/32 [245]				
	W	In. [mm]	22-7/16 [570]	22-7/16 [570]	22-7/16 [570]	22-7/16 [570]				
	D	In. [mm]	22-7/16 [570]	22-7/16 [570]	22-7/16 [570]	22-7/16 [570]				
	Weight	lbs [kg]		31 [13.9]	31 [13.9]	31 [13.9]	31 [13.9]			
Outdoor Unit	MCA	A		9.0	9.0	10.0	14.0			
	MOCP	A		15	16	18	24			
	Dimensions	H	In. [mm]	21-5/8 [550]	21-5/8 [550]	21-5/8 [550]	34-5/8 [880]			
		W	In. [mm]	31-1/2 [800]	31-1/2 [800]	31-1/2 [800]	33-1/16 [840]			
		D	In. [mm]	11-1/4 [285]	11-1/4 [285]	11-1/4 [285]	13 [330]			
	Weight	lbs [kg]		81 [37]	81 [37]	81 [37]	127 [58]			
	Air Flow Rate (Cooling/Heating)	CFM		1229/1172	1229/1172	1243/1229	1691/1691			
	Sound Pressure Level	Cooling	dB(A)	48	54	49	54			
		Heating	dB(A)	50	55	51	55			
	Piping	Diameter	Gas (O.D.)	In. [mm]	3/8 [9.52]	3/8 [9.52]	1/2 [12.7]	1/2 [12.7]		
Liquid (O.D.)			In. [mm]	1/4 [6.35]	1/4 [6.35]	1/4 [6.35]	1/4 [6.35]			
Indoor Drain			In. [mm]	1-1/4 [32]	1-1/4 [32]	1-1/4 [32]	1-1/4 [32]			
Max. Length		ft [m]		65 [20]	65 [20]	100 [30]				
Max. Height		ft [m]		40 [12]	40 [12]	40 [12]	50 [15]			
Electrical	Outdoor-Indoor ⁶	V, ph, Hz		208/230, 1, 60	208/230, 1, 60	208/230, 1, 60	208/230, 1, 60			
	Recommended Breaker Size	A		15	15	15	15			
Refrigerant Type				R410A	R410A	R410A	R410A			
Guaranteed Temperature Operation Range	Cooling ⁷	°F DB [°C DB]		14 to 115 [-10.0 to 46.0]	14 to 115 [-10.0 to 46.0]	14 to 115 [-10.0 to 46.0]	14 to 115 [-10.0 to 46.0]			
	Heating	°F DB [°C DB]		-4 to 75 [-20.0 to 24.0]	-4 to 75 [-20.0 to 24.0]	-4 to 75 [-20.0 to 24.0]	-4 to 75 [-20.0 to 24.0]			

Notes:

AHRI Rated Conditions (Rated data is determined at a fixed compressor speed)

- ¹Cooling (Indoor // Outdoor) °F 80 DB, 67 WB // 95 DB, 75 WB
- ²Heating at 47°F (Indoor // Outdoor) °F 70 DB, 60 WB // 47 DB, 43 WB
- ³Heating at 17°F (Indoor // Outdoor) °F 70 DB, 60 WB // 17 DB, 15 WB
- ⁴Heating at 5°F (Indoor // Outdoor) °F 70 DB, 60 WB // 5 DB, 4 WB
- ⁵Heating at -5°F (Indoor // Outdoor) °F 70 DB, 60 WB // -5 DB, -6 WB

Conditions

⁶Indoor units receive power from outdoor units through field-supplied interconnected wiring.

⁷Applications should be restricted to comfort cooling only; equipment cooling applications are not recommended for low ambient temperature conditions.

SLZ-KF Specifications

Indoor Unit



SLZ-KF09/12/15/18NA

Outdoor Unit



SUZ-KA09/12/15/18NAHZ

Optional Remote Controllers

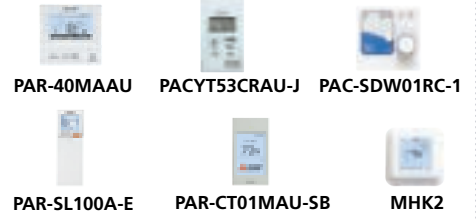

SLP-18FAU (Standard grille) SLP-18FAEU (3D i-see Sensor® grille)

Indoor Unit				SLZ-KF09NA	SLZ-KF12NA	SLZ-KF15NA	SLZ-KF18NA
Outdoor Unit				SUZ-KA09NAHZ	SUZ-KA12NAHZ	SUZ-KA15NAHZ	SUZ-KA18NAHZ
AHRI Certified Reference Number				204627031	204627032	204627033	204627034
Cooling	Capacity	Rated ¹	BTU/H	9,000	12,000	13,700	16,800
	Capacity Range	Min-Max	BTU/H	4,800-9,000	5,070-12,000	8,500-13,700	9,010-16,800
	Power Input	Rated ¹	W	600	940	1,095	1,340
	Moisture Removal	Pints/h		1.9	3.1	3.4	4.2
	Sensible Heat Factor			0.770	0.710	0.720	0.720
Sensible Heat Factor - High Latent				—	—	—	—
Heating	Capacity at 47°F	Rated ²	BTU/H	11,000	13,800	16,400	18,800
	Capacity Range	Min-Max	BTU/H	7,400-13,200	7,800-14,500	8,300-19,000	8,300-20,000
	Power Input at 47°F	Rated ²	W	820	1,170	1,830	2,020
	Capacity at 17°F	Rated ³	BTU/H	6,300	8,300	9,700	12,100
	Capacity at 5°F	Max ⁴	BTU/H	11,000	13,800	16,400	18,800
	Capacity at -5°F	Max ⁵	BTU/H	—	—	—	—
Efficiency	SEER2			20.5	20.8	17.5	19.2
	EER2			15.0	12.7	12.4	12.5
	HSPF2			9.0	9.0	7.9	8.5
	COP			3.9	3.4	2.6	2.7
Indoor Unit	Air Flow Rate - Cooling (Quiet-Lo-Med-High-SHigh)	Dry	CFM	230-265-300	230-265-335	245-315-405	300-420-475
		Wet	CFM	207-239-270	207-252-302	221-284-365	270-378-429
	Air Flow Rate - Heating (Quiet-Lo-Med-High-SHigh)	Dry	CFM	230-265-335	230-265-335	245-315-405	300-420-475
	Sound Pressure Level (Quiet-Lo-Med-High-SHigh)	Cooling	dB(A)	25-28-31	25-30-34	27-34-39	32-40-43
		Heating	dB(A)	25-28-31	25-30-34	27-34-39	32-40-43
	External Static Pressure		In. W.G.	—	—	—	—
	Condensate Lift Mechanism	Max Distance	In. [mm]	33 [850]	33 [850]	33 [850]	33 [850]
	Dimensions	H	In. [mm]	9-21/32 [245]	9-21/32 [245]	9-21/32 [245]	9-21/32 [245]
		W	In. [mm]	22-7/16 [570]	22-7/16 [570]	22-7/16 [570]	22-7/16 [570]
		D	In. [mm]	22-7/16 [570]	22-7/16 [570]	22-7/16 [570]	22-7/16 [570]
Weight	lbs [kg]		31 [13.9]	31 [13.9]	31 [13.9]	31 [13.9]	
Outdoor Unit	MCA	A		14.0	14.0	17.0	17.0
	MOCP	A		24	24	31	31
	Dimensions	H	In. [mm]	34-5/8 [880]	34-5/8 [880]	34-5/8 [880]	34-5/8 [880]
		W	In. [mm]	38-1/16 [840]	33-1/16 [840]	33-1/16 [840]	33-1/16 [840]
		D	In. [mm]	13 [330]	13 [330]	13 [330]	13 [330]
	Weight	lbs [kg]		129 [58.5]	129 [58.5]	131 [59.5]	131 [59.5]
	Air Flow Rate (Cooling/Heating)	CFM		1,691/1,691	1,691/1,691	2,020/1,930	2,020/1,930
	Sound Pressure Level	Cooling	dB(A)	49	54	55	55
Heating		dB(A)	51	55	55	55	
Piping	Diameter	Gas (O.D.)	In. [mm]	3/8 [9.52]	3/8 [9.52]	1/2 [12.7]	1/2 [12.7]
		Liquid (O.D.)	In. [mm]	1/4 [6.35]	1/4 [6.35]	1/4 [6.35]	1/4 [6.35]
		Indoor Drain	In. [mm]	1-1/4 [32]	1-1/4 [32]	1-1/4 [32]	1-1/4 [32]
	Max. Length	ft [m]		65 [20]	65 [20]	100 [30]	
Max. Height	ft [m]		40 [12]	40 [12]	40 [12]	50 [15]	
Electrical	Outdoor-Indoor ⁶	V, ph, Hz		208/230, 1, 60	208/230, 1, 60	208/230, 1, 60	208/230, 1, 60
	Recommended Breaker Size	A		15	15	20	20
Refrigerant Type				R410A	R410A	R410A	R410A
Guaranteed Temperature Operation Range	Cooling ⁷	°F DB [°C DB]		14 to 115 [-18.0 to 46.0]	14 to 115 [-18.0 to 46.0]	14 to 115 [-10.0 to 46.0]	14 to 115 [-18.0 to 46.0]
	Heating	°F DB [°C DB]		-13 to 75 [-25.0 to 24.0]	-13 to 75 [-25.0 to 24.0]	-13 to 75 [-25.0 to 24.0]	-13 to 75 [-25.0 to 24.0]

Notes:
 AHRI Rated Conditions
 (Rated data is determined at a fixed compressor speed)

Conditions
⁶Indoor units receive power from outdoor units through field-supplied interconnected wiring.
⁷Applications should be restricted to comfort cooling only; equipment cooling applications are not recommended for low ambient temperature conditions.

Notes:
¹Cooling (Indoor // Outdoor) °F 80 DB, 67 WB // 95 DB, 75 WB
²Heating at 47°F (Indoor // Outdoor) °F 70 DB, 60 WB // 47 DB, 43 WB
³Heating at 17°F (Indoor // Outdoor) °F 70 DB, 60 WB // 17 DB, 15 WB
⁴Heating at 5°F (Indoor // Outdoor) °F 70 DB, 60 WB // 5 DB, 4 WB
⁵Heating at -5°F (Indoor // Outdoor) °F 70 DB, 60 WB // -5 DB, -6 WB



SEZ-KD

Horizontal-ducted Indoor Unit

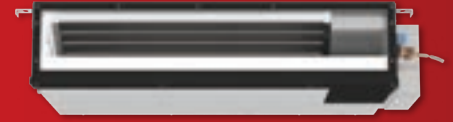

Low Static Intelli-AIR™ Ducted Solutions

Available as a single-zone or multi-zone unit, these low static units are designed to cool and heat one or two rooms through a short duct run.

Capacities: 9,000 to 15,000 BTU/H

Sound: As low as 23 dB(A)

SEER2: Up to 22.00

HSPF2: Up to 13.10

COP: Up to 4.00

ENERGY STAR®: Yes



Compact and Ceiling-Concealed

These low static units are designed to cool and heat one or two rooms through a short duct run. The SEZ series may be mounted in the attic, hidden in the ceiling or beneath the floor, or concealed behind a bulkhead. Only the intake-air grille and outlet vents are visible when using the SEZ Model ceiling-concealed indoor unit. The compact design requires minimal space and installs in buildings with lowered ceilings or attics.



SEZ-KD Specifications

Indoor Unit



SEZ-KD09/12/15/18NA4

Outdoor Unit

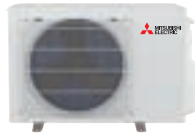

SUZ-KD09/12/15NAR1



SUZ-KD18NAR1

Optional Remote Controllers



PAR-40MAAU



PACYT53CRAU-J



PAC-SDW01RC-1



PAR-SL100A-E



PAR-CT01MAU-SB



MHK2



Indoor Unit			SEZ-KD09NA4R1	SEZ-KD12NA4R1	SEZ-KD15NA4R1	SEZ-KD18NA4R1	
Outdoor Unit			SUZ-KA09NA2	SUZ-KA12NA2	SUZ-KA15NA2	SUZ-KA18NA2	
AHRI Certified Reference Number			207699119	207699122	202392062	207699125	
Cooling	Capacity	Rated ¹	BTU/H	9,000	12,000	15,000	18,000
	Capacity Range	Min-Max	BTU/H	3,900–9,000	4,000–12,000	5,200–15,000	6,100–18,000
	Power Input	Rated ¹	W	700	930	1,150	1,310
	Moisture Removal		Pints/h	1.5	1.9	1.9	2.8
	Sensible Heat Factor			0.820	0.820	0.860	0.820
Sensible Heat Factor - High Latent			—	—	—	—	
Heating	Capacity at 47°F	Rated ²	BTU/H	12,000	15,000	18,000	21,600
	Capacity Range	Min-Max	BTU/H	4,200–12,800	4,800–16,800	5,000–21,600	8,100–25,600
	Power Input at 47°F	Rated ²	W	1,100	1,330	1,440	1,580
	Capacity at 17°F	Rated ³	BTU/H	7,600	10,000	11,700	13,900
		Max	BTU/H	6,700	9,000	11,900	13,100
Capacity at 5°F	Max ⁴	BTU/H	6,000	7,900	10,000	12,000	
Capacity at -5°F	Max ⁵	BTU/H	—	—	—	—	
Efficiency	SEER2			20.2	21.7	20.7	22.9
	EER2			12.6	12.2	12.2	12.5
	HSPF2			11.9	10.9	10.7	10.5
	COP			3.1	3.3	3.6	4.0
Indoor Unit	Air Flow Rate - Cooling (Quiet-Lo-Med-High-SHigh)	Dry	CFM	194–247–317	247–317–388	353–441–529	423–529–635
		Wet	CFM	174–222–285	222–285–349	317–396–476	381–476–572
	Air Flow Rate - Heating (Quiet-Lo-Med-High-SHigh)	Dry	CFM	194–247–317	247–317–388	353–441–529	423–529–635
	Sound Pressure Level (Quiet-Lo-Med-High-SHigh)	Cooling	dB(A)	23–26–30	23–28–33	30–34–37	30–34–38
		Heating	dB(A)	23–26–30	23–28–33	30–34–37	30–34–38
	External Static Pressure		In. W.G.	0.02–0.06–0.14–0.2	0.02–0.06–0.14–0.2	0.02–0.06–0.14–0.2	0.02–0.06–0.14–0.2
	Condensate Lift Mechanism	Max Distance	In. [mm]	2121/32 [550]	21-21/32 [550]	21-21/32 [550]	21-21/32 [550]
		H	In. [mm]	7-7/8 [200]	7-7/8 [200]	7-7/8 [200]	7-7/8 [200]
	Dimensions	W	In. [mm]	31-1/8 [790]	39 [990]	39 [990]	46-7/8 [1190]
D		In. [mm]	27-9/16 [700]	27-9/16 [700]	27-9/16 [700]	27-9/16 [700]	
Weight		lbs [kg]	42 [19.0]	50 [22.0]	54 [24.0]	62 [28.0]	
Outdoor Unit	MCA	A		9.0	9.0	10.0	14.0
	MOCP	A		15	16	18	24
	Dimensions	H	In. [mm]	21-5/8 [550]	21-5/8 [550]	21-5/8 [550]	34-5/8 [880]
		W	In. [mm]	31-1/2 [800]	31-1/2 [800]	31-1/2 [800]	33-1/16 [840]
		D	In. [mm]	11-1/4 [285]	11-1/4 [285]	11-1/4 [285]	13 [330]
	Weight	lbs [kg]	81 [37]	81 [37]	81 [37]	127 [58]	
	Air Flow Rate (Cooling/Heating)		CFM	1229/1172	1229/1172	1243/1229	1691/1691
Sound Pressure Level	Cooling	dB(A)	48	54	49	54	
	Heating	dB(A)	50	55	51	55	
Piping	Diameter	Gas (O.D.)	In. [mm]	3/8 [9.52]	3/8 [9.52]	1/2 [12.7]	1/2 [12.7]
		Liquid (O.D.)	In. [mm]	1/4 [6.35]	1/4 [6.35]	1/4 [6.35]	1/4 [6.35]
		Indoor Drain	In. [mm]	1-1/4 [32]	1-1/4 [32]	1-1/4 [32]	1-1/4 [32]
	Max. Length	ft [m]		65 [20]	65 [20]	65 [20]	100 [30]
Max. Height	ft [m]		40 [12]	40 [12]	40 [12]	50 [15]	
Electrical	Outdoor-Indoor ⁶	V, ph, Hz		208/230, 1, 60	208/230, 1, 60	208/230, 1, 60	208/230, 1, 60
	Recommended Breaker Size	A		15	15	15	15
Refrigerant Type				R410A	R410A	R410A	R410A
Guaranteed Temperature Operation Range	Cooling ⁷	°F DB [°C DB]		14 to 115 [-10.0 to 46.0]	14 to 115 [-10.0 to 46.0]	14 to 115 [-10.0 to 46.0]	14 to 115 [-10.0 to 46.0]
		Heating	°F DB [°C DB]		-4 to 75 [-20.0 to 24.0]	-4 to 75 [-20.0 to 24.0]	-4 to 75 [-20.0 to 24.0]

Notes:

AHRI Rated Conditions (Rated data is determined at a fixed compressor speed)

¹Cooling (Indoor // Outdoor)

²Heating at 47°F (Indoor // Outdoor)

³Heating at 17°F (Indoor // Outdoor)

⁴Heating at 5°F (Indoor // Outdoor)

⁵Heating at -5°F (Indoor // Outdoor)

⁶ 80 DB, 67 WB // 95 DB, 75 WB

⁷ 70 DB, 60 WB // 47 DB, 43 WB

⁸ 70 DB, 60 WB // 17 DB, 15 WB

⁹ 70 DB, 60 WB // 5 DB, 4 WB

¹⁰ 70 DB, 60 WB // -5 DB, -6 WB

Conditions

⁶Indoor units receive power from outdoor units through field-supplied interconnected wiring.

⁷Applications should be restricted to comfort cooling only; equipment cooling applications are not recommended for low ambient temperature conditions.

SEZ-KD Specifications

Indoor Unit



SEZ-KD09/12/15/18NA4

Outdoor Unit



SUZ-KD09/12/15/18NAR1

Optional Remote Controllers

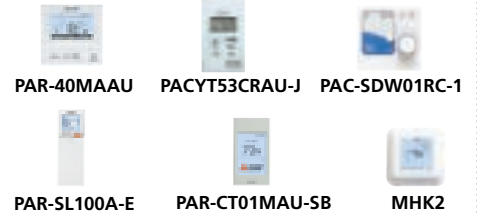

Indoor Unit			SEZ-KD09NA4R1	SEZ-KD12NA4R1	SEZ-KD15NA4R1	SEZ-KD18NA4R1	
Outdoor Unit			SUZ-KA09NAHZ	SUZ-KA12NAHZ	SUZ-KA15NAHZ	SUZ-KA18NAHZ	
AHRI Certified Reference Number			204627031	204627032	204627033	204627034	
Cooling	Capacity	Rated ¹	9,000	12,000	15,000	18,000	
	Capacity Range	Min-Max	4,500-9,000	5,210-12,000	9,000-15,000	9,200-18,000	
	Power Input	Rated ¹	690	920	1,200	1,370	
	Moisture Removal	Pints/h	1.7	2.5	2.8	2.0	
	Sensible Heat Factor		0.790	0.760	0.800	0.870	
Sensible Heat Factor - High Latent			—	—	—	—	
Heating	Capacity at 47°F	Rated ²	12,500	15,000	18,000	21,600	
	Capacity Range	Min-Max	8,100-13,300	7,700-18,000	8,600-22,400	8,800-28,000	
	Power Input at 47°F	Rated ²	1,300	1,120	1,920	1,840	
	Capacity at 17°F	Rated ³	8,700	9,000	12,200	14,200	
	Capacity at 5°F	Max ⁴	12,500	15,000	18,000	21,600	
Capacity at -5°F	Max ⁵	—	—	—	—		
Efficiency	SEER2		20.5	20.8	17.5	19.2	
	EER2		15.0	12.7	12.4	12.5	
	HSPF2		9.0	9.0	7.9	8.5	
	COP		2.8	3.9	2.7	3.4	
Indoor Unit	Air Flow Rate - Cooling (Quiet-Lo-Med-High-SHigh)	Dry	CFM	194-247-317	247-317-388	353-441-529	423-529-635
		Wet	CFM	174-222-285	222-285-349	317-396-476	381-476-572
	Air Flow Rate - Heating (Quiet-Lo-Med-High-SHigh)	Dry	CFM	194-247-317	247-317-388	353-441-529	423-529-635
	Sound Pressure Level (Quiet-Lo-Med-High-SHigh)	Cooling	dB(A)	23-26-30	23-28-33	30-34-37	30-34-38
		Heating	dB(A)	23-26-30	23-28-33	30-34-37	30-34-38
	External Static Pressure		In. W.G.	0.02-0.06-0.14-0.2	0.02-0.06-0.14-0.2	0.02-0.06-0.14-0.2	0.02-0.06-0.14-0.2
	Condensate Lift Mechanism		Max Distance	In. [mm]	21-21/32 [550]	21-21/32 [550]	21-21/32 [550]
	Dimensions	H	In. [mm]	7-7/8 [200]	7-7/8 [200]	7-7/8 [200]	7-7/8 [200]
		W	In. [mm]	31-1/8 [790]	39 [990]	39 [990]	46-7/8 [1190]
D		In. [mm]	27-9/16 [700]	27-9/16 [700]	27-9/16 [700]	27-9/16 [700]	
Weight	lbs [kg]		42 [19.0]	50 [22.0]	54 [24.0]	62 [28.0]	
Outdoor Unit	MCA	A		14.0	14.0	17.0	17.0
	MOCP	A		24	24	31	31
	Dimensions	H	In. [mm]	34-5/8 [880]	34-5/8 [880]	34-5/8 [880]	34-5/8 [880]
		W	In. [mm]	38-1/16 [840]	33-1/16 [840]	33-1/16 [840]	33-1/16 [840]
		D	In. [mm]	13 [330]	13 [330]	13 [330]	13 [330]
	Weight	lbs [kg]		129 [58.5]	129 [58.5]	131 [59.5]	131 [59.5]
	Air Flow Rate (Cooling/Heating)	CFM		1,691/1,691	1,691/1,691	2,020/1,930	2,020/1,930
Sound Pressure Level	Cooling	dB(A)	49	54	55	55	
	Heating	dB(A)	51	55	55	55	
Piping	Diameter	Gas (O.D.)	In. [mm]	3/8 [9.52]	3/8 [9.52]	1/2 [12.7]	1/2 [12.7]
		Liquid (O.D.)	In. [mm]	1/4 [6.35]	1/4 [6.35]	1/4 [6.35]	1/4 [6.35]
		Indoor Drain	In. [mm]	1-1/4 [32]	1-1/4 [32]	1-1/4 [32]	1-1/4 [32]
	Max. Length	ft [m]		65 [20]	65 [20]	65 [20]	100 [30]
Max. Height	ft [m]		40 [12]	40 [12]	40 [12]	50 [15]	
Electrical	Outdoor-Indoor ⁶	V, ph, Hz	208/230, 1, 60	208/230, 1, 60	208/230, 1, 60	208/230, 1, 60	
	Recommended Breaker Size	A	15	15	20	20	
Refrigerant Type			R410A	R410A	R410A	R410A	
Guaranteed Temperature Operation Range	Cooling ⁷	°F DB [°C DB]	14 to 115 [-18.0 to 46.0]	14 to 115 [-18.0 to 46.0]	14 to 115 [-18.0 to 46.0]	14 to 115 [-18.0 to 46.0]	
	Heating	°F DB [°C DB]	-13 to 75 [-25.0 to 24.0]	-13 to 75 [-25.0 to 24.0]	-13 to 75 [-25.0 to 24.0]	-13 to 75 [-25.0 to 24.0]	

Notes:

AHRI Rated Conditions (Rated data is determined at a fixed compressor speed)

- ¹Cooling (Indoor // Outdoor) °F 80 DB, 67 WB // 95 DB, 75 WB
- ²Heating at 47°F (Indoor // Outdoor) °F 70 DB, 60 WB // 47 DB, 43 WB
- ³Heating at 17°F (Indoor // Outdoor) °F 70 DB, 60 WB // 17 DB, 15 WB
- ⁴Heating at 5°F (Indoor // Outdoor) °F 70 DB, 60 WB // 5 DB, 4 WB
- ⁵Heating at -5°F (Indoor // Outdoor) °F 70 DB, 60 WB // -5 DB, -6 WB

Conditions

⁶Indoor units receive power from outdoor units through field-supplied interconnected wiring.

⁷Applications should be restricted to comfort cooling only; equipment cooling applications are not recommended for low ambient temperature conditions.



PEAD

Horizontal-ducted Indoor Unit



Mid Static Intelli-AIR™ Ducted Solutions

The PEAD Mid Static Intelli-AIR™ Ducted Solutions offer low capacities suitable for Passive Houses up to larger capacities ideal for light commercial uses such as offices, retail, and restaurants. The PEAD is capable of serving large spaces or multiple rooms supplied from a longer duct run.

Capacities: 9,000 to 15,000 BTU/H

Sound: As low as 23 dB(A)

SEER2: Up to 20.70

HSPF2: Up to 11.40

COP: Up to 4.00

ENERGY STAR®: Yes



Improved Energy Efficiency

Energy-saving efficiency has been improved, reducing electricity consumption and contributing to a further reduction in operating cost.



Compact Design

The height is only 9-7/8" for all sizes of this model, ranging from 12 to 42 KBTU/H. Its compact size allows for unit installations in low ceilings with minimal clearance space.

PEAD Specifications

Indoor Unit



PEAD-A09/12/15/18/24/30/36AA8

Outdoor Unit



SUZ-KA09/12/15NA2



SUZ-KA18NA2

Optional Remote Controllers



PAR-40MAAU



PACYT53CRAU-J



PAC-SDW01RC-1



PAR-SL100A-E



PAR-CT01MAU-SB



MHK2



Indoor Unit			PEAD-A09AA8	PEAD-A12AA8	PEAD-A15AA8	PEAD-A18AA8	PEAD-A24AA8	PEAD-A30AA8	PEAD-A36AA8	
Outdoor Unit			SUZ-KA09NA2	SUZ-KA12NA2	SUZ-KA15NA2	SUZ-KA18NA2	SUZ-KA24NA2	SUZ-KA30NA2	SUZ-KA36NA2	
AHRI Certified Reference Number			207699119	207699122	202392062	207699125	202392024	202392025	202392026	
Cooling	Capacity	Rated ¹	9,000	12,000	15,000	18,000	24,000	27,000	33,000	
	Capacity Range	Min-Max	4,300-9,000	4,400-12,000	5,500-15,000	6,200-18,000	12,000-24,000	13,200-27,000	14,000-33,000	
	Power Input	Rated ¹	720	930	1,150	1,270	1,920	2,160	3,510	
	Moisture Removal	Pints/h	0.8	1.1	1.3	3.2	4.9	3.9	4.8	
	Sensible Heat Factor		0.900	0.900	0.900	0.800	0.770	0.840	0.840	
Sensible Heat Factor - High Latent			—	—	—	—	—	—	—	
Heating	Capacity at 47°F	Rated ²	12,000	15,000	18,000	21,600	25,000	30,000	33,500	
	Capacity Range	Min-Max	3,960-13,000	4,800-17,000	4,900-21,500	8,120-25,600	14,400-28,000	15,860-33,000	14,750-36,000	
	Power Input at 47°F	Rated ²	900	1,160	1,350	1,600	1,990	2,410	3,170	
	Capacity at 17°F	Rated ³	7,600	9,900	11,300	14,000	15,000	22,400	23,000	
	Capacity at 5°F	Max ⁴	6,100	7,900	10,100	12,000	—	—	—	
Efficiency	SEER2		20.2	21.7	20.7	22.9	17.9	19.9	16.0	
	EER2		12.6	12.2	12.2	12.5	11.6	11.3	8.5	
	HSPF2		11.9	10.9	10.7	10.5	8.3	10.6	9.5	
	COP		3.9	3.7	3.9	3.9	3.6	3.6	3.0	
Indoor Unit	Air Flow Rate - Cooling (Quiet-Lo-Med-High-SHigh)	Dry	CFM	282-318-353	353-424-494	424-512-600	424-512-600	512-635-741	618-742-883	847-1024-1201
		Wet	CFM	254-286-318	318-382-445	382-461-540	382-461-540	461-572-667	556-668-795	762-922-1081
	Air Flow Rate - Heating (Quiet-Lo-Med-High-SHigh)	Dry	CFM	282-318-353	353-424-494	424-512-600	424-512-600	512-635-741	618-742-883	847-1024-1201
		Heating	dB(A)	26-28-31	27-31-34	29-34-37	29-34-37	28-32-36	30-34-39	35-39-42
	External Static Pressure		In. W.G.	0.14-0.2-0.28-0.4-0.6	0.14-0.2-0.28-0.4-0.6	0.14-0.2-0.28-0.4-0.6	0.14-0.2-0.28-0.4-0.6	0.14-0.2-0.28-0.4-0.6	0.14-0.2-0.28-0.4-0.6	0.14-0.2-0.28-0.4-0.6
	Condensate Lift Mechanism	Max Distance	In. [mm]	27-9/16 [700]	27-9/16 [700]	27-9/16 [700]	27-9/16 [700]	27-9/16 [700]	27-9/16 [700]	27-9/16 [700]
	Dimensions	H	In. [mm]	9-7/8 [250]	9-7/8 [250]	9-7/8 [250]	9-7/8 [250]	9-7/8 [250]	9-7/8 [250]	9-7/8 [250]
		W	In. [mm]	35-7/16 [900]	35-7/16 [900]	35-7/16 [900]	35-7/16 [900]	43-5/16 [1100]	43-5/16 [1100]	55-1/8 [1400]
		D	In. [mm]	28-7/8 [732]	28-7/8 [732]	28-7/8 [732]	28-7/8 [732]	28-7/8 [732]	28-7/8 [732]	28-7/8 [732]
	Weight		lbs [kg]	58 [26]	58 [26]	60 [27]	60 [27]	67 [30]	67 [30]	84 [38]
Outdoor Unit	MCA		A	9.0	9.0	10.0	14.0	17.0	17.0	
	MOC		A	15	16	18	24	31	31	
	Dimensions	H	In. [mm]	21-5/8 [550]	21-5/8 [550]	21-5/8 [550]	34-5/8 [880]	34-5/8 [880]	34-5/8 [880]	34-5/8 [880]
		W	In. [mm]	31-1/2 [800]	31-1/2 [800]	31-1/2 [800]	33-1/16 [840]	33-1/16 [840]	33-1/16 [840]	33-1/16 [840]
		D	In. [mm]	11-1/4 [285]	11-1/4 [285]	11-1/4 [285]	13 [330]	13 [330]	13 [330]	13 [330]
	Weight		lbs [kg]	81 [37]	81 [37]	81 [37]	127 [58]	129 [59]	129 [59]	129 [59]
	Air Flow Rate (Cooling/Heating)		CFM	1229/1172	1229/1172	1243/1229	1691/1691	2020/1930	2020/1930	2020/1930
Sound Pressure Level	Cooling	dB(A)	48	54	49	54	55	55	55	
	Heating	dB(A)	50	55	51	55	55	55	55	
Piping	Diameter	Gas (O.D.)	In. [mm]	3/8 [9.52]	3/8 [9.52]	1/2 [12.7]	1/2 [12.7]	5/8 [15.88]	5/8 [15.88]	5/8 [15.88]
		Liquid (O.D.)	In. [mm]	1/4 [6.35]	1/4 [6.35]	1/4 [6.35]	1/4 [6.35]	3/8 [9.52]	3/8 [9.52]	3/8 [9.52]
		Indoor Drain	In. [mm]	1-1/4 [32]	1-1/4 [32]	1-1/4 [32]	1-1/4 [32]	1-1/4 [32]	1-1/4 [32]	1-1/4 [32]
	Max. Length		ft [m]	65 [20]	65 [20]	65 [20]	100 [30]	100 [30]	100 [30]	
Max. Height		ft [m]	40 [12]	40 [12]	40 [12]	50 [15]	100 [30]	100 [30]		
Electrical	Outdoor-Indoor ⁶	V, ph, Hz	208/230, 1, 60	208/230, 1, 60	208/230, 1, 60	208/230, 1, 60	208/230, 1, 60	208/230, 1, 60	208/230, 1, 60	
	Recommended Breaker Size	A	15	15	15	15	20	20	20	
Refrigerant Type			R410A	R410A	R410A	R410A	R410A	R410A	R410A	
Guaranteed Temperature Operation Range	Cooling ⁷	°F DB [°C DB]	14 to 115 [-10.0 to 46.0]	14 to 115 [-10.0 to 46.0]	14 to 115 [-10.0 to 46.0]	14 to 115 [-10.0 to 46.0]	14 to 115 [-10.0 to 46.0]	14 to 115 [-10.0 to 46.0]	14 to 115 [-10.0 to 46.0]	
	Heating	°F DB [°C DB]	-4 to 75 [-20.0 to 24.0]	-4 to 75 [-20.0 to 24.0]	-4 to 75 [-20.0 to 24.0]	-4 to 75 [-20.0 to 24.0]	-4 to 75 [-10.0 to 24.0]	14 to 75 [-10.0 to 24.0]	14 to 75 [-10.0 to 24.0]	

Notes:

AHRI Rated Conditions (Rated data is determined at a fixed compressor speed)

¹Cooling (Indoor // Outdoor)

²Heating at 47°F (Indoor // Outdoor)

³Heating at 17°F (Indoor // Outdoor)

⁴Heating at 5°F (Indoor // Outdoor)

⁵Heating at -5°F (Indoor // Outdoor)

⁶80 DB, 67 WB // 95 DB, 75 WB

⁷70 DB, 60 WB // 47 DB, 43 WB

⁸70 DB, 60 WB // 17 DB, 15 WB

⁹70 DB, 60 WB // 5 DB, 4 WB

¹⁰70 DB, 60 WB // -5 DB, -6 WB

Conditions

¹¹Indoor units receive power from outdoor units through field-supplied interconnected wiring.

¹²Applications should be restricted to comfort cooling only; equipment cooling applications are not recommended for low ambient temperature conditions.

PEAD Specifications

Indoor Unit



PEAD-A09/12/15/18
/24/30/36AA8

Outdoor Unit



SUZ-KA09/12/15NAHZ

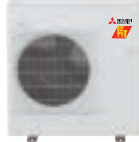

SUZ-KA24NAHZ



SUZ-KA30/36NAHZ

Optional Remote Controllers



PAR-40MAAU



PACYT53CRAU-J



PAC-SDW01RC-1



PAR-SL100A-E



PAR-CT01MAU-SB



MHK2



Indoor Unit			PEAD-A09AA8	PEAD-A12AA8	PEAD-A15AA8	PEAD-A18AA8	PEAD-A24AA8	PEAD-A30AA8	PEAD-A36AA8	
Outdoor Unit			SUZ-KA09NAHZ	SUZ-KA12NAHZ	SUZ-KA15NAHZ	SUZ-KA18NAHZ	SUZ-KA24NAHZ	SUZ-KA30NAHZ	SUZ-KA36NAHZ	
AHRI Certified Reference Number			204627031	204627032	204627033	204627034	206223008	206223009	206223010	
Cooling	Capacity	Rated ¹	BTU/H	9,000	12,000	15,000	18,000	24,000	30,000	33,000
	Capacity Range	Min-Max	BTU/H	5,000-9,000	5,770-12,000	9,600-15,000	9,320-18,000	10,000-24,000	14,600-30,000	15,600-33,000
	Power Input	Rated ¹	W	650	850	1,190	1,400	2,080	2,350	2,490
	Moisture Removal		Pints/h	1.4	1.9	2.4	3.6	6.9	6.5	3.6
	Sensible Heat Factor			0.820	0.820	0.820	0.780	0.680	0.760	0.880
Sensible Heat Factor - High Latent			—	—	—	—	—	—	—	
Heating	Capacity at 47°F	Rated ²	BTU/H	12,000	15,000	18,000	21,600	25,000	32,000	37,000
	Capacity Range	Min-Max	BTU/H	8,200-14,000	7,900-18,000	8,800-23,000	8,800-28,000	10,000-28,000	14,700-34,000	17,400-40,000
	Power Input at 47°F	Rated ²	W	910	1,100	1,710	1,890	1,920	2,740	2,940
	Capacity at 17°F	Rated ³	BTU/H	6,800	9,000	11,700	14,200	18,000	21,000	25,400
	Capacity at 5°F	Max ⁴	BTU/H	12,000	15,000	18,000	21,600	25,000	32,000	37,000
	Capacity at -5°F	Max ⁵	BTU/H	—	—	—	—	—	—	—
Efficiency	SEER2			20.5	20.8	17.5	19.2	16.0	15.2	16.0
	EER2			15.0	12.7	12.4	12.5	9.9	12.8	9.5
	HSPF2			9.0	9.0	7.9	8.5	8.4	8.5	9.0
	COP			3.8	3.9	3.0	3.3	3.8	3.4	3.6
Indoor Unit	Air Flow Rate - Cooling (Quiet-Low-Med-High-SHigh)	Dry	CFM	282-318-353	353-424-494	424-512-600	424-512-600	512-635-741	618-742-883	847-1024-1201
		Wet	CFM	254-286-318	318-382-445	382-461-540	382-461-540	461-572-667	556-668-795	762-922-1081
	Air Flow Rate - Heating (Quiet-Low-Med-High-SHigh)	Dry	CFM	282-318-353	353-424-494	424-512-600	424-512-600	512-635-741	618-742-883	847-1024-1201
		Heating	dB(A)	26-28-31	27-31-34	29-34-37	29-34-37	28-32-36	30-34-39	35-39-42
	Sound Pressure Level (Quiet-Low-Med-High-SHigh)	Cooling	dB(A)	26-28-31	27-31-34	29-34-37	29-34-37	28-32-36	30-34-39	35-39-42
		Heating	dB(A)	26-28-31	27-31-34	29-34-37	29-34-37	28-32-36	30-34-39	35-39-42
	External Static Pressure		In. W.G.	0.14-0.2-0.28-0.4-0.6	0.14-0.2-0.28-0.4-0.6	0.14-0.2-0.28-0.4-0.6	0.14-0.2-0.28-0.4-0.6	0.14-0.2-0.28-0.4-0.6	0.14-0.2-0.28-0.4-0.6	0.14-0.2-0.28-0.4-0.6
	Condensate Lift Mechanism	Max Distance	In. [mm]	27-9/16 [700]	27-9/16 [700]	27-9/16 [700]	27-9/16 [700]	27-9/16 [700]	27-9/16 [700]	27-9/16 [700]
		H	In. [mm]	9-7/8 [250]	9-7/8 [250]	9-7/8 [250]	9-7/8 [250]	9-7/8 [250]	9-7/8 [250]	9-7/8 [250]
	Dimensions	W	In. [mm]	35-7/16 [900]	35-7/16 [900]	35-7/16 [900]	35-7/16 [900]	43-5/16 [1100]	43-5/16 [1100]	55-1/8 [1400]
D		In. [mm]	28-7/8 [732]	28-7/8 [732]	28-7/8 [732]	28-7/8 [732]	28-7/8 [732]	28-7/8 [732]	28-7/8 [732]	
Weight		lbs [kg]	58 [26]	58 [26]	60 [27]	60 [27]	67 [30]	67 [30]	84 [38]	
Outdoor Unit	MCA	A	14.0	14.0	17.0	17.0	17.0	24.0	26.0	
	MOC	A	24	24	31	31	27	40	42	
	Dimensions	H	In. [mm]	34-5/8 [880]	34-5/8 [880]	34-5/8 [880]	34-5/8 [880]	37-1/8 [943]	52-11/16 [1338]	52-11/16 [1338]
		W	In. [mm]	38-1/16 [840]	33-1/16 [840]	33-1/16 [840]	33-1/16 [840]	37-13/32 [950]	41-5/16 [1050]	41-5/16 [1050]
		D	In. [mm]	13 [330]	13 [330]	13 [330]	13 [330]	14-3/16 [360]	14-3/16 [360]	14-3/16 [360]
	Weight	lbs [kg]	129 [58.5]	129 [58.5]	131 [59.5]	131 [59.5]	190 [86]	261 [118]	261 [118]	
Air Flow Rate (Cooling/Heating)	CFM	1,691/1,691	1,691/1,691	2,020/1,930	2,020/1,930	800/800	590/680	590/680		
Sound Pressure Level	Cooling	dB(A)	49	54	55	55	52	52	52	
	Heating	dB(A)	51	55	55	55	53	53	53	
Piping	Diameter	Gas (O.D.)	In. [mm]	3/8 [9.52]	3/8 [9.52]	1/2 [12.7]	1/2 [12.7]	5/8 [15.88]	5/8 [15.88]	5/8 [15.88]
		Liquid (O.D.)	In. [mm]	1/4 [6.35]	1/4 [6.35]	1/4 [6.35]	1/4 [6.35]	3/8 [9.52]	3/8 [9.52]	3/8 [9.52]
	Indoor Drain	In. [mm]	1-1/4 [32]	1-1/4 [32]	1-1/4 [32]	1-1/4 [32]	1-1/4 [32]	1-1/4 [32]	1-1/4 [32]	
	Max. Length	ft [m]	65 [20]	65 [20]	65 [20]	100 [30]	100 [30]	245 [75]	245 [75]	
Max. Height	ft [m]	40 [12]	40 [12]	40 [12]	50 [15]	100 [30]	100 [30]	100 [30]		
Electrical	Outdoor-Indoor ⁶	V, ph, Hz	208/230, 1, 60	208/230, 1, 60	208/230, 1, 60	208/230, 1, 60	208/230, 1, 60	208/230, 1, 60	208/230, 1, 60	
	Recommended Breaker Size	A	15	15	20	20	25	35	35	
Refrigerant Type			R410A	R410A	R410A	R410A	R410A	R410A	R410A	
Guaranteed Temperature Operation Range	Cooling ⁷	°F DB [°C DB]	14 to 115 [-18.0 to 46.0]	14 to 115 [-18.0 to 46.0]	14 to 115 [-10.0 to 46.0]	14 to 115 [-18.0 to 46.0]	0 to 115 [-18.0 to 46.0]	0 to 115 [-18.0 to 46.0]	0 to 115 [-18.0 to 46.0]	
	Heating	°F DB [°C DB]	-13 to 75 [-25.0 to 24.0]	-13 to 75 [-25.0 to 24.0]	-13 to 75 [-25.0 to 24.0]	-13 to 75 [-25.0 to 24.0]	-13 to 75 [-25.0 to 24.0]	-13 to 75 [-25.0 to 24.0]	-13 to 75 [-25.0 to 24.0]	

Notes:
 AHRI Rated Conditions (Rated data is determined at a fixed compressor speed)
 Conditions
¹Cooling (Indoor // Outdoor) °F 80 DB, 67 WB // 95 DB, 75 WB
²Heating at 47°F (Indoor // Outdoor) °F 70 DB, 60 WB // 47 DB, 43 WB
³Heating at 17°F (Indoor // Outdoor) °F 70 DB, 60 WB // 17 DB, 15 WB
⁴Heating at 5°F (Indoor // Outdoor) °F 70 DB, 60 WB // 5 DB, 4 WB
⁵Heating at -5°F (Indoor // Outdoor) °F 70 DB, 60 WB // -5 DB, -6 WB

⁶Indoor units receive power from outdoor units through field-supplied interconnected wiring.
⁷Applications should be restricted to comfort cooling only; equipment cooling applications are not recommended for low ambient temperature conditions.



P-Series

Designed for light commercial and residential applications, perfectly suited for mechanical/electrical areas where critical cooling is needed.



P-Series Product Range

Indoor Units



PLA
Four-way Ceiling
Cassette



PKA-LA
Wall-mounted



PKA-KA
Wall-mounted



PVA
Multi-position
Air Handler



PEAD Mid-static
Horizontal Ducted



PCA
Ceiling-suspended



intelli-HEAT™
Cased Coil

Outdoor Units

Cooling Only



PUY-A12NKA7



PUY-A18NKA7



PUY-A24NHA7



PUY-A30NHA7

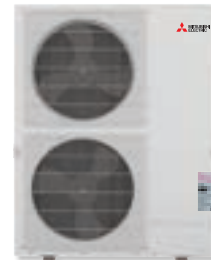

PUY-A36NKA7



PUY-A42NKA7

Heat Pumps



PUZ-A12NKA7



PUZ-A18NKA7



PUZ-A24NHA7



PUZ-A30NHA7

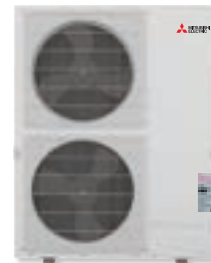

PUZ-A36NKA7



PUZ-A42NKA7

Hyper-heating INVERTER® Heat Pumps



PUZ-HA24NHA1



PUZ-HA30NKA



PUZ-HA36NKA



PUZ-HA42NKA1



Outdoor Unit Features

Energy Saving Efficiency

Improved Compressor Technology

Industry-leading energy efficiency has been achieved through the optimization of a newly designed compressor and the use of the latest energy-saving technologies. All compressors offer high performance due to advanced variable-speed INVERTER-drive technology, which varies the compressor speed dynamically to adapt to the conditioning requirements of the room continuously.

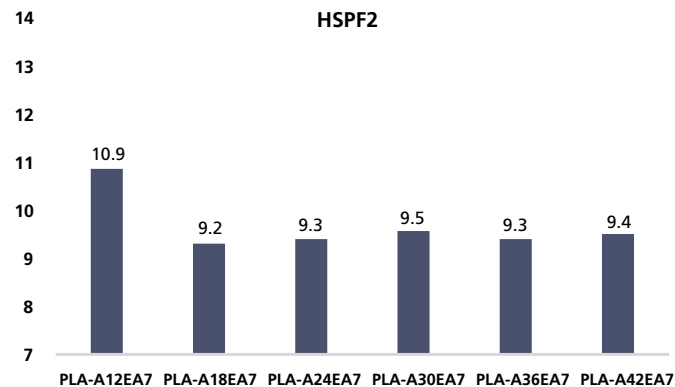
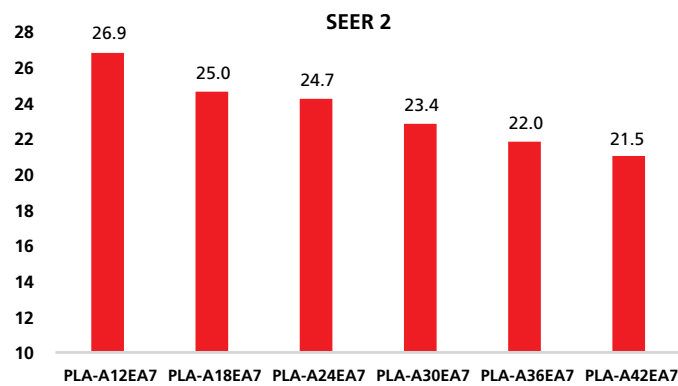

Enhanced Outdoor Unit Fan (A36-42)

A newly designed fan increases airflow capacity and reduces operation noise. The opening for the fan in the outdoor unit is 21-3/4" in diameter. Exchanging heat more efficiently contributes to increased energy savings and lower noise levels.



A newly designed fan increases airflow capacity and reduces operation noise.

Highly Efficient Heat Exchanger (A36-42)

The A36-42 units use a 5/16" diameter pipe. The high-density heat exchanger contributes to efficient heat exchange and reduces the amount of refrigerant used, which benefits the environment.

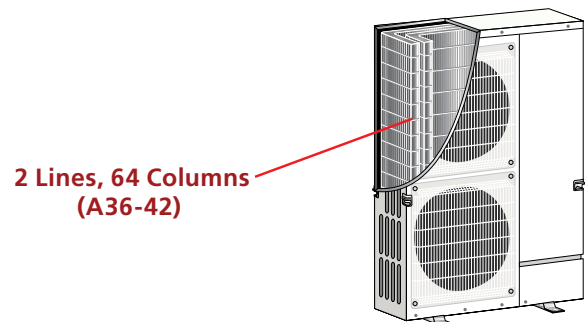

2 Lines, 64 Columns (A36-42)

Air Conditioning Features (PUY)

Reliability and Performance in Low Ambient Conditions (PUY Model)

The PUY Model cooling-only unit provides cooling all year round, even in cold climate low ambient conditions. By controlling the fan speed, the PUY can offer stable cooling operation down to -40° F.

Optional Air Protection Guide/Wind Baffle is needed when ambient temperature is under 23° F.

Low Ambient Cooling Operation Range

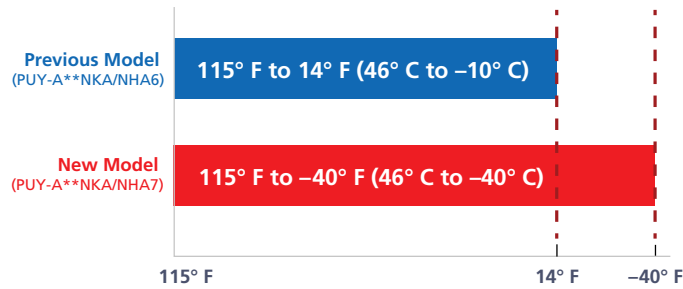

Continuous Operation

A control algorithm allows for stable continuous operation to meet cooling requirements all year round.

Backup Rotation Function

The two units operate alternately to maintain equal runtimes and equivalent wear, extending their life. In this configuration, if one unit experiences issues, the other unit continues to operate. Can only be used with PAR-40MAAU controller.

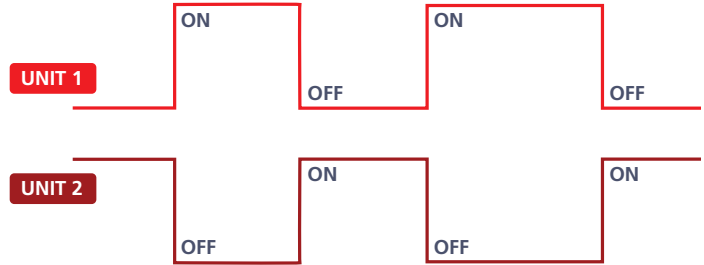

Quick Auto Restart After Power Failure

In case of power failures, auto restart time shortens from 180 seconds to 60 seconds. The unit starts back up in the same operation mode it ran when the power failure occurred.

Heat Pump Features (PUZ)

Wide Operation Range

P-Series heat pumps offer a wide temperature operation range, easily fitting many climate conditions.

1. In case that the air protection guide wind baffle is installed. (In case the wind baffle is not installed, the minimum temperature will be 23° F (-5° C) DB) 2. A24/30/36/42

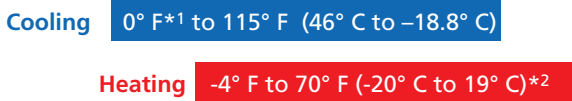

Energy Efficient

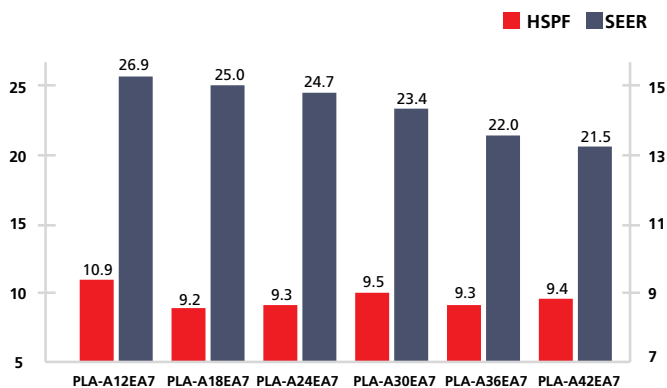

Flexible Installation

Long piping lengths enable system design flexibility for applications such as apartment buildings, churches, or strip malls.

Outdoor Unit	Piping	
	Length (ft.)	Height (ft.)
PUZ-A12NKA7	100	100
PUZ-A18NKA7	100	100
PUZ-A24NKA7	165	100
PUZ-A30NKA7	165	100
PUZ-A36NKA7	165	100
PUZ-A42NKA7	165	100

Hyper-Heating INVERTER® Features (PUZ-HA)

Improved Heating Performance

Our unique Flash Injection circuit achieves remarkably high heating performance. This technology has resulted in excellent heating capacity ratings in outdoor temperatures as low as 5° F. The guaranteed heating operation range of the heating mode extends to -13° F.

Improved Comfort

The Flash Injection circuit improves start-up and recovery from the defrosting operation. The defrost operation control improves the required defrost frequency. These features enable the temperature to reach the set point fast and contribute to maintaining the desired setting.

Approximately 30% Higher Than Model One Size Larger
(Example of 30,000 BTU/H Model)

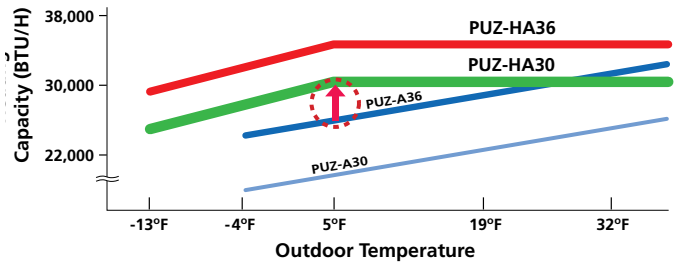

Guaranteed Heating Operation Range is Extended to -13° F Ambient Temperature

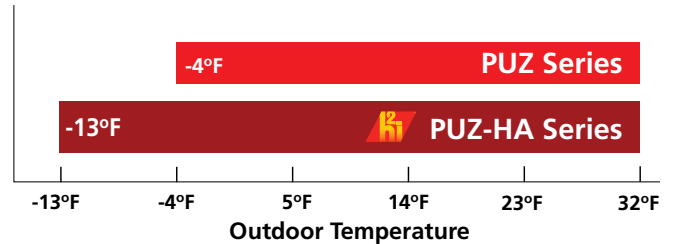

Quick Start-up

Operation at 36° F outdoor temperature

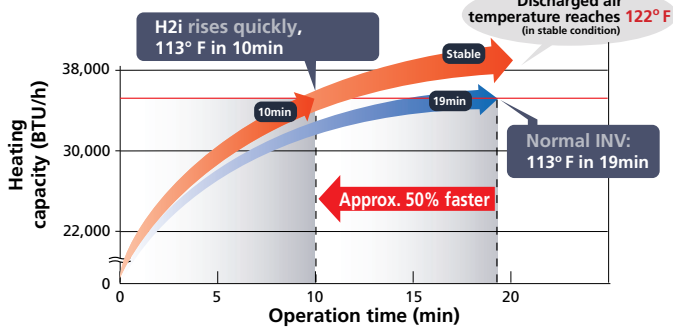

Operation at -4° F outdoor temperature

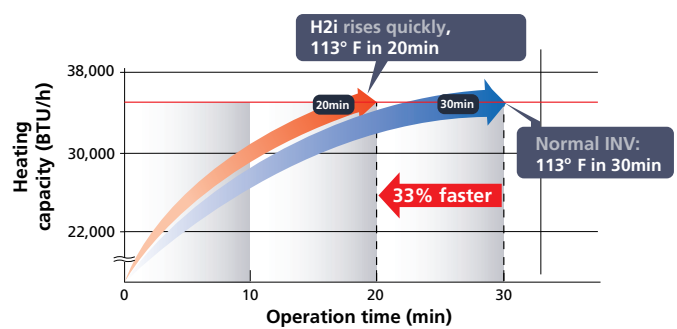

H2i Defrost Control and Faster Recovery from Defrost Operation

Field Test Results: Office building in Asahikawa, Hokkaido, Japan

Operation data for 25 Jan. 2005

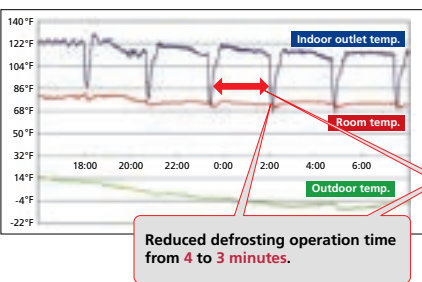

Operation data for 2 Dec. 2004

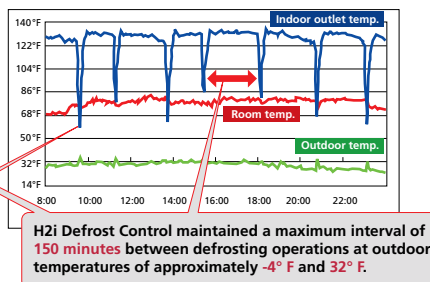

Installation example

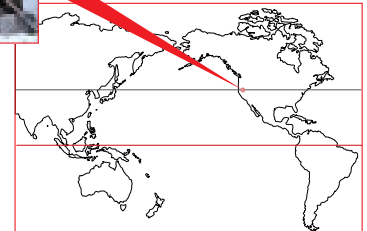



P-Series Capacity Range

Cooling Only (PUY)

	Model	12,000 BTU/H	18,000 BTU/H	24,000 BTU/H	30,000 BTU/H	36,000 BTU/H	42,000 BTU/H
Ceiling Cassette	 PLA Model		•	•	•	•	•
Wall-mounted	 PKA Model	•	•	•	•	•	
Multi-position Air Handler	 PVA Model	•	•	•	•	•	•
Horizontal-ducted	 PEAD Model	•	•	•	•	•	•
Ceiling-suspended	 PCA Model			•	•	•	•
intelli-HEAT™	 PAA Model			•	•	•	•

Heat Pumps (PUZ)

	Model	12,000 BTU/H	18,000 BTU/H	24,000 BTU/H	30,000 BTU/H	36,000 BTU/H	42,000 BTU/H
Ceiling Cassette	 PLA Model		•	•	•	•	•
Wall-mounted	 PKA Model	•	•	•	•	•	
Multi-position Air Handler	 PVA Model	•	•	•	•	•	•
Horizontal-ducted	 PEAD Model	•	•	•	•	•	•
Ceiling-suspended	 PCA Model			•	•	•	•
intelli-HEAT™	 PAA Model			•	•	•	•

Hyper-heating (PUZ-HA)

	Model	24,000 BTU/H	30,000 BTU/H	36,000 BTU/H	42,000 BTU/H
Ceiling Cassette	 PLA Model	•	•	•	•
Wall-mounted	 PKA Model	•	•	•	•
Multi-position Air Handler	 PVA Model	•	•	•	•
Horizontal-ducted	 PEAD Model	•	•	•	•
Ceiling-suspended	 PCA Model	•	•	•	•
intelli-HEAT™	 PAA Model	•	•	•	•



P-Series Features

Category	Feature	P-Series										
		Indoor unit	PLA-A12/18/24/30/36/42EA7						PKA-A12/18LA PKA-A24/30/36KA7			
		Outdoor Unit	PUZ-A	PUY-A	PUZ-HA	MXZ-3C	MXZ-4C	MXZ-5C	MXZ-5M	PUZ-A	PUY-A	PUZ-HA
Functions	i-see Sensor™	Radiant Temperature Control (3D i-see Sensor®)	•	•	•	•	•	•	•			
		AREA Temperature Monitor	•	•	•	•	•	•	•			
	Energy Saving	ENERGY STAR®	12/18/ 24/36	12/18/ 24/36	30/36							
		Demand Function (PAR-33MAA)	•	•	•					•	•	•
	Air Quality	Fresh-air Intake	•	•	•	•	•	•	•			
		High-efficiency Filter										
		Long-life Filter	•	•	•	•	•	•	•			
		Filter Check Signal	•	•	•	•	•	•	•	Opt	Opt	Opt
	Air Distribution	Vertical Swing	•	•	•	•	•	•	•	•	•	•
		Horizontal Swing										
		High Ceiling Mode	•	•	•	•	•	•	•			
		Low Ceiling Mode	•	•	•	•	•	•	•			
		Auto Fan Speed Mode	•	•	•	•	•	•	•	•	•	•
	Convenience	Auto Restart	•	•	•	•	•	•	•	•	•	•
		Low Temperature Cooling	•	•	•	•	•	•	•	•	•	•
		12H On/Off Operation Timer										
		24H On/Off Operation Timer										
		Weekly Timer										
	Maintenance	Self-Diagnostic Function	•	•	•	•	•	•	•	•	•	•
		Failure Recall Function	•	•	•	•	•	•	•	•	•	•
Blue Fin		•*2	•*2				•*1	•*1	•	•*2	•*2	

*1 Branch box units only: MXZ-8C48NA2, MXZ-8C60NA2, MXZ-4C36HNNHZ2, MXZ-5C42HNNHZ2, and MXZ-8C48HNNHZ2 *2 Sea coast protection models only
Opt: Separate parts must be purchased.

P-Series																						
PCA-A24/30/36/42KA7			PEAD-A12/18/24/30/36/42AA7									PVA-A12/18/24/30/36/42AA7			intelli-HEAT™							
MXZ-3C	MXZ-4C	MXZ-5C	PUZ-A	PUY-A	PUZ-HA	MXZ-2C	MXZ-3C	MXZ-4C	MXZ-5C	MXZ-SM	PUZ-A	PUY-A	PUZ-HA	PUZ-A	PUY-A	PUZ-HA	MXZ-2C	MXZ-3C	MXZ-4C	MXZ-5C	MXZ-SM	
Opt	Opt	Opt																				
			12	12	30/36									12	12	30/36						
•	•	•	•	•	•									•	•	•	•	•	•	•	•	•
•	•	•																				
Opt	Opt	Opt																				
•	•	•	•	•	•	•	•	•	•	•												
•	•	•	•	•	•	•	•	•	•	•												
•	•	•																				
•	•	•	•	•	•	•	•	•	•	•	•	•	•	•	•	•	•	•	•	•	•	•
•	•	•	•	•	•	•	•	•	•	•	•	•	•	•	•	•	•	•	•	•	•	•
•	•	•	•	•	•	•	•	•	•	•	•	•	•	•	•	•	•	•	•	•	•	•
•	•	•	•	•	•	•	•	•	•	•	•	•	•	•	•	•	•	•	•	•	•	•
•	•	•	•	•	•	•	•	•	•	•	•	•	•	•	•	•	•	•	•	•	•	•
•*2	•*2		•*2	•*2					•*1	•*1	•	•*2	•*2		•	•						

PLA

Ceiling Cassette Indoor Unit



Four-way Ceiling Cassette

The PLA Four-way Ceiling Cassette offers an extensive lineup with capacities ranging from 12 to 42 KBTU/H. The four-way ceiling cassette provides an astonishing 72 unique airflow patterns available to accommodate different room layouts. Select any combination of 2, 3, or 4 vanes to deliver air into the area.

Capacities: 12,000 to 42,000 BTU/H

Sound: As low as 27 dB(A)

SEER2: Up to 26.90

HSPF2: Up to 10.90

COP: Up to 4.94

ENERGY STAR®: Most systems



3D i-see Sensor®

The PLA Model comes equipped with a 3D i-see Sensor, an infrared-ray sensor that measures temperatures at different positions throughout the space. This technology enables the user to personalize comfort by selecting their preferred airflow setting.



Horizontal Airflow

The PLA includes the Draft Reduction vane setting which adjusts airflow direction more horizontal than the standard vane setting, reducing drafts dramatically. *The draft reduction can be set for only 1 vane. PAR-40MAAU is required for this setting.

PLA Model Selection

Indoor Unit

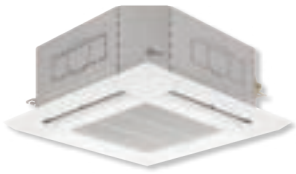

PLA-A12/18/24/30/36/42EA7

Required grille: PLP-41EAEU

Outdoor Units

Cooling Only



PUY-A12/18NKA7



PUY-A24/30NHA7



PUY-A36/42NKA7

Heat Pumps



PUZ-A12/18NKA7



PUZ-A24/30NHA7



PUZ-A36/42NKA7

Hyper-heating Heat Pumps



PUZ-HA24NH1

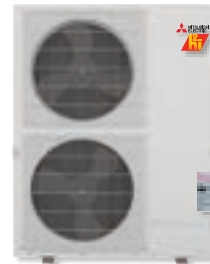

PUZ-HA30/36NKA



PUZ-HA42NK1

Optional Remote Controllers



PAR-40MAAU



PAC-YT53CRAU-J



PAR-CT01MAU-SB



PAC-SDW01RC-1



MHK2



PLA Specifications



Cooling Only

Indoor Unit			PLA-A12EA7	PLA-A18EA7	PLA-A24EA7	PLA-A30EA7	PLA-A36EA7	PLA-A42EA7	
Outdoor Unit			PUY-A12NKA7	PUY-A18NKA7	PUY-A24NHA7	PUY-A30NHA7	PUY-A36NKA7	PUY-A42NKA7	
AHRI Certified Reference Number			206716974	206716973	209447968	209447972	209447974	209447976	
Cooling	Capacity	Rated ¹	BTU/H	12,000	18,000	24,000	30,000	36,000	42,000
	Capacity Range	Min-Max	BTU/H	5,800–12,000	8,000–18,000	10,000–24,000	9,000–30,000	16,000–36,000	16,000–42,000
	Power Input	Rated ¹	W	730	1,250	1,670	2,540	2,780	3,590
	Moisture Removal	Pints/h		1.2	2.4	3.0	5.4	4.5	7.9
	Sensible Heat Factor			0.890	0.850	0.860	0.800	0.860	0.790
Sensible Heat Factor - High Latent			20	20	20	20	20	20	
Heating	Capacity at 47°F	Rated ²	BTU/H	—	—	—	—	—	—
	Capacity Range	Min-Max	BTU/H	—	—	—	—	—	—
	Power Input at 47°F	Rated ²	W	—	—	—	—	—	—
	Capacity at 17°F	Rated ³	BTU/H	—	—	—	—	—	—
		Max	BTU/H	—	—	—	—	—	—
	Capacity at 5°F	Max ⁴	BTU/H	—	—	—	—	—	—
Efficiency	SEER2			21.3	20.2	16.5	14.5	15.0	14.3
	EER2			13.3	10.7	12.0	9.5	10.5	9.0
	HSPF2			—	—	—	—	—	—
	COP			—	—	—	—	—	—
Indoor Unit	Air Flow Rate - Cooling (Quiet-Lo-Med-High-SHigh)	Dry	CFM	420–460–490–530	460–490–570–600	530–640–710–810	570–670–780–880	670–850–1020–1200	740–920–1060–1200
		Wet	CFM	380–420–450–490	380–420–530–560	490–600–670–770	530–630–740–840	630–810–980–1160	700–880–1020–1160
	Air Flow Rate - Heating (Quiet-Lo-Med-High-SHigh)	Dry	CFM	420–460–490–530	420–460–570–600	530–640–710–810	570–670–780–880	670–850–1020–1200	740–920–1060–1200
	Sound Pressure Level (Quiet-Lo-Med-High-SHigh)	Cooling	dB(A)	27–28–29–30	28–29–31–32	28–30–33–36	28–32–35–38	32–37–41–44	34–38–42–45
		Heating	dB(A)	27–28–29–30	28–29–31–32	28–30–33–36	28–32–35–38	32–37–41–44	34–38–42–45
	External Static Pressure	In. W.G.		—	—	—	—	—	—
	Condensate Lift Mechanism	Max Distance	In. [mm]	33-7/16 [849]	33-7/16 [849]	33-7/16 [849]	33-7/16 [849]	33-7/16 [849]	33-7/16 [849]
	Dimensions	H	In. [mm]	10-5/32 // 1-9/16 [258 // 40]	10-5/32 // 1-9/16 [258 // 40]	11-3/4 // 1-9/16 [298 // 40]	11-3/4 // 1-9/16 [298 // 40]	11-3/4 // 1-9/16 [298 // 40]	11-3/4 // 1-9/16 [298 // 40]
		W	In. [mm]	33-1/16 // 37-13/32 [840 // 950]	33-1/16 // 37-13/32 [840 // 950]	33-1/16 // 37-13/32 [840 // 950]	33-1/16 // 37-13/32 [840 // 950]	33-1/16 // 37-13/32 [840 // 950]	33-1/16 // 37-13/32 [840 // 950]
		D	In. [mm]	33-1/16 // 37-13/32 [840 // 950]	33-1/16 // 37-13/32 [840 // 950]	33-1/16 // 37-13/32 [840 // 950]	33-1/16 // 37-13/32 [840 // 950]	33-1/16 // 37-13/32 [840 // 950]	33-1/16 // 37-13/32 [840 // 950]
Weight	lbs [kg]		46 // 11 [21 // 5]	46 // 11 [21 // 5]	56 // 11 [25 // 5]	56 // 11 [25 // 5]	56 // 11 [25 // 5]	56 // 11 [25 // 5]	
Outdoor Unit	MCA	A		11.0	11.0	19.0	19.0	25.0	25.0
	MOCP	A		28	28	26	26	31	31
	Dimensions	H	In. [mm]	24-13/16 [630]	24-13/16 [630]	37-1/8 [943]	37-1/8 [943]	52-11/16 [1338]	52-11/16 [1338]
		W	In. [mm]	31-13/16 (+2-7/16) [809 (+62)]	31-13/16 (2+7/16) [809 (+62)]	37-13/32 [950]	37-13/32 [950]	41-5/16 [1050]	41-5/16 [1050]
		D	In. [mm]	11-13/16 [300]	11-13/16 [300]	13 (+1-3/16) [330 (+30)]	13 (+1-3/16) [330 (+30)]	13 (+1-3/16) [330 (+30)]	13 (+1-3/16) [330 (+30)]
	Weight	lbs [kg]		92 [41]	99 [44]	151 [68]	151 [68]	211 [96]	211 [96]
	Air Flow Rate (Cooling/Heating)	CFM		1590/—	1590/—	1940/—	1940/—	3880/—	3880/—
Sound Pressure Level	Cooling	dB(A)	44	44	47	47	52	52	
	Heating	dB(A)	—	—	—	—	—	—	
Piping	Diameter	Gas (O.D.)	In. [mm]	1/2 [12.7]	1/2 [12.7]	5/8 [15.88]	5/8 [15.88]	5/8 [15.88]	5/8 [15.88]
		Liquid (O.D)	In. [mm]	1/4 [6.35]	1/4 [6.35]	3/8 [9.52]	3/8 [9.52]	3/8 [9.52]	3/8 [9.52]
		Indoor Drain	In. [mm]	1-1/4 [32]	1-1/4 [32]	1-1/4 [32]	1-1/4 [32]	1-1/4 [32]	1-1/4 [32]
	Max. Length	ft [m]		165 [50]	165 [50]	225 [68]	225 [68]	225 [68]	225 [68]
Max. Height	ft [m]		100 [30]	100 [30]	100 [30]	100 [30]	100 [30]	100 [30]	
Electrical	Outdoor-Indoor ⁵	V, ph, Hz		208/230, 1, 60	208/230, 1, 60	208/230, 1, 60	208/230, 1, 60	208/230, 1, 60	208/230, 1, 60
	Recommended Breaker Size	A		15	15	25	25	30	30
Refrigerant Type			R410A	R410A	R410A	R410A	R410A	R410A	
Guaranteed Temperature Operation Range	Cooling ⁶	°F DB [°C DB]		-40 to 115 [-40.0 to 46.0]	-40 to 115 [-40.0 to 46.0]	-40 to 115 [-40.0 to 46.0]	-40 to 115 [-40.0 to 46.0]	-40 to 115 [-40.0 to 46.0]	-40 to 115 [-40.0 to 46.0]
	Heating	°F DB [°C DB]		—	—	—	—	—	—

Notes:
 AHRI Rated Conditions ¹Cooling (Indoor // Outdoor) ⁴F 80 DB, 67 WB // 95 DB, 75 WB

(Rated data is determined at a fixed compressor speed)

⁵Indoor units receive power from outdoor units through field-supplied interconnected wiring.

⁶Wind baffles required to operate below 23°F DB in cooling mode. PUY with wind baffle: -40°F - 115°F. Refer to wind baffle documentation for further information.

SEACOAST PROTECTION

- External Outer Panel: Phosphate coating + Acrylic-Enamel coating
- Fan Motor Support: Epoxy resin coating (at edge face)
- Separator Assembly, Valve Bed: Epoxy resin coating (at edge face)
- "Blue Fin" treatment is an anti-corrosion treatment that is applied to the condenser coil to protect it against airborne contaminants.

PLA Specifications



Heat Pump

Indoor Unit			PLA-A12EA7	PLA-A18EA7	PLA-A24EA7	PLA-A30EA7	PLA-A36EA7	PLA-A42EA7	
Outdoor Unit			PUZ-A12NKA7	PUZ-A18NKA7	PUZ-A24NHA7	PUZ-A30NHA7	PUZ-A36NKA7	PUZ-A42NKA7	
AHRI Certified Reference Number			206716978	206716983	209447978	209447982	209447984	209447986	
Cooling	Capacity	Rated ¹	BTU/H	12,000	18,000	24,000	30,000	36,000	42,000
	Capacity Range	Min-Max	BTU/H	5,800–12,000	8,000–18,000	10,000–24,000	9,000–30,000	16,000–36,000	16,000–42,000
	Power Input	Rated ¹	W	730	1,250	1,670	2,540	2,780	3,590
	Moisture Removal	Pints/h		1.2	2.4	3.0	5.4	4.5	7.9
	Sensible Heat Factor			0.890	0.850	0.860	0.800	0.860	0.790
	Sensible Heat Factor - High Latent			20	20	20	20	20	20
Heating	Capacity at 47°F	Rated ²	BTU/H	14,000	19,000	26,000	32,000	38,000	45,000
	Capacity Range	Min-Max	BTU/H	5,500–20,000	7,900–23,000	9,000–29,000	9,000–33,000	18,000–42,000	18,000–48,000
	Power Input at 47°F	Rated ²	W	830	1,300	1,750	2,400	2,540	3,290
	Capacity at 17°F	Rated ³	BTU/H	10,100	11,000	14,900	18,100	22,000	28,000
		Max	BTU/H	12,200	13,500	17,400	20,800	25,500	30,800
	Capacity at 5°F	Max ⁴	BTU/H	—	—	13,000	16,800	21,600	26,900
Efficiency	SEER2			21.3	20.2	16.5	14.5	15.0	14.3
	EER2			13.3	10.7	12.0	9.5	10.5	9.0
	HSPF2			10.2	9.2	9.0	9.0	8.5	8.5
	COP			4.94	4.28	4.35	3.9	4.38	4.0
	Air Flow Rate - Cooling (Quiet-Lo-Med-High-SHigh)	Dry	CFM	420–460–490–530	460–490–570–600	530–640–710–810	570–670–780–880	670–850–1020–1200	740–920–1060–1200
	Wet	CFM	380–420–450–490	380–420–530–560	490–600–670–770	530–630–740–840	630–810–980–1160	700–880–1020–1160	
Air Flow Rate - Heating (Quiet-Lo-Med-High-SHigh)	Dry	CFM	420–460–490–530	420–460–570–600	530–640–710–810	570–670–780–880	670–850–1020–1200	740–920–1060–1200	
Sound Pressure Level (Quiet-Lo-Med-High-SHigh)	Cooling	dB(A)	27–28–29–30	28–29–31–32	28–30–33–36	28–32–35–38	32–37–41–44	34–38–42–45	
	Heating	dB(A)	27–28–29–30	28–29–31–32	28–30–33–36	28–32–35–38	32–37–41–44	34–38–42–45	
External Static Pressure		In. W.G.	—	—	—	—	—	—	
Condensate Lift Mechanism	Max Distance	In. [mm]	33-7/16 [849]	33-7/16 [849]	33-7/16 [849]	33-7/16 [849]	33-7/16 [849]	33-7/16 [849]	
Dimensions	H	In. [mm]	10-5/32 // 1-9/16 [258 // 40]	10-5/32 // 1-9/16 [258 // 40]	11-3/4 // 1-9/16 [298 // 40]	11-3/4 // 1-9/16 [298 // 40]	11-3/4 // 1-9/16 [298 // 40]	11-3/4 // 1-9/16 [298 // 40]	
	W	In. [mm]	33-1/16 // 37-13/32 [840 // 950]	33-1/16 // 37-13/32 [840 // 950]	33-1/16 // 37-13/32 [840 // 950]	33-1/16 // 37-13/32 [840 // 950]	33-1/16 // 37-13/32 [840 // 950]	33-1/16 // 37-13/32 [840 // 950]	
	D	In. [mm]	33-1/16 // 37-13/32 [840 // 950]	33-1/16 // 37-13/32 [840 // 950]	33-1/16 // 37-13/32 [840 // 950]	33-1/16 // 37-13/32 [840 // 950]	33-1/16 // 37-13/32 [840 // 950]	33-1/16 // 37-13/32 [840 // 950]	
	Weight	lbs [kg]		46 // 11 [21 // 5]	46 // 11 [21 // 5]	56 // 11 [25 // 5]	56 // 11 [25 // 5]	56 // 11 [25 // 5]	56 // 11 [25 // 5]
Outdoor Unit	MCA	A		11.0	11.0	19.0	19.0	25.0	25.0
	MOCP	A		28	28	26	26	31	31
	Dimensions	H	In. [mm]	24-13/16 [630]	24-13/16 [630]	37-1/8 [943]	37-1/8 [943]	52-11/16 [1338]	52-11/16 [1338]
		W	In. [mm]	31-13/16 (2+7/16) [809 (+62)]	31-13/16 (2+7/16) [809 (+62)]	37-13/32 [950]	37-13/32 [950]	41-5/16 [1050]	41-5/16 [1050]
		D	In. [mm]	11-13/16 [300]	11-13/16 [300]	13 (+1-3/16) [330 (+30)]	13 (+1-3/16) [330 (+30)]	13 (+1-3/16) [330 (+30)]	13 (+1-3/16) [330 (+30)]
	Weight	lbs [kg]		93 [42]	100 [45]	153 [69]	153 [69]	214 [97]	214 [97]
	Air Flow Rate (Cooling/Heating)	CFM		1590/1590	1590/1590	1940/1940	1940/1940	3880/3880	3880/3880
Sound Pressure Level	Cooling	dB(A)	44	44	47	47	52	52	
	Heating	dB(A)	46	46	48	48	53	53	
Piping	Diameter	Gas (O.D.)	In. [mm]	1/2 [12.7]	1/2 [12.7]	5/8 [15.88]	5/8 [15.88]	5/8 [15.88]	5/8 [15.88]
		Liquid (O.D.)	In. [mm]	1/4 [6.35]	1/4 [6.35]	3/8 [9.52]	3/8 [9.52]	3/8 [9.52]	3/8 [9.52]
		Indoor Drain	In. [mm]	1-1/4 [32]	1-1/4 [32]	1-1/4 [32]	1-1/4 [32]	1-1/4 [32]	1-1/4 [32]
	Max. Length	ft [m]		100 [30]	100 [30]	165 [50]	165 [50]	165 [50]	165 [50]
Max. Height	ft [m]		100 [30]	100 [30]	100 [30]	100 [30]	100 [30]	100 [30]	
Electrical	Outdoor-Indoor ⁵	V, ph, Hz		208/230, 1, 60	208/230, 1, 60	208/230, 1, 60	208/230, 1, 60	208/230, 1, 60	208/230, 1, 60
	Recommended Breaker Size	A		15	15	25	25	30	30
Refrigerant Type				R410A	R410A	R410A	R410A	R410A	R410A
Guaranteed Temperature Operation Range	Cooling ⁶	°F DB [°C DB]		0 to 115 [-18.0 to 46.0]	0 to 115 [-18.0 to 46.0]	0 to 115 [-18.0 to 46.0]	0 to 115 [-18.0 to 46.0]	0 to 115 [-18.0 to 46.0]	0 to 115 [-18.0 to 46.0]
		Heating	°F DB [°C DB]		12 to 70 [-11.0 to 21.0]	12 to 70 [-11.0 to 21.0]	-4 to 70 [-20.0 to 21.0]	-4 to 70 [-20.0 to 21.0]	-4 to 70 [-20.0 to 21.0]

Notes:
 AHRI Rated Conditions
 (Rated data is determined at a fixed compressor speed)
 Conditions
¹Cooling (Indoor // Outdoor) °F 80 DB, 67 WB // 95 DB, 75 WB
²Heating at 47°F (Indoor // Outdoor) °F 70 DB, 60 WB // 47 DB, 43 WB
³Heating at 17°F (Indoor // Outdoor) °F 70 DB, 60 WB // 17 DB, 15 WB
⁴Heating at 5°F (Indoor // Outdoor) °F 70 DB, 60 WB // 5 DB, 4 WB
⁵Indoor units receive power from outdoor units through field-supplied interconnected wiring.
⁶Wind baffles required to operate below 23°F DB in cooling mode. PUZ with wind baffle: 0° F - 115° F. Refer to wind baffle documentation for further information.
 SEACOAST PROTECTION
 • External Outer Panel: Phosphate coating + Acrylic-Enamel coating
 • Fan Motor Support: Epoxy resin coating (at edge face)
 • Separator Assembly; Valve Bed: Epoxy resin coating (at edge face)
 • "Blue Fin" treatment is an anti-corrosion treatment that is applied to the condenser coil to protect it against airborne contaminants.

PLA Specifications



Hyper-heating Heat Pump

Indoor Unit			PLA-A24EA7	PLA-A30EA7	PLA-A36EA7	PLA-A42EA7	
Outdoor Unit			PUZ-HA24NHA1	PUZ-HA30NKA	PUZ-HA36NKA	PUZ-HA42NKA1	
AHRI Certified Reference Number			206223004	206223005	211259275	206223007	
Cooling	Capacity	Rated ¹	BTU/H	24,000	30,000	36,000	42,000
	Capacity Range	Min-Max	BTU/H	10,000–24,000	14,600–30,000	14,800–36,000	18,800–42,000
	Power Input	Rated ¹	W	1,710	2,120	2,750	3,920
	Moisture Removal	Pints/h		3.0	5.4	5.5	4.5
	Sensible Heat Factor			0.860	0.800	0.830	0.880
	Sensible Heat Factor - High Latent			20	20	20	20
Heating	Capacity at 47°F	Rated ²	BTU/H	26,000	32,000	38,000	48,000
	Capacity Range	Min-Max	BTU/H	10,000–28,000	14,200–34,000	16,700–40,000	17,000–54,000
	Power Input at 47°F	Rated ²	W	1,700	2,260	2,650	4,210
	Capacity at 17°F	Rated ³	BTU/H	17,300	20,600	24,200	40,500
		Max	BTU/H	26,000	32,000	38,000	48,000
	Capacity at 5°F	Max ⁴	BTU/H	26,000	32,000	38,000	48,000
	Capacity at -5°F	Max ⁵	BTU/H	—	—	—	—
Efficiency	SEER2			21.6	20.2	20.0	16.3
	EER2			14.0	14.1	13.0	10.7
	HSPF2			10.0	8.8	9.0	9.0
	COP			4.5	4.1	4.2	3.3
	Air Flow Rate - Cooling (Quiet-Lo-Med-High-SHigh)	Dry	CFM	530–640–710–810	570–670–780–880	670–850–1020–1200	740–920–1060–1200
	Wet	CFM	490–600–670–770	530–630–740–840	630–810–980–1160	700–880–1020–1160	
Air Flow Rate - Heating (Quiet-Lo-Med-High-SHigh)	Dry	CFM	530–640–710–810	570–670–780–880	670–850–1020–1200	740–920–1060–1200	
Sound Pressure Level (Quiet-Lo-Med-High-SHigh)	Cooling	dB(A)	28–30–33–36	28–32–35–38	32–37–41–44	34–38–42–45	
	Heating	dB(A)	28–30–33–36	28–32–35–38	32–37–41–44	34–38–42–45	
External Static Pressure		In. W.G.	—	—	—	—	
Condensate Lift Mechanism	Max Distance	In. [mm]	33-7/16 [849]	33-7/16 [849]	33-7/16 [849]	33-7/16 [849]	
Dimensions	H	In. [mm]	11-3/4 // 1-9/16 [298 // 40]	11-3/4 // 1-9/16 [298 // 40]	11-3/4 // 1-9/16 [298 // 40]	11-3/4 // 1-9/16 [298 // 40]	
	W	In. [mm]	33-1/16 // 37-13/32 [840 // 950]	33-1/16 // 37-13/32 [840 // 950]	33-1/16 // 37-13/32 [840 // 950]	33-1/16 // 37-13/32 [840 // 950]	
	D	In. [mm]	33-1/16 // 37-13/32 [840 // 950]	33-1/16 // 37-13/32 [840 // 950]	33-1/16 // 37-13/32 [840 // 950]	33-1/16 // 37-13/32 [840 // 950]	
Weight	lbs [kg]		56 // 11 [25 // 5]	56 // 11 [25 // 5]	56 // 11 [25 // 5]	56 // 11 [25 // 5]	
Outdoor Unit	MCA	A		17.0	24.0	24.0	36.0
	MOCP	A		27	40	40	44
	Dimensions	H	In. [mm]	37-1/8 [943]	52-11/16 [1338]	52-11/16 [1338]	52-11/16 [1338]
		W	In. [mm]	37-13/32 [950]	41-5/16 [1050]	41-5/16 [1050]	41-5/16 [1050]
		D	In. [mm]	14-3/16 [360]	14-3/16 [360]	14-3/16 [360]	14-3/16 [360]
	Weight	lbs [kg]		190 [86]	261 [118]	261 [118]	283 [128]
	Air Flow Rate (Cooling/Heating)	CFM		1940/1940	3880/3880	3880/3880	3319/3319
	Sound Pressure Level	Cooling	dB(A)	52	52	52	49
		Heating	dB(A)	53	53	53	51
	Piping	Diameter	Gas (O.D.)	In. [mm]	5/8 [15.88]	5/8 [15.88]	5/8 [15.88]
Liquid (O.D.)			In. [mm]	3/8 [9.52]	3/8 [9.52]	3/8 [9.52]	3/8 [9.52]
Indoor Drain			In. [mm]	1-1/4 [32]	1-1/4 [32]	1-1/4 [32]	1-1/4 [32]
Max. Length		ft [m]		165 [50]	245 [75]	245 [75]	245 [75]
Max. Height	ft [m]		100 [30]	100 [30]	100 [30]	100 [30]	
Electrical	Outdoor-Indoor ⁵	V, ph, Hz		208/230, 1, 60	208/230, 1, 60	208/230, 1, 60	208/230, 1, 60
	Recommended Breaker Size	A		25	35	35	40
Refrigerant Type			R410A				
Guaranteed Temperature Operation Range	Cooling ⁶	°F DB [°C DB]		0 to 115 [-18.0 to 46.0]	0 to 115 [-18.0 to 46.0]	0 to 115 [-18.0 to 46.0]	0 to 115 [-18.0 to 46.0]
	Heating	°F DB [°C DB]		-13 to 70 [-25.0 to 21.0]	-13 to 70 [-25.0 to 21.0]	-13 to 70 [-25.0 to 21.0]	-13 to 70 [-25.0 to 21.0]

Notes:

- AHRI Rated Conditions (Rated data is determined at a fixed compressor speed)
 - ¹Cooling (Indoor // Outdoor) °F 80 DB, 67 WB // 95 DB, 75 WB
 - ²Heating at 47°F (Indoor // Outdoor) °F 70 DB, 60 WB // 47 DB, 43 WB
 - ³Heating at 17°F (Indoor // Outdoor) °F 70 DB, 60 WB // 17 DB, 15 WB
 - ⁴Heating at 5°F (Indoor // Outdoor) °F 70 DB, 60 WB // 5 DB, 4 WB
- ⁵Indoor units receive power from outdoor units through field-supplied interconnected wiring.
- ⁶Wind baffles required to operate below 23°F DB in cooling mode. PUZ with wind baffle: 0° F - 115° F.



PKA

Wall-mounted Indoor Unit



Wall-mounted Indoor Unit

The PKA Wall-mounted indoor unit features a sleek, compact design ideal for spaces such as daycare centers, classrooms, churches, small offices, and more. Offers selectable High Sensible vs High Latent mode for the 12,000 and 18,000 capacity units.

Capacities: 12,000 to 36,000 BTU/H

Sound: As low as 34 dB(A)

SEER2: Up to 21.30

HSPF2: Up to 10.20

COP: Up to 4.52

ENERGY STAR®: Some systems

Sleek Design

The PKA Wall-mounted indoor unit features a sleek, compact design ideal for spaces such as daycare centers, classrooms, churches, small offices, and more. A flat panel design and pure white color pairs with any interior.



Improved Energy Efficiency

Energy-saving efficiency has been improved, reducing electricity consumption and contributing to a further reduction in operating cost. When contrasted with the previous model's performance, SEER and HSPF efficiencies improved, realizing industry-leading energy-saving features.

PKA Model Selection



Indoor Unit



PKA-LA



PKA-KA

Outdoor Units

Cooling Only



PUY-A12/18NKA7



PUY-A24/30NHA7



PUY-A36/42NKA7

Heat Pumps



PUZ-A12/18NKA7



PUZ-A24/30NHA7



PUZ-A36/42NKA7

Hyper-heating Heat Pumps



PUZ-HA24NH1



PUZ-HA30/36NKA

Optional Remote Controllers



PAR-40MAAU



PAC-YT53CRAU-J



PAR-CT01MAU-SB



PAC-SDW01RC-1



MHK2



PKA Specifications



Heat Pump

Indoor Unit			PKA-A12LA	PKA-A18LA	PKA-A24KA7	PKA-A30KA7	PKA-A36KA7	
Outdoor Unit			PUZ-A12NKA7	PUZ-A18NKA7	PUZ-A24NHA7	PUZ-A30NHA7	PUZ-A36NKA7	
AHRI Certified Reference Number			206716978	206716983	209447978	209447982	209447984	
Cooling	Capacity	Rated ¹	BTU/H	12,000	18,000	24,000	30,000	36,000
	Capacity Range	Min-Max	BTU/H	4,400–12,000	5,600–18,000	10,000–24,000	9,000–30,000	16,000–36,000
	Power Input	Rated ¹	W	900	1,680	1,960	3,150	3,330
	Moisture Removal		Pints/h	2.7	5.8	5.0	8.1	9.7
	Sensible Heat Factor			0.880	0.730	0.770	0.700	0.700
	Sensible Heat Factor - High Latent			0.75	0.64	20	20	20
Heating	Capacity at 47°F	Rated ²	BTU/H	14,000	19,000	26,000	32,000	38,000
	Capacity Range	Min-Max	BTU/H	4,400–18,000	5,400–22,000	9,000–28,000	8,900–34,000	18,200–40,000
	Power Input at 47°F	Rated ²	W	1,030	1,640	1,750	2,460	2,460
	Capacity at 17°F	Rated ³	BTU/H	10,600	13,600	15,700	18,300	22,400
		Max	BTU/H	10,600	13,600	18,300	21,000	25,900
	Capacity at 5°F	Max ⁴	BTU/H	—	—	15,200	—	—
	Capacity at -5°F	Max ⁵	BTU/H	—	—	—	—	—
Efficiency	SEER2			21.3	20.2	16.5	14.5	15.0
	EER2			13.3	10.7	12.0	9.5	10.5
	HSPF2			10.2	9.2	9.0	9.0	8.5
	COP			3.9	3.4	4.35	3.81	4.52
	Air Flow Rate - Cooling (Quiet-Lo-Med-High-SHigh)	Dry	CFM	265–310–385–455	265–310–385–455	635–705–775	635–705–775	705–810–920
	Wet	CFM	215–255–320–375	215–255–320–375	570–635–700	570–635–700	635–730–830	
Air Flow Rate - Heating (Quiet-Lo-Med-High-SHigh)	Dry	CFM	265–290–325–385	265–310–385–455	635–705–775	635–705–775	705–810–920	
Sound Pressure Level (Quiet-Lo-Med-High-SHigh)	Cooling	dB(A)	34–39–44–48	34–39–44–48	39–42–45	39–42–45	43–46–49	
	Heating	dB(A)	34–37–40–43	34–37–40–43	39–42–45	39–42–45	43–46–49	
External Static Pressure		In. W.G.	—	—	—	—	—	
Condensate Lift Mechanism	Max Distance	In. [mm]	19-11/16 [850]	19-11/16 [850]	—	—	—	
Dimensions	H	In. [mm]	11-25/32 [299]	11-25/32 [299]	14-3/8 [365]	14-3/8 [365]	14-3/8 [365]	
	W	In. [mm]	35-23/64 [898]	35-23/64 [898]	46-1/16 [1170]	46-1/16 [1170]	46-1/16 [1170]	
	D	In. [mm]	9-11/32 [237]	9-11/32 [237]	11-5/8 [295]	11-5/8 [295]	11-5/8 [295]	
	Weight	lbs [kg]	28 [12.7]	28 [12.7]	46 [21]	46 [21]	46 [21]	
Outdoor Unit	MCA	A	11.0	11.0	19.0	19.0	25.0	
	MOC	A	28	28	26	26	31	
	Dimensions	H	In. [mm]	24-13/16 [630]	24-13/16 [630]	37-1/8 [943]	37-1/8 [943]	52-11/16 [1338]
		W	In. [mm]	31-13/16 (2+7/16) [809 (+62)]	31-13/16 (2+7/16) [809 (+62)]	37-13/32 [950]	37-13/32 [950]	41-5/16 [1050]
		D	In. [mm]	11-13/16 [300]	11-13/16 [300]	13 (+1-3/16) [330 (+30)]	13 (+1-3/16) [330 (+30)]	13 (+1-3/16) [330 (+30)]
	Weight	lbs [kg]	93 [42]	100 [45]	153 [69]	153 [69]	214 [97]	
	Air Flow Rate (Cooling/Heating)	CFM	1590/1590	1590/1590	1940/1940	1940/1940	3880/3880	
	Sound Pressure Level	Cooling	dB(A)	44	44	47	47	52
Heating		dB(A)	46	46	48	48	53	
Piping	Diameter	Gas (O.D.)	In. [mm]	1/2 [12.7]	1/2 [12.7]	5/8 [15.88]	5/8 [15.88]	5/8 [15.88]
		Liquid (O.D.)	In. [mm]	1/4 [6.35]	1/4 [6.35]	3/8 [9.52]	3/8 [9.52]	3/8 [9.52]
		Indoor Drain	In. [mm]	5/8 [16]	5/8 [16]	5/8 [16]	5/8 [16]	5/8 [16]
	Max. Length	ft [m]	100 [30]	100 [30]	165 [50]	165 [50]	165 [50]	
Max. Height	ft [m]	100 [30]	100 [30]	100 [30]	100 [30]	100 [30]		
Electrical	Outdoor-Indoor ⁵	V, ph, Hz	208/230, 1, 60	208/230, 1, 60	208/230, 1, 60	208/230, 1, 60	208/230, 1, 60	
	Recommended Breaker Size	A	15	15	25	25	30	
Refrigerant Type			R410A	R410A	R410A	R410A	R410A	
Guaranteed Temperature Operation Range	Cooling ⁶	°F DB [°C DB]	0 to 115 [-18.0 to 46.0]	0 to 115 [-18.0 to 46.0]	0 to 115 [-18.0 to 46.0]	0 to 115 [-18.0 to 46.0]	0 to 115 [-18.0 to 46.0]	
	Heating	°F DB [°C DB]	12 to 70 [-11.0 to 21.0]	12 to 70 [-11.0 to 21.0]	-4 to 70 [-20.0 to 21.0]	-4 to 70 [-20.0 to 21.0]	-4 to 70 [-20.0 to 21.0]	

Notes:
 AHRI Rated Conditions (Rated data is determined at a fixed compressor speed)
 Conditions
¹Cooling (Indoor // Outdoor) °F 80 DB, 67 WB // 95 DB, 75 WB
²Heating at 47°F (Indoor // Outdoor) °F 70 DB, 60 WB // 47 DB, 43 WB
³Heating at 17°F (Indoor // Outdoor) °F 70 DB, 60 WB // 17 DB, 15 WB
⁴Heating at 5°F (Indoor // Outdoor) °F 70 DB, 60 WB // 5 DB, 4 WB

⁵Indoor units receive power from outdoor units through field-supplied interconnected wiring.
⁶Wind baffles required to operate below 23°F DB in cooling mode. PUZ with wind baffle: 0° F - 115° F. Refer to wind baffle documentation for further information.

- SEACOAST PROTECTION
- External Outer Panel: Phosphate coating + Acrylic-Enamel coating
 - Fan Motor Support: Epoxy resin coating (at edge face)
 - Separator Assembly; Valve Bed: Epoxy resin coating (at edge face)
 - "Blue Fin" treatment is an anti-corrosion treatment that is applied to the condenser coil to protect it against airborne contaminants.

PKA Specifications



Hyper-heating Heat Pump

Indoor Unit				PKA-A24KA7	PKA-A30KA7	PKA-A36KA7
Outdoor Unit				PUZ-HA24NHA1	PUZ-HA30NKA	PUZ-HA36NKA
AHRI Certified Reference Number				206223004	206223005	211259275
Cooling	Capacity	Rated ¹	BTU/H	24,000	30,000	33,600
	Capacity Range	Min-Max	BTU/H	10,000–24,000	14,600–30,000	14,700–36,000
	Power Input	Rated ¹	W	1,900	2,330	2,700
	Moisture Removal	Pints/h		5.0	7.5	9.3
	Sensible Heat Factor			0.770	0.720	0.690
	Sensible Heat Factor - High Latent			—	—	—
Heating	Capacity at 47°F	Rated ²	BTU/H	26,000	32,000	38,000
	Capacity Range	Min-Max	BTU/H	10,000–28,000	14,600–34,000	14,900–40,000
	Power Input at 47°F	Rated ²	W	1,920	2,770	3,340
	Capacity at 17°F	Rated ³	BTU/H	17,200	21,300	25,400
	Capacity at 5°F	Max ⁴	BTU/H	26,000	32,000	38,000
	Capacity at -5°F	Max ⁵	BTU/H	—	—	—
Efficiency	SEER2			21.6	20.2	20.0
	EER2			14.0	14.1	13.0
	HSPF2			10.0	8.8	9.0
	COP			3.96	3.38	3.33
Indoor Unit	Air Flow Rate - Cooling (Quiet-Lo-Med-High-SHigh)	Dry	CFM	635–705–775	635–705–775	705–810–920
		Wet	CFM	570–635–700	570–635–700	635–730–830
	Air Flow Rate - Heating (Quiet-Lo-Med-High-SHigh)	Dry	CFM	635–705–775	635–705–775	705–810–920
	Sound Pressure Level (Quiet-Lo-Med-High-SHigh)	Cooling	dB(A)	39–42–45	39–42–45	43–46–49
		Heating	dB(A)	39–42–45	39–42–45	43–46–49
	External Static Pressure		In. W.G.	—	—	—
	Condensate Lift Mechanism	Max Distance	In. [mm]	—	—	—
		H	In. [mm]	14-3/8 [365]	14-3/8 [365]	14-3/8 [365]
	Dimensions	W	In. [mm]	46-1/16 [1170]	46-1/16 [1170]	46-1/16 [1170]
		D	In. [mm]	11-5/8 [295]	11-5/8 [295]	11-5/8 [295]
Outdoor Unit	Weight	lbs [kg]		46 [21]	46 [21]	46 [21]
	MCA	A		17.0	24.0	24.0
	MOCP	A		27	40	40
	Dimensions	H	In. [mm]	37-1/8 [943]	52-11/16 [1338]	52-11/16 [1338]
		W	In. [mm]	37-13/32 [950]	41-5/16 [1050]	41-5/16 [1050]
		D	In. [mm]	14-3/16 [360]	14-3/16 [360]	14-3/16 [360]
	Weight	lbs [kg]		190 [86]	261 [118]	261 [118]
	Air Flow Rate (Cooling/Heating)	CFM		1940/1940	3880/3880	3880/3880
	Sound Pressure Level	Cooling	dB(A)	52	52	52
		Heating	dB(A)	53	53	53
Piping	Diameter	Gas (O.D.)	In. [mm]	5/8 [15.88]	5/8 [15.88]	5/8 [15.88]
		Liquid (O.D.)	In. [mm]	3/8 [9.52]	3/8 [9.52]	3/8 [9.52]
		Indoor Drain	In. [mm]	5/8 [16]	5/8 [16]	5/8 [16]
	Max. Length	ft [m]		165 [50]	245 [75]	245 [75]
Max. Height	ft [m]		100 [30]	100 [30]	100 [30]	
Electrical	Outdoor-Indoor ⁵	V, ph, Hz		208/230, 1, 60	208/230, 1, 60	208/230, 1, 60
	Recommended Breaker Size	A		25	35	35
Refrigerant Type				R410A	R410A	R410A
Guaranteed Temperature Operation Range	Cooling ⁶	°F DB [°C DB]		0 to 115 [-18.0 to 46.0]	0 to 115 [-18.0 to 46.0]	0 to 115 [-18.0 to 46.0]
	Heating	°F DB [°C DB]		-13 to 70 [-25.0 to 21.0]	-13 to 70 [-25.0 to 21.0]	-13 to 70 [-25.0 to 21.0]

Notes:
 AHRI Rated Conditions
 (Rated data is determined at a fixed compressor speed)
 Conditions

¹Cooling (Indoor // Outdoor) °F 80 DB, 67 WB // 95 DB, 75 WB
²Heating at 47°F (Indoor // Outdoor) °F 70 DB, 60 WB // 47 DB, 43 WB
³Heating at 17°F (Indoor // Outdoor) °F 70 DB, 60 WB // 17 DB, 15 WB
⁴Heating at 5°F (Indoor // Outdoor) °F 70 DB, 60 WB // 5 DB, 4 WB

⁵Indoor units receive power from outdoor units through field-supplied interconnected wiring.
⁶Wind baffles required to operate below 23°F DB in cooling mode. PUZ with wind baffle: 0° F - 115° F.



PVA

Air Handler Indoor Unit



Multi-position Air Handler

The PVA Multi-position Air Handler boasts best-in-class construction with the highly efficient EC motor that features three different static pressure settings. Optional electric heat kits are available. This air handler unit features a built-in humidifier, ERV, and auxiliary heat control inputs.

Capacities: 12,000 to 42,000 BTU/H

Sound: As low as 24 dB(A)

SEER2: Up to 22.00

HSPF2: Up to 10.00

COP: Up to 4.10

ENERGY STAR®: Some systems

Versatile Positions

The PVA Model air handler, part of the Intelli-AIR™ family, is multi-positional, offering up, down, left, or right airflow options, making it ideal for tight and unique spaces. (*CMA accessory recommended for downflow applications.) The PVA is an ideal solution for projects requiring a longer distance between the air handler and the outdoor unit.

Interlocking Function

The PVA Model has an output terminal which allows it to interlock with other appliances such as humidifiers and dehumidifiers.

PVA Model Selection



Indoor Unit



PVA-A12/18/24/30/36/42AA7

Outdoor Units

Cooling Only

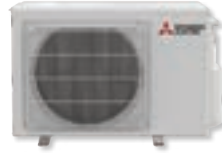

PUY-A12/18NKA7



PUY-A24/30NHA7



PUY-A36/42NKA7

Heat Pumps



PUZ-A12/18NKA7



PUZ-A24/30NHA7



PUZ-A36/42NKA7

Hyper-heating Heat Pumps



PUZ-HA24NH1



PUZ-HA30/36NKA



PUZ-HA42NK1

Optional Remote Controllers



PAR-40MAAU



PAC-YT53CRAU-J



PAR-CT01MAU-SB



PAC-SDW01RC-1



MHK2



PVA Specifications



Heat Pump

Indoor Unit			PVA-A12AA7	PVA-A18AA7	PVA-A24AA7	PVA-A30AA7	PVA-A36AA7	PVA-A42AA7	
Outdoor Unit			PUZ-A12NKA7	PUZ-A18NKA7	PUZ-A24NHA7	PUZ-A30NHA7	PUZ-A36NKA7	PUZ-A42NKA7	
AHRI Certified Reference Number			206716978	206716983	209447978	209447982	209447984	209447986	
Cooling	Capacity	Rated ¹	BTU/H	12,000	18,000	24,000	30,000	36,000	42,000
	Capacity Range	Min-Max	BTU/H	4,800–12,000	7,000–18,000	10,000–24,000	10,000–30,000	14,600–36,000	15,000–42,000
	Power Input	Rated ¹	W	890	1,570	1,960	3,000	3,250	4,150
	Moisture Removal		Pints/h	1.2	2.4	3.0	5.4	4.5	7.9
	Sensible Heat Factor			0.770	0.760	0.830	0.740	0.770	0.810
Sensible Heat Factor - High Latent				20	20	20	20	20	
Heating	Capacity at 47°F	Rated ²	BTU/H	14,000	19,000	26,000	32,000	38,000	46,000
	Capacity Range	Min-Max	BTU/H	5,700–19,000	7,700–23,000	12,000–28,000	12,000–34,000	17,700–42,000	18,100–48,000
	Power Input at 47°F	Rated ²	W	1,070	1,470	1,920	2,640	3,030	3,900
	Capacity at 17°F	Rated ³	BTU/H	9,900	12,000	15,000	18,000	24,000	28,400
	Capacity at 5°F	Max ⁴	BTU/H	—	—	14,500	17,200	23,900	26,800
	Capacity at -5°F	Max ⁵	BTU/H	—	—	—	—	—	—
Efficiency	SEER2			21.3	20.2	16.5	14.5	15.0	14.3
	EER2			13.3	10.7	12.0	9.5	10.5	9.0
	HSPF2			10.2	9.2	9.0	9.0	8.5	8.5
	COP			3.82	3.78	3.96	3.54	3.66	3.44
Indoor Unit	Air Flow Rate - Cooling (Quiet-Lo-Med-High-SHigh)	Dry	CFM	280–340–400	515–625–735	613–744–875	613–744–875	788–956–1125	1040–1262–1485
		Wet	CFM	—	—	—	—	—	—
	Air Flow Rate - Heating (Quiet-Lo-Med-High-SHigh)	Dry	CFM	280–340–400	515–625–735	613–744–875	613–744–875	788–956–1125	1040–1262–1485
	Sound Pressure Level (Quiet-Lo-Med-High-SHigh)	Cooling	dB(A)	27–31–35	28–33–36	30–34–38	30–34–38	30–34–38	36–40–44
		Heating	dB(A)	27–31–35	28–33–36	30–34–38	30–34–38	30–34–38	36–40–44
	External Static Pressure		In. W.G.	0.30–0.5–0.8	0.30–0.5–0.8	0.30–0.5–0.8	0.30–0.5–0.8	0.30–0.5–0.8	0.30–0.5–0.8
	Condensate Lift Mechanism	Max Distance	In. [mm]	—	—	—	—	—	—
	Dimensions	H	In. [mm]	50-1/4 [1275]	50-1/4 [1275]	54-1/4 [1378]	54-1/4 [1378]	59-1/2 [1511]	59-1/2 [1511]
		W	In. [mm]	17 [432]	17 [432]	21 [534]	21 [534]	25 [635]	25 [635]
		D	In. [mm]	21-5/8 [548]	21-5/8 [548]	21-5/8 [548]	21-5/8 [548]	21-5/8 [548]	21-5/8 [548]
Weight		lbs [kg]	113 [51]	113 [51]	141 [64]	141 [64]	172 [78]	172 [78]	
Outdoor Unit	MCA	A		11.0	11.0	19.0	19.0	25.0	25.0
	MOCP	A		28	28	26	26	31	31
	Dimensions	H	In. [mm]	24-13/16 [630]	24-13/16 [630]	37-1/8 [943]	37-1/8 [943]	52-11/16 [1338]	52-11/16 [1338]
		W	In. [mm]	31-13/16 (2+7/16) [809 (+62)]	31-13/16 (2+7/16) [809 (+62)]	37-13/32 [950]	37-13/32 [950]	41-5/16 [1050]	41-5/16 [1050]
		D	In. [mm]	11-13/16 [300]	11-13/16 [300]	13 (+1-3/16) [330 (+30)]	13 (+1-3/16) [330 (+30)]	13 (+1-3/16) [330 (+30)]	13 (+1-3/16) [330 (+30)]
	Weight		lbs [kg]	93 [42]	100 [45]	153 [69]	153 [69]	214 [97]	214 [97]
	Air Flow Rate (Cooling/Heating)		CFM	1590/1590	1590/1590	1940/1940	1940/1940	3880/3880	3880/3880
	Sound Pressure Level	Cooling	dB(A)	44	44	47	47	52	52
Heating		dB(A)	46	46	48	48	53	53	
Piping	Diameter	Gas (O.D.)	In. [mm]	1/2 [12.7]	1/2 [12.7]	5/8 [15.88]	5/8 [15.88]	5/8 [15.88]	5/8 [15.88]
		Liquid (O.D.)	In. [mm]	1/4 [6.35]	1/4 [6.35]	3/8 [9.52]	3/8 [9.52]	3/8 [9.52]	3/8 [9.52]
		Indoor Drain	In. [mm]	3/4 FPT [19.05]	3/4 FPT [19.05]	3/4 FPT [19.05]	3/4 FPT [19.05]	3/4 FPT [19.05]	3/4 FPT [19.05]
	Max. Length		ft [m]	100 [30]	100 [30]	165 [50]	165 [50]	165 [50]	165 [50]
Max. Height		ft [m]	100 [30]	100 [30]	100 [30]	100 [30]	100 [30]	100 [30]	
Electrical	Outdoor-Indoor ⁵	V, ph, Hz		208/230, 1, 60	208/230, 1, 60	208/230, 1, 60	208/230, 1, 60	208/230, 1, 60	208/230, 1, 60
	Recommended Breaker Size	A		15	15	25	25	30	30
Refrigerant Type				R410A	R410A	R410A	R410A	R410A	R410A
Guaranteed Temperature Operation Range	Cooling ⁶	°F DB [°C DB]		0 to 115 [-18.0 to 46.0]	0 to 115 [-18.0 to 46.0]	0 to 115 [-18.0 to 46.0]	0 to 115 [-18.0 to 46.0]	0 to 115 [-18.0 to 46.0]	0 to 115 [-18.0 to 46.0]
	Heating	°F DB [°C DB]		12 to 70 [-11.0 to 21.0]	12 to 70 [-11.0 to 21.0]	-4 to 70 [-20.0 to 21.0]	-4 to 70 [-20.0 to 21.0]	-4 to 70 [-20.0 to 21.0]	-4 to 70 [-20.0 to 21.0]

Notes:
 AHRI Rated Conditions (Rated data is determined at a fixed compressor speed)
 Conditions
¹Cooling (Indoor // Outdoor) °F 80 DB, 67 WB // 95 DB, 75 WB
²Heating at 47°F (Indoor // Outdoor) °F 70 DB, 60 WB // 47 DB, 43 WB
³Heating at 17°F (Indoor // Outdoor) °F 70 DB, 60 WB // 17 DB, 15 WB
⁴Heating at 5°F (Indoor // Outdoor) °F 70 DB, 60 WB // 5 DB, 4 WB

⁵Indoor units receive power from outdoor units through field-supplied interconnected wiring.
⁶Wind baffles required to operate below 23°F DB in cooling mode. PUZ with wind baffle: 0° F - 115° F. Refer to wind baffle documentation for further information.

SEACOAST PROTECTION

- External Outer Panel: Phosphate coating + Acrylic-Enamel coating
- Fan Motor Support: Epoxy resin coating (at edge face)
- Separator Assembly; Valve Bed: Epoxy resin coating (at edge face)
- "Blue Fin" treatment is an anti-corrosion treatment that is applied to the condenser coil to protect it against airborne contaminants.

PVA Specifications



Hyper-heating Heat Pump

Indoor Unit				PVA-A24AA7	PVA-A30AA7	PVA-A36AA7	PVA-A42AA7	
Outdoor Unit				PUZ-HA24NHA1	PUZ-HA30NKA	PUZ-HA36NKA	PUZ-HA42NKA1	
AHRI Certified Reference Number				206223004	206223005	211259275	206223007	
Cooling	Capacity	Rated ¹	BTU/H	24,000	30,000	33,000	42,000	
	Capacity Range	Min-Max	BTU/H	10,000–24,000	14,800–30,000	15,500–36,000	17,000–42,000	
	Power Input	Rated ¹	W	2,100	2,300	2,500	3,960	
	Moisture Removal	Pints/h		3.7	5.9	3.8	5.3	
	Sensible Heat Factor			0.830	0.780	0.870	0.860	
	Sensible Heat Factor - High Latent			—	—	—	—	
Heating	Capacity at 47°F	Rated ²	BTU/H	26,000	32,000	38,000	48,000	
	Capacity Range	Min-Max	BTU/H	10,000–28,000	14,800–34,000	18,600–40,000	23,900–54,000	
	Power Input at 47°F	Rated ²	W	1,980	2,460	2,850	3,850	
	Capacity at 17°F	Rated ³	BTU/H	17,500	21,000	24,600	38,500	
	Capacity at 5°F	Max ⁴	BTU/H	26,000	32,000	38,000	48,000	
	Capacity at -5°F	Max ⁵	BTU/H	—	—	—	—	
Efficiency	SEER2			21.6	20.2	20.0	16.3	
	EER2			14.0	14.1	13.0	10.7	
	HSPF2			10.0	8.8	9.0	9.0	
	COP			3.8	3.8	3.9	3.7	
	Air Flow Rate - Cooling (Quiet-Lo-Med-High-SHigh)	Dry	CFM	613–744–875	613–744–875	788–956–1125	1040–1262–1485	
Air Flow Rate - Heating (Quiet-Lo-Med-High-SHigh)	Dry	CFM	613–744–875	613–744–875	788–956–1125	1040–1262–1485		
Indoor Unit	Sound Pressure Level (Quiet-Lo-Med-High-SHigh)	Cooling	dB(A)	30–34–38	30–34–38	30–34–38	36–40–44	
		Heating	dB(A)	30–34–38	30–34–38	30–34–38	36–40–44	
	External Static Pressure		In. W.G.	0.30–0.5–0.8	0.30–0.5–0.8	0.30–0.5–0.8	0.30–0.5–0.8	
	Condensate Lift Mechanism	Max Distance	In. [mm]	—	—	—	—	
		H	In. [mm]	54-1/4 [1378]	54-1/4 [1378]	59-1/2 [1511]	59-1/2 [1511]	
	Dimensions	W	In. [mm]	21 [534]	21 [534]	25 [635]	25 [635]	
		D	In. [mm]	21-5/8 [548]	21-5/8 [548]	21-5/8 [548]	21-5/8 [548]	
		Weight	lbs [kg]	141 [64]	141 [64]	172 [78]	172 [78]	
	Outdoor Unit	MCA	A		17.0	24.0	24.0	36.0
		MOCP	A		27	40	40	44
Dimensions		H	In. [mm]	37-1/8 [943]	52-11/16 [1338]	52-11/16 [1338]	52-11/16 [1338]	
		W	In. [mm]	37-13/32 [950]	41-5/16 [1050]	41-5/16 [1050]	41-5/16 [1050]	
		D	In. [mm]	14-3/16 [360]	14-3/16 [360]	14-3/16 [360]	14-3/16 [360]	
Weight		lbs [kg]		190 [86]	261 [118]	261 [118]	283 [128]	
Air Flow Rate (Cooling/Heating)		CFM		1940/1940	3880/3880	3880/3880	3319/3319	
Sound Pressure Level		Cooling	dB(A)	52	52	52	49	
		Heating	dB(A)	53	53	53	51	
Piping		Diameter	Gas (O.D.)	In. [mm]	5/8 [15.88]	5/8 [15.88]	5/8 [15.88]	5/8 [15.88]
	Liquid (O.D.)		In. [mm]	3/8 [9.52]	3/8 [9.52]	3/8 [9.52]	3/8 [9.52]	
	Indoor Drain		In. [mm]	3/4 FPT [19.05]	3/4 FPT [19.05]	3/4 FPT [19.05]	3/4 FPT [19.05]	
	Max. Length	ft [m]		165 [50]	245 [75]	245 [75]		
Max. Height	ft [m]		100 [30]	100 [30]	100 [30]			
Electrical	Outdoor-Indoor ⁵	V, ph, Hz		208/230, 1, 60	208/230, 1, 60	208/230, 1, 60	208/230, 1, 60	
	Recommended Breaker Size	A		25	35	35	40	
Refrigerant Type				R410A	R410A	R410A	R410A	
Guaranteed Temperature Operation Range	Cooling ⁶	°F DB [°C DB]		0 to 115 [-18.0 to 46.0]	0 to 115 [-18.0 to 46.0]	0 to 115 [-18.0 to 46.0]	0 to 115 [-18.0 to 46.0]	
	Heating	°F DB [°C DB]		-13 to 70 [-25.0 to 21.0]	-13 to 70 [-25.0 to 21.0]	-13 to 70 [-25.0 to 21.0]	-13 to 70 [-25.0 to 21.0]	

Notes:
 AHRI Rated Conditions
 (Rated data is determined at a fixed compressor speed)
 Conditions

¹Cooling (Indoor // Outdoor) °F 80 DB, 67 WB // 95 DB, 75 WB
²Heating at 47°F (Indoor // Outdoor) °F 70 DB, 60 WB // 47 DB, 43 WB
³Heating at 17°F (Indoor // Outdoor) °F 70 DB, 60 WB // 17 DB, 15 WB
⁴Heating at 5°F (Indoor // Outdoor) °F 70 DB, 60 WB // 5 DB, 4 WB

⁵Indoor units receive power from outdoor units through field-supplied interconnected wiring.
⁶Wind baffles required to operate below 23°F DB in cooling mode. PUZ with wind baffle: 0° F - 115° F.



ELECTRICAL



COIL

BLOWER

FILTER



PEAD

Horizontal-ducted Indoor Unit

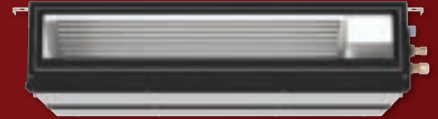

Mid Static Intelli-AIR™ Ducted Solutions

The PEAD Mid Static Intelli-AIR™ Ducted Solutions offer low capacities suitable for Passive Houses up to larger capacities ideal for light commercial uses such as offices, retail, and restaurants. The PEAD is capable of serving large spaces or multiple rooms supplied from a longer duct run.

Capacities: 9,000 to 42,000 BTU/H

Sound: As low as 24 dB(A)

SEER2: Up to 20.70

HSPF2: Up to 11.40

COP: Up to 4.62

ENERGY STAR®: Most systems

Slim Design

The height is only 9-7/8" for all sizes of this model, ranging from 12 to 42 KBTU/H. Its compact size allows for unit installations in low ceilings with minimal clearance space.



Improved Energy Efficiency

Energy-saving efficiency has been improved, reducing electricity consumption and contributing to a further reduction in operating cost.

PEAD Model Selection



Indoor Unit



PEAD-A12/18/24/30/36/42AA7

Outdoor Units

Cooling Only



PUY-A12/18NKA7



PUY-A24/30NHA7



PUY-A36/42NKA7

Heat Pumps



PUZ-A12/18NKA7



PUZ-A24/30NHA7



PUZ-A36/42NKA7

Hyper-heating Heat Pumps



PUZ-HA24NH1



PUZ-HA30/36NKA



PUZ-HA42NK1

Optional Remote Controllers



PAR-40MAAU



PAC-YT53CRAU-J



PAR-CT01MAU-SB



PAC-SDW01RC-1



MHK2



PEAD Specifications



Cooling Only

Indoor Unit			PEAD-A12AA8	PEAD-A18AA8	PEAD-A24AA8	PEAD-A30AA8	PEAD-A36AA8	PEAD-A42AA7		
Outdoor Unit			PUY-A12NKA7	PUY-A18NKA7	PUY-A24NHA7	PUY-A30NHA7	PUY-A36NKA7	PUY-A42NKA7		
AHRI Certified Reference Number			206716974	206716973	209447968	209447972	209447974	209447976		
Cooling	Capacity	Rated ¹	BTU/H	12,000	18,000	24,000	30,000	36,000	42,000	
	Capacity Range	Min-Max	BTU/H	5,000–12,000	8,000–18,000	10,000–24,000	9,000–30,000	16,000–36,000	16,000–42,000	
	Power Input	Rated ¹	W	920	1,660	2,050	3,000	3,000	3,920	
	Moisture Removal	Pints/h		1.8	3.7	6.9	8.6	8.1	9.0	
	Sensible Heat Factor			0.830	0.770	0.680	0.680	0.750	0.760	
Sensible Heat Factor - High Latent				—	—	—	—	—		
Heating	Capacity at 47°F	Rated ²	BTU/H	—	—	—	—	—	—	
	Capacity Range	Min-Max	BTU/H	—	—	—	—	—	—	
	Power Input at 47°F	Rated ²	W	—	—	—	—	—	—	
	Capacity at 17°F	Rated ³	BTU/H	—	—	—	—	—	—	
	Capacity at 5°F	Max ⁴	BTU/H	—	—	—	—	—	—	
	Capacity at -5°F	Max ⁵	BTU/H	—	—	—	—	—	—	
	SEER2			21.3	20.2	16.5	14.5	15.0	14.3	
EER2			13.3	10.7	12.0	9.5	10.5	9.0		
HSPF2			—	—	—	—	—	—		
COP			—	—	—	—	—	—		
ENERGY STAR® Certified			Yes	No	No	No	No	No		
Indoor Unit	Air Flow Rate - Cooling (Quiet-Lo-Med-High-SHigh)	Dry	CFM	353–424–494	424–512–600	512–635–741	618–742–883	847–1024–1201	1042–1254–1483	
		Wet	CFM	318–382–445	382–461–540	461–572–667	556–668–795	762–922–1081	1002–1214–1443	
	Air Flow Rate - Heating (Quiet-Lo-Med-High-SHigh)	Dry	CFM	353–424–494	424–512–600	512–635–741	618–742–883	847–1024–1201	1042–1254–1483	
		Sound Pressure Level (Quiet-Lo-Med-High-SHigh)	Cooling	dB(A)	27–31–34	29–34–37	28–32–36	30–34–39	35–39–42	36–40–44
		Heating	dB(A)	27–31–34	29–34–37	28–32–36	30–34–39	35–39–42	36–40–44	
	External Static Pressure		In. W.G.	0.14–0.2–0.28–0.4–0.6	0.14–0.2–0.28–0.4–0.6	0.14–0.2–0.28–0.4–0.6	0.14–0.2–0.28–0.4–0.6	0.14–0.2–0.28–0.4–0.6	0.14–0.2–0.28–0.4–0.6	
	Dimensions	Condensate Lift Mechanism	Max Distance	In. [mm]	27-9/16 [700]	27-9/16 [700]	27-9/16 [700]	27-9/16 [700]	27-9/16 [700]	
		H	In. [mm]	9-7/8 [250]	9-7/8 [250]	9-7/8 [250]	9-7/8 [250]	9-7/8 [250]	9-7/8 [250]	
			W	In. [mm]	35-7/16 [900]	35-7/16 [900]	43-5/16 [1100]	43-5/16 [1100]	55-1/8 [1400]	55-1/8 [1400]
			D	In. [mm]	28-7/8 [732]	28-7/8 [732]	28-7/8 [732]	28-7/8 [732]	28-7/8 [732]	28-7/8 [732]
Weight		lbs [kg]	58 [26]	60 [27]	67 [30]	67 [30]	84 [38]	91 [41]		
MCA		A	11.0	11.0	19.0	19.0	25.0	25.0		
MOCP		A	28	28	26	26	31	31		
Outdoor Unit	Dimensions	H	In. [mm]	24-13/16 [630]	24-13/16 [630]	37-1/8 [943]	37-1/8 [943]	52-11/16 [1338]	52-11/16 [1338]	
		W	In. [mm]	31-13/16 (+2-7/16) [809 (+62)]	31-13/16 (2+7/16) [809 (+62)]	37-13/32 [950]	37-13/32 [950]	41-5/16 [1050]	41-5/16 [1050]	
		D	In. [mm]	11-13/16 [300]	11-13/16 [300]	13 (+1-3/16) [330 (+30)]	13 (+1-3/16) [330 (+30)]	13 (+1-3/16) [330 (+30)]	13 (+1-3/16) [330 (+30)]	
	Weight		lbs [kg]	92 [41]	99 [44]	151 [68]	151 [68]	211 [96]	211 [96]	
	Air Flow Rate (Cooling/Heating)		CFM	1590/—	1590/—	1940/—	1940/—	3880/—	3880/—	
Sound Pressure Level	Cooling	dB(A)	44	44	47	47	52	52		
	Heating	dB(A)	—	—	—	—	—	—		
Piping	Diameter	Gas (O.D.)	In. [mm]	1/2 [12.7]	1/2 [12.7]	5/8 [15.88]	5/8 [15.88]	5/8 [15.88]	5/8 [15.88]	
		Liquid (O.D)	In. [mm]	1/4 [6.35]	1/4 [6.35]	3/8 [9.52]	3/8 [9.52]	3/8 [9.52]	3/8 [9.52]	
		Indoor Drain	In. [mm]	1-1/4 [32]	1-1/4 [32]	1-1/4 [32]	1-1/4 [32]	1-1/4 [32]	1-1/4 [32]	
	Max. Length		ft [m]	165 [50]	165 [50]	225 [68]	225 [68]	225 [68]	225 [68]	
	Max. Height		ft [m]	100 [30]	100 [30]	100 [30]	100 [30]	100 [30]	100 [30]	
Electrical	Outdoor-Indoor ⁵	V, ph, Hz	208/230, 1, 60	208/230, 1, 60	208/230, 1, 60	208/230, 1, 60	208/230, 1, 60	208/230, 1, 60		
	Recommended Breaker Size	A	15	15	25	25	30	30		
Refrigerant Type			R410A	R410A	R410A	R410A	R410A	R410A		
Guaranteed Temperature Operation Range	Cooling ⁶	°F DB [°C DB]	-40 to 115 [-40.0 to 46.0]	-40 to 115 [-40.0 to 46.0]	-40 to 115 [-40.0 to 46.0]	-40 to 115 [-40.0 to 46.0]	-40 to 115 [-40.0 to 46.0]	-40 to 115 [-40.0 to 46.0]		
	Heating	°F DB [°C DB]	—	—	—	—	—	—		

Notes:
 AHRI Rated Conditions ¹Cooling (Indoor // Outdoor) ⁴F 80 DB, 67 WB // 95 DB, 75 WB
 (Rated data is determined at a fixed compressor speed)
⁵Indoor units receive power from outdoor units through field-supplied interconnected wiring.
⁶Wind baffles required to operate below 23°F DB in cooling mode. PUY with wind baffle: -40°F - 115°F. Refer to wind baffle documentation for further information.
 SEACOAST PROTECTION
 • External Outer Panel: Phosphate coating + Acrylic-Enamel coating
 • Fan Motor Support: Epoxy resin coating (at edge face)
 • Separator Assembly; Valve Bed: Epoxy resin coating (at edge face)
 • "Blue Fin" treatment is an anti-corrosion treatment that is applied to the condenser coil to protect it against airborne contaminants.

PEAD Specifications



Heat Pump

Indoor Unit			PEAD-A12AA8	PEAD-A18AA8	PEAD-A24AA8	PEAD-A30AA8	PEAD-A36AA8	PEAD-A42AA7		
Outdoor Unit			PUZ-A12NKA7	PUZ-A18NKA7	PUZ-A24NHA7	PUZ-A30NHA7	PUZ-A36NKA7	PUZ-A42NKA7		
AHRI Certified Reference Number			211546903	211546902	209447978	209447982	209447984	209447986		
Cooling	Capacity	Rated ¹	BTU/H	12,000	18,000	24,000	30,000	36,000	42,000	
	Capacity Range	Min-Max	BTU/H	5,000–12,000	8,000–18,000	10,000–24,000	9,000–30,000	16,000–36,000	16,000–42,000	
	Power Input	Rated ¹	W	920	1,660	2,050	3,000	3,000	3,920	
	Moisture Removal	Pints/h		1.8	3.7	6.9	8.6	8.1	9.0	
	Sensible Heat Factor			0.830	0.770	0.680	0.680	0.750	0.760	
Sensible Heat Factor - High Latent				—	—	—	—	—		
Heating	Capacity at 47°F	Rated ²	BTU/H	14,000	19,000	26,000	32,000	38,000	45,000	
	Capacity Range	Min-Max	BTU/H	5,800–18,000	7,800–22,000	9,000–28,000	8,800–34,000	18,200–40,000	18,100–48,000	
	Power Input at 47°F	Rated ²	W	1,030	1,400	1,750	2,490	2,410	3,290	
	Capacity at 17°F	Rated ³	BTU/H	8,700	11,000	14,800	18,500	20,400	30,600	
	Capacity at 5°F	Max ⁴	BTU/H	—	—	14,300	17,700	19,800	29,400	
	Capacity at -5°F	Max ⁵	BTU/H	—	—	—	—	—	—	
Efficiency	SEER2			21.3	20.2	16.5	14.5	15.0	14.3	
	EER2			13.3	10.7	12.0	9.5	10.5	9.0	
	HSPF2			10.2	9.2	9.0	9.0	8.5	8.5	
	COP			3.9	3.9	4.3	3.7	4.6	4.0	
	ENERGY STAR® Certified			Yes	No	No	No	No	No	
Indoor Unit	Air Flow Rate - Cooling (Quiet-Lo-Med-High-SHigh)	Dry	CFM	353–424–494	424–512–600	512–635–741	618–742–883	847–1024–1201	1042–1254–1483	
		Wet	CFM	318–382–445	382–461–540	461–572–667	556–668–795	762–922–1081	1002–1214–1443	
	Air Flow Rate - Heating (Quiet-Lo-Med-High-SHigh)	Dry	CFM	353–424–494	424–512–600	512–635–741	618–742–883	847–1024–1201	1042–1254–1483	
		Sound Pressure Level (Quiet-Lo-Med-High-SHigh)	Cooling	dB(A)	27–31–34	29–34–37	28–32–36	30–34–39	35–39–42	36–40–44
		Heating	dB(A)	27–31–34	29–34–37	28–32–36	30–34–39	35–39–42	36–40–44	
	External Static Pressure		In. W.G.	0.14–0.2–0.28–0.4–0.6	0.14–0.2–0.28–0.4–0.6	0.14–0.2–0.28–0.4–0.6	0.14–0.2–0.28–0.4–0.6	0.14–0.2–0.28–0.4–0.6	0.14–0.2–0.28–0.4–0.6	
	Dimensions	Condensate Lift Mechanism	Max Distance	In. [mm]	27-9/16 [700]	27-9/16 [700]	27-9/16 [700]	27-9/16 [700]	27-9/16 [700]	27-9/16 [700]
		H	In. [mm]	9-7/8 [250]	9-7/8 [250]	9-7/8 [250]	9-7/8 [250]	9-7/8 [250]	9-7/8 [250]	9-7/8 [250]
			W	In. [mm]	35-7/16 [900]	35-7/16 [900]	43-5/16 [1100]	43-5/16 [1100]	55-1/8 [1400]	55-1/8 [1400]
			D	In. [mm]	28-7/8 [732]	28-7/8 [732]	28-7/8 [732]	28-7/8 [732]	28-7/8 [732]	28-7/8 [732]
Weight		lbs [kg]	58 [26]	60 [27]	67 [30]	67 [30]	84 [38]	91 [41]		
Outdoor Unit	MCA	A		11.0	11.0	19.0	19.0	25.0	25.0	
	MOCP	A		28	28	26	26	31	31	
	Dimensions	H	In. [mm]	24-13/16 [630]	24-13/16 [630]	37-1/8 [943]	37-1/8 [943]	52-11/16 [1338]	52-11/16 [1338]	
		W	In. [mm]	31-13/16 (2+7/16) [809 (+62)]	31-13/16 (2+7/16) [809 (+62)]	37-13/32 [950]	37-13/32 [950]	41-5/16 [1050]	41-5/16 [1050]	
		D	In. [mm]	11-13/16 [300]	11-13/16 [300]	13 (+1-3/16) [330 (+30)]	13 (+1-3/16) [330 (+30)]	13 (+1-3/16) [330 (+30)]	13 (+1-3/16) [330 (+30)]	
	Weight		lbs [kg]	93 [42]	100 [45]	153 [69]	153 [69]	214 [97]	214 [97]	
	Air Flow Rate (Cooling/Heating)	CFM		1590/1590	1590/1590	1940/1940	1940/1940	3880/3880	3880/3880	
Sound Pressure Level	Cooling	dB(A)	44	44	47	47	52	52		
	Heating	dB(A)	46	46	48	48	53	53		
Piping	Diameter	Gas (O.D.)	In. [mm]	1/2 [12.7]	1/2 [12.7]	5/8 [15.88]	5/8 [15.88]	5/8 [15.88]	5/8 [15.88]	
		Liquid (O.D.)	In. [mm]	1/4 [6.35]	1/4 [6.35]	3/8 [9.52]	3/8 [9.52]	3/8 [9.52]	3/8 [9.52]	
		Indoor Drain	In. [mm]	1-1/4 [32]	1-1/4 [32]	1-1/4 [32]	1-1/4 [32]	1-1/4 [32]	1-1/4 [32]	
	Max. Length		ft [m]	100 [30]	100 [30]	165 [50]	165 [50]	165 [50]	165 [50]	
Max. Height		ft [m]	100 [30]	100 [30]	100 [30]	100 [30]	100 [30]	100 [30]		
Electrical	Outdoor-Indoor ⁵	V, ph, Hz		208/230, 1, 60	208/230, 1, 60	208/230, 1, 60	208/230, 1, 60	208/230, 1, 60	208/230, 1, 60	
	Recommended Breaker Size	A		15	15	25	25	30	30	
Refrigerant Type				R410A	R410A	R410A	R410A	R410A	R410A	
Guaranteed Temperature Operation Range	Cooling ⁶	°F DB [°C DB]		0 to 115 [-18.0 to 46.0]	0 to 115 [-18.0 to 46.0]	0 to 115 [-18.0 to 46.0]	0 to 115 [-18.0 to 46.0]	0 to 115 [-18.0 to 46.0]	0 to 115 [-18.0 to 46.0]	
	Heating	°F DB [°C DB]		12 to 70 [-11.0 to 21.0]	12 to 70 [-11.0 to 21.0]	-4 to 70 [-20.0 to 21.0]	-4 to 70 [-20.0 to 21.0]	-4 to 70 [-20.0 to 21.0]	-4 to 70 [-20.0 to 21.0]	

Notes:
 AHRI Rated Conditions ¹Cooling (Indoor // Outdoor) °F 80 DB, 67 WB // 95 DB, 75 WB
 (Rated data is determined at a fixed compressor speed) ²Heating at 47°F (Indoor // Outdoor) °F 70 DB, 60 WB // 47 DB, 43 WB
³Heating at 17°F (Indoor // Outdoor) °F 70 DB, 60 WB // 17 DB, 15 WB
 Conditions ⁴Heating at 5°F (Indoor // Outdoor) °F 70 DB, 60 WB // 5 DB, 4 WB
⁵Indoor units receive power from outdoor units through field-supplied interconnected wiring.
⁶Wind baffles required to operate below 23°F DB in cooling mode. PUZ with wind baffle: 0° F - 115° F. Refer to wind baffle documentation for further information.

- SEACAST PROTECTION
- External Outer Panel: Phosphate coating + Acrylic-Enamel coating
 - Fan Motor Support: Epoxy resin coating (at edge face)
 - Separator Assembly; Valve Bed: Epoxy resin coating (at edge face)
 - *Blue Fin* treatment is an anti-corrosion treatment that is applied to the condenser coil to protect it against airborne contaminants.

PEAD Specifications



Hyper-heating Heat Pump

Indoor Unit			PEAD-A24AA8	PEAD-A30AA8	PEAD-A36AA8	PEAD-A42AA7		
Outdoor Unit			PUZ-HA24NHA1	PUZ-HA30NKA	PUZ-HA36NKA	PUZ-HA42NKA1		
AHRI Certified Reference Number			211273264	211273265	211259275	211273266		
Cooling	Capacity	Rated ¹	BTU/H	24,000	30,000	36,000	42,000	
	Capacity Range	Min-Max	BTU/H	10,000–24,000	14,600–30,000	15,600–36,000	17,100–42,000	
	Power Input	Rated ¹	W	2,080	2,350	2,850	3,900	
	Moisture Removal	Pints/h		6.9	6.5	5.2	4.1	
	Sensible Heat Factor			0.680	0.760	0.840	0.890	
Sensible Heat Factor - High Latent			—	—	—	—		
Heating	Capacity at 47°F	Rated ²	BTU/H	25,000	32,000	38,000	48,000	
	Capacity Range	Min-Max	BTU/H	10,000–28,000	14,800–34,000	17,400–40,000	21,200	
	Power Input at 47°F	Rated ²	W	1,920	2,740	2,940	3,990	
	Capacity at 17°F	Rated ³	BTU/H	18,000	21,000	25,400	39,000	
		Max	BTU/H	25,000	32,000	38,000	48,000	
	Capacity at 5°F	Max ⁴	BTU/H	25,000	32,000	38,000	48,000	
	Max ⁵	BTU/H	—	—	—	—		
Efficiency	SEER2			21.6	20.2	20.0	16.3	
	EER2			14.0	14.1	13.0	10.7	
	HSPF2			10.0	8.8	9.0	9.0	
	COP			3.8	3.4	3.7	3.5	
	ENERGY STAR® Certified			No	Yes	Yes	No	
Indoor Unit	Air Flow Rate - Cooling (Quiet-Lo-Med-High-SHigh)	Dry	CFM	512–635–741	618–742–883	847–1024–1201	1042–1254–1483	
		Wet	CFM	461–572–667	556–668–795	762–922–1081	1002–1214–1443	
	Air Flow Rate - Heating (Quiet-Lo-Med-High-SHigh)	Dry	CFM	512–635–741	618–742–883	847–1024–1201	1042–1254–1483	
		Sound Pressure Level (Quiet-Lo-Med-High-SHigh)	Cooling	dB(A)	28–32–36	30–34–39	35–39–42	36–40–44
		Heating	dB(A)	28–32–36	30–34–39	35–39–42	36–40–44	
	External Static Pressure		In. W.G.	0.14–0.2–0.28–0.4–0.6	0.14–0.2–0.28–0.4–0.6	0.14–0.2–0.28–0.4–0.6	0.14–0.2–0.28–0.4–0.6	
	Dimensions	Condensate Lift Mechanism	Max Distance	In. [mm]	27-9/16 [700]	27-9/16 [700]	27-9/16 [700]	27-9/16 [700]
		H		In. [mm]	9-7/8 [250]	9-7/8 [250]	9-7/8 [250]	9-7/8 [250]
			W	In. [mm]	43-5/16 [1100]	43-5/16 [1100]	55-1/8 [1400]	55-1/8 [1400]
			D	In. [mm]	28-7/8 [732]	28-7/8 [732]	28-7/8 [732]	28-7/8 [732]
Weight		lbs [kg]	67 [30]	67 [30]	84 [38]	91 [41]		
MCA	A		17.0	24.0	24.0	36.0		
MOC	A		27	40	40	44		
Outdoor Unit	Dimensions	H	In. [mm]	37-1/8 [943]	52-11/16 [1338]	52-11/16 [1338]	52-11/16 [1338]	
		W	In. [mm]	37-13/32 [950]	41-5/16 [1050]	41-5/16 [1050]	41-5/16 [1050]	
		D	In. [mm]	14-3/16 [360]	14-3/16 [360]	14-3/16 [360]	14-3/16 [360]	
	Weight		lbs [kg]	190 [86]	261 [118]	261 [118]	283 [128]	
	Air Flow Rate (Cooling/Heating)		CFM	1940/1940	3880/3880	3880/3880	3319/3319	
	Sound Pressure Level	Cooling	dB(A)	52	52	52	49	
Heating		dB(A)	53	53	53	51		
Piping	Diameter	Gas (O.D.)	In. [mm]	5/8 [15.88]	5/8 [15.88]	5/8 [15.88]	5/8 [15.88]	
		Liquid (O.D.)	In. [mm]	3/8 [9.52]	3/8 [9.52]	3/8 [9.52]	3/8 [9.52]	
		Indoor Drain	In. [mm]	1-1/4 [32]	1-1/4 [32]	1-1/4 [32]	1-1/4 [32]	
	Max. Length		ft [m]	165 [50]	245 [75]	245 [75]	245 [75]	
Max. Height		ft [m]	100 [30]	100 [30]	100 [30]	100 [30]		
Electrical	Outdoor-Indoor ⁵	V, ph, Hz	208/230, 1, 60	208/230, 1, 60	208/230, 1, 60	208/230, 1, 60		
	Recommended Breaker Size	A	25	35	35	40		
Refrigerant Type			R410A	R410A	R410A	R410A		
Guaranteed Temperature Operation Range	Cooling ⁶	°F DB [°C DB]	0 to 115 [-18.0 to 46.0]	0 to 115 [-18.0 to 46.0]	0 to 115 [-18.0 to 46.0]	0 to 115 [-18.0 to 46.0]		
	Heating	°F DB [°C DB]	-13 to 70 [-25.0 to 21.0]	-13 to 70 [-25.0 to 21.0]	-13 to 70 [-25.0 to 21.0]	-13 to 70 [-25.0 to 21.0]		

Notes:
 AHRI Rated Conditions ¹Cooling (Indoor // Outdoor) °F 80 DB, 67 WB // 95 DB, 75 WB
 (Rated data is determined at a fixed compressor speed) ²Heating at 47°F (Indoor // Outdoor) °F 70 DB, 60 WB // 47 DB, 43 WB
 Conditions ³Heating at 17°F (Indoor // Outdoor) °F 70 DB, 60 WB // 17 DB, 15 WB
⁴Heating at 5°F (Indoor // Outdoor) °F 70 DB, 60 WB // 5 DB, 4 WB
⁵Indoor units receive power from outdoor units through field-supplied interconnected wiring.
⁶Wind baffles required to operate below 23°F DB in cooling mode. PUZ with wind baffle: 0° F - 115° F.



intelli-HEAT™

Cased Coil Indoor Unit



intelli-HEAT™ Dual Fuel System

intelli-HEAT Dual Fuel System will seamlessly replace a traditional unitary air conditioner, add air conditioning to an existing furnace, or be the ideal solution for a new installation. The system intelligently switches between our all-electric heat pump and an existing gas furnace to ensure lower utility bills and reduce greenhouse gas emissions.

Capacities: 18,000 to 36,000 BTU/H

Sound: As low as 24 dB(A)

SEER2: Up to 16.50

HSPF2: Up to 9.00

COP: Up to 3.55

ENERGY STAR®: Some systems



Comfort While Reducing your Carbon Footprint

The intelli-HEAT™ Dual Fuel System can seamlessly replace your unitary air conditioner. intelli-HEAT will intelligently switch over between our all-electric heat pump and an existing gas furnace* based on capacity or economic balance points, making this a true dual fuel system. intelli-HEAT can be connected as a single-zone cooling only, heat pump, or hyper-heating heat pump system as well as part of a multi-zone system.



Single- and Multi-zone Options

intelli-HEAT connects to P-Series, MXZ, and Smart Multi™ outdoor units providing cooling only, heat pump, and hyper-heating options.

intelli-HEAT™ Model Selection



Indoor Unit



PAA-A18/24/30/36(A/B/C)A1

Outdoor Units

Cooling Only



PUY-A24/30NHA7



PUY-A36/42NKA7

Heat Pumps



PUZ-A24/30NHA7



PUZ-A36/42NKA7

Hyper-heating Heat Pumps



PUZ-HA24NH1



PUZ-HA30/36NKA



PUZ-HA42NK1

Optional Remote Controllers



PAR-40MAAU



PAC-YT53CRAU-J



PAR-CT01MAU-SB



PAC-SDW01RC-1



MHK2



intelli-HEAT™ Specifications

Heat Pump

Indoor Unit			PAA-A18AA1	PAA-A18BA1	PAA-A24AA1	PAA-A24BA1	PAA-A30AA1	PAA-A30BA1	PAA-A36BA1	PAA-A36CA1	PAA-A42BA1	PAA-A42CA1		
Outdoor Unit			PUZ-A24NHA7	PUZ-A24NHA7	PUZ-A24NHA7	PUZ-A24NHA7	PUZ-A30NHA7	PUZ-A30NHA7	PUZ-A36NKA7	PUZ-A36NKA7	PUZ-A42NKA7	PUZ-A42NKA7		
AHRI Certified Reference Number			209447978	209447978	209447978	209447978	209447982	209447982	209447984	209447984	209447986	209447986		
Cooling	Capacity	Rated ¹	BTU/H	18,000	18,000	24,000	24,000	30,000	30,000	36,000	36,000	42,000	42,000	
	Capacity Range	Min-Max	BTU/H	9,600–18,000	9,600–18,000	10,600–24,000	10,600–24,000	9,600–30,000	9,600–30,000	17,800–36,000	17,800–36,000	19,800–42,000	19,800–42,000	
	Power Input	Rated ¹	W	1,440	1,440	1,920	1,920	3,000	3,000	3,600	3,600	4,420	4,420	
	Moisture Removal	Pints/h		3.7	3.7	5.0	5.0	6.8	6.8	7.5	7.5	8.0	8.0	
	Sensible Heat Factor			0.770	0.770	0.770	0.770	0.750	0.750	0.770	0.770	0.790	0.790	
	Sensible Heat Factor - High Latent			—	—	—	—	—	—	—	—	—	—	
Heating	Capacity at 47°F	Rated ²	BTU/H	19,000	19,000	26,000	26,000	32,000	32,000	38,000	38,000	46,000	46,000	
	Capacity Range	Min-Max	BTU/H	11,900–22,400	11,900–22,400	12,400–31,000	12,400–31,000	13,100–35,200	13,100–35,200	19,400–43,000	19,400–43,000	20,600–49,600	20,600–49,600	
	Power Input at 47°F	Rated ²	W	1,740	1,740	2,140	2,140	2,640	2,640	3,590	3,590	4,490	4,490	
	Capacity at 17°F	Rated ³	BTU/H	13,800	13,800	15,600	15,600	21,000	21,000	29,400	29,400	32,800	32,800	
		Max	BTU/H	13,800	13,800	15,400	15,400	20,800	20,800	29,000	29,000	32,400	32,400	
	Capacity at 5°F	Max ⁴	BTU/H	12,400	12,400	13,900	13,900	18,700	18,700	26,300	26,300	29,300	29,300	
	Capacity at -5°F	Max ⁵	BTU/H	—	—	—	—	—	—	—	—	—	—	
Efficiency	SEER2			16.5	16.5	16.5	16.5	14.5	14.5	15.0	15.0	14.3	14.3	
	EER2			—	—	—	—	—	—	—	—	—	—	
	HSF2			9.0	9.0	9.0	9.0	9.0	9.0	8.5	8.5	8.5	8.5	
	COP			3.2	3.2	3.55	3.55	3.55	3.55	3.1	3.1	3.0	3.0	
Indoor Unit	Rated Airflow	Dry	CFM	525	525	700	700	875	875	1050	1050	1225	1225	
	Maximum Airflow	Dry	CFM	812	812	830	830	1024	1024	1201	1201	1660	1660	
	Minimum Airflow	Dry	CFM	424	424	551	551	700	700	800	800	936	936	
	Internal Static Pressure [at Rated CFM]	In. W.G.		0.09	0.07	0.18	0.12	0.24	0.18	0.21	0.19	0.27	0.26	
	Control Box Weight	lbs [kg]		11.00 [4.99]	11.00 [4.99]	11.00 [4.99]	11.00 [4.99]	11.00 [4.99]	11.00 [4.99]	11.00 [4.99]	11.00 [4.99]	11.00 [4.99]	11.00 [4.99]	
	Dimensions	H	In. [mm]		27.4 [696.0]	27.4 [696.0]	27.4 [696.0]	27.4 [696.0]	27.4 [696.0]	27.4 [696.0]	31.9 [810.3]	31.9 [810.3]	31.9 [810.3]	31.9 [810.3]
		W	In. [mm]		14.5 [368.3]	17.5 [445.0]	14.5 [368.3]	17.5 [445.0]	14.5 [368.3]	17.5 [445.0]	17.5 [445.0]	21.0 [533.4]	17.5 [445.0]	21.0 [533.4]
		D	In. [mm]		21.7 [551.2]	21.7 [551.2]	21.7 [551.2]	21.7 [551.2]	21.7 [551.2]	21.7 [551.2]	21.7 [551.2]	21.7 [551.2]	21.7 [551.2]	21.7 [551.2]
	Unit Weight [Cased Coil Only]	lbs [kg]		47 [21.0]	54 [24.0]	48 [22.0]	58 [26.0]	48 [22.0]	58 [26.0]	67 [31.0]	82 [37.0]	67 [31.0]	82 [37.0]	
	MCA	A		19.0	19.0	19.0	19.0	19.0	19.0	25.0	25.0	25.0	25.0	
MOCF	A		26	26	26	26	26	26	31	31	31	31		
Outdoor Unit	Dimensions	H	In. [mm]	37-1/8 [943]	37-1/8 [943]	37-1/8 [943]	37-1/8 [943]	37-1/8 [943]	37-1/8 [943]	52-11/16 [1338]	52-11/16 [1338]	52-11/16 [1338]	52-11/16 [1338]	
		W	In. [mm]	37-13/32 [950]	37-13/32 [950]	37-13/32 [950]	37-13/32 [950]	37-13/32 [950]	37-13/32 [950]	41-5/16 [1050]	41-5/16 [1050]	41-5/16 [1050]	41-5/16 [1050]	
		D	In. [mm]	13 (+1-3/16) [330 (+30)]	13 (+1-3/16) [330 (+30)]	13 (+1-3/16) [330 (+30)]	13 (+1-3/16) [330 (+30)]	13 (+1-3/16) [330 (+30)]	13 (+1-3/16) [330 (+30)]	13 (+1-3/16) [330 (+30)]	13 (+1-3/16) [330 (+30)]	13 (+1-3/16) [330 (+30)]	13 (+1-3/16) [330 (+30)]	
	Weight	lbs [kg]		153 [69]	153 [69]	153 [69]	153 [69]	153 [69]	153 [69]	214 [97]	214 [97]	214 [97]	214 [97]	
	Air Flow Rate (Cooling/Heating)	CFM		1940/1940	1940/1940	1940/1940	1940/1940	1940/1940	1940/1940	3880/3880	3880/3880	3880/3880	3880/3880	
	Sound Pressure Level	Cooling	dB(A)		47	47	47	47	47	47	52	52	52	52
		Heating	dB(A)		48	48	48	48	48	48	53	53	53	53
Piping	Diameter	Gas (O.D.)	In. [mm]	5/8 [15.88]	5/8 [15.88]	5/8 [15.88]	5/8 [15.88]	5/8 [15.88]	5/8 [15.88]	5/8 [15.88]	5/8 [15.88]	5/8 [15.88]	5/8 [15.88]	
		Liquid (O.D.)	In. [mm]	3/8 [9.52]	3/8 [9.52]	3/8 [9.52]	3/8 [9.52]	3/8 [9.52]	3/8 [9.52]	3/8 [9.52]	3/8 [9.52]	3/8 [9.52]	3/8 [9.52]	
		Indoor Drain	In. [mm]	3/4 [19.05]	3/4 [19.05]	3/4 [19.05]	3/4 [19.05]	3/4 [19.05]	3/4 [19.05]	3/4 [19.05]	3/4 [19.05]	3/4 [19.05]	3/4 [19.05]	
	Max. Length	ft [m]		165 [50]	165 [50]	165 [50]	165 [50]	165 [50]	165 [50]	165 [50]	165 [50]	165 [50]	165 [50]	
	Max. Height	ft [m]		100 [30]	100 [30]	100 [30]	100 [30]	100 [30]	100 [30]	100 [30]	100 [30]	100 [30]	100 [30]	
Electrical	Outdoor-Indoor ⁵	V, ph, Hz		208/230, 1, 60	208/230, 1, 60	208/230, 1, 60	208/230, 1, 60	208/230, 1, 60	208/230, 1, 60	208/230, 1, 60	208/230, 1, 60	208/230, 1, 60	208/230, 1, 60	
	Recommended Breaker Size	A		25	25	25	25	25	25	30	30	30	30	
Refrigerant Type			R410A	R410A	R410A	R410A	R410A	R410A	R410A	R410A	R410A	R410A		
Guaranteed Temperature Operation Range	Cooling ⁶	°F DB [°C DB]		0 to 115 [-18.0 to 46.0]	0 to 115 [-18.0 to 46.0]	0 to 115 [-18.0 to 46.0]	0 to 115 [-18.0 to 46.0]	0 to 115 [-18.0 to 46.0]	0 to 115 [-18.0 to 46.0]	0 to 115 [-18.0 to 46.0]	0 to 115 [-18.0 to 46.0]	0 to 115 [-18.0 to 46.0]		
	Heating	°F DB [°C DB]		-4 to 70 [-20.0 to 21.0]	-4 to 70 [-20.0 to 21.0]	-4 to 70 [-20.0 to 21.0]	-4 to 70 [-20.0 to 21.0]	-4 to 70 [-20.0 to 21.0]	-4 to 70 [-20.0 to 21.0]	-4 to 70 [-20.0 to 21.0]	-4 to 70 [-20.0 to 21.0]	-4 to 70 [-20.0 to 21.0]		

Notes:
 AHRI Rated Conditions
 (Rated data is determined at a fixed compressor speed)
 Conditions
¹Cooling (Indoor // Outdoor) °F 80 DB, 67 WB // 95 DB, 75 WB
²Heating at 47°F (Indoor // Outdoor) °F 70 DB, 60 WB // 47 DB, 43 WB
³Heating at 17°F (Indoor // Outdoor) °F 70 DB, 60 WB // 17 DB, 15 WB
⁴Heating at 5°F (Indoor // Outdoor) °F 70 DB, 60 WB // 5 DB, 4 WB
⁵Indoor units receive power from outdoor units through field-supplied interconnected wiring.
⁶Wind baffles required to operate below 23°F DB in cooling mode. PUZ with wind baffle: 0° F - 115° F. Refer to wind baffle documentation for further information.
 SEACOAST PROTECTION
 • External Outer Panel: Phosphate coating + Acrylic-Enamel coating
 • Fan Motor Support: Epoxy resin coating (at edge face)
 • Separator Assembly, Valve Bed: Epoxy resin coating (at edge face)
 • "Blue Fin" treatment is an anti-corrosion treatment that is applied to the condenser coil to protect it against airborne contaminants.

intelli-HEAT™ Specifications

Hyper-heating Heat Pump

Indoor Unit				PAA-A24AA1	PAA-A24BA1	PAA-A30AA1	PAA-A30BA1	PAA-A36BA1	PAA-A36CA1	
Outdoor Unit				PUZ-HA24NHA1	PUZ-HA24NHA1	PUZ-HA30NKA	PUZ-HA30NKA	PUZ-HA36NKA	PUZ-HA36NKA	
AHRI Certified Reference Number				211273264	211273264	211273265	211273265	211259275	211259275	
Cooling	Capacity	Rated ¹	BTU/H	24,000	24,000	30,000	30,000	36,000	36,000	
	Capacity Range	Min-Max	BTU/H	11,800–24,000	11,800–24,000	17,000–30,000	17,000–30,000	16,600–36,000	16,600–36,000	
	Power Input	Rated ¹	W	2,180	2,180	2,400	2,400	3,270	3,270	
	Moisture Removal	Pints/h			5.0	5.0	6.2	6.2	7.5	7.5
	Sensible Heat Factor				0.770	0.770	0.770	0.770	0.770	0.770
	Sensible Heat Factor - High Latent				—	—	—	—	—	—
Heating	Capacity at 47°F	Rated ²	BTU/H	26,000	26,000	32,000	32,000	38,000	38,000	
	Capacity Range	Min-Max	BTU/H	11,100–26,000	11,100–26,000	16,100–35,400	16,100–35,400	20,500–42,000	20,500–42,000	
	Power Input at 47°F	Rated ²	W	2,140	2,140	2,640	2,640	3,530	3,530	
	Capacity at 17°F	Rated ³	BTU/H	16,600	16,600	23,200	23,200	28,400	28,400	
	Capacity at 5°F	Max ⁴	BTU/H	26,000	26,000	32,000	32,000	38,000	38,000	
	Capacity at -5°F	Max ⁵	BTU/H	—	—	—	—	—	—	
	SEER2				21.6	21.6	20.2	20.2	20.0	20.0
EER2				—	—	—	—	—	—	
HSF2				10.0	10.0	8.8	8.8	9.0	9.0	
COP				3.55	3.55	3.55	3.55	3.15	3.15	
Indoor Unit	Rated Airflow	Dry	CFM	700	700	875	875	1050	1050	
	Maximum Airflow	Dry	CFM	830	830	1024	1024	1201	1201	
	Minimum Airflow	Dry	CFM	551	551	700	700	800	800	
	Internal Static Pressure [at Rated CFM]	In. W.G.			0.18	0.12	0.24	0.18	0.21	0.19
	Control Box Weight	lbs [kg]			11.00 [4.99]	11.00 [4.99]	11.00 [4.99]	11.00 [4.99]	11.00 [4.99]	11.00 [4.99]
	Dimensions	H	In. [mm]		27.4 [696.0]	27.4 [696.0]	27.4 [696.0]	27.4 [696.0]	31.9 [810.3]	31.9 [810.3]
		W	In. [mm]		14.5 [368.3]	17.5 [445.0]	14.5 [368.3]	17.5 [445.0]	17.5 [445.0]	21.0 [533.4]
		D	In. [mm]		21.7 [551.2]	21.7 [551.2]	21.7 [551.2]	21.7 [551.2]	21.7 [551.2]	21.7 [551.2]
		Unit Weight [Cased Coil Only]	lbs [kg]			48 [22.0]	58 [26.0]	48 [22.0]	58 [26.0]	67 [31.0]
	MCA	A			17.0	17.0	24.0	24.0	24.0	24.0
MOC	A			27	27	40	40	40	40	
Outdoor Unit	Dimensions	H	In. [mm]	37-1/8 [943]	37-1/8 [943]	52-11/16 [1338]	52-11/16 [1338]	52-11/16 [1338]	52-11/16 [1338]	
		W	In. [mm]	37-13/32 [950]	37-13/32 [950]	41-5/16 [1050]	41-5/16 [1050]	41-5/16 [1050]	41-5/16 [1050]	
		D	In. [mm]	14-3/16 [360]	14-3/16 [360]	14-3/16 [360]	14-3/16 [360]	14-3/16 [360]	14-3/16 [360]	
		Weight	lbs [kg]			190 [86]	190 [86]	261 [118]	261 [118]	261 [118]
	Air Flow Rate (Cooling/Heating)	CFM			1940/1940	1940/1940	3880/3880	3880/3880	3880/3880	3880/3880
Sound Pressure Level	Cooling	dB(A)		52	52	52	52	52	52	
	Heating	dB(A)		53	53	53	53	53	53	
Piping	Diameter	Gas (O.D.)	In. [mm]	5/8 [15.88]	5/8 [15.88]	5/8 [15.88]	5/8 [15.88]	5/8 [15.88]	5/8 [15.88]	
		Liquid (O.D.)	In. [mm]	3/8 [9.52]	3/8 [9.52]	3/8 [9.52]	3/8 [9.52]	3/8 [9.52]	3/8 [9.52]	
		Indoor Drain	In. [mm]	3/4 [19.05]	3/4 [19.05]	3/4 [19.05]	3/4 [19.05]	3/4 [19.05]	3/4 [19.05]	
	Max. Length	ft [m]			165 [50]	165 [50]	245 [75]	245 [75]	245 [75]	
	Max. Height	ft [m]			100 [30]	100 [30]	100 [30]	100 [30]	100 [30]	
Electrical	Outdoor-Indoor ⁶	V, ph, Hz		208/230, 1, 60	208/230, 1, 60	208/230, 1, 60	208/230, 1, 60	208/230, 1, 60	208/230, 1, 60	
	Recommended Breaker Size	A			25	25	35	35	35	
Refrigerant Type				R410A	R410A	R410A	R410A	R410A	R410A	
Guaranteed Temperature Operation Range	Cooling ⁶	°F DB [°C DB]		0 to 115 [-18.0 to 46.0]	0 to 115 [-18.0 to 46.0]	0 to 115 [-18.0 to 46.0]	0 to 115 [-18.0 to 46.0]	0 to 115 [-18.0 to 46.0]	0 to 115 [-18.0 to 46.0]	
	Heating	°F DB [°C DB]		-13 to 70 [-25.0 to 21.0]	-13 to 70 [-25.0 to 21.0]	-13 to 70 [-25.0 to 21.0]	-13 to 70 [-25.0 to 21.0]	-13 to 70 [-25.0 to 21.0]	-13 to 70 [-25.0 to 21.0]	

Notes:
 AHRI Rated Conditions
 (Rated data is determined at a fixed compressor speed)
 Conditions

¹Cooling (Indoor // Outdoor) °F 80 DB, 67 WB // 95 DB, 75 WB
²Heating at 47°F (Indoor // Outdoor) °F 70 DB, 60 WB // 47 DB, 43 WB
³Heating at 17°F (Indoor // Outdoor) °F 70 DB, 60 WB // 17 DB, 15 WB
⁴Heating at 5°F (Indoor // Outdoor) °F 70 DB, 60 WB // 5 DB, 4 WB

⁵Indoor units receive power from outdoor units through field-supplied interconnected wiring.
⁶Wind baffles required to operate below 23°F DB in cooling mode. PUZ with wind baffle: 0° F - 115° F.

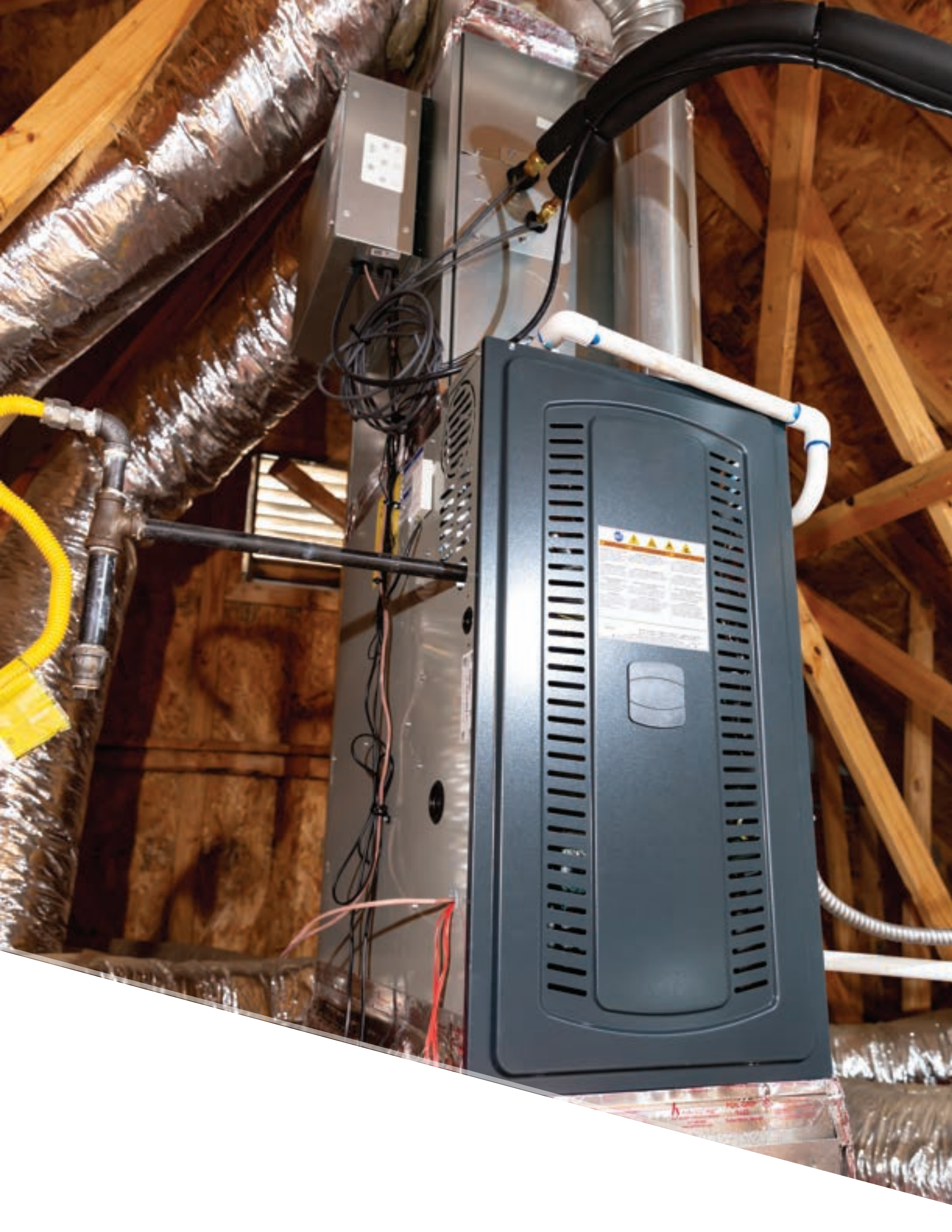

PCA

Ceiling-suspended Indoor Unit

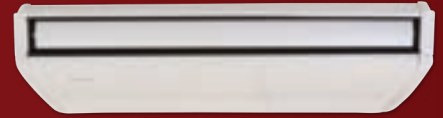

Ceiling-suspended Indoor Unit

The PCA Ceiling-suspended Indoor Unit is ideal for larger retail stores, commercial kitchens, classrooms, and office spaces. The PCA features automatic airspeed adjustment and high/low ceiling modes. An optional i-see Sensor™ scans the room temperature and occupant locations to deliver additional airflow control.

Capacities: 24,000 to 42,000 BTU/H

Sound: As low as 33 dB(A)

SEER2: Up to 21.00

HSPF2: Up to 9.50

COP: Up to 4.62

ENERGY STAR®: Some systems



High/Low-ceiling Modes

High- and Low-ceiling Operation modes match the airflow volume to the room height. This option adjusts the airflow volume and ensures even temperature distribution throughout the room.



Automatic Air-speed Adjustment

The Automatic Air-speed Adjustment setting changes the speed to match the room environment conditions. The airflow is set to high at the start of the heating or cooling operation, quickly conditioning the space. When the room temperature reaches the set point, the airflow decreases automatically for stable, comfortable heating and cooling operation.

PCA Model Selection



Indoor Unit



PCA-A24/30/36/42KA7

Outdoor Units

Cooling Only



PUY-A24/30NHA7



PUY-A36/42NKA7

Heat Pumps



PUZ-A24/30NHA7



PUZ-A36/42NKA7

Hyper-heating Heat Pumps



PUZ-HA24NH1



PUZ-HA30/36NKA



PUZ-HA42NK1

Optional Remote Controllers



PAR-40MAAU



PAC-YT53CRAU-J



PAR-CT01MAU-SB



PAC-SDW01RC-1



MHK2



PCA Specifications



Heat Pump

Indoor Unit				PCA-A24KA7	PCA-A30KA7	PCA-A36KA7	PCA-A42KA7
Outdoor Unit				PUZ-A24NHA7	PUZ-A30NHA7	PUZ-A36NKA7	PUZ-A42NKA7
AHRI Certified Reference Number				209447978	209447982	209447984	209447986
Cooling	Capacity	Rated ¹	BTU/H	24,000	30,000	36,000	42,000
	Capacity Range	Min-Max	BTU/H	10,000–24,000	9,000–30,000	16,000–36,000	16,000–42,000
	Power Input	Rated ¹	W	1,960	3,190	3,270	4,110
	Moisture Removal	Pints/h		5.8	8.3	8.7	11.7
	Sensible Heat Factor			0.730	0.690	0.730	0.690
	Sensible Heat Factor - High Latent			20	20	20	20
Heating	Capacity at 47°F	Rated ²	BTU/H	26,000	32,000	38,000	45,000
	Capacity Range	Min-Max	BTU/H	8,800–28,000	8,600–34,000	17,900–40,000	18,100–48,000
	Power Input at 47°F	Rated ²	W	1,800	2,520	2,410	3,480
	Capacity at 17°F	Rated ³	BTU/H	15,400	18,800	21,000	31,800
	Capacity at 5°F	Max ⁴	BTU/H	17,900	21,600	24,400	35,000
	Capacity at -5°F	Max ⁵	BTU/H	—	—	—	—
	SEER2			16.5	14.5	15.0	14.3
EER2			12.0	9.5	10.5	9.0	
HSPF2			9.0	9.0	8.5	8.5	
COP			4.23	3.72	4.62	3.78	
Indoor Unit	Air Flow Rate - Cooling (Quiet-Lo-Med-High-SHigh)	Dry	CFM	530–565–600–670	565–600–635–705	775–850–920–990	810–885–955–1025
		Wet	CFM	495–530–565–635	530–565–600–670	705–775–850–920	740–810–885–955
	Air Flow Rate - Heating (Quiet-Lo-Med-High-SHigh)	Dry	CFM	530–565–600–670	565–600–635–705	775–850–920–990	810–885–955–1025
	Sound Pressure Level (Quiet-Lo-Med-High-SHigh)	Cooling	dB(A)	33–35–37–40	35–37–39–41	37–39–41–43	39–41–43–45
		Heating	dB(A)	33–35–37–40	35–37–39–41	37–39–41–43	39–41–43–45
	External Static Pressure		In. W.G.	—	—	—	—
	Condensate Lift Mechanism	Max Distance	In. [mm]	—	—	—	—
	Dimensions	H	In. [mm]	9-1/16 [230]	9-1/16 [230]	9-1/16 [230]	9-1/16 [230]
		W	In. [mm]	50-3/8 [1280]	50-3/8 [1280]	63 [1600]	63 [1600]
		D	In. [mm]	26-3/4 [680]	26-3/4 [680]	26-3/4 [680]	26-3/4 [680]
Weight	lbs [kg]		71 [32]	71 [32]	79 [36]	86 [39]	
Outdoor Unit	MCA	A		19.0	19.0	25.0	25.0
	MOCP	A		26	26	31	31
	Dimensions	H	In. [mm]	37-1/8 [943]	37-1/8 [943]	52-11/16 [1338]	52-11/16 [1338]
		W	In. [mm]	37-13/32 [950]	37-13/32 [950]	41-5/16 [1050]	41-5/16 [1050]
		D	In. [mm]	13 (+1-3/16) [330 (+30)]	13 (+1-3/16) [330 (+30)]	13 (+1-3/16) [330 (+30)]	13 (+1-3/16) [330 (+30)]
	Weight	lbs [kg]		153 [69]	153 [69]	214 [97]	214 [97]
	Air Flow Rate (Cooling/Heating)	CFM		1940/1940	1940/1940	3880/3880	3880/3880
	Sound Pressure Level	Cooling	dB(A)	47	47	52	52
Heating		dB(A)	48	48	53	53	
Piping	Diameter	Gas (O.D.)	In. [mm]	5/8 [15.88]	5/8 [15.88]	5/8 [15.88]	5/8 [15.88]
		Liquid (O.D.)	In. [mm]	3/8 [9.52]	3/8 [9.52]	3/8 [9.52]	3/8 [9.52]
		Indoor Drain	In. [mm]	1-1/32 [26]	1-1/32 [26]	1-1/32 [26]	1-1/32 [26]
	Max. Length	ft [m]		165 [50]	165 [50]	165 [50]	165 [50]
Max. Height	ft [m]		100 [30]	100 [30]	100 [30]	100 [30]	
Electrical	Outdoor-Indoor ⁵	V, ph, Hz		208/230, 1, 60	208/230, 1, 60	208/230, 1, 60	208/230, 1, 60
	Recommended Breaker Size	A		25	25	30	30
Refrigerant Type				R410A	R410A	R410A	R410A
Guaranteed Temperature Operation Range	Cooling ⁶	°F DB [°C DB]		0 to 115 [-18.0 to 46.0]	0 to 115 [-18.0 to 46.0]	0 to 115 [-18.0 to 46.0]	0 to 115 [-18.0 to 46.0]
	Heating	°F DB [°C DB]		-4 to 70 [-20.0 to 21.0]	-4 to 70 [-20.0 to 21.0]	-4 to 70 [-20.0 to 21.0]	-4 to 70 [-20.0 to 21.0]

Notes:

AHRI Rated Conditions (Rated data is determined at a fixed compressor speed)

¹ Cooling (Indoor // Outdoor)	°F	80 DB, 67 WB // 95 DB, 75 WB
² Heating at 47°F (Indoor // Outdoor)	°F	70 DB, 60 WB // 47 DB, 43 WB
³ Heating at 17°F (Indoor // Outdoor)	°F	70 DB, 60 WB // 17 DB, 15 WB
⁴ Heating at 5°F (Indoor // Outdoor)	°F	70 DB, 60 WB // 5 DB, 4 WB

Conditions
⁵Indoor units receive power from outdoor units through field-supplied interconnected wiring.
⁶Wind baffles required to operate below 23°F DB in cooling mode. PUZ with wind baffle: 0° F - 115° F. Refer to wind baffle documentation for further information.

SEACOAST PROTECTION

- External Outer Panel: Phosphate coating + Acrylic-Enamel coating
- Fan Motor Support: Epoxy resin coating (at edge face)
- Separator Assembly; Valve Bed: Epoxy resin coating (at edge face)
- "Blue Fin" treatment is an anti-corrosion treatment that is applied to the condenser coil to protect it against airborne contaminants.

PCA Specifications



Hyper-heating Heat Pump

Indoor Unit				PCA-A24KA7	PCA-A30KA7	PCA-A36KA7	PCA-A42KA7
Outdoor Unit				PUZ-HA24NHA1	PUZ-HA30NKA	PUZ-HA36NKA	PUZ-HA42NKA1
AHRI Certified Reference Number				206223004	206223005	211259275	206223007
Cooling	Capacity	Rated ¹	BTU/H	23,000	30,000	34,000	42,000
	Capacity Range	Min-Max	BTU/H	10,000–24,000	14,300–30,000	14,900–34,000	16,600–42,000
	Power Input	Rated ¹	W	1,840	2,380	2,700	4,050
	Moisture Removal		Pints/h	5.6	8.3	7.9	10.6
	Sensible Heat Factor			0.730	0.690	0.740	0.720
	Sensible Heat Factor - High Latent			—	—	—	—
Heating	Capacity at 47°F	Rated ²	BTU/H	26,000	32,000	38,000	48,000
	Capacity Range	Min-Max	BTU/H	10,000–28,000	14,400–35,000	17,400–40,000	24,000–54,000
	Power Input at 47°F	Rated ²	W	2,050	2,930	3,360	4,760
	Capacity at 17°F	Rated ³	BTU/H	17,700	22,200	25,400	38,500
	Capacity at 5°F	Max ⁴	BTU/H	26,000	32,000	38,000	48,000
	Capacity at -5°F	Max ⁵	BTU/H	—	—	—	—
Efficiency	SEER2			21.6	20.2	20.0	16.3
	EER2			14.0	14.1	13.0	10.7
	HSPF2			10.0	8.8	9.0	9.0
	COP			3.71	3.2	3.31	2.95
	Air Flow Rate - Cooling (Quiet-Low-Med-High-SHigh)	Dry	CFM	530–565–600–670	565–600–635–705	775–850–920–990	810–885–955–1025
Air Flow Rate - Heating (Quiet-Low-Med-High-SHigh)	Wet	CFM	495–530–565–635	530–565–600–670	705–775–850–920	740–810–885–955	
Indoor Unit	Air Flow Rate - Heating (Quiet-Low-Med-High-SHigh)	Dry	CFM	530–565–600–670	565–600–635–705	775–850–920–990	810–885–955–1025
	Sound Pressure Level (Quiet-Low-Med-High-SHigh)	Cooling	dB(A)	33–35–37–40	35–37–39–41	37–39–41–43	39–41–43–45
	Sound Pressure Level (Quiet-Low-Med-High-SHigh)	Heating	dB(A)	33–35–37–40	35–37–39–41	37–39–41–43	39–41–43–45
	External Static Pressure		In. W.G.	—	—	—	—
	Condensate Lift Mechanism	Max Distance	In. [mm]	—	—	—	—
		H	In. [mm]	9-1/16 [230]	9-1/16 [230]	9-1/16 [230]	9-1/16 [230]
		W	In. [mm]	50-3/8 [1280]	50-3/8 [1280]	63 [1600]	63 [1600]
	Dimensions	D	In. [mm]	26-3/4 [680]	26-3/4 [680]	26-3/4 [680]	26-3/4 [680]
		Weight	lbs [kg]	71 [32]	71 [32]	79 [36]	86 [39]
	Outdoor Unit	MCA	A	17.0	24.0	24.0	36.0
MOCP		A	27	40	40	44	
Dimensions		H	In. [mm]	37-1/8 [943]	52-11/16 [1338]	52-11/16 [1338]	52-11/16 [1338]
		W	In. [mm]	37-13/32 [950]	41-5/16 [1050]	41-5/16 [1050]	41-5/16 [1050]
		D	In. [mm]	14-3/16 [360]	14-3/16 [360]	14-3/16 [360]	14-3/16 [360]
Weight		lbs [kg]	190 [86]	261 [118]	261 [118]	283 [128]	
Air Flow Rate (Cooling/Heating)		CFM	1940/1940	3880/3880	3880/3880	3319/3319	
Sound Pressure Level		Cooling	dB(A)	52	52	52	49
		Heating	dB(A)	53	53	53	51
Piping		Diameter	Gas (O.D.)	In. [mm]	5/8 [15.88]	5/8 [15.88]	5/8 [15.88]
	Liquid (O.D.)		In. [mm]	3/8 [9.52]	3/8 [9.52]	3/8 [9.52]	3/8 [9.52]
	Indoor Drain		In. [mm]	1-1/32 [26]	1-1/32 [26]	1-1/32 [26]	1-1/32 [26]
	Max. Length	ft [m]	165 [50]	245 [75]	245 [75]	245 [75]	
Max. Height	ft [m]	100 [30]	100 [30]	100 [30]	100 [30]		
Electrical	Outdoor-Indoor ⁵	V, ph, Hz	208/230, 1, 60	208/230, 1, 60	208/230, 1, 60	208/230, 1, 60	
	Recommended Breaker Size	A	25	35	35	40	
Refrigerant Type			R410A	R410A	R410A	R410A	
Guaranteed Temperature Operation Range	Cooling ⁶	°F DB [°C DB]	0 to 115 [-18.0 to 46.0]	0 to 115 [-18.0 to 46.0]	0 to 115 [-18.0 to 46.0]	0 to 115 [-18.0 to 46.0]	
	Heating	°F DB [°C DB]	-13 to 70 [-25.0 to 21.0]	-13 to 70 [-25.0 to 21.0]	-13 to 70 [-25.0 to 21.0]	-13 to 70 [-25.0 to 21.0]	

Notes:
 AHRI Rated Conditions
 (Rated data is determined at a fixed compressor speed)
 Conditions

¹Cooling (Indoor // Outdoor) °F 80 DB, 67 WB // 95 DB, 75 WB
²Heating at 47°F (Indoor // Outdoor) °F 70 DB, 60 WB // 47 DB, 43 WB
³Heating at 17°F (Indoor // Outdoor) °F 70 DB, 60 WB // 17 DB, 15 WB
⁴Heating at 5°F (Indoor // Outdoor) °F 70 DB, 60 WB // 5 DB, 4 WB

⁵Indoor units receive power from outdoor units through field-supplied interconnected wiring.
⁶Wind baffles required to operate below 23°F DB in cooling mode. PUZ with wind baffle: 0° F - 115° F.



Multi-zone Models

M-Series multi-zone outdoor units operate 2 to 8 indoor units on the same system.



Multi-Zone Product Range

Indoor Units



MSZ-FS
Wall-mounted



MSZ-EF
Wall-mounted



MSZ-GS
Wall-mounted



SVZ
Multi-position
Air Handler



EZ FIT® Recessed
Ceiling Cassette



SLZ Model
Ceiling Cassette



PLA Model
Ceiling Cassette



PCA
Ceiling Suspended



MFZ-KJ
Floor-mounted



SEZ
Horizontal-ducted



PEAD
Horizontal-ducted



intelli-HEAT™
Cased Coil

Outdoor Units

Heat Pumps



MXZ-2C20NA2
2-port Connection

Connects up to 2 Indoor Units



MXZ-3C24NA3
MXZ-3C30NA3

3-port Connection

Connects up to 3 Indoor Units



MXZ-4C36NA3
4-port Connection

Connects up to 4 Indoor Units



MXZ-5C42NA3
5-port Connection

Connects up to 5 Indoor Units

Hyper-heating INVERTER® Heat Pumps



MXZ-2C20NAHZ2
2-port Connection

Connects up to 2 Indoor Units



MXZ-3C24NAHZ2
MXZ-3C30NAHZ2

3-port Connection

Connects up to 3 Indoor Units









Verify System Compatibility

Possible combinations depend on the outdoor unit chosen. Please check the following points.

Indoor Units - Refer to the Indoor Unit Compatibility Table to check if the indoor units selected can be used with the outdoor unit selected.

If the desired combination cannot be found, please change either the indoor or outdoor unit to match one of the combinations shown in the tables. Indoor units not listed in the table cannot be used.

Multi-zone Indoor Unit Connections

	Model Name	Capacity	Wall-mounted	Floor-mounted	EZ FIT® Recessed Ceiling Cassette	Ceiling Cassette	Horizontal- ducted	Multi-position Air Handler	Ceiling- suspended	intelli-HEAT™
Heat Pump	 MXZ-2C20NA3 Up to 2 indoor units	2,000 BTU/H (1-phase)	MSZ-FH06/09/12/15 MSZ-EF09/12/15 MSZ-GL06/09/12/15	MFZ-KJ 09/12/15	MLZ-KP 09/12	SLZ-KF 09/12	SEZ-KD 09/12/15 PEAD A-12	SVZ-KP 12		
	 MXZ-3C24NA3 Up to 3 indoor units	24,000 BTU/H (1-phase)	MSZ-FH06/09/12/15/18 MSZ-EF09/12/15/18 MSZ-GL06/09/12/15/18	MFZ-KJ 09/12/15/18	MLZ-KP 09/12/18	SLZ-KF 09/12/15 PLA-A18	SEZ-KD 09/12/15/18 PEAD A-12/18	SVZ-KP 12/18		PAA 18
	 MXZ-3C30NA3 Up to 3 indoor units	30,000 BTU/H (1-phase)	MSZ-FH06/09/12/15/18 MSZ-EF09/12/15/18 MSZ- GL06/09/12/15/18/24	MFZ-KJ 09/12/15/18	MLZ-KP 09/12/18	SLZ-KF 09/12/15 PLA-A18	SEZ-KD 09/12/15/18 PEAD A-12/18/24	SVZ-KP 12/18/24	PCA-A 24	PAA 18/24
	 MXZ-4C36NA3 Up to 4 indoor units	36,000 BTU/H (1-phase)	MSZ-FH06/09/12/15/18 MSZ-EF09/12/15/18 MSZ- GL06/09/12/15/18/24	MFZ-KJ 09/12/15/18	MLZ-KP 09/12/18	SLZ-KF 09/12/15 PLA-A18	SEZ-KD 09/12/15/18 PEAD A-12/18/24	SVZ-KP 12/18/24	PCA-A 24	PAA 18/24
	 MXZ-5C42NA2 Up to 5 indoor units	42,000 BTU/H (1-phase)	MSZ-FH06/09/12/15/18 MSZ-EF09/12/15/18 MSZ- GL06/09/12/15/18/24	MFZ-KJ 09/12/15/18	MLZ-KP 09/12/18	SLZ-KF 09/12/15 PLA-A18	SEZ-KD 09/12/15/18 PEAD A-12/18/24	SVZ-KP 12/18/24	PCA-A 24	PAA 18/24
Hyper-heating	 MXZ-2C20NAHZ2 Up to 2 indoor units	20,000 BTU/H (1-phase)	MSZ-FH06/09/12/15 MSZ-EF09/12/15 MSZ-GL06/09/12/15	MFZ-KJ 09/12/15	MLZ-KP 09/12	SLZ-KF 09/12	SEZ-KD 09/12/15 PEAD A-12	SVZ-KP 12		
	 MXZ-3C24NAHZ2 Up to 3 indoor units	24,000 BTU/H (1-phase)	MSZ-FH06/09/12/15/18 MSZ-EF09/12/15/18 MSZ-GL06/09/12/15/18	MFZ-KJ 09/12/15/18	MLZ-KP 09/12/18	SLZ-KF 09/12/15 PLA-A18	SEZ-KD 09/12/15/18 PEAD A-12/18	SVZ-KP 12/18		PAA 18
	 MXZ-3C30NAHZ2 Up to 3 indoor units	30,000 BTU/H (1-phase)	MSZ-FH06/09/12/15/18 MSZ-EF09/12/15/18 MSZ- GL06/09/12/15/18/24	MFZ-KJ 09/12/15/18	MLZ-KP 09/12/18	SLZ-KF 09/12/15 PLA-A18	SEZ-KD 09/12/15/18 PEAD A-12/18/24	SVZ-KP 12/18/24	PCA-A 24	PAA 18/24



MXZ-C

Multi-zone Outdoor Unit



Multi-zone Heat Pump

The MXZ-C Model is the perfect solution for sites with limited space. One outdoor unit can handle a range of building layouts and can cool and heat up to eight rooms.

Capacities: 20,000 to 42,000 BTU/H

Sound: As low as 50 dB(A)

SEER2: Up to 20.00

HSPF2: Up to 13.60

COP: Up to 4.20



Handle Up to Five Rooms with a Single Outdoor Unit

The MXZ-C Model offers a seven-system lineup to choose from, ranging between 20,000 and 42,000 BTU/H. All of them are compatible with specific M- and P-Series indoor units. A single outdoor unit can handle a wide range of building layouts.



Optional Drain for All Models

With the MXZ-C Model, one outdoor unit can cool and heat up to eight rooms. They can be installed neatly in sites with limited space, such as condominium balconies.

MXZ-C Specifications



INVERTER-driven Multi-zone Heat Pumps

			MXZ-2C20NA4	MXZ-3C24NA4	MXZ-3C30NA4	MXZ-4C36NA4	MXZ-5C42NA4
Cooling Capacity (Nominal)	BTU/H		18,000	22,000	28,400	35,400	40,500
Heating Capacity (Nominal)	BTU/H		22,000	25,000	28,600	36,000	45,000
Guaranteed Operating Range ¹	Cooling ²	°FDB	115 / 14	115 / 14	115 / 14	115 / 14	115 / 14
	Heating ³	°FDB	65 / 5	65 / 5	65 / 5	65 / 5	65 / 5
External Dimensions (H x W x D)	In. [mm]		27-15/16 x 33-1/16 x 13 [710 x 840 x 330]	31-11/32 x 37-13/32 x 13 [796 x 950 x 330]	31-11/32 x 37-13/32 x 13 [796 x 950 x 330]	31-11/32 x 37-13/32 x 13 [796 x 950 x 330]	41-17/64 x 37-13/32 x 13 [1,048 x 950 x 330]
Net Weight	Lbs. [kg]		126 [57]	137 [62]	137 [62]	139 [63]	189 [86]
Electrical Power Requirements	Voltage, Phase, Hertz		208/230, 1, 60	208/230, 1, 60	208/230, 1, 60	208/230, 1, 60	208/230, 1, 60
Minimum Circuit Ampacity	A		17.2	22.1	22.1	23.1	32.5
Maximum Overcurrent Protection	A		20	25	25	25	40
Recommended Fuse Size	A		20	25	25	25	40
Recommended Minimum Wire Size	AWG [mm]		14	14	14	14	14
SCCR	kA		5	5	5	5	5
Refrigerant Piping Diameter	Liquid (High Pressure)	In. [mm]	A,B: 1/4 [A,B: 6.35]	A,B,C: 1/4 [A,B,C: 6.35]	A,B,C: 1/4 [A,B,C: 6.35]	A,B,C,D: 1/4 [A,B,C,D: 6.35]	A,B,C,D,E: 1/4 [A,B,C,D,E: 6.35]
	Gas (Low Pressure)	In. [mm]	A,B: 3/8 [A,B: 9.52]	A: 1/2; B,C: 3/8 [A: 12.72; B,C: 9.52]	A: 1/2; B,C: 3/8 [A: 12.72; B,C: 9.52]	A: 1/2; B,C,D: 3/8 [A: 12.72; B,C,D: 9.52]	A: 1/2; B,C,D,E: 3/8 [A: 12.72; B,C,D,E: 9.52]
Max. Total Refrigerant Line Length	Ft. [m]		() [()]	() [()]	() [()]	() [()]	() [()]
Max. Refrigerant Line Length (Between ODU & IDU)	Ft. [m]		164 () [50 ()]	230 () [70 ()]	230 () [70 ()]	230 () [70 ()]	262 () [80 ()]
Indoor Unit Connectable	Total Capacity		12,000 ()~24,000	12,000 ()~27,000	12,000 ()~36,000	12,000 ()~42,000	12,000 ()~51,000
	Indoor Unit Quantity	M- and P-Series	2~2 ()	2~3 ()	2~3 ()	2~4 ()	2~5 ()
		CITY MULTI	~	~	~	~	~
Sound Pressure Levels		dB(A)	50/54	51/55	52/56	54/56	56/58
Sound Power Levels		dB(A)	54	55	56	56	58
FAN ⁴	Airflow Rate	CFM	1,342/1,458	2,287/2,382	2,287/2,382	2,287/2,382	2,150/2,550
Compressor	Type		DC INVERTER-driven Twin Rotary	DC INVERTER-driven Twin Rotary	DC INVERTER-driven Twin Rotary	DC INVERTER-driven Twin Rotary	DC INVERTER-driven Twin Rotary
Lubricant			NEO22 // 20.3	FV50S // 23.7	FV50S // 23.7	FV50S // 23.7	FV50S // 37.2
AHRI Ratings (Ducted // Mixed // Non-ducted)	EER		12.7 // 11.35 // 10.0	13.58 // 12.41 // 11.24	10.6 // 10.12 // 9.65	9.41 // 9.07 // 8.73	9.2 // 9.1 // 9.0
	SEER		20.0 // 18.0 // 16.0	20.0 // 18.0 // 16.0	19.0 // 17.6 // 16.2	19.2 // 17.6 // 16.0	19.7 // 17.4 // 15.2
	COP		3.93 // 3.78 // 3.64	4.19 // 3.99 // 3.8	3.9 // 3.77 // 3.65	3.5 // 3.37 // 3.25	3.69 // 3.58 // 3.47
	HSPF		10.0 // 9.65 // 9.3	10.0 // 9.5 // 9.2	10.6 // 10.1 // 9.6	11.0 // 10.4 // 9.8	10.3 // 9.7 // 9.1
	ENERGY STAR [®] Certified		Yes // No // No	Yes // No // No	No // No // No	No // No // No	No // No // No

NOTES:

AHRI Rated Conditions (Rated data is determined at a fixed compressor speed)

¹Cooling (Indoor // Outdoor) °F 80 DB, 67 WB // 95 DB, 75 WB

²Heating at 47°F (Indoor // Outdoor) °F 70 DB, 60 WB // 47 DB, 43 WB

³Heating at 17°F (Indoor // Outdoor) °F 70 DB, 60 WB // 17 DB, 15 WB

Conditions ⁴Heating at 5°F (Indoor // Outdoor) °F 70 DB, 60 WB // 5 DB, 4 WB

*Applications should be restricted to comfort cooling only; equipment cooling applications are not recommended for low ambient temperature conditions.

^A when 1 or more PLA-A-EA7 connected

^B Branch box should be placed within the level between the outdoor unit and indoor units

^C 5°F DB - 115°F DB when optional wind baffles are installed

For actual capacity performance based on indoor unit type and number of indoor units connected, please refer to MXZ Operational Performance.

Although the maximum connectable capacity is 130%, the outdoor unit cannot provide more than 100% of the rated capacity. Please utilize this over capacity capability for load shedding or applications where it is known that all connected units will NOT be operating at the same time.

MXZ-NAHZ

Multi-zone Outdoor Heat Pump



Multi-zone Hyper-heating Heat Pump

Connect up to eight different indoor units from the M-Series to just one MXZ outdoor unit to provide optimal heating and air conditioning that meets the requirements of every room.

Capacities: 20,000 to 30,000 BTU/H

Sound: As low as 54 dB(A)

SEER2: Up to 19.00

HSPF2: Up to 13.50

COP: Up to 4.24

ENERGY STAR®: Some systems



Hyper-heating INVERTER®

Standard-rated heating capacity is maintained even when the outside air temperature drops to 5° F. The hyper-heating INVERTER maintains high capacity output even when the outside air temperature is low.



Operates as Low as -13° F Outside air Temperature

This unit features key parts that are resistant to cold of up to -13° F after rigorous selection. The printed circuit board is coated on both sides to protect it in harsh environments.

MXZ-NAHZ Specifications

Hyper-heating Multi-zone Heat Pumps

			MXZ-2C20NAHZ4	MXZ-3C24NAHZ4	MXZ-3C30NAHZ4
Cooling Capacity (Nominal)		BTU/H	18,000	22,000	28,400
Heating Capacity (Nominal)		BTU/H	22,000	25,000	28,600
Guaranteed Operating Range ¹	Cooling ²	°FDB	115 / 14	115 / 14	115 / 14
	Heating ³	°FDB	65 / -13	65 / -13	65 / -13
External Dimensions (H x W x D)	In. [mm]		41-17/64 x 37-13/32 x 13 [1,048 x 950 x 330]	41-17/64 x 37-13/32 x 13 [1,048 x 950 x 330]	41-17/64 x 37-13/32 x 13 [1,048 x 950 x 330]
Net Weight		Lbs. [kg]	187 [85]	189 [86]	189 [86]
Electrical Power Requirements	Voltage, Phase, Hertz		208/230, 1, 60	208/230, 1, 60	208/230, 1, 60
Minimum Circuit Ampacity		A	29.5	30.5	30.5
Maximum Overcurrent Protection		A	40	40	40
Recommended Fuse Size		A	40	40	40
Recommended Minimum Wire Size		AWG [mm]	14	14	14
SCCR		kA	5	5	5
Refrigerant Piping Diameter	Liquid (High Pressure)	In. [mm]	A,B: 1/4 [A,B: 6.35]	A,B,C: 1/4 [A,B,C: 6.35]	A,B,C: 1/4 [A,B,C: 6.35]
	Gas (Low Pressure)	In. [mm]	A,B: 3/8 [A,B: 9.52]	A: 1/2; B,C: 3/8 [A: 12.72; B,C: 9.52]	A: 1/2; B,C: 3/8 [A: 12.72; B,C: 9.52]
Max. Total Refrigerant Line Length		Ft. [m]	() [()]	() [()]	() [()]
Max. Refrigerant Line Length (Between ODU & IDU)		Ft. [m]	164 () [50 ()]	230 () [70 ()]	230 () [70 ()]
Indoor Unit Connectable	Total Capacity		12,000 ()~24,000	12,000 ()~27,000	12,000 ()~36,000
	Indoor Unit Quantity	M- and P-Series	2~2 ()	2~3 ()	2~3 ()
		CITY MULTI	~	~	~
Sound Pressure Levels		dB(A)	54/58	54/58	54/58
Sound Power Levels		dB(A)	58	58	58
FAN ⁴	Airflow Rate	CFM	2,150/2,550	2,150/2,550	2,224/2,550
Compressor	Type		DC INVERTER-driven Twin Rotary	DC INVERTER-driven Twin Rotary	DC INVERTER-driven Twin Rotary
Lubricant			FV50S // 37.2	FV50S // 37.2	FV50S // 37.2
AHRI Ratings (Ducted // Mixed // Non-ducted)	EER		14.3 // 12.2 // 11.0	13.5 // 11.7 // 10.0	12.5 // 11.4 // 10.3
	SEER		17.1 // 16.0 // 15.0	19.0 // 17.2 // 15.5	18.0 // 17.0 // 16.0
	COP		4.37 // 3.84 // 3.69	4.25 // 4.02 // 3.8	4.0 // 3.85 // 3.7
	HSPF		10.0 // 9.6 // 9.5	10.0 // 9.5 // 9.0	11.0 // 10.4 // 9.8
	ENERGY STAR [®] Certified		Yes // No // No	Yes // No // No	Yes // No // No

NOTES:

AHRI Rated Conditions

(Rated data is determined at a fixed compressor speed)

¹Cooling (Indoor // Outdoor)

²Heating at 47°F (Indoor // Outdoor)

³Heating at 17°F (Indoor // Outdoor)

°F 80 DB, 67 WB // 95 DB, 75 WB

°F 70 DB, 60 WB // 47 DB, 43 WB

°F 70 DB, 60 WB // 17 DB, 15 WB

Conditions

⁴Heating at 5°F (Indoor // Outdoor)

°F 70 DB, 60 WB // 5 DB, 4 WB

*Applications should be restricted to comfort cooling only; equipment cooling applications are not recommended for low ambient temperature conditions.

^A when 1 or more PLA-A-EA7 connected

^B Branch box should be placed within the level between the outdoor unit and indoor units

^C 5°F DB - 115°F DB when optional wind baffles are installed

For actual capacity performance based on indoor unit type and number of indoor units connected, please refer to MXZ Operational Performance.

Although the maximum connectable capacity is 130%, the outdoor unit cannot provide more than 100% of the rated capacity. Please utilize this over capacity capability for load shedding or applications where it is known that all connected units will NOT be operating at the same time.

M-Series Indoor/Outdoor Unit Compatibility

		Outdoor Unit	MXZ-2C20NA2	MXZ-3C24NA2	MXZ-3C30NA2	MXZ-4C36NA2	MXZ-5C42NA2	
M-Series		Indoor Unit						
	Wall-mounted	MSZ-FH06NA	•	•	•	•	•	
		MSZ-FH09NA	•	•	•	•	•	
		MSZ-FH12NA	•	•	•	•	•	
		MSZ-FH15NA	•	•	•	•	•	
		MSZ-FH18NA2		•	•	•	•	
		MSZ-GL06NA	•	•	•	•	•	
		MSZ-GL09NA	•	•	•	•	•	
		MSZ-GL12NA	•	•	•	•	•	
		MSZ-GL15NA	•	•	•	•	•	
		MSZ-GL18NA		•	•	•	•	
		MSZ-GL24NA			•	•	•	
		MSZ-EF09NAW(S)(B)	•	•	•	•	•	
		MSZ-EF12NAW(S)(B)	•	•	•	•	•	
		MSZ-EF15NAW(S)(B)	•	•	•	•	•	
	MSZ-EF18NAW(S)(B)		•	•	•	•		
	Floor-mounted	MFZ-KJ09NA	•	•	•	•	•	
		MFZ-KJ12NA	•	•	•	•	•	
		MFZ-KJ15NA	•	•	•	•	•	
		MFZ-KJ18NA		•	•	•	•	
	EZ FIT® Recessed Ceiling Cassette	MLZ-KY06NA	•	•	•	•	•	
		MLZ-KP09NA	•	•	•	•	•	
		MLZ-KP12NA	•	•	•	•	•	
		MLZ-KP18NA		•	•	•	•	
	Multi-position Air Handler	SVZ-KP12NA	•*2	•*2	•*2	•*2	•*2	
		SVZ-KP18NA		•*2	•*2	•*2	•*2	
		SVZ-KP24NA			•*2	•*2	•*2	
		SVZ-KP30NA				•*2	•*2	
	Four-way Ceiling Cassette	SVZ-KP36NA						
		SLZ-KF09NA	•	•	•	•	•	
		SLZ-KF12NA	•	•	•	•	•	
	Horizontal- ducted	SLZ-KF15NA		•	•	•	•	
		SEZ-KD09NA4	•	•	•	•	•	
		SEZ-KD12NA4	•	•	•	•	•	
		SEZ-KD15NA4	•	•	•	•	•	
			SEZ-KD18NA4		•	•	•	•

Information is current as of this printing. Minimum installed capacity cannot be less than 12,000 BTU/H. A minimum of two indoor units must be connected to all MXZ-C outdoor units.

*2 Only one SVZ Model can be connected.

*3 Maximum of two units can be connected unless the SPTB1 is utilized to power the indoor unit.

*4 Single unit can be connected.

*5 When the system includes even 1 unit of PLA-A-EA7, the number of the maximum connectable indoor units is decreased as follows: 3 for MXZ-4C36NAHZ, 4 for MXZ-5C42NAHZ, and 6 for MXZ-8C48NA(HZ) and MXZ-8C60NA.

*6 Maximum of 3 horizontal ducted indoor units (PEAD or SEZ) can be connected.

*7 Maximum of 2 horizontal ducted indoor units (PEAD or SEZ) can be connected.

For more information, please refer to the Service Manual, Application Note 1039 and the full compatibility chart on MyLinkDrive.com.

P-Series Indoor/Outdoor Unit Compatibility

		Outdoor Unit	MXZ-2C20NAHZ2	MXZ-3C24NAHZ2	MXZ-3C30NAHZ2	MXZ-4C36NAHZ2	MXZ-5C42NA2	
P-Series		Indoor Unit						
	Four-way Ceiling Cassette	PLA-A12EA7					•*5	
		PLA-A18EA7			•	•	•*5	
		PLA-A24EA7					•*5	
		PLA-A30EA7					•*5	
		PLA-A36EA7					•*5	
		PLA-A42EA7						
	Ceiling-suspended	PCA-A24KA7				•		
		PCA-A30KA7						
		PCA-A36KA7						
		PCA-A42KA7						
	Horizontal-ducted	PEAD-A12AA7	•*3	•*3	•*3	•*3	•*6	
		PEAD-A18AA7		•	•*3	•*3	•*6	
		PEAD-A24AA7			•	•	•*6	
		PEAD-A30AA7					•*6	
		PEAD-A36AA7					•*6	
		PEAD-A42AA7						
	intelli-HEAT™	PAA-A18AA1		•	•	•	•	•
		PAA-A18BA1		•	•	•	•	•
		PAA-A24AA1			•	•		
		PAA-A24BA1			•	•		
		PAA-A30AA1						
		PAA-A30BA1						
		PAA-A36BA1						
		PAA-A36CA1						
	PAA-A42BA1							
	PAA-A42CA1							

Information is current as of this printing. Minimum installed capacity cannot be less than 12,000 Btu/h. A minimum of two indoor units must be connected to all MXZ-C outdoor units.

*2 Only one SVZ Model can be connected.

*3 Maximum of two units can be connected unless the SPTB1 is utilized to power the indoor unit.

*4 Single unit can be connected.

*5 When the system includes even 1 unit of PLA-A-EA7, the number of the maximum connectable indoor units is decreased as follows: 3 for MXZ-4C36NAHZ, 4 for MXZ-5C42NAHZ, and 6 for MXZ-8C48NA(HZ) and MXZ-8C60NA.

*6 Maximum of 3 horizontal ducted indoor units (PEAD or SEZ) can be connected.

*7 Maximum of 2 horizontal ducted indoor units (PEAD or SEZ) can be connected.

For more information, please refer to the service manual, application 1039 and the full compatibility chart on mylinkdrive.

SMART MULTI™

MXZ-SM multi-zone outdoor units connect to M-Series, P-Series, or CITY MULTI® indoor units.



Multi-Zone Product Range

Indoor Units



MSZ-FS
Wall-mounted



MSZ-EF
Wall-mounted



MSZ-GS
Wall-mounted



SVZ
Multi-position
Air Handler



EZ FIT® Recessed
Ceiling Cassette



SLZ Model
Ceiling Cassette



PLA Model
Ceiling Cassette



PCA
Ceiling Suspended



MFZ-KJ
Floor-mounted



SEZ
Horizontal-ducted



PEAD
Horizontal-ducted



intelli-HEAT™
Cased Coil

Outdoor Units

Heat Pumps



MXZ-SM36NAM-U1
4-port Connection

Connects up to 4 Indoor Units

Branch Box Required*



MXZ-SM48NAM-U1
8-port Connection

Connects up to 8 Indoor Units

Branch Box Required*



MXZ-SM60NAM-U1
8-port Connection

Connects up to 8 Indoor Units

Branch Box Required*

Hyper-heating INVERTER® Heat Pumps



MXZ-SM36NAMHZ-U1
4-port Connection

Connects up to 4 Indoor Units

Branch Box Required*



MXZ-SM42NAMHZ-U1
5-port Connection

Connects up to 5 Indoor Units

Branch Box Required*



MXZ-SM48NAMHZ-U1
8-port Connection

Connects up to 8 Indoor Units

Branch Box Required*





Verify System Compatibility

Possible combinations depends on the outdoor unit chosen. Please check the following points.

Indoor Units - Refer to the Indoor Unit Compatibility Table to check if the indoor units selected can be used with the outdoor unit selected.

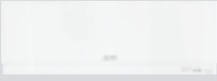
If the desired combination cannot be found, please change either the indoor or outdoor unit to match one of the combinations shown in the tables. Indoor units not listed in the table cannot be used.

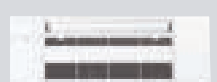
SMART MULTI™ Indoor Unit Connections

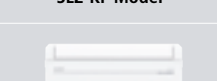
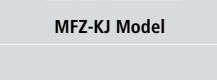
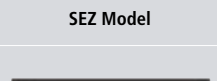
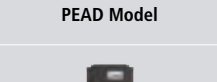
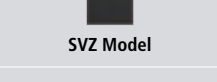
	Model	6,000 BTU/H	9,000 BTU/H	12,000 BTU/H	15,000 BTU/H	18,000 BTU/H	24,000 BTU/H	30,000 BTU/H	36,000 BTU/H
Wall-mounted	 MSZ-FS Model	•	•	•	•	•			
	 MSZ-EF Model		•	•					
	 MSZ-GL/GS Model	•	•	•	•	•	•		
EZ FIT® Recessed Ceiling Cassette	 MLZ Model	•	•	•		•			
Ceiling Cassette	 PLA Model			•		•	•	•	•
	 SLZ-KF Model		•	•	•	•			
Floor-mounted	 MFZ-KJ Model		•	•	•	•			
Horizontal-ducted	 SEZ Model		•	•	•	•			
	 PEAD Model		•	•	•	•	•	•	•
Multi-position Air Handler	 SVZ Model			•		•	•	•	•
intelli-AIR™	 PAA Cased Coil						•	•	•

MXZ-SM Multi-zone Outdoor Heat Pumps

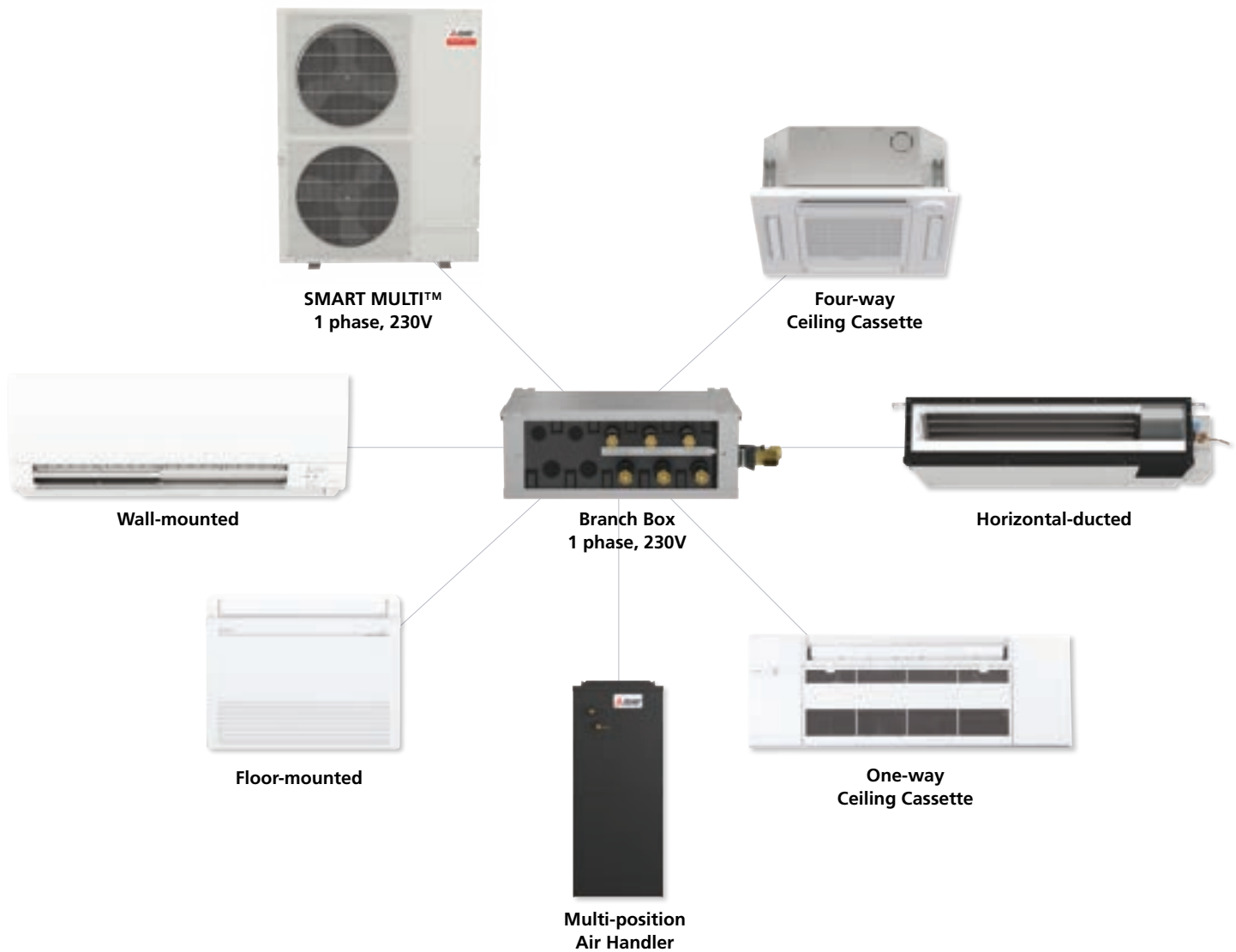

Branch Box

Type			Branch Box		
Model Name			PAC-MKA32BC	PAC-MKA52BC	
Connectible Number of Indoor Units			Maximum 3	Maximum 5	
Power Supply			1-phase, 60Hz, 208/230V	1-phase, 60Hz, 208/230V	
Input		kW	0.003	0.003	
Running Current		A	0.05	0.05	
Dimensions		W In.[mm]	17-23/32 [450]	17-23/32 [450]	
		D In.[mm]	11-1/32 [280]	11-1/32 [280]	
		H In.[mm]	6-11/16 [170]	6-11/16 [170]	
Weight		lbs [kg]	15 [6.7]	16 [7.4]	
Piping Connection (Flare)	Branch (Indoor Side)*	Gas	In.[mm]	3/8 [9.52] × 3	3/8 [9.52] × 4 1/2 [12.7] × 1
		Liquid	In.[mm]	1/4 [6.35] × 3	1/4 [6.35] × 3
	Main (Outdoor Side)*	Gas	In.[mm]	5/8 [15.88]	5/8 [15.88]
		Liquid	In.[mm]	3/8 [9.52]	3/8 [9.52]

NOTE: The piping connection size differs according to the type and capacity of indoor units. Match the piping connection size for indoor and branch box. If the piping connection size of branch box does not match the piping connection size of indoor units, use optional different-diameter (deformed) joints to the branch box side. (Connect deformed joint directly to the branch box side.)

MXZ-SM Specifications

Heat Pump

MXZ-SM		MXZ-SM36NAM		MXZ-SM48NAM		MXZ-SM60NAM	
Cooling Capacity (Nominal)		BTU/H	36,000	48,000	60,000		
Heating Capacity (Nominal)		BTU/H	42,000	54,000	66,000		
Guaranteed Operating Range ¹	Cooling ²	°FDB	115 / 5	115 / 5	115 / 5		
	Heating ³	°FDB	59 / -13	59 / -13	59 / -13		
External Dimensions (H x W x D)		In. [mm]	52-11/16 x 41-11/32 x 13 [1,338 x 1,050 x 330]	52-11/16 x 41-11/32 x 13 [1,338 x 1,050 x 330]	52-11/16 x 41-11/32 x 13 [1,338 x 1,050 x 330]		
Net Weight		Lbs. [kg]	271 [123]	271 [123]	302 [137]		
Electrical Power Requirements		Voltage, Phase, Hertz	208/230, 1, 60	208/230, 1, 60	208/230, 1, 60		
Minimum Circuit Ampacity		A	29 (35.0)	29 (35.0)	36 (46.0)		
Maximum Overcurrent Protection		A	40 (50)	40 (50)	50 (55)		
Recommended Fuse Size		A	30 (40)	30 (40)	40 (50)		
Recommended Minimum Wire Size		AWG [mm]	8 [8.4]	8 [8.4]	6 [13.3]		
SCCR		kA	5	5	5		
Refrigerant Piping Diameter	Liquid (High Pressure)	In. [mm]	3/8 [9.52]	3/8 [9.52]	3/8 [9.52]		
	Gas (Low Pressure)	In. [mm]	5/8 [15.88]	5/8 [15.88]	3/4 [19.05]		
Max. Total Refrigerant Line Length		Ft. [m]	311 (984) [95 (300)]	311 (984) [95 (300)]	311 (492) [95 (150)]		
Max. Refrigerant Line Length (Between ODU & IDU)		Ft. [m]	492 (492) [150 (150)]	492 (492) [150 (150)]	492 (262) [150 (80)]		
Indoor Unit Connectable	Total Capacity		12,000 (18,000)~46,800	12,000 (24,000)~62,000	12,000 (30,000)~78,000		
	Indoor Unit Quantity	M- and P-Series	2~4 (3)	2~8 (6)	2~8 (6)		
		CITY MULTI	1~11	1~12	1~12		
Sound Pressure Levels		dB(A)	49/53	51/54	58/59		
Sound Power Levels		dB(A)	53	54	59		
FAN ⁴	Fan Motor Output	kW	0.074+0.074	0.074+0.074	0.2+0.2		
	Airflow Rate	CFM	3,885/3,885	3,885/3,885	4,875/4,555		
Compressor		Type	Hermetic	Hermetic	Hermetic		
Compressor Motor Output		kW	2.8	3.4	3.9		
Lubricant			FV50S // 78	FV50S // 78	FVC68D // 78		
AHRI Ratings (Ducted // Mixed // Non-ducted)	EER		15.0 // 13.8 // 12.6	13.1 // 12.2 // 11.3	13.3 // 12.2 // 11.1		
	SEER		23.0 // 20.65 // 18.3	23.0 // 19.75 // 16.5	20.0 // 18.9 // 17.8		
	COP		4.0 // 3.85 // 3.7	4.0 // 3.65 // 3.3	4.1 // 3.9 // 3.7		
	HSPF		12.5 // 11.8 // 11.2	12.0 // 11.5 // 11.0	12.0 // 11.3 // 10.7		
	ENERGY STAR [®] Certified		Yes // No // Yes	Yes // No // No	Yes // No // No		

NOTES:

AHRI Rated Conditions
(Rated data is determined at a fixed compressor speed)

¹Cooling (Indoor // Outdoor)

²Heating at 47°F (Indoor // Outdoor)

³Heating at 17°F (Indoor // Outdoor)

°F 80 DB, 67 WB // 95 DB, 75 WB

°F 70 DB, 60 WB // 47 DB, 43 WB

°F 70 DB, 60 WB // 17 DB, 15 WB

Conditions

⁴Heating at 5°F (Indoor // Outdoor)

°F 70 DB, 60 WB // 5 DB, 4 WB

*Applications should be restricted to comfort cooling only; equipment cooling applications are not recommended for low ambient temperature conditions.

^A when 1 or more PLA-A-EA7 connected

^B Branch box should be placed within the level between the outdoor unit and indoor units

^C 5°F DB - 115°F DB when optional wind baffles are installed

For actual capacity performance based on indoor unit type and number of indoor units connected, please refer to MXZ Operational Performance.

Although the maximum connectable capacity is 130%, the outdoor unit cannot provide more than 100% of the rated capacity. Please utilize this over capacity capability for load shedding or applications where it is known that all connected units will NOT be operating at the same time.

MXZ-SM Specifications

Hyper-heating Heat Pumps

MXZ-SM			MXZ-SM36NAMHZ	MXZ-SM42NAMHZ	MXZ-SM48NAMHZ
Cooling Capacity (Nominal)		BTU/H	36,000	42,000	48,000
Heating Capacity (Nominal)		BTU/H	42,000	48,000	54,000
Guaranteed Operating Range ¹	Cooling ²	°FDB	115 / 5	115 / 5	115 / 5
	Heating ³	°FDB	59 / -13	59 / -13	59 / -13
External Dimensions (H x W x D)		In. [mm]	52-11/16 x 41-11/32 x 13 [1,338 x 1,050 x 330]	52-11/16 x 41-11/32 x 13 [1,338 x 1,050 x 330]	52-11/16 x 41-11/32 x 13 [1,338 x 1,050 x 330]
Net Weight		Lbs. [kg]	278 [126]	278 [126]	278 [126]
Electrical Power Requirements		Voltage, Phase, Hertz	208/230, 1, 60	208/230, 1, 60	208/230, 1, 60
Minimum Circuit Ampacity		A	36 (42.0)	36 (42.0)	36 (42.0)
Maximum Overcurrent Protection		A	40 (50)	40 (50)	40 (50)
Recommended Fuse Size		A	40 (45)	40 (45)	40 (45)
Recommended Minimum Wire Size		AWG [mm]	6 [13.3]	6 [13.3]	6 [13.3]
SCCR		kA	5	5	5
Refrigerant Piping Diameter	Liquid (High Pressure)	In. [mm]	3/8 [9.52]	3/8 [9.52]	3/8 [9.52]
	Gas (Low Pressure)	In. [mm]	5/8 [15.88]	5/8 [15.88]	5/8 [15.88]
Max. Total Refrigerant Line Length		Ft. [m]	311 (984) [95 (300)]	311 (984) [95 (300)]	311 (984) [95 (300)]
Max. Refrigerant Line Length (Between ODU & IDU)		Ft. [m]	492 (492) [150 (150)]	492 (492) [150 (150)]	492 (492) [150 (150)]
Indoor Unit Connectable	Total Capacity		12,000 (18,000)~46,800	12,000 (21,000)~54,000	12,000 (24,000)~62,000
	Indoor Unit Quantity	M- and P-Series	2~4 (3)	2~5 (4)	2~8 (6)
		CITY MULTI	1~11	1~12	1~12
Sound Pressure Levels		dB(A)	49/53	50/54	51/54
Sound Power Levels		dB(A)	53	54	54
FAN ⁴	Fan Motor Output	kW	0.074+0.074	0.074+0.074	0.074+0.074
	Airflow Rate	CFM	3,885/3,885	3,885/3,885	3,885/3,885
Compressor		Type	Hermetic	Hermetic	Hermetic
Compressor Motor Output		kW	2.8	2.9	3.4
Lubricant			FV50S // 73	FV50S // 73	FV50S // 73
AHRI Ratings (Ducted // Mixed // Non-ducted)	EER		15.0 // 13.8 // 12.6	13.4 // 12.2 // 11.0	13.1 // 12.2 // 11.3
	SEER		23.0 // 20.65 // 18.3	22.0 // 20.0 // 18.0	23.0 // 19.75 // 16.5
	COP		4.0 // 3.85 // 3.7	4.1 // 3.75 // 3.4	4.0 // 3.65 // 3.3
	HSPF		12.5 // 12.1 // 11.7	12.0 // 11.5 // 11.0	12.0 // 11.5 // 11.0
	ENERGY STAR [®] Certified		Yes // No // Yes	Yes // No // No	Yes // No // No

NOTES:

AHRI Rated Conditions
(Rated data is determined at a fixed compressor speed)

¹Cooling (Indoor // Outdoor)

°F 80 DB, 67 WB // 95 DB, 75 WB

²Heating at 47°F (Indoor // Outdoor)

°F 70 DB, 60 WB // 47 DB, 43 WB

³Heating at 17°F (Indoor // Outdoor)

°F 70 DB, 60 WB // 17 DB, 15 WB

Conditions

⁴Heating at 5°F (Indoor // Outdoor)

°F 70 DB, 60 WB // 5 DB, 4 WB

*Applications should be restricted to comfort cooling only; equipment cooling applications are not recommended for low ambient temperature conditions.

^A when 1 or more PLA-A-EA7 connected

^B Branch box should be placed within the level between the outdoor unit and indoor units

^C 5°F DB - 115°F DB when optional wind baffles are installed

For actual capacity performance based on indoor unit type and number of indoor units connected, please refer to MXZ Operational Performance.

Although the maximum connectable capacity is 130%, the outdoor unit cannot provide more than 100% of the rated capacity. Please utilize this over capacity capability for load shedding or applications where it is known that all connected units will NOT be operating at the same time.

Addendix



Piping Installation

M-Series

Single Type

Series	Outdoor Unit Class	Maximum Piping Length (ft)	Maximum Height Difference (ft)	Maximum Number of Bends
		Total Length (A)	Outdoor Unit - Indoor Unit (H)	Total Number
MUZ-FS	06/09/12	65	40	10
	15/18	100	50	10
MUZ/Y-GS	09/12/15	65	40	10
	18/24	100	50	10
MUZ-HM	09/12/15/18	65	40	10
	24	100	50	10
MUFZ-KJ	09/12	65	40	10
	15/18	100	50	10
MUZ-WR	09/12/18	65	40	10
	24	100	50	10
SUZ-KA-NA2/NAHZ	09/12/15	65	40	10
	18	100	50	10
	24/30/36	100	100	10

P-Series

Single Type

Series	Outdoor Unit Class	Maximum Piping Length (ft)	Maximum Height Difference (ft)	Maximum Number of Bends
		Total Length (A)	Outdoor Unit - Indoor Unit (H)	Total Number
PUY	12/18	165	100	15
	24/30/36/42	225	100	15
PUZ	12/18	100	100	15
	24/30/36/42	165	100	15
PUZ-HA	24	165	100	15
PUZ-HA	30/36/42	245	100	15

Additional M-Series Information

Port Adapters Parts Numbers

Model	Diameter A	Diameter B
MAC-A454JP-E	3/8"	1/2"
MAC-A455JP-E	1/2"	3/8"
MAC-A456JP-E	1/2"	5/8"
PAC-5G76RJ-E	3/8"	5/8"
ADP5834	5/8"	3/4"
PAC-493PI	1/4"	3/8"

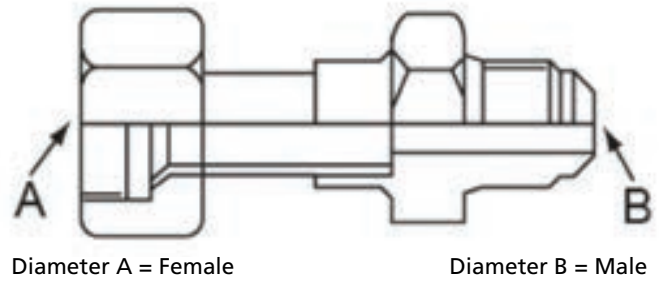

Multi-zone Efficiency Ratings

Model	Configuration	SEER2	EER2	HSPF2
MXZ-2C20NA4	Ducted	16.00	10.00	9.10
	Mixed	18.00	11.35	10.50
	Non-ducted	20.00	12.70	12.00
MXZ-3C24NA4	Ducted	16.00	11.20	8.60
	Mixed	18.00	12.40	9.30
	Non-ducted	20.00	13.60	10.00
MXZ-3C30NA4	Ducted	16.20	9.60	8.80
	Mixed	17.60	10.10	9.40
	Non-ducted	19.00	10.60	10.00
MXZ-4C36NA4	Ducted	16.00	8.70	9.50
	Mixed	17.60	9.05	9.65
	Non-ducted	19.20	9.40	9.80
MXZ-5C42NA4	Ducted	15.20	9.00	9.00
	Mixed	17.45	9.10	9.10
	Non-ducted	19.70	9.20	9.20
MXZ-2C20NAHZ4	Ducted	16.00	11.00	8.70
	Mixed	16.50	12.25	9.35
	Non-ducted	17.00	13.50	10.00
MXZ3C24NAHZ4	Ducted	15.50	10.00	8.50
	Mixed	17.25	11.75	9.25
	Non-ducted	19.00	13.50	10.00
MXZ-3C30NAHZ4	Ducted	16.00	10.30	8.50
	Mixed	17.00	11.40	9.25
	Non-ducted	18.00	12.50	10.00

M-Series Air Outlet Coverage Range*

Model	Mode	Function	Airflow (CFM)	Coverage (FT)
MSZ-FS06NA, MSZ-FS09NA	Heat	Dry	437	29.8
	Cool	Wet	328	22.5
MSZ-FS12NA	Heat	Dry	454	31.0
	Cool	Wet	364	24.8
MSZ-FS15NA	Heat	Dry	514	34.9
	Cool	Wet	376	25.6
MSZ-FS18NA	Heat	Dry	514	34.9
	Cool	Wet	376	25.6
MSZ-GS06NA, MSZ/Y-GS09NA, MSZ/Y-GS12NA	Heat	Dry	406	29.5
	Cool	Wet	286	21.0
MSZ/Y-GS15NA	Heat	Dry	463	33.5
	Cool	Wet	385	28.0
MSZ/Y-GS18NA	Heat	Dry	646	44.0
	Cool	Wet	581	39.7
MSZ/Y-GS24NA	Heat	Dry	738	36.9
	Cool	Wet	661	33.2
MSZ/Y-GS30NA, MSZ/Y-GS36NA	Heat	Dry	848	45.0
	Cool	Wet	763	40.7
MFZ-KJ09NA, MFZ-KJ12NA	Heat	Dry	417	29.6
	Cool	Wet	354	25.3
MFZ-KJ15NA	Heat	Dry	470	33.3
	Cool	Wet	366	26.2
MFZ-KJ18NA	Heat	Dry	470	33.3
	Cool	Wet	417	29.7
SLZ-KF09NA	Heat	Dry	300	15.1
	Cool	Wet	270	13.7
SLZ-KF12NA	Heat	Dry	336	16.9
	Cool	Wet	302	15.2
SLZ-KF15NA	Heat	Dry	405	20.3
	Cool	Wet	365	18.3
SLZ-KF18NA	Heat	Dry	475	23.7
	Cool	Wet	429	21.4
MSZ-EF09NA(B/S/W)	Heat	Dry	420	29.2
	Cool	Wet	319	22.3
MSZ-EF12NA(B/S/W)	Heat	Dry	448	31.1
	Cool	Wet	319	22.3
MSZ-EF15NA(B/S/W)	Heat	Dry	448	31.1
	Cool	Wet	313	21.9
MSZ-EF18NA(B/S/W)	Heat	Dry	466	32.3
	Cool	Wet	334	23.4
MSZ-HM09NA, MSZ-HM12NA	Heat	Dry	406	29.5
	Cool	Wet	286	21.0
MSZ-HM15NA	Heat	Dry	463	33.5
	Cool	Wet	385	28.0
MSZ-HM18NA	Heat	Dry	625	42.6
	Cool	Wet	562	38.4
MSZ-HM24NA	Heat	Dry	702	47.7
	Cool	Wet	632	43.1
MSZ-JP09WA	Heat	Dry	406	29.5
	Cool	Wet	364	26.5
MSZ-JP12WA	Heat	Dry	406	29.5
	Cool	Wet	364	26.5
MSZ-WR09NA	Heat	Dry	406	29.5
	Cool	Wet	286	21.0
MSZ-WR12NA	Heat	Dry	406	29.5
	Cool	Wet	286	21.0
MSZ-WR18NA	Heat	Dry	625	42.6
	Cool	Wet	562	38.4
MSZ-WR24NA	Heat	Dry	702	47.7
	Cool	Wet	632	43.1
MLZ-KP09NA	Heat	Dry	311	20.7
	Cool	Wet	325	21.7
MLZ-KP12NA	Heat	Dry	332	22.1
	Cool	Wet	350	23.3
MLZ-KP18NA	Heat	Dry	403	26.7
	Cool	Wet	417	27.6

MXZ-C Piping Lengths

MXZ-2C20NA3

Maximum Piping Length (ft)	
Outdoor Unit - Indoor Unit (a,b)	82
Total Length (a+b)	164

Maximum Number of Bends	
Outdoor Unit - Indoor Unit (a,b)	25
Total Length (a+b)	50

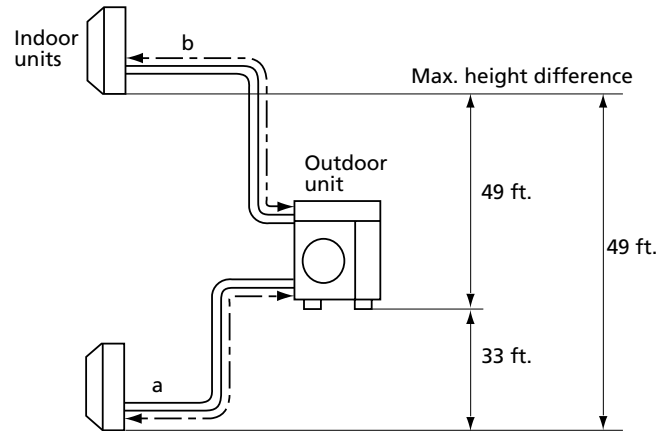

MXZ-2C20NAH22

Maximum Piping Length (ft)	
Outdoor Unit - Indoor Unit (a,b)	82
Total Length (a+b)	164

Maximum Number of Bends	
Outdoor Unit - Indoor Unit (a,b)	25
Total Length (a+b)	50

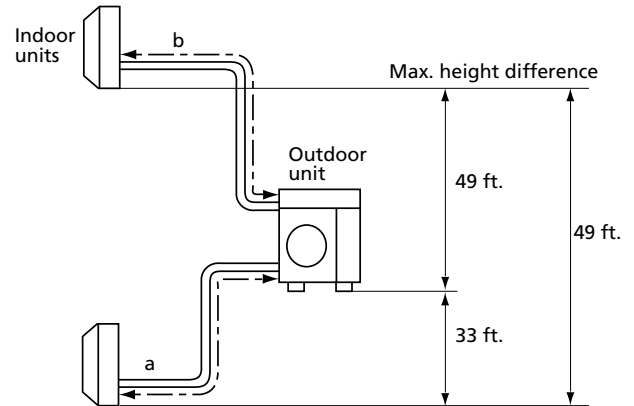

MXZ-3C24NA3, MXZ-3C24NA3, MXZ-3C30NA2, MXZ-3C24NAH22, MXZ-3C30NAH22

Maximum Piping Length (ft)	
Outdoor Unit - Indoor Unit (a,b)	82
Total Length (a+b)	164

Maximum Number of Bends	
Outdoor Unit - Indoor Unit (a,b)	25
Total Length (a+b)	50

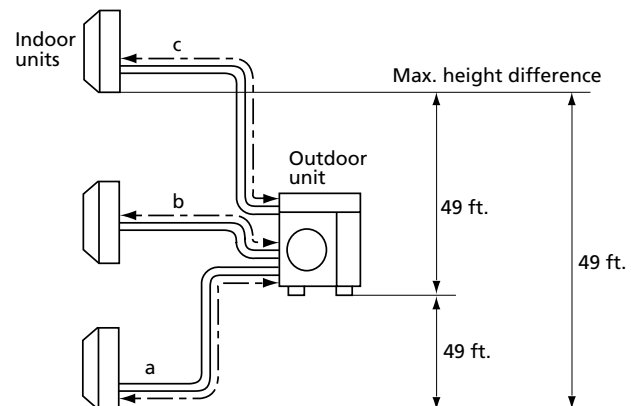

MXZ-4C36NA3

Maximum Piping Length (ft)	
Outdoor Unit - Indoor Unit (a,b)	82
Total Length (a+b)	230

Maximum Number of Bends	
Outdoor Unit - Indoor Unit (a,b)	25
Total Length (a+b)	70

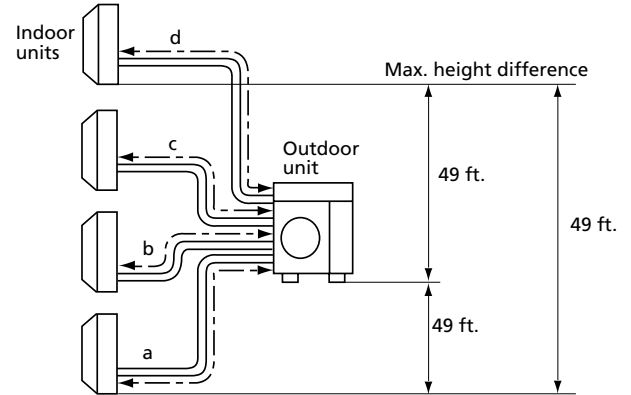

MXZ-5C42NA3

Maximum Piping Length (ft)	
Outdoor Unit - Indoor Unit (a,b)	82
Total Length (a+b)	262

Maximum Number of Bends	
Outdoor Unit - Indoor Unit (a,b)	25
Total Length (a+b)	80

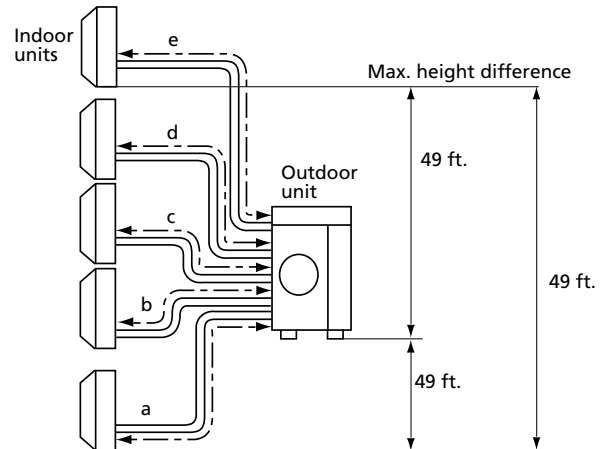

MXZ-SM Piping Lengths

MXZ-SM36NAMZ-U1, MXZ-SM42NAMZ-U1, MXZ-SM48NAMZ-U1, MXZ-SM48NAM-U1, MXZ-SM60NAM-U1

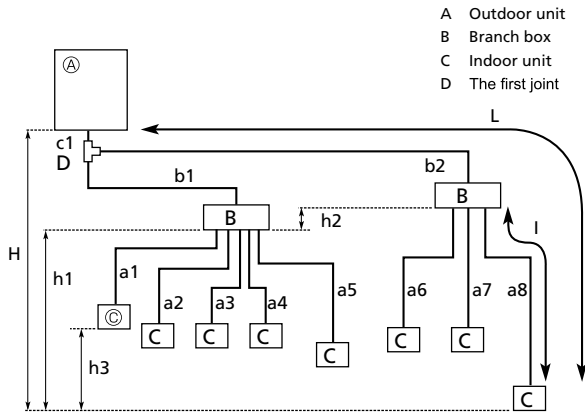

Permissible Length (One-way)	Total Piping Length	$c1 + b1 + b2 + a1 + a2 + a3 + a4 + a5 + a6 + a7 + a8 \leq 150 \text{ m (492 ft.)}$
	Farthest piping length (L) *1	$c1 + b2 + a8 \leq 80 \text{ m (262 ft.)}$
	Piping length between outdoor unit and branch boxes	$c1 + b1 + b2 \leq 55 \text{ m (180 ft.)}$
	Farthest branch box from the first joint (b2)	$b2 \leq 30 \text{ m (98 ft.)}$
	Farthest piping length after branch box (I)	$a8 \leq 25 \text{ m (82 ft.)}$
	Total piping length between branch boxes and indoor units	$a1 + a2 + a3 + a4 + a5 + a6 + a7 + a8 \leq 95 \text{ m (311 ft.)}$
Permissible Height Difference (One-way)	In indoor/outdoor section (H) *2	$H \leq 50 \text{ m (164 ft.)}$ (In case of outdoor unit is set higher than indoor unit)
	In branch box/indoor unit section (h1)	$H \leq 40 \text{ m (131 ft.)}$ (In case of outdoor unit is set lower than indoor unit)
	In each branch unit (h2)	$h1 + h2 \leq 15 \text{ m (49 ft.)}$
	In each indoor unit (h3)	$h2 \leq 15 \text{ m (49 ft.)}$
Number of Bends		$h3 \leq 12 \text{ m (39 ft.)}$
		$ c1 + b1 + a1 , c1 + b1 + a2 , c1 + b1 + a3 , c1 + b1 + a4 , c1 + b1 + a5 , c1 + b2 + a6 , c1 + b2 + a7 , c1 + b2 + a8 \leq 15$

*1 The piping specification table does not provide a minimum line set length. However, indoor units with connected piping length less than 16 ft. (5m) could produce intermittent noise during normal system operation in very quiet environments. Please be aware of this important information when installing and locating the indoor unit within the conditioned space.

*2 Branch box should be placed within the level between the outdoor unit and indoor units.

Conditions for Specifications

Cooling	Indoor	D.B. 80° F (27° C), W.B. 67° F (19° C)
	Outdoor	D.B. 95° F (35° C), W.B. 75° F (24° C)
Heating	Indoor	D.B. 70° F (21° C), W.B. 60° F (16° C)
	Outdoor	D.B. 17° F (-8° C), W.B. 15° F (-9° C)

Temperature conditions are based on AHRI 210/240.

Refrigerant piping length: 16ft. The figures for total input are based on the following voltages.

Series	Indoor Unit	Outdoor Unit
M-Series P-Series MXZ-SM	---	208/230 V Single phase 60Hz

The sound pressure measurement is conducted in an anechoic chamber. The actual sound level depends on the distance from the unit and the acoustic environment.

Terminology Explained

Maximum Piping Length

This is the maximum allowable length of the refrigerant piping. The amount of refrigerant pipe used cannot be longer than the length specified.

Total Length

The maximum allowable combined length of all the refrigerant piping between the outdoor unit and indoor unit(s).

Outdoor Unit - Indoor Unit

The maximum allowable length of the refrigerant piping between the outdoor unit and indoor units installed when multiple units are connected to a single outdoor unit. This distance limitation refers to the maximum length between the outdoor unit and the farthest indoor unit.

Pipe Length Difference From Distribution Pipe

The maximum allowable difference in refrigerant piping length from the distribution pipe to the farthest indoor unit and from the distribution pipe to the closest indoor unit when multiple indoor units are connected to a single outdoor unit using a distribution pipe.

Indoor Unit - Distribution Pipe

The maximum allowable length of the refrigerant piping between indoor units and the distribution pipe when multiple indoor units are connected to a single outdoor unit.

Maximum Height Difference

This is the maximum allowable height difference. It is necessary to install the air conditioning system so that the height distance is no more than the difference specified. (Specified differences may vary if the outdoor unit is installed higher or lower than the indoor units).

Outdoor Unit - Indoor Unit

The maximum allowable difference in height between the outdoor unit and indoor units when installed (when multiple indoor units are connected to a single outdoor unit, this distance limitation refers to the maximum height difference between the outdoor unit and an indoor unit).

Indoor Unit - Indoor Unit

The maximum allowable difference between the heights of indoor units when multiple indoor units are connected to a single outdoor unit.

Maximum Number Of Bends

This is the maximum allowable number of bends in the refrigerant piping. The total number of bends in the refrigerant piping used cannot exceed the number specified.

Total Number

The maximum allowable number of bends for all refrigerant piping between the outdoor unit and indoor units.

Outdoor Unit - Indoor Unit

The maximum allowable number of bends between the outdoor unit and each indoor unit when multiple indoor units are connected to a single outdoor unit.

Points to Remember when Installing Outdoor Units

Wind and snow can significantly reduce capacity. Be sure to check the information below and install the outdoor unit correctly.

Measure for Drainage Water

Case 1: Unit Is Installed Close To Passage (Walkway)

Do not install the unit close to passage as drainage water from the unit may freeze and cause a slipping hazard.



Wrong Installation

- Frozen drainage water may cause a slipping hazard.



Correct Installation

- Install at a sufficient height from the ground to prevent problems caused by frozen drainage water
- Install in a location where frozen drainage water will not be a hazard
- Install in an upright position to allow proper drainage from the drainage outlet

Case 2: Multiple Units Are Installed

Do not install units on top of one another as it may cause frozen drainage water on the bottom unit.

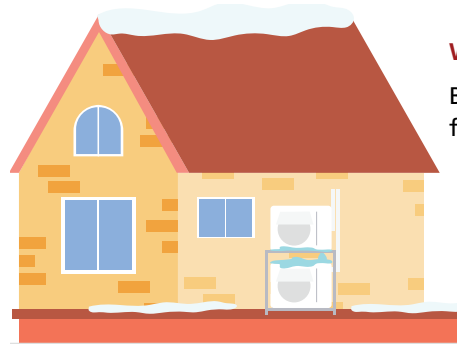

Wrong Installation

Bottom unit may freeze over



Correct Installation

Place units side by side

Installation Location

Be aware of the prevailing wind direction in winter and install the outdoor unit where it is as sheltered as possible.

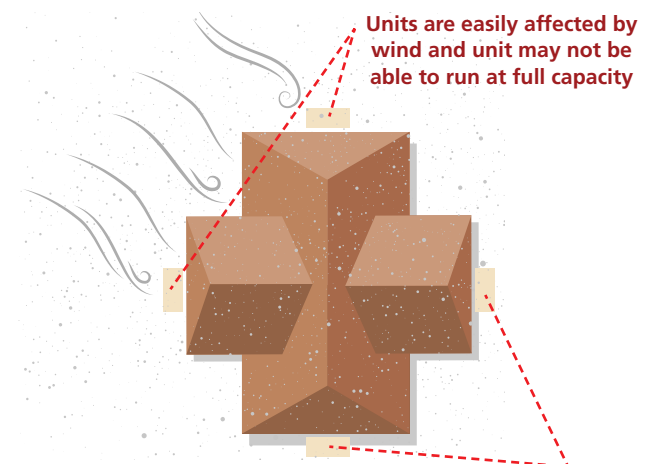

Less influence of wind and unit runs at full capacity

Measure for Snow

Do Not Install The Unit On The Ground

To avoid the adverse effects of snow and frozen drainage water, install the unit on a stand to ensure a sufficient height from the ground.



Wrong Installation

Unit may become buried in snow due to heavy snowfall, snow sliding off the roof or snowdrift



Wrong Installation

Unit may be damaged due to snowfall or icicles



Correct Installation

Install at a position/height to prevent the unit being buried in snow*1 and the adverse effects of frozen drainage water.*2 Install so as to avoid the effects of snow or snowdrift. Install so as to avoid the damage from falling snow or icicles.

*1 Install at a height above the highest snowfall depth.

*2 Even for correct installations, dripping drainage water may form an icicle which needs to be cleared away regularly to prevent a blocked drainage outlet.

Recommended Accessories

	Snowy Region	Cold Region	Remarks
	Countermeasures for Snow	Countermeasures for Freezing	
Drain Socket, Centralized Drain Pan	Not Used	Not Used	Prevents Freezing
Stand	Needed	Needed	<ol style="list-style-type: none"> 1. Install so as to prevent the unit being buried in snow (at a height greater than the highest snowfall depth). Be sure that the stand does not obstruct drainage. 2. Install so as to prevent damage to the unit due to frozen drainage water (icicles).
Snow Protection Hood	Needed *When the installation is subject to snowfall	---	<ol style="list-style-type: none"> 1. Prevents heat exchanger from being covered in snow. 2. Prevents snow accumulating inside the air duct.
Base Heater	---	Needed	Outdoor units equipped with a heater for cold regions are those with an "H" in the model name. For the cold-climate zone, use of a unit with a heater is strongly recommended. Even for the moderate-climate zone use of a unit with a heater is recommended for regions subject to high humidity in winter.

CAUTION! Drainage Water Disposal

When the unit is installed in cold or snowy regions: Drainage water may freeze in the drain socket/hose and prevent the fan from rotating. **Do not attach a drain socket packaged as an accessory to the unit.**

In the case that fitting a drain socket is absolutely necessary, steps must be taken so that the drainage water does not freeze. For more information, please consult Mitsubishi Electric Trane HVAC US or one of its dealers/resellers.

Arrangement for snow protection hood: Separately sold parts are available for some models. Please consult Mitsubishi Electric Trane HVAC US or one of its dealers/resellers at the time of purchase for details.

System Control

Versatile system controls can be achieved by using optional parts, relay circuits, control panels, etc.

For M-Series Indoor Units

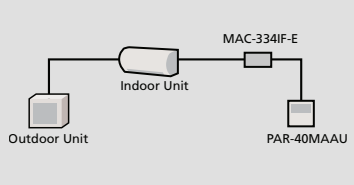
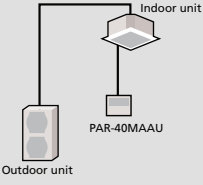
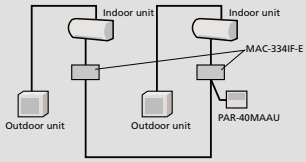
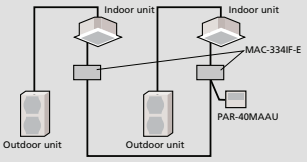
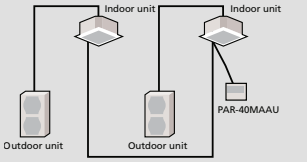
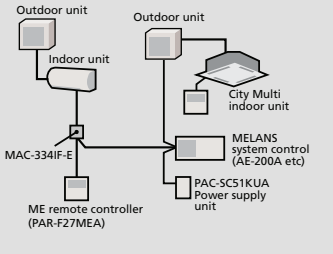
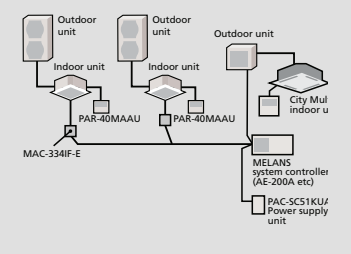
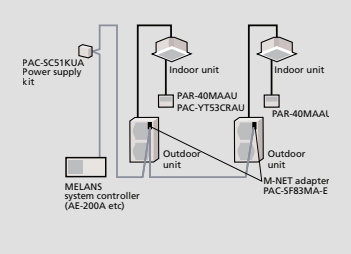
	System Examples		
Indoor Unit	M-Series	SEZ, SLZ, SVZ	P-Series
Outdoor Unit	M-Series, MXZ Series	SUZ, MXZ	P-Series
PAR-40MAAU Controller			
Details	Wired remote controller can be connected to indoor unit	Standard equipment (for indoor units compatible with wired remote controllers)	
Major Parts Required	MAC-334IF-E (Interface) PAR-40MAAU (Wired Remote Controller)	PAR-40MAAU (Wired Remote Controller)	
System Group Control			
Details	One remote controller can control plural air conditioners with the same settings simultaneously. One remote controller can control up to 16 refrigerant systems. (When connected to a MXZ unit, MAC-334IF-E is counted as one system.) Up to two remote controller can be connected.		
Major Parts Required	MAC-334IF-E (Interface) PAR-40MAAU (Wired Remote Controller)		PAR-40MAAU (Wired Remote Controller)
M-NET Connections			
Details	Group of air conditioners can be controlled by MELANS system controller (M-NET). Note: When connecting to M-NET, the reduction control for the power failure automatic recovery does not operate and it will take 3 minutes to restart.		
Major Parts Required	MAC-334IF-E (M-NET Interface), MELANS System controller, PAC-SC51KUA (Power Supply Unit)		PAC-SJ95MA-E/PAC-SJ96MA-E (M-NET Converter), MELANS System Controller, PAC-SC51KUA (Power Supply Unit)

For M-Series Indoor Units



	System Examples	Connection Details	Control Details	Major Parts Required
Remote On/Off Operation Air conditioner can be started/stopped remotely. ① and ② can be used in combination.		Connect the interface to the air conditioner. Then connect the locally purchased remote controller to the terminal in the interface.	On/Off operation is possible from a remote location.	MAC-334IF-E (Interface) Parts for circuit such as relay
Remote Display of Operation Status The On/Off status of air conditioners can be confirmed remotely. ① and ② can be used in combination.		Connect the interface to the air conditioner. Then connect the locally purchased remote controller to the terminal in the interface.	The operation status (On/Off) or error signals can be monitored from a remote location.	MAC-334IF-E (Interface) Parts for circuit to be purchased locally (DC power source needed) External power source (12V DC) is required when using MAC-334IF-E.

For P-Series, SLZ, SEZ and SVZ Indoor Units

	System Examples		Details	Major Parts Required
	Wired Remote Controller	Wireless Remote Controller		
2-remote Controller Control With two remote controllers, control can be performed locally and remotely from two locations.	<p>* Set "Main" and "Sub" remote</p>	<p>* When using wired and wireless remote control</p>	Up to two remote controllers can be connected to one group. Both wired and wireless remote controllers can be used in combination.	Wired Remote Controller: PAR-40MAAU, Wireless Remote Controller: PAR-FL32MA, Wireless Remote Controller Kit for PCA: PAR-SL93B-E
Operation Control by Level Signal The On/Off status of air Air conditioner can be started/stopped remotely. In addition, On/Off operation by local remote controller can be prohibited/permitted.	<p>(Example of 1 : 1 system x 2)</p>	<p>(Example of 1 : 1 system x 2)</p>	Operation other than On/Off (e.g., adjust-ment of temperature, fan speed, and airflow) can be performed even when remote controller operation is prohibited. Timer control is possible with an external timer.	Adapter for remote On/Off: PAC-SE55RA-E, Relay box (to be purchased locally), Remote control panel (to be purchased locally)
Operation Control by Pulse Signal	<p>(Example of 1 : 1 system x 2)</p>	<p>(Example of 1 : 1 system x 2)</p>	The pulse signal can be turned On/Off. Operation/emergency signal can be received at a remote location.	Connector cable for remote display PAC-SA88HA-E / PAC-725AD (10 pcs. x PAC-SA88HA-E), Relay box (to be purchased locally), Remote control panel (to be purchased locally)
Remote Display of Operating Status Operating status can be displayed at a remote location.	<p>(Example of 1 : 1 system)</p>	<p>(Example of Simultaneous Twin)</p>	Operation/emergency signal can be received at a remote location (when channeled through the PAC-SF40RM-E no-voltage signal, when channeled through the PAC-SA88HA-E DC 12V signal).	Remote display panel (to be purchased locally), Connector cable for remote display: PAC-SA88HA-E / PAC-725AD (10 pcs. x PAC-SA88HA-E), Relay box (to be purchased locally) Remote operation adapter: PAC-SF40RM-E *Unable to use with wireless remote controller
Timer Operation Allows On/Off operation with timer *For control by an external timer, refer to ④ Operation Control by Level Signal.	<p>(Example of 1 : 1 system)</p>		Weekly Timer: On/Off and up to 8 pattern temperatures can be set for each calendar day. (Initial setting) On/Off Timer: On/Off can be set once each within 72 hr in intervals of 5-minute units. Auto-off Timer: Operation will be switched off after a certain time elapse. Set time can be changed from 30 min. to 4 hr. at 10 min. intervals.	Standard functions of PAR-40MAAU

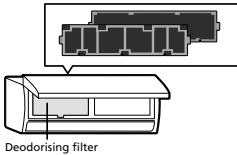
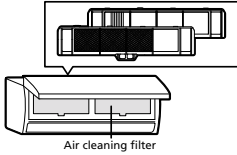
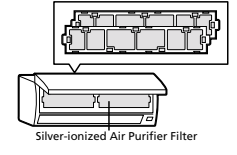
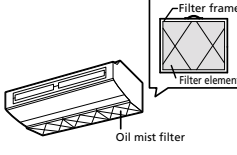
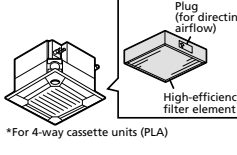
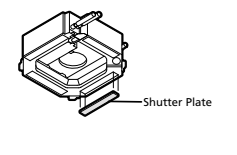
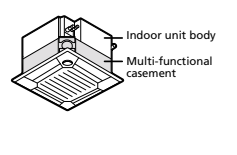
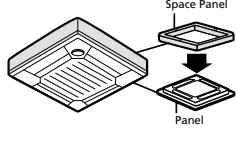
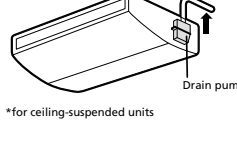
Optional Parts

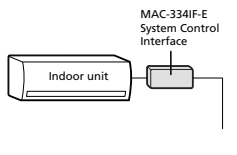
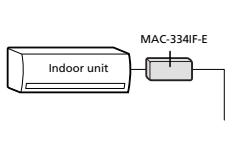
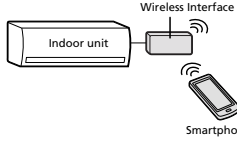
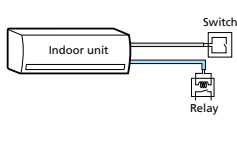
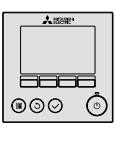
Part Name	Description
Deodorizing Filter Captures small foul-smelling substances in the air.	 <p>Deodorising filter</p>
Air cleaning Filter Removes fine dust particles from the air by means of static electricity.	 <p>Air cleaning filter</p>
Silver-ionized Air Purifier Filter Captures the bacteria, pollen and other allergens in the air and neutralizes them.	 <p>Silver-ionized Air Purifier Filter</p>
Oil Mist Filter Element Filter element (12 pieces) that blocks the oil mist for ceiling-suspended models used in professional kitchens.	 <p>Filter frame Filter element Oil mist filter</p>
High-efficiency Filter Element Element for high-efficiency filter. Removes fine dust particles from the air.	 <p>Plug (for directing airflow) High-efficiency filter element *For 4-way cassette units (PLA)</p>
Shutter Plate Plate for blocking an air outlet of the 4-way cassette (PLA) indoor unit.	 <p>Shutter Plate</p>
Multi-functional Casement Casement for fresh-air intake and attaching the high-efficiency filter element (optional).	 <p>Indoor unit body Multi-functional casement</p>
Space Panel Decorative cover for the installation when the ceiling height is low.	 <p>Space Panel Panel</p>
Drain Pump Pumps drain water to a point higher than that where the unit is installed.	 <p>Drain pump *for ceiling-suspended units</p>

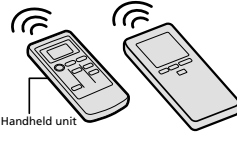
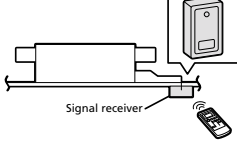
Part Name	Description
MAC-334IF-E System Control Interface Interface for connecting with the PAR-40MAAU remote controller and PACYT53CRAU, and to relay operation signals.	 <p>MAC-334IF-E System Control Interface Indoor unit</p>
Interface to connect with M-NET controllers.	 <p>MAC-334IF-E Indoor unit</p>
kumo cloud® Wireless Interface 2 Interface enabling users to control air conditioners and check operating status via devices such as personal computers, tablets and smart phones.	 <p>Wireless Interface 2 Indoor unit Smartphone</p>
CN24 Relay Kit This product is an adaptor which inputs the incoming signals from an open/close switch to the air conditioner and outputs the on/off signals from the air conditioner to the back-up heater.	 <p>Switch Indoor unit Relay</p>
Deluxe MA Wired Controller Advanced deluxe remote controller with full dot liquid-crystal display and backlight. Equipped with convenient functions like night setback.	
Simple MA Wired Controller Remote controller with liquid-crystal display, and backlight function for operation in dark location.	
Remote Controller Terminal Block Kit for PKA The terminal block is used as a relay to wire an indoor unit and to two remote controllers or to wire a remote controller and multiple indoor units in order to perform group control.	
Wireless Remote Controller Signal Sender Handheld unit for sending operation signals to the indoor unit.	 <p>Handheld unit</p>
Wireless Remote Controller Signal Receiver Receives operation signals from the wireless remote controller handheld unit.	 <p>Signal receiver</p>

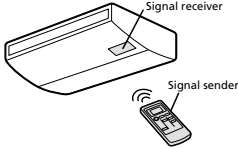
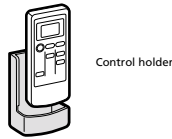
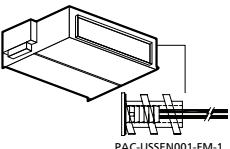
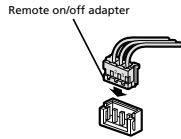
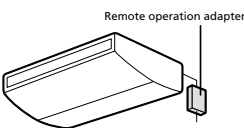
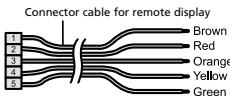
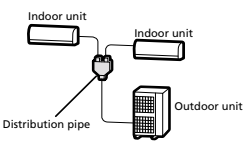
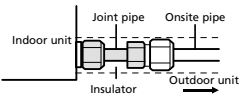
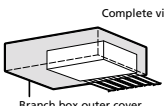
Part Name	Description
Wireless Remote Controller Kit (Sender & Receiver) Remote controller handheld unit (signal sender) and receiver (signal receiver) for ceiling-suspended units.	
Control Holder Holder for storing the remote controller.	
Remote Sensor Sensor to detect the room temperature at remote positions.	
PAC-715AD Remote On/Off Adapter Connector for receiving signals from the local system to control the on/off function.	
Remote Operation Adapter Adapter to display the operation status and control on/off function from a distance.	
PAC-725AD Connector Plug for Remote Display Connector used to display the operation status and control on/off function from a distance.	
Distribution Pipe Branch pipe for P Series simultaneous multi-system use, or to connect two branch boxes for MXZ.	 <p>*P Series with 2 indoor units</p>
Joint Pipe Part for connecting refrigerant pipes of different diameters.	
Branch Box Outer Cover Casement for branch boxes.	

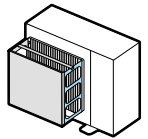
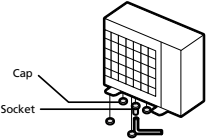
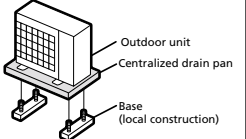
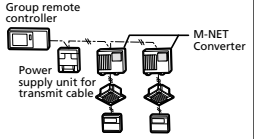
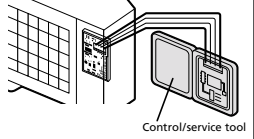
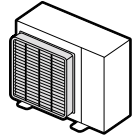
Part Name	Description
Air Protection Guide/Wind Baffle Protects the outdoor unit from the wind.	
Drain Socket A set of caps to cover unnecessary holes at the bottom of the outdoor unit, and a socket to guide drain water to the local drain pipe.	
Centralized Drain Pan Catches drain water generated by the outdoor unit.	
M-NET Converter Used to connect P Series A-control models to M-NET controllers.	
Control/Service Tool Monitoring tool to display operation and self-diagnosis data.	
Air Discharge Guide Changes the direction of air being exhausted from the outdoor unit.	

M-Series Heating Capacity

Indoor Unit	Outdoor Unit	Outdoor Temperature Degrees								
		50° F	41° F	32° F	23° F	14° F	5° F	-4° F	-5° F	-13° F
MSZ-FS06NA	MUZ-FS06NA	14,445	13,703	12,962	12,149	11,037	9,924	—	8,700	7,721
MSZ-FS09NA	MUZ-FS09NA	18,554	17,631	16,707	15,068	13,304	11,540	—	9,600	8,048
MSZ-FS12NA	MUZ-FS12NA	21,714	20,524	19,333	18,143	16,464	14,482	—	12,301	10,556
MSZ-FS15NA	MUZ-FS15NA	24,544	23,637	22,730	21,823	19,988	18,089	—	16,001	14,330
MSZ-FS18NA	MUZ-FS18NA	30,619	29,587	28,556	27,524	25,129	22,211	—	19,001	16,433
MSZ-FS06NA	MUZ-FS06NAH	14,445	13,703	12,962	12,149	11,037	9,924	—	8,700	7,721
MSZ-FS09NA	MUZ-FS09NAH	18,554	17,631	16,707	15,068	13,304	11,540	—	9,600	8,048
MSZ-FS12NA	MUZ-FS12NAH	21,714	20,524	19,333	18,143	16,464	14,482	—	12,301	10,556
MSZ-FS15NA	MUZ-FS15NAH	24,544	23,637	22,730	21,823	19,988	18,089	—	16,001	14,330
MSZ-FS18NA	MUZ-FS18NAH	30,619	29,587	28,556	27,524	25,129	22,211	—	19,001	16,433
MSZ-GS09NA	MUZ-GS09NA	16,240	15,137	13,507	11,877	10,128	8,100	5,870	—	—
MSZ-GS12NA	MUZ-GS12NA	18,596	16,085	14,809	13,533	11,961	9,700	7,214	—	—
MSZ-GS15NA	MUZ-GS15NA	21,321	18,273	17,976	17,612	16,375	13,701	10,510	—	—
MSZ-GS18NA	MUZ-GS18NA	24,509	24,088	21,840	19,593	17,208	14,501	11,523	—	—
MSZ-GS24NA	MUZ-GS24NA	38,207	34,281	30,472	26,662	22,842	19,001	14,775	—	—
MSZ-GS30NA	MUZ-GS30NA	38,122	27,568	26,201	24,833	22,712	18,859	—	—	—
MSZ-GS36NA	MUZ-GS36NA	39,401	29,292	27,873	26,453	24,330	20,562	—	—	—
MSZ-HM09NA	MUZ-HM09NA	10,900	10,570	9,480	8,500	7,300	5,990	4,680	—	—
MSZ-HM12NA	MUZ-HM12NA	12,200	12,200	11,220	10,120	9,020	7,440	5,850	—	—
MSZ-HM15NA	MUZ-HM15NA	18,000	15,300	14,940	14,400	13,680	12,240	10,620	—	—
MSZ-HM18NA	MUZ-HM18NA	18,000	18,000	18,000	16,560	14,580	12,780	10,980	—	—
MSZ-HM24NA	MUZ-HM24NA	26,000	24,440	22,360	20,020	17,680	15,600	13,260	—	—
MSZ-JP09WA	MUZ-JP09WA	10,900	10,570	9,480	8,500	7,300	5,990	4,680	—	—
MSZ-JP12WA	MUZ-JP12WA	12,200	12,200	11,220	10,120	9,020	7,440	5,850	—	—
MSZ-WR09NA	MUZ-WR09NA-U2	10,900	10,570	9,480	8,500	7,300	5,990	—	—	—
MSZ-WR12NA	MUZ-WR12NA-U2	12,200	12,200	11,220	10,120	9,020	7,440	—	—	—
MSZ-WR18NA	MUZ-WR18NA-U2	18,000	18,000	18,000	16,560	14,580	12,780	—	—	—
MSZ-WR24NA	MUZ-WR24NA	26,000	24,440	22,360	20,020	17,680	15,600	—	—	—
MFZ-KJ09NA	MUFZ-KJ09NAHZ	11,000	11,000	11,000	11,000	11,000	11,000	9,130	—	7,260
MFZ-KJ12NA	MUFZ-KJ12NAHZ	13,000	13,000	13,000	13,000	13,000	13,000	10,790	—	8,450
MFZ-KJ15NA	MUFZ-KJ15NAHZ	18,000	18,000	18,000	18,000	18,000	18,000	14,940	—	13,860
MFZ-KJ18NA	MUFZ-KJ18NAHZ	21,000	21,000	21,000	21,000	21,000	21,000	18,480	—	15,960
MLZ-KP09NA2	SUZ-KA09NA2	12,000	10,680	9,240	7,800	6,480	5,040	3,720	—	—
MLZ-KP12NA2	SUZ-KA12NA2	15,400	13,700	11,850	10,010	8,310	6,460	4,770	—	—
MLZ-KP18NA2	SUZ-KA18NA2	20,000	17,800	15,400	13,000	10,800	8,400	6,200	—	—
MLZ-KP09NA2	SUZ-KA09NAHZ	12,000	12,000	12,000	12,000	12,000	12,000	8,520	—	5,160
MLZ-KP12NA2	SUZ-KA12NAHZ	15,000	15,000	15,000	15,000	15,000	15,000	10,650	—	6,450
MLZ-KP18NA2	SUZ-KA18NAHZ	18,600	18,600	18,600	18,600	18,600	18,600	13,200	—	7,990

M-Series Heating Capacity

Indoor Unit	Outdoor Unit	Outdoor Temperature Degrees								
		50° F	41° F	32° F	23° F	14° F	5° F	-4° F	-5° F	-13° F
SLZ-KF09NA	SUZ-KA09NA2	11,000	9,730	8,460	7,180	5,920	4,670	3,460	—	—
SLZ-KF12NA	SUZ-KA12NA2	13,000	11,510	10,000	8,490	6,990	5,520	4,080	—	—
SLZ-KF15NA	SUZ-KA15NA2	18,000	15,930	13,850	11,760	9,680	7,640	5,660	—	—
SLZ-KF18NA	SUZ-KA18NA2	19,700	17,440	15,150	12,870	10,600	8,370	6,190	—	—
SLZ-KF09NA	SUZ-KA09NAHZ	11,000	11,000	11,000	11,000	11,000	11,000	7,920	—	4,730
SLZ-KF12NA	SUZ-KA12NAHZ	13,800	13,800	13,800	13,800	13,800	13,800	9,936	—	5,934
SLZ-KF15NA	SUZ-KA15NAHZ	16,400	16,400	16,400	16,400	16,400	16,400	11,808	—	7,052
SLZ-KF18NA	SUZ-KA18NAHZ	18,800	18,800	18,800	18,800	18,800	18,800	13,536	—	8,084
SEZ-KD09NA4R1	SUZ-KA09NA2	12,000	10,620	9,230	7,840	6,450	5,090	3,770	—	—
SEZ-KD12NA4R1	SUZ-KA12NA2	15,000	13,280	11,540	9,800	8,070	6,370	4,710	—	—
SEZ-KD15NA4R1	SUZ-KA15NA2	18,000	15,930	13,850	11,760	9,680	7,640	5,660	—	—
SEZ-KD18NA4R1	SUZ-KA18NA2	21,600	19,120	16,620	14,110	11,620	9,170	6,790	—	—
SEZ-KD09NA4R1	SUZ-KA09NAHZ	12,500	12,500	12,500	12,500	12,500	12,500	9,000	—	5,375
SEZ-KD12NA4R1	SUZ-KA12NAHZ	15,000	15,000	15,000	15,000	15,000	15,000	10,800	—	6,450
SEZ-KD15NA4R1	SUZ-KA15NAHZ	15,000	15,000	15,000	15,000	15,000	15,000	10,800	—	6,450
SEZ-KD18NA4R1	SUZ-KA18NAHZ	21,600	21,600	21,600	21,600	21,600	21,600	15,552	—	9,288
PEAD-A09AA8	SUZ-KA09NA2	12,000	10,620	9,230	7,840	6,450	5,090	3,770	—	—
PEAD-A12AA8	SUZ-KA12NA2	15,000	13,280	11,540	9,800	8,070	6,370	4,710	—	—
PEAD-A15AA8	SUZ-KA15NA2	18,000	15,930	13,850	11,760	9,680	7,640	5,660	—	—
PEAD-A18AA8	SUZ-KA18NA2	21,600	19,120	16,620	14,110	11,620	9,170	6,790	—	—
PEAD-A24AA8	SUZ-KA24NA2	25,000	22,130	19,230	16,330	13,450	—	—	—	—
PEAD-A30AA8	SUZ-KA30NA2	30,000	26,560	23,080	19,600	16,140	—	—	—	—
PEAD-A36AA8	SUZ-KA36NA2	33,500	29,660	25,770	21,890	18,030	—	—	—	—
PEAD-A09AA8	SUZ-KA09NAHZ	12,000	12,000	12,000	12,000	12,000	12,000	8,640	—	5,160
PEAD-A12AA8	SUZ-KA12NAHZ	15,000	15,000	15,000	15,000	15,000	15,000	10,800	—	6,450
PEAD-A15AA8	SUZ-KA15NAHZ	18,000	18,000	18,000	18,000	18,000	18,000	12,960	—	7,740
PEAD-A18AA8	SUZ-KA18NAHZ	21,600	21,600	21,600	21,600	21,600	21,600	15,552	—	9,288

P-Series Heating Capacity

Indoor Unit	Outdoor Unit	Outdoor Temperature Degrees								
		50° F	41° F	32° F	23° F	14° F	5° F	-4° F	-5° F	-13° F
PLA-A12EA7	PUZ-A12NKA7	—	—	—	—	—	—	—	—	—
PLA-A18EA7	PUZ-A18NKA7	—	—	—	—	—	—	—	—	—
PLA-A24EA7	PUZ-A24NHA7	—	—	—	—	—	—	—	—	—
PLA-A30EA7	PUZ-A30NHA7	—	—	—	—	—	—	—	—	—
PLA-A36EA7	PUZ-A36NKA7	—	—	—	—	—	—	—	—	—
PLA-A42EA7	PUZ-A42NKA7	—	—	—	—	—	—	—	—	—
PLA-A24EA7	PUZ-HA24NHA1	26,000	26,000	26,000	26,000	26,000	26,000	—	23,140	20,800
PLA-A30EA7	PUZ-HA30NKA	32,000	32,000	32,000	32,000	32,000	32,000	—	28,480	25,600
PLA-A36EA7	PUZ-HA36NKA	38,000	38,000	38,000	38,000	38,000	38,000	—	33,820	30,400
PLA-A42EA7	PUZ-HA42NKA1	48,000	48,000	48,000	48,000	48,000	48,000	—	42,720	38,400
PKA-A12LA	PUZ-A12NKA7	14,000	14,000	14,000	14,000	14,000	14,000	12,460	—	11,200
PKA-A18LA	PUZ-A18NKA7	19,000	19,000	19,000	19,000	19,000	19,000	16,910	—	15,200
PKA-A24KA7	PUZ-A24NHA7	—	—	—	—	—	—	—	—	—
PKA-A30KA7	PUZ-A30NHA7	—	—	—	—	—	—	—	—	—
PKA-A36KA7	PUZ-A36NKA7	—	—	—	—	—	—	—	—	—
PKA-A24KA7	PUZ-HA24NHA1	26,000	26,000	26,000	26,000	26,000	26,000	—	23,140	20,800
PKA-A30KA7	PUZ-HA30NKA	32,000	32,000	32,000	32,000	32,000	32,000	—	28,480	25,600
PKA-A36KA7	PUZ-HA36NKA	38,000	38,000	38,000	38,000	38,000	38,000	—	33,820	30,400
PVA-A12AA7	PUZ-A12NKA7	—	—	—	—	—	—	—	—	—
PVA-A18AA7	PUZ-A18NKA7	—	—	—	—	—	—	—	—	—
PVA-A24AA7	PUZ-A24NHA7	—	—	—	—	—	—	—	—	—
PVA-A30AA7	PUZ-A30NHA7	—	—	—	—	—	—	—	—	—
PVA-A36AA7	PUZ-A36NKA7	—	—	—	—	—	—	—	—	—
PVA-A42AA7	PUZ-A42NKA7	—	—	—	—	—	—	—	—	—
PVA-A24AA7	PUZ-HA24NHA1	26,000	26,000	26,000	26,000	26,000	26,000	—	23,140	20,800
PVA-A30AA7	PUZ-HA30NKA	32,000	32,000	32,000	32,000	32,000	32,000	—	28,480	25,600
PVA-A36AA7	PUZ-HA36NKA	38,000	38,000	38,000	38,000	38,000	38,000	—	33,820	30,400
PVA-A42AA7	PUZ-HA42NKA1	48,000	48,000	48,000	48,000	48,000	48,000	—	42,720	38,400
PEAD-A12AA8	PUZ-A12NKA7	—	—	—	—	—	—	—	—	—
PEAD-A18AA8	PUZ-A18NKA7	—	—	—	—	—	—	—	—	—
PEAD-A24AA8	PUZ-A24NHA7	—	—	—	—	—	—	—	—	—
PEAD-A30AA8	PUZ-A30NHA7	—	—	—	—	—	—	—	—	—
PEAD-A36AA8	PUZ-A36NKA7	—	—	—	—	—	—	—	—	—
PEAD-A24AA8	PUZ-HA24NHA1	—	—	—	—	—	—	—	—	—
PEAD-A30AA8	PUZ-HA30NKA	—	—	—	—	—	—	—	—	—
PEAD-A36AA8	PUZ-HA36NKA	—	—	—	—	—	—	—	—	—
PEAD-A42AA7	PUZ-HA42NKA1	—	—	—	—	—	—	—	—	—
PCA-A24KA7	PUZ-A24NHA7	—	—	—	—	—	—	—	—	—

P-Series Heating Capacity

Indoor Unit	Outdoor Unit	Outdoor Temperature Degrees								
		50° F	41° F	32° F	23° F	14° F	5° F	-4° F	-5° F	-13° F
PCA-A30KA7	PUZ-A30NHA7	—	—	—	—	—	—	—	—	—
PCA-A36KA7	PUZ-A36NKA7	—	—	—	—	—	—	—	—	—
PCA-A42KA7	PUZ-A42NKA7	—	—	—	—	—	—	—	—	—
PCA-A24KA7	PUZ-HA24NHA1	26,000	26,000	26,000	26,000	26,000	26,000	—	23,140	20,800
PCA-A30KA7	PUZ-HA30NKA	32,000	32,000	32,000	32,000	32,000	32,000	—	28,480	25,600
PCA-A36KA7	PUZ-HA36NKA	38,000	38,000	38,000	38,000	38,000	38,000	—	33,820	30,400
PCA-A42KA7	PUZ-HA42NKA1	48,000	48,000	48,000	48,000	48,000	48,000	—	42,720	38,400
PAA-A18AA1	PUZ-A24NHA7	19,000	19,000	14,150	12,840	11,970	11,190	9,550	—	—
PAA-A18BA1	PUZ-A24NHA7	19,000	19,000	14,150	12,840	11,970	11,190	9,550	—	—
PAA-A24AA1	PUZ-A24NHA7	26,000	26,000	19,370	17,570	16,380	15,310	13,070	—	—
PAA-A24BA1	PUZ-A24NHA7	26,000	26,000	19,370	17,570	16,380	15,310	13,070	—	—
PAA-A30AA1	PUZ-A30NHA7	32,000	32,000	23,840	21,630	20,160	18,840	16,090	—	—
PAA-A30BA1	PUZ-A30NHA7	32,000	32,000	23,840	21,630	20,160	18,840	16,090	—	—
PAA-A36BA1	PUZ-A36NKA7	38,000	38,000	28,310	25,680	23,940	22,380	19,110	—	—
PAA-A36CA1	PUZ-A36NKA7	38,000	38,000	28,310	25,680	23,940	22,380	19,110	—	—
PAA-A42BA1	PUZ-A42NKA7	46,000	46,000	34,270	31,090	28,980	27,090	23,130	—	—
PAA-A42CA1	PUZ-A42NKA7	46,000	46,000	34,270	31,090	28,980	27,090	23,130	—	—
PAA-A24AA1	PUZ-HA24NHA1	26,000	26,000	26,000	26,000	26,000	26,000	23,140	—	20,800
PAA-A24BA1	PUZ-HA24NHA1	26,000	26,000	26,000	26,000	26,000	26,000	23,140	—	20,800
PAA-A30AA1	PUZ-HA30NKA	32,000	32,000	32,000	32,000	32,000	32,000	28,480	—	25,600
PAA-A30BA1	PUZ-HA30NKA	32,000	32,000	32,000	32,000	32,000	32,000	28,480	—	25,600
PAA-A36BA1	PUZ-HA36NKA	38,000	38,000	38,000	38,000	38,000	38,000	33,820	—	30,400
PAA-A36CA1	PUZ-HA36NKA	38,000	38,000	38,000	38,000	38,000	38,000	33,820	—	30,400

— = Data unavailable at print

MXZ Heating Capacity

Indoor Unit	Outdoor Temperature Degrees							
	50° F	41° F	32° F	23° F	14° F	5° F	-4° F	-13° F
MXZ-2C20NA4	22,000	22,000	18,920	15,840	12,980	9,900	—	—
MXZ-3C24NA4	25,000	25,000	24,000	20,750	17,250	13,250	—	—
MXZ-3C30NA4	28,600	28,600	28,020	24,310	20,300	15,730	—	—
MXZ-4C36NA4	36,000	36,000	33,480	29,160	24,120	18,720	—	—
MXZ-5C42NA4	45,000	45,000	41,850	36,450	30,150	23,400	—	—
MXZ-2C20NAHZ4	22,000	22,000	22,000	22,000	22,000	22,000	21,120	20,460
MXZ-3C24NAHZ4	25,000	25,000	25,000	25,000	25,000	25,000	23,750	22,500
MXZ-3C30NAHZ4	28,600	28,600	28,600	28,600	28,600	28,600	26,880	25,160
MXZ-SM36NAM	48,000	48,000	48,000	39,840	32,160	28,800	25,440	—
MXZ-SM48NAM	48,000	48,000	48,000	39,840	32,160	28,800	25,440	—
MXZ-SM60NAM	60,000	60,000	60,000	51,000	40,800	36,000	31,200	—
MXZ-SM36NAMHZ	36,000	36,000	36,000	36,000	36,000	36,000	30,960	26,640
MXZ-SM42NAMHZ	42,000	42,000	42,000	42,000	42,000	42,000	36,120	31,080
MXZ-SM48NAMHZ	48,000	48,000	48,000	48,000	48,000	48,000	41,280	35,520

Additional P-Series Information

Outlet Air Speed and Coverage Range*

Model	Airflow (CFM)	Air Speed (ft/sec)	Coverage Range (ft)
PCA-A24KA7	670	10.2	32
PCA-A30KA7	705	10.5	33
PCA-A36KA7	990	11.8	41
PCA-A42KA7	1,025	12.1	42
PKA-A12HA7	425	20.0	35
PKA-A18HA7	425	20.0	35
PKA-A24HA7	775	19.7	47
PKA-A30HA7	775	19.7	47
PKA-A36HA7	920	22.3	53
PLA-A12EA7	530	7.8	13
PLA-A18EA7	600	8.8	14
PLA-A24EA7	810	11.9	19
PLA-A30EA7	880	12.9	21
PLA-A36EA7	1,200	17.6	28
PLA-A42EA7	1,200	17.6	28



M-Series Model Reference Guide

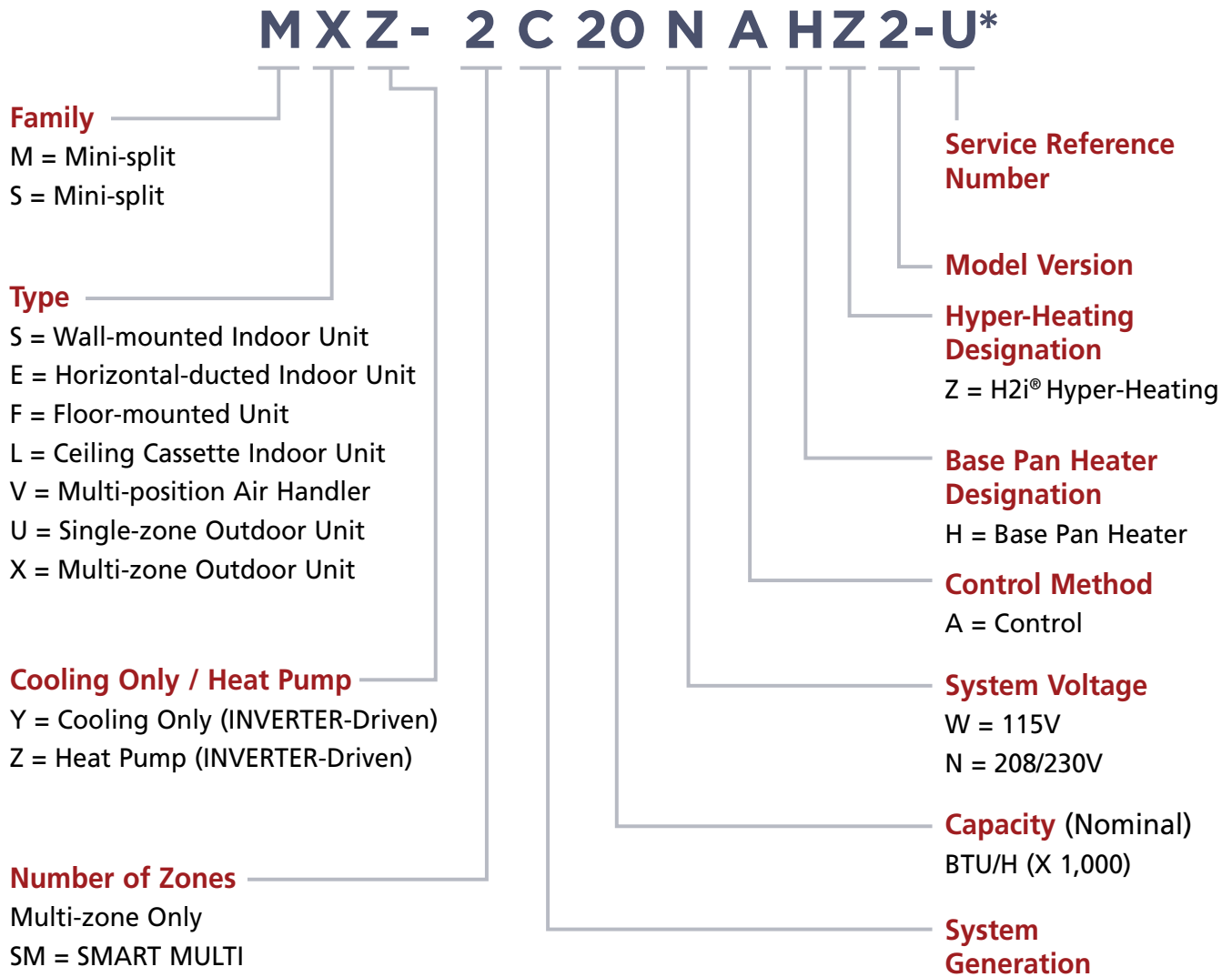

- Designed for residential applications
- User-friendly zoned cooling and heating solutions for single- or multi-room applications or the whole home
- Hyper-Heating INVERTER® (H2i®) outdoor units can provide high heating performance at lower ambient temperatures
- Many ENERGY STAR® certified models

P-Series Model Reference Guide

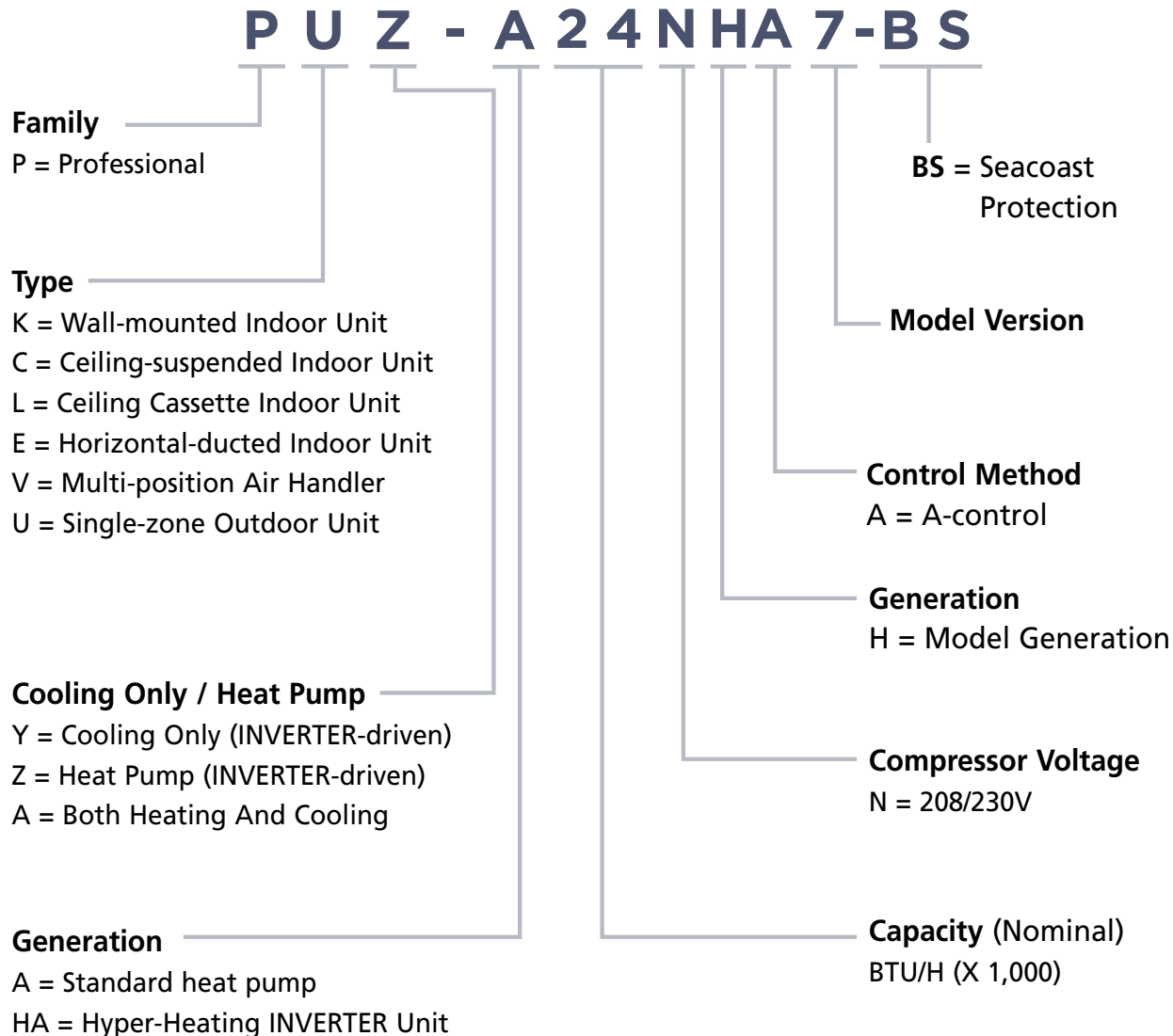

- Designed for light commercial installations. Ideal for applications requiring year-round, low ambient cooling such as computer, elevator and equipment rooms
- Hyper-Heating INVERTER® (H2i®) outdoor units can provide superior heating performance at lower ambient temperatures
- Long lineset lengths
- Outside air intake on PLA, PCA, PEAD and PVA models
- P-Series ducted units have higher static than most M-Series, allowing for design flexibility



mitsubishicomfort.com

MITSUBISHI ELECTRIC
TRANE HVAC US

© 2023 Mitsubishi Electric Trane HVAC US LLC. All rights reserved.

Mitsubishi Electric, Lossnay, and the three-diamond logo are trademarks of Mitsubishi Electric Corporation. CITY MULTI, kumo cloud, kumo station and H2i are registered trademarks of Mitsubishi Electric US, Inc. is a registered trademark of Trane Technologies plc. All other product names mentioned herein are trademarks or registered trademarks of their respective owners.

ENERGY STAR and the ENERGY STAR mark are registered trademarks owned by the United States Environmental Protection Agency.

Use of the AHRI Certified® mark indicates a manufacturer's participation in the certification program. For verification of certification for individual products, go to www.ahridirectory.org.

Specifications shown in this brochure are subject to change without notice. See complete warranty for terms, conditions and limitations. A copy is available from Mitsubishi Electric Trane HVAC US LLC.

Printed in the USA

ME_RS_0396_04-23