



# Landscaper Pro Slim Series

LPS-4414 • LPS-5614 • LPS-6814 • LPS-8014



**INSTALLATION/OWNERS MANUAL**  
FOR USE IN UNITED STATES AND CANADA

SERIAL NUMBER: \_\_\_\_\_

# MODERN FLAMES

**LANDSCAPE PRO SERIES SLIM  
LPS-4414 • LPS-5614 • LPS-6814 • LPS-8014  
SAFETY INFORMATION AND OPERATIONS MANUAL**



**Read these instructions completely before beginning installation. Failure to follow them could cause a heater malfunction resulting in serious injury and/or property damage.**

**WARNING: All electric heaters have hot and arcing or sparking parts inside. Do not use it in areas where gasoline, paint or flammable liquids are or are stored.**

**This fireplace meets the construction and safety standards of H.U.D. for application in manufactured homes when installed according to these instructions.**

**INSTALLER: Leave this manual with the appliance.  
CONSUMER: Retain this manual for future reference.**

# USER INSTRUCTIONS

## TABLE OF CONTENTS

Important Instructions.....	3	Service Parts.....	10
Power Data.....	4	Troubleshooting.....	12
Product Guide.....	4	Frequently Asked Questions.....	13
Box Contents.....	5	Cleaning and Maintenance Instructions.....	14
Installation.....	6	Wiring Diagram.....	14
Operation.....	9		

## IMPORTANT INSTRUCTIONS

When using electrical heaters, basic precautions should always be followed to reduce the risk of fire, electric shock and injury to persons, including the following:

**WARNING: Improper installation, adjustment, alteration, service or maintenance can cause injury or property damage. Refer to this manual. For assistance or additional information, consult a qualified installer.**

**CAUTION: Do not expose the heater to the elements (such as rain, etc).**

**Do not place clothing or other flammable material on or near firebox. Never place any objects on the fireplace.**

**Carefully supervise young children when they are in the room with fireplace.**

**Fireplace becomes very hot when running. Keep children and adults away from hot surfaces to avoid burns or clothing ignition. Fireplace will remain hot for a time after shutdown. Allow surfaces to cool before touching.**

 **CAUTION: In order to avoid overheating, do not cover the heater.**

1. Read all instructions before installing or using this heater.
2. This heater is hot when in use. To avoid burns, do not let bare skin touch hot surfaces. Keep combustible materials, such as furniture, pillows, bedding, papers, clothes, and curtains at least 3 feet (0.9m) from the front of the heater and keep them away from the sides and rear.
3. Extreme caution is necessary when any heater is used by or near children or disabled people and whenever the heater is left operating and unattended.
4. Do not operate any heater after it malfunctions, has been dropped, or damaged in any manner. Disconnect power at service panel and have heater inspected by an authorized technician or a reputable electrician before using.
5. Do not use outdoors.
6. To disconnect heater, turn controls to off and turn off power to heater circuit at main disconnect panel.
7. Do not insert or allow foreign objects to enter any ventilation or exhaust opening as this may cause an electric shock or fire, or damage the heater.
8. To prevent a possible fire, do not block air intakes or exhaust in any manner.
9. A heater has hot and arcing or sparking parts inside. Do not use it in areas where gasoline, paint or flammable vapors or liquids are used or stored.
10. Use this heater only as described in this manual. Any other use not recommended by the manufacturer may cause fire, electric shock or injury to persons.
11. **SAVE THESE INSTRUCTIONS**

## POWER DATA

	LPS-4414	LPS-5614	LPS-6814	LPS-8014
Voltz/HZ Amps	AC 120V 60Hz 14 Amps	AC 120V 60Hz 14 Amps	AC 120V 60Hz 14 Amps	AC 120V 60Hz 14 Amps
Heater	AC 120V 1500W	AC 120V 1500W	AC 120V 1500W	AC 120V 1500W
Lamps	LED DC 12V	LED DC 12V	LED DC 12V	LED DC 12V
Rotor Motor	AC120V/60Hz 40mA 3.7W 18/15RPM CCW	AC120V/60Hz 40mA 3.7W 18/15RPM CCW	AC120V/60Hz 40mA 3.7W 18/15RPM CCW	AC120V/60Hz 40mA 3.7W 18/15RPM CCW
Shipping Size	46 1/4" x 26" x 8"	58 1/4" x 26" x 8"	70 1/4" x 26" x 8"	82 1/4" x 26" x 8"

## PRODUCT GUIDE

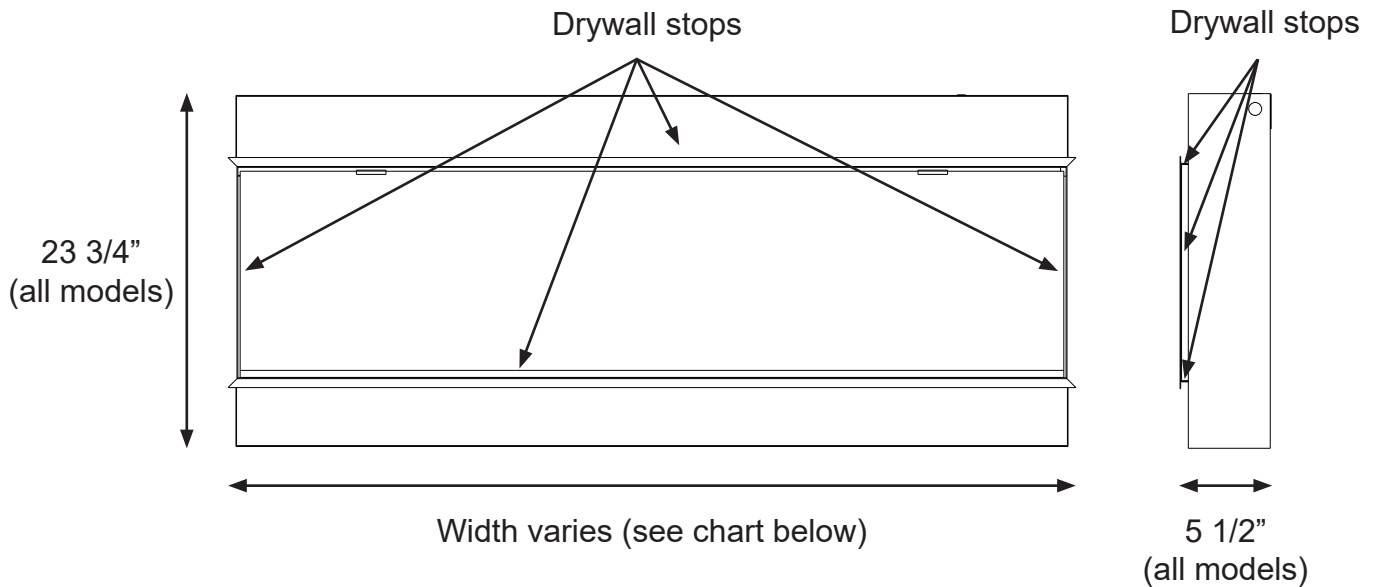

Model	Viewing Area	Firebox Dimensions	Framing Dimensions
LPS-4414	43 3/4" W x 14" H	44 1/4" W x 23 3/4" H x 5 1/2" D	44 1/2" W x 24 1/8" H x 6" D
LPS-5614	55 3/4" W x 14" H	56 1/4" W x 23 3/4" H x 5 1/2" D	56 1/2" W x 24 1/8" H x 6" D
LPS-6814	67 3/4" W x 14" H	68 1/4" W x 23 3/4" H x 5 1/2" D	68 1/2" W x 24 1/8" H x 6" D
LPS-8014	79 3/4" W x 14" H	80 1/4" W x 23 3/4" H x 5 1/2" D	80 1/2" W x 24 1/8" H x 6" D

# INSTALLATION

## BOX CONTENTS

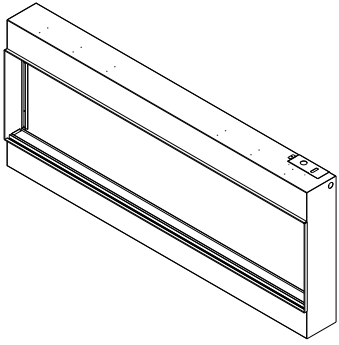

1 Fire Unit



1 Remote

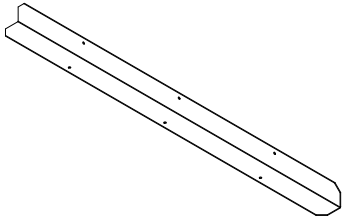

4 L-Metal Mounting Brackets

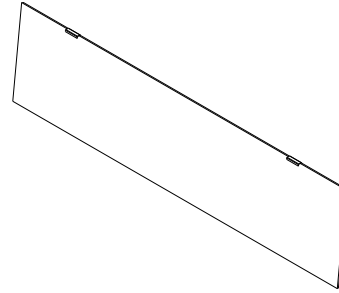

1 Glass Face

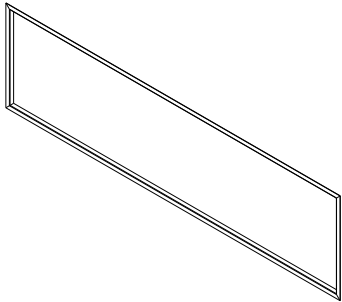

1 Trim Kit

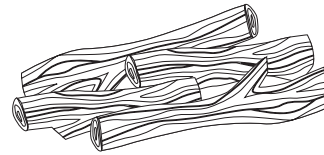

Logs



1 Owner's Manual

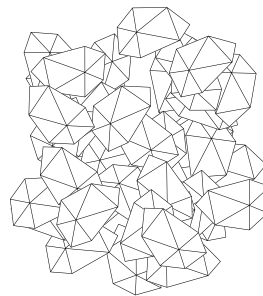

Acrylic Media

## INSTALLATION

**WARNING:** If the information in these instructions is not followed exactly, a fire or explosion may result causing property damage, personal injury or death.

**WARNING - RISK OF FIRE!**

To prevent a possible fire, do not block air intake or exhaust in any manner. Do not use on soft surfaces where openings may become blocked.

**WARNING - RISK OF FIRE!**

Do not blow or place insulation against the firebox.

To reduce the risk of fire do not store or use gasoline or other flammable vapors in the vicinity of this or any other heater.

**CAUTION:** Keep combustible materials, such as furniture, pillows, bedding, papers, clothes and curtains at least 3 feet (0.9m) from the front of the heater and keep them away from the sides and rear.

**CAUTION:** Wear gloves and safety glasses for protection during installation and maintenance.

**Installing fireplace**

Select a suitable location that is not susceptible to moisture and is a safe distance from drapes, furniture and high traffic areas. A qualified electrician should add a dedicated flexible 15 amp 120 volt circuit per local building codes. Note: Follow all national and local electrical codes.

This fireplace can be installed fully recessed or half recessed.

To prepare for installation, connect the hard wire to the terminal block according to the diagram below. Choose any connector type according to local building code.

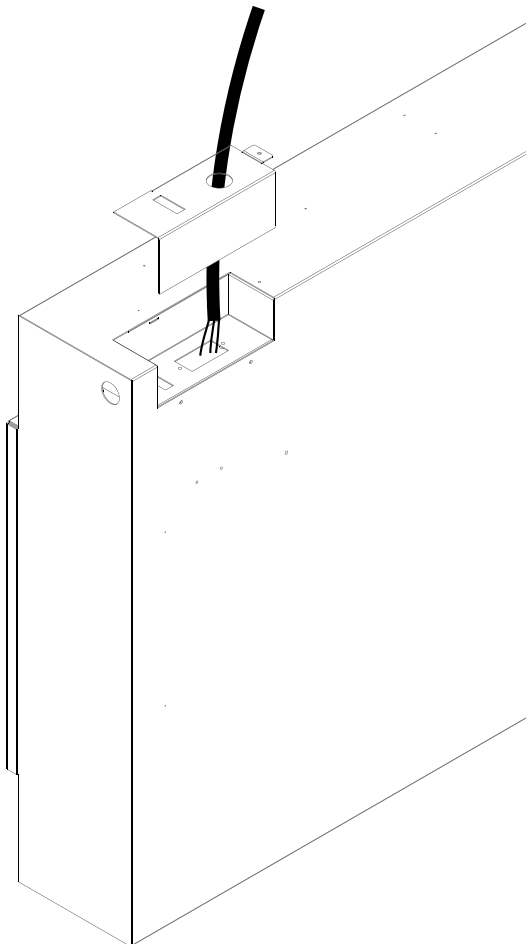

To be performed by a qualified electrician according to local building codes.

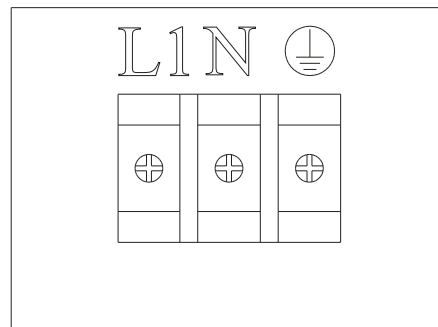
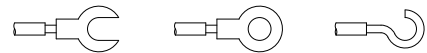

L1 - Line 1

N - Neutral

 - Ground

# INSTALLATION

## Fully recessed installation

Model	W	H	D
LPS-4414	44 1/2"	24 1/8"	6"
LPS-5614	56 1/2"	24 1/8"	6"
LPS-6814	68 1/2"	24 1/8"	6"
LPS-8014	80 1/2"	24 1/8"	6"

1. This installation is optimized for a 2x6 framed wall. Prepare the framed opening according to the chart above. Provide a dedicated flexible 15 amp 120 volt circuit for hard wire installation.

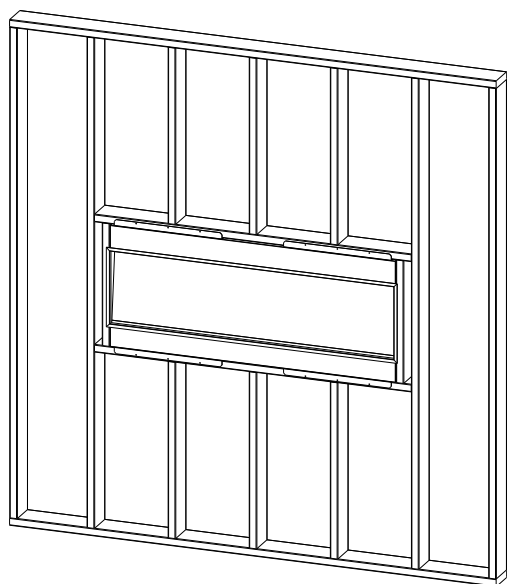

4. Mask the exposed fire unit during the drywall process. Install drywall to the drywall stops on the perimeter of the fire box. For more information on the drywall stops see the Product Guide on page 4. Decorate as desired.

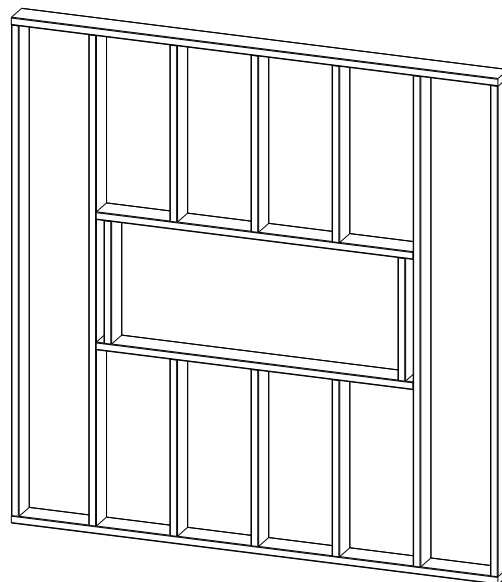

2. Install L Metal Nailing Flanges to the fireplace.
3. Install the fire unit in the framed opening with a minimum 1 1/4 drywall screws to secure the unit.

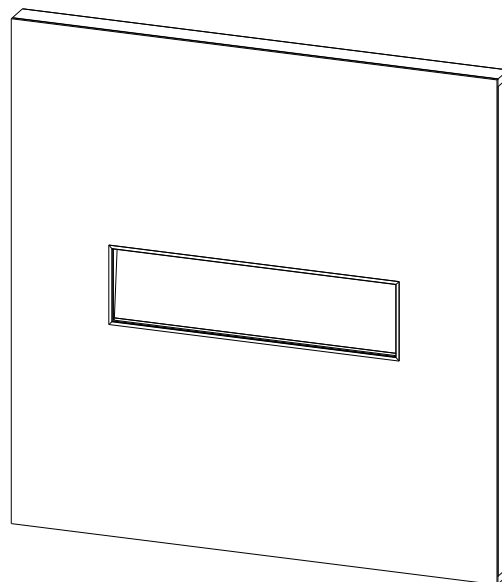

## Half recessed installation

1. This installation is optimized for a 2x4 framed wall. Prepare the framed opening according to the chart on page 7. Provide a dedicated flexible 15 amp 120 volt circuit for hard wire installation.

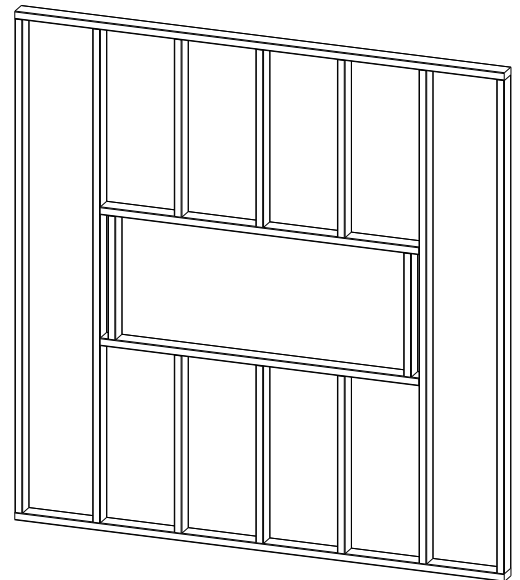
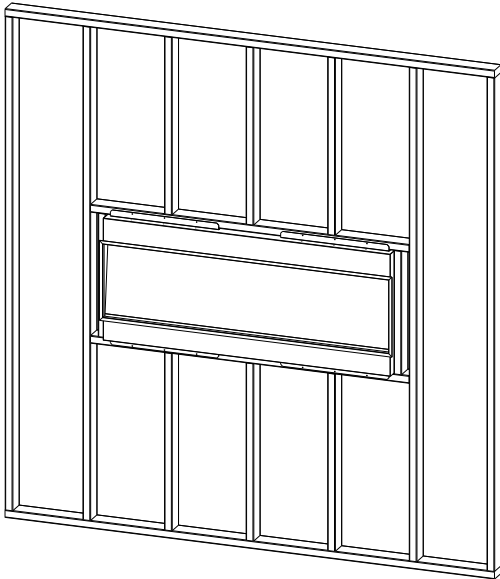

2. Install L Metal Nailing Flanges to the fireplace.
3. Install the fire unit in the framed opening with a minimum 1 ¼ drywall screws to secure the unit.

4. Mask the exposed fire unit during the drywall process. Install drywall to the perimeter of the fire box. The unit can be covered with a custom facade or optional Slim Cabinet (shown in diagram). Decorate as desired.

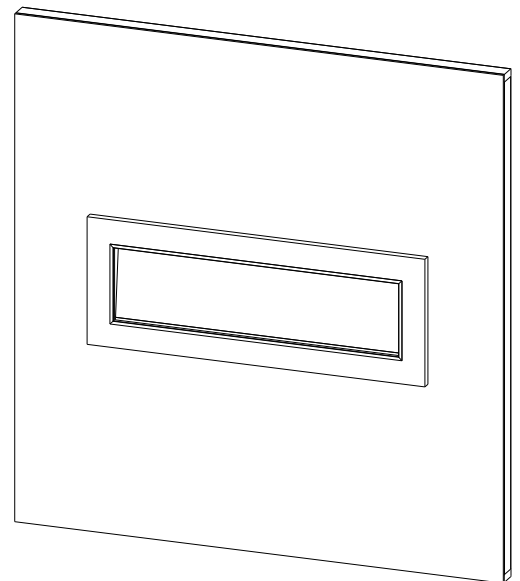

## Installing Optional Wall Mounted Touch Control

1. Locate 2-gang low voltage bracket within 20 feet of fireplace. Install according to manufacturer's instructions.
2. Remove glass face (attached with magnets) from metal bracket.
3. Attach the metal bracket to the low voltage bracket with the included screws.
4. Insert batteries (2 AAA) and replace the glass face.













# OPERATION

## OPERATION

The unit has a main power switch just in front of the glass on the right hand side. A hand-held remote is included.



-  **Power** This will cycle the machine on and off. Upon cycling power on, the machine will return to the settings it had when it was cycled off.
-  **Reset** If the fireplace is on, this button will act as a reset and bring all colors back to the default Modern Flames orange/yellow.
-  **Heat** This will cycle the heater between high, low and off.
-  **Fade** All zones of the fireplace will start the slow fade between colors.
-  **Sync** Pressing the sync button will change all the colors of the fireplace) Flame, Ember Bed and Downlight) to match the current color of the flame setting.
-  **Flame** This is a zone setting. Touching this button will allow you to change the color and brightness of the flame by using the RGB wheel and brightness slider.
-  **Ember Bed** This is a zone setting that controls the color and brightness of the ember bed.
-  **Downlight** This is a zone setting that controls the color and brightness of the downlight.









### Pairing remote:

To pair remote, turn off the fire unit at the main power switch for 30 seconds. Hold the On/Off button on the remote while flipping the main power switch back to on. When the fire unit powers up, the remote will be paired.

### Power indicator lights for wall switch as well as upper right corner of the main unit

-   





When the switch turns on, this orange pilot lamp turns on. It shows the fire is energized.
-   



The status light above shows that the power is on and the heater is on low.
-   

The status light above shows that the power is on and the heater is on high.

### Manual Controls

The unit has manual controls located next to the power switch, just in front of the glass on the top right side.

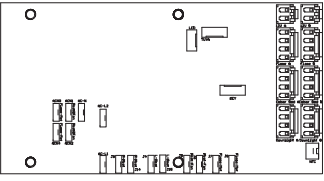
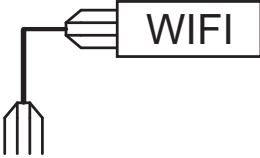
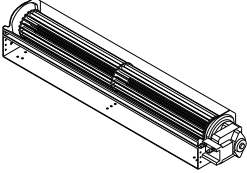
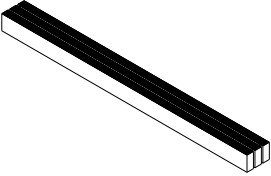
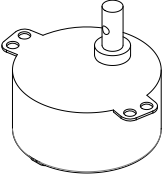
-  **Power**  
Turns unit on/off
-  **Heat**  
Cycles heat low/high/off
-  **Color**  
Changes fireplace color
-  **Reset**  
Resets unit

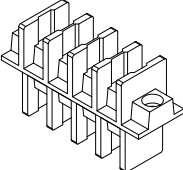
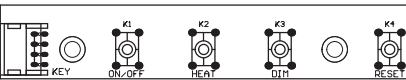
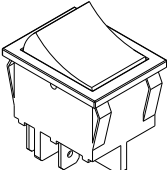
<b>SERVICE PARTS</b>		
ITEM	PHOTO	DESCRIPTION
MF-PRO-PCB		PRINTED CIRCUIT BOARD CONTROLS LOW VOLTAGE AND HIGH VOLTAGE FUNCTIONS AND TRANSFORMER
MF-PRO-WIFI		WIFI BOARD
MF-PRO-HF		HEATER FAN 120 V
MF-PRO-PTC		PTC HEATER 120/240 V 1500/3000 WATTS
MFSM120		SPINDLE MOTOR 120 V 50-60 HZ
MF-PRO-RC		PRO SERIES RF REMOTE CONTROL
MF-PRO-WTC		<b>OPTIONAL</b> WALL MOUNTED TOUCH CONTROL ASSEMBLY
MF-PRO-TB		TERMINAL BLOCK 120/240 V
MF-PRO-MTC		MANUAL TOUCH CONTROL BOARD
MFPS2		20 AMP POWER SWITCH

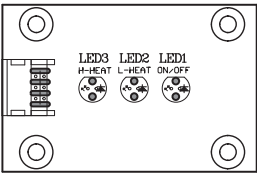
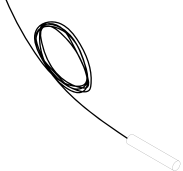
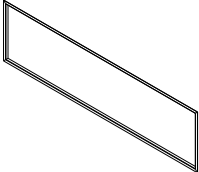
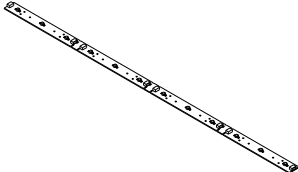
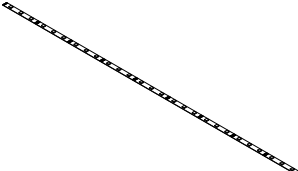
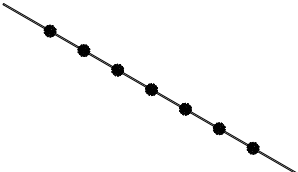
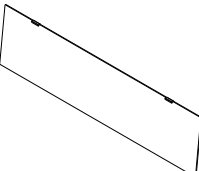
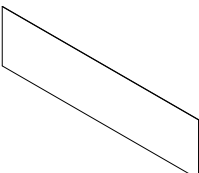
<b>SERVICE PARTS</b>		
ITEM	PHOTO	DESCRIPTION
MF-PRO-PIB		POWER INDICATOR BOARD
MF-PRO-NTC		THERMOSTAT SENSOR
MF-LPS-TK-44		TRIM KIT
MF-LPS-TK-56		
MF-LPS-TK-68		
MF-LPS-TK-80		
MF-LPS-F/LED-44		RGB FLAME LED BAR
MF-LPS-F/LED-56		
MF-LPS-F/LED-68		
MF-LPS-F/LED-80		
MF-LPS-EB/DL-44		RGB EMBER BED/DOWNLIGHT LED STRIP
MF-LPS-EB/DL-56		
MF-LPS-EB/DL-68		
MF-LPS-EB/DL-80		
MF-LPS-SR-44		SPINDLE ROD FOR FLAME OR EMBER BED
MF-LPS-SR-56		
MF-LPS-SR-68		
MF-LPS-SR-80		
MF-LPS-GF-44		FRONT GLASS
MF-LPS-GF-56		
MF-LPS-GF-68		
MF-LPS-GF-80		
MF-LPS-PP-44		POLY SCREEN
MF-LPS-PP-56		
MF-LPS-PP-68		
MF-LPS-PP-80		

**TROUBLESHOOTING**

<b>Problem</b>	<b>Possible Cause</b>	<b>Corrective Action</b>
Nothing comes on (touch screen, etc.)	A. Breaker tripped or circuit has no power	A. Reset breaker, test circuit for power
	B. Internal component is frozen and needs to be reset	B. Turn power off at the main breaker for 20 seconds. Turn power back on.
	C. Loose connection	C. Look for loose connection
	D. Main power switch is off	D. Verify main power switch is in the on position
	E. Defective component	E. Replace motherboard, touch control or main power switch
Fireplace turns off and will not turn back on	A. Fireplace has overheated and safety disc has snapped or circuit breaker has tripped	A. Turn the main breaker to the "off" position for 30 seconds. Next flip the breaker back into the "on" position.
Can operate fireplace functions with manual controls but not remote control	A. Low Batteries	A. Replace batteries in remote control with - CR2025
	B. Remote not paired properly	B. To pair remote, turn off the fire unit at the main power switch for 30 seconds. Hold the On/Off button on the remote while flipping the main power switch back to on. When the fire unit powers up, the remote will be paired.
	C. Remote control defective	C. Replace remote control
Heater does not provide heat when on	A. Wiring is loose	A. Disconnect unit from power source and inspect for loose connections
	B. Heater core is defective	B. Replace Heater Core
Flame is not visible when unit is turned on	A. Wiring is loose	A. Disconnect unit from power source and inspect for loose connections
	B. LEDs mounted incorrectly	B. Verify LEDs are mounted to bracket
	C. LEDs defective	C. Replace LEDs
	D. Motherboard is defective	D. Replace motherboard

## MAINTENANCE

Problem	Possible Cause	Corrective Action
Fireplace lights up but there is no flame image or flame image frozen	A. Wiring for motor is loose	A. Disconnect unit from power source and inspect for loose connections from motor
	B. Spindle rod came loose from motor	B. Reconnect spindle rod to the motor
	C. Motor is defective	C. Replace motor
Fireplace is squeaking when flame image is on	A. Fireplace spindle/rod is contacting to metal	A. Apply lithium grease or any standard grease to contacts with rod and metal & verify spindle rod is spinning freely
	B. Motor is defective	B. Replace motor

### FREQUENTLY ASKED QUESTIONS

Q. How do you change the optional Wall Touch Control to Fahrenheit/Celsius?

A. Long press on the up and down arrows on the fire unit to toggle between Fahrenheit and Celsius.

Q. What distance can the remote be used from the fireplace?

A. Optimal distance for the remote control is within 20 feet.

Q. Can you turn on the fireplace via the manual control and off via the remote (or vice versa)?

A. Yes.

Q. Can the fireplace be installed outside?

A. No. Please review the entire safety chapter before installing this fireplace.

Q. Does the fireplace need to be on a dedicated 15 amp circuit?

A. Yes.

Q. What thickness of sheetrock should be used for the recessed installation?

A. 1/2" or 5/8", thinner is recommended for tile façade.

Q. How often do the batteries in the remote need to be replaced?

A. Annually, possibly more with heavy use.

Q. Is there a remote receiver in the fireplace that requires batteries?

A. No, only the actual remote requires batteries. The rest of the fireplace runs entirely off of the main power supply.

## CLEANING AND MAINTENANCE INSTRUCTIONS

There is very little maintenance involved with your electric fireplace. Please follow the few points below:

- On a semi-annual basis unplug the machine from it's power source, wait for the heating element to cool and dust the fire unit with a dry cloth. Be careful not to brush any wires that may be exposed as you do this.
- To clean the glass face of the fireplace simply use your desired glass cleaner with paper towels.
- To clean the air inlets/outlets, wipe with a soft cloth or the nozzle of a vacuum cleaner
- Dust can easily build up around the heater area inside the fire unit, on the left and right sides. Take particular care to clean this area on a regular basis to prevent buildup.
- For long periods of inactivity, please unplug the fireplace and ensure the surrounding area remains dry.

### WIRING DIAGRAM

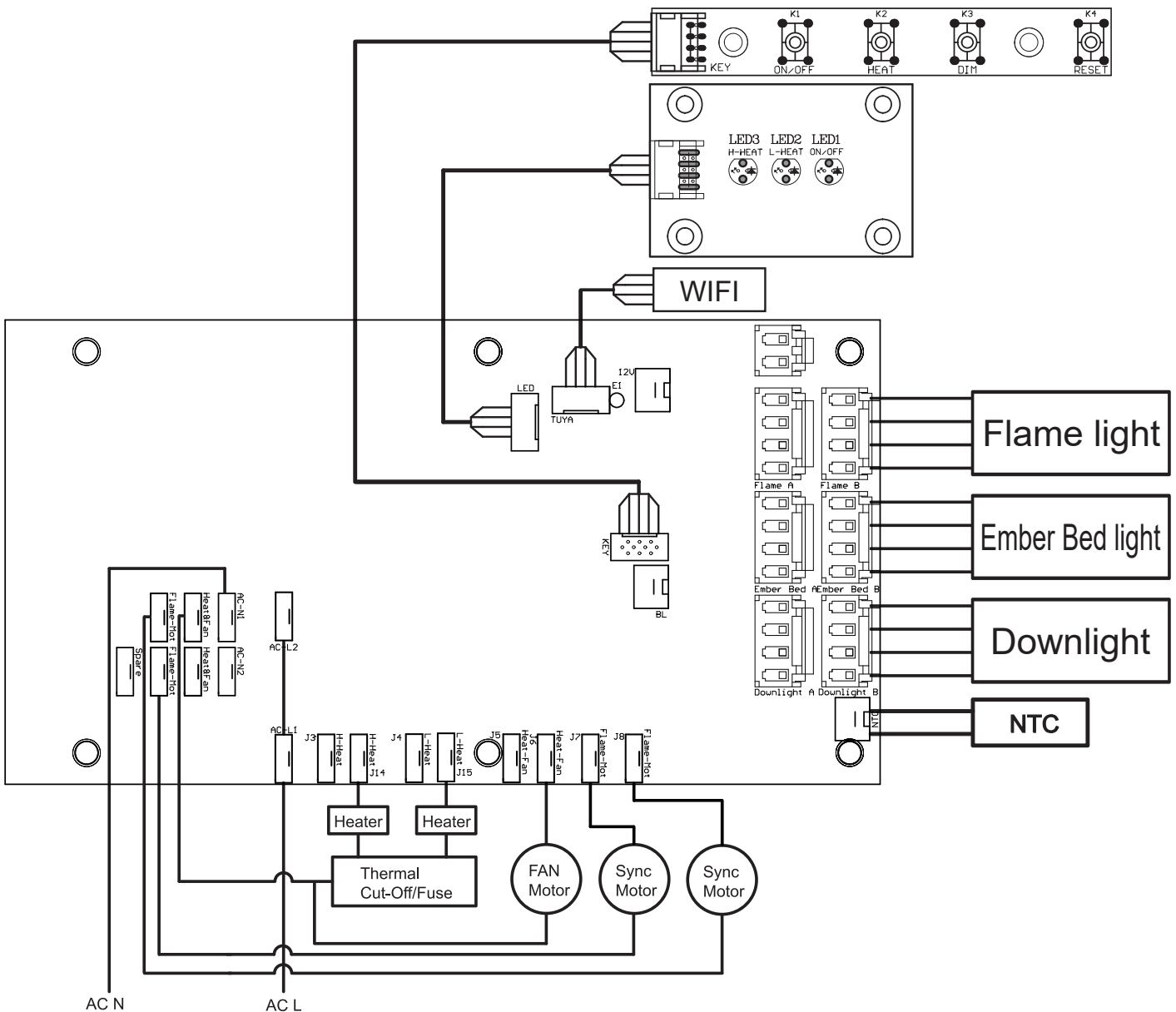



©2019

MODERN  FLAMES

[www.modernflames.com](http://www.modernflames.com)  
Please dispose of properly.

